

This drawing is confidential and must not be reproduced or used without the consent of EXM

Ce dessin est confidentiel et ne doit pas être reproduit ou utilisé sans le consentement de EXM

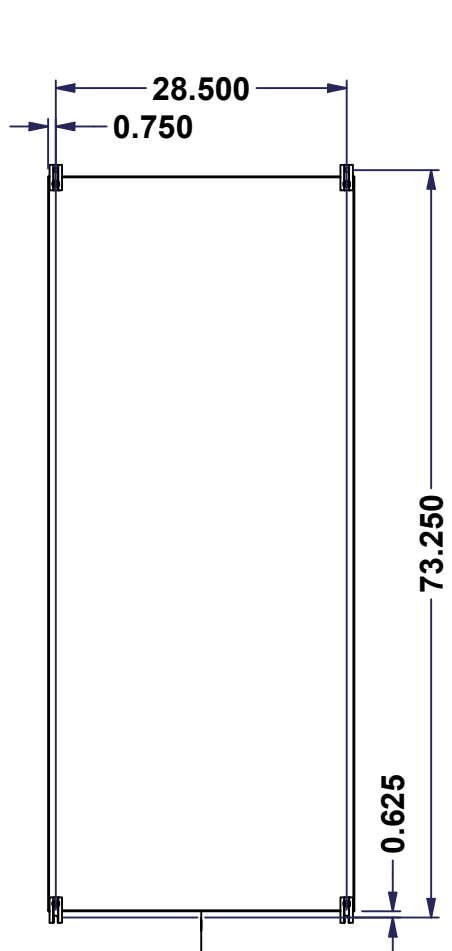

TOP



BACK

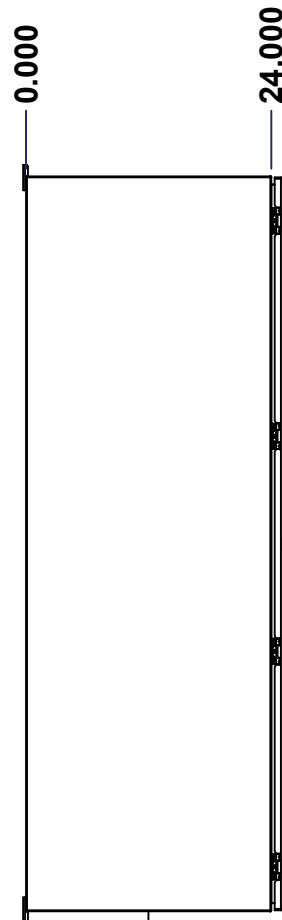

LEFT

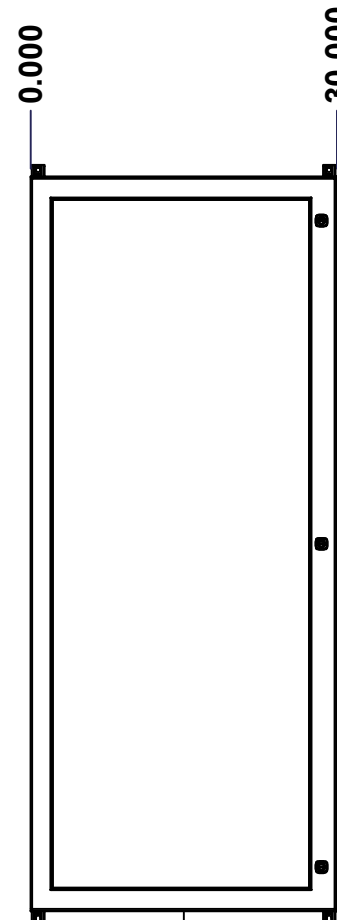

FRONT

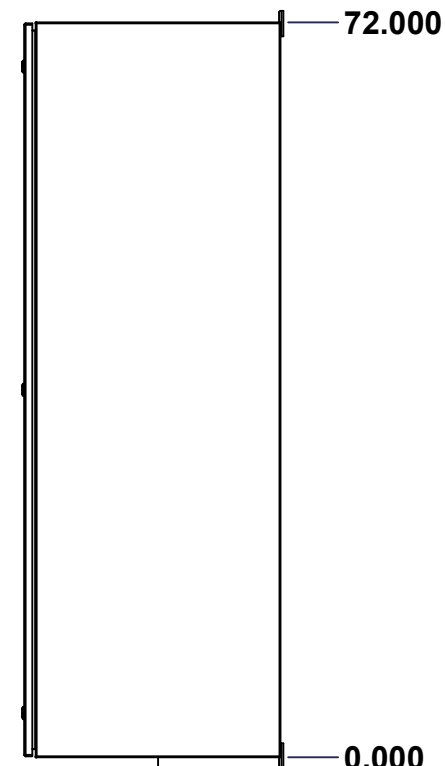

RIGHT

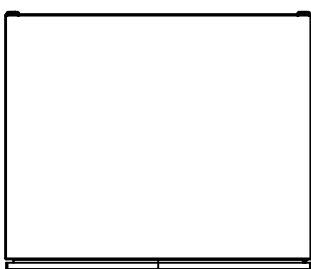

BOTTOM

No.	Revisions	Date	By/Par

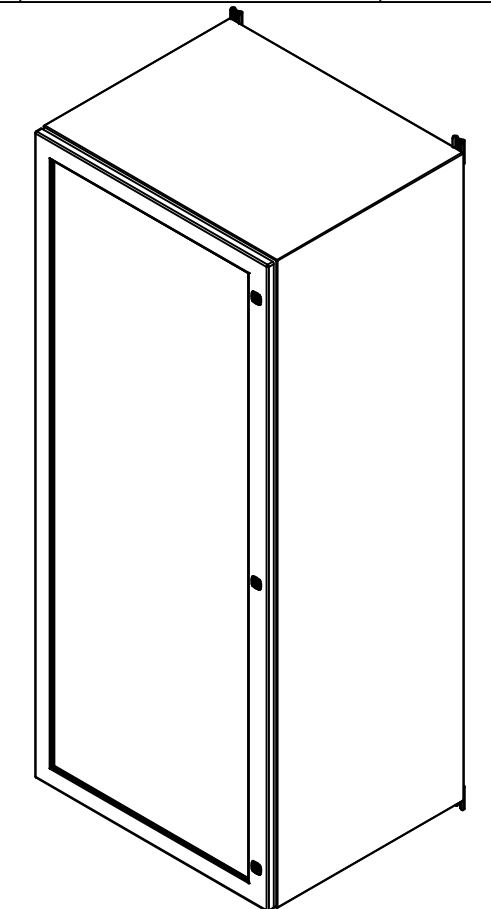

Isometric View

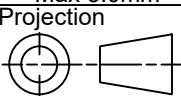

**GRAIN DIRECTION:
TOP/BOTTOM: HORIZONTAL
LEFT/RIGHT/BACK/FRONT: VERTICAL**

 Tél: (450) 979-4373 Fax: (450) 979-4626 www.exmweb.com		Flatness Aplatissement Max 3.0mm Projection 
Customer Client	Date	
Drawn By Dessiné Par	BoxCad: BoxCad	Date 05-Jun-23
Material Matière	14 Ga Stainless Steel 304 (1.7mm)	
Color Couleur	Unpainted	Finish Fini Brushed
Description	Detail Rev.	
5412ESSW 72" x 30" x 24" Assembly		
Part Number Numéro Pièce	Rev. 0	1 / 15

SEE BILL OF MATERIAL ON LAST PAGE

5412ESSW723024TH

This drawing is confidential and must not be reproduced or used without the consent of EXM

Ce dessin est confidentiel et ne doit pas être reproduit ou utilisé sans le consentement de EXM

NOTE	
ITEM	DESCRIPTION
1	NEMA 4X Enclosure
2	C/W Standard ground studs on box and cover
3	W/O Standard door stiffener
4	C/W Standard inner panel (Included)
5	C/W Standard inner panel mounting studs
6	C/W 885 ESMF4_OPEN Sold separately (Installed)
7	C/W 885 ESMF4_CLOSE Sold separately (Installed)
8	C/W R5 Insulation (Installed by EXM)

No.	Revisions	Date	By/Par

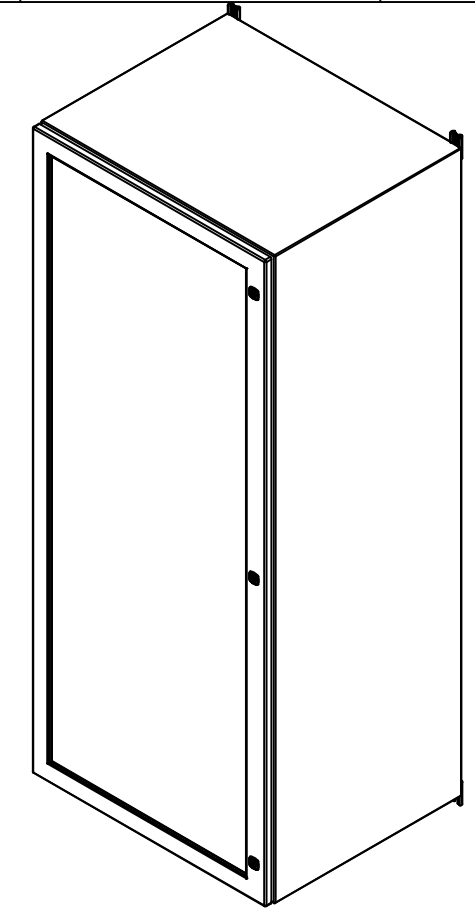

Isometric View



PACKING		
ITEM	QTY	DESCRIPTION
Cardboard sleeve	2	Top and Bottom
Cardboard strip	2	Between back of enclosure and inner panel
Plastic bag	1	To protect cover surface and inside gasket
Cardboard corner	4	To reinforced for the plastic strap tightening
Plastic strap - Black	2	To Squeeze the 2 cardboard sleeve together
Packaging label	3	White label with PN
Plastic strap- Green	2	To secure the enclosure to the wood pallet
Wood Pallet	1	2" deeper and 3" larger than enclosure size

6	STK-Q-00600	2	M12 to M8 Adaptor
1	881 SP7230G	0	881 SP - Inner Panel
1	STK-K-01800	5	5412 ES Accessory Kit
1	5412ESSW723024THC	0	5412ESSW 72" x 30" Cover
1	5412ESSW723024THB	0	5412ESSW 72" x 30" x 24" Body
4	STK-Q-04051-08	1	M6 x 8mm Stainless Steel Hexagon Socket Head Machine Screw with Nyseal
Qty	Part Number	Rev	Description
Parts List			

<p>Tél: (450) 979-4373 Fax: (450) 979-4626 www.exmweb.com</p>	Flatness Aplatissement	Max 3.0mm
	Projection	
Customer Client	Date	
Drawn By Dessiné Par	BoxCad: BoxCad	Date 05-Jun-23
Material Matière	14 Ga Stainless Steel 304 (1.7mm)	
Color Couleur	Unpainted	Finish Fini Brushed
Description	Detail Rev.	
5412ESSW 72" x 30" x 24" Assembly		
Part Number Numéro Pièce	Rev.	2
5412ESSW723024TH	0	15

This drawing is confidential and must not be reproduced or used without the consent of EXM

Ce dessin est confidentiel et ne doit pas être reproduit ou utilisé sans le consentement de EXM

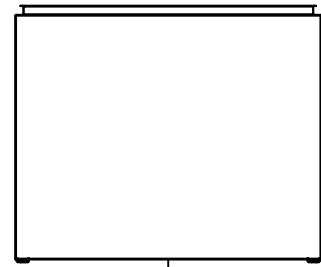

TOP

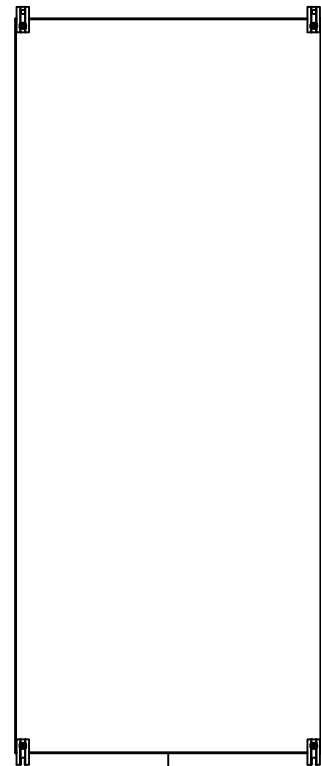

BACK

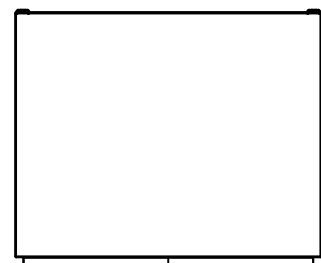

BOTTOM

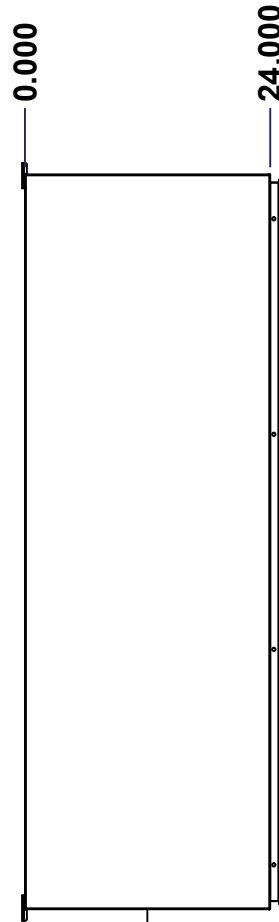

LEFT

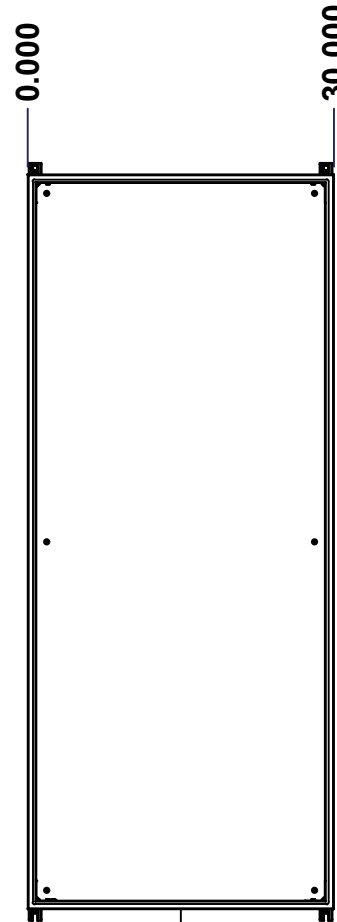

FRONT

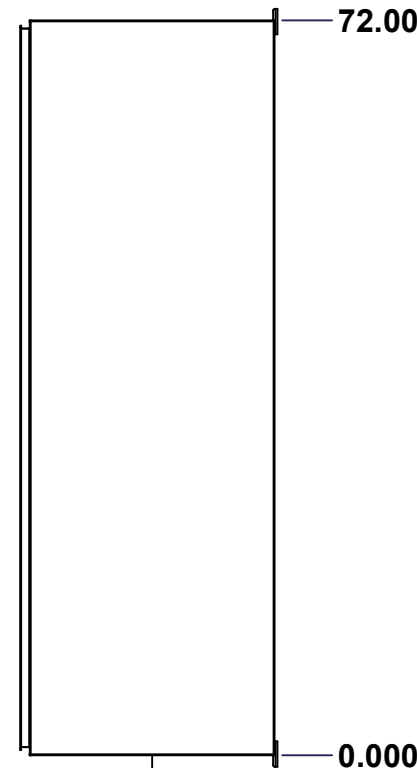

RIGHT

No.	Revisions	Date	By/Par

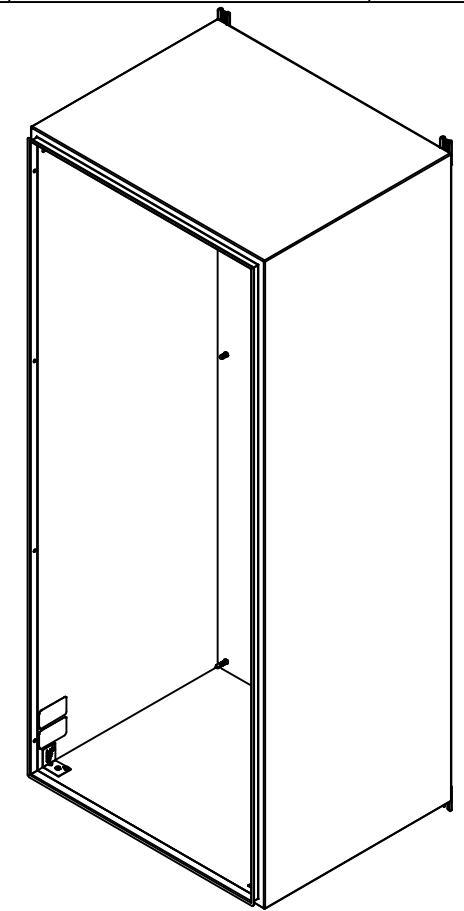

Isometric View



Tél: (450) 979-4373
 Fax: (450) 979-4626
www.exmweb.com

Flatness
Aplatissement

Max 3.0mm

Projection

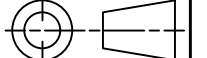

Customer Client	Date
Drawn By Dessiné Par BoxCad: BoxCad	Date 05-Jun-23
Material Matière 14 Ga Stainless Steel 304 (1.7mm)	
Color Couleur Unpainted	Finish Fini Brushed
Description 5412ESSW 72" x 30" x 24" Body	Detail Rev.
Part Number Numéro Pièce 5412ESSW723024THB	Rev. 3
	0

SEE BILL OF MATERIAL ON LAST PAGE

This drawing is confidential and must not be reproduced or used without the consent of EXM

Ce dessin est confidentiel et ne doit pas être reproduit ou utilisé sans le consentement de EXM

STANDARD FEATURES ARE NOT LISTED IN THIS HOLE TABLE			
HOLE TABLE - TOP VIEW (CUSTOM FEATURE ONLY)			
CUT-OUT	XDIM	YDIM	DESCRIPTION
1	2.000	22.500	INSUL. STUD M6 x 18mm (Inside)
2	28.000	22.500	INSUL. STUD M6 x 18mm (Inside)

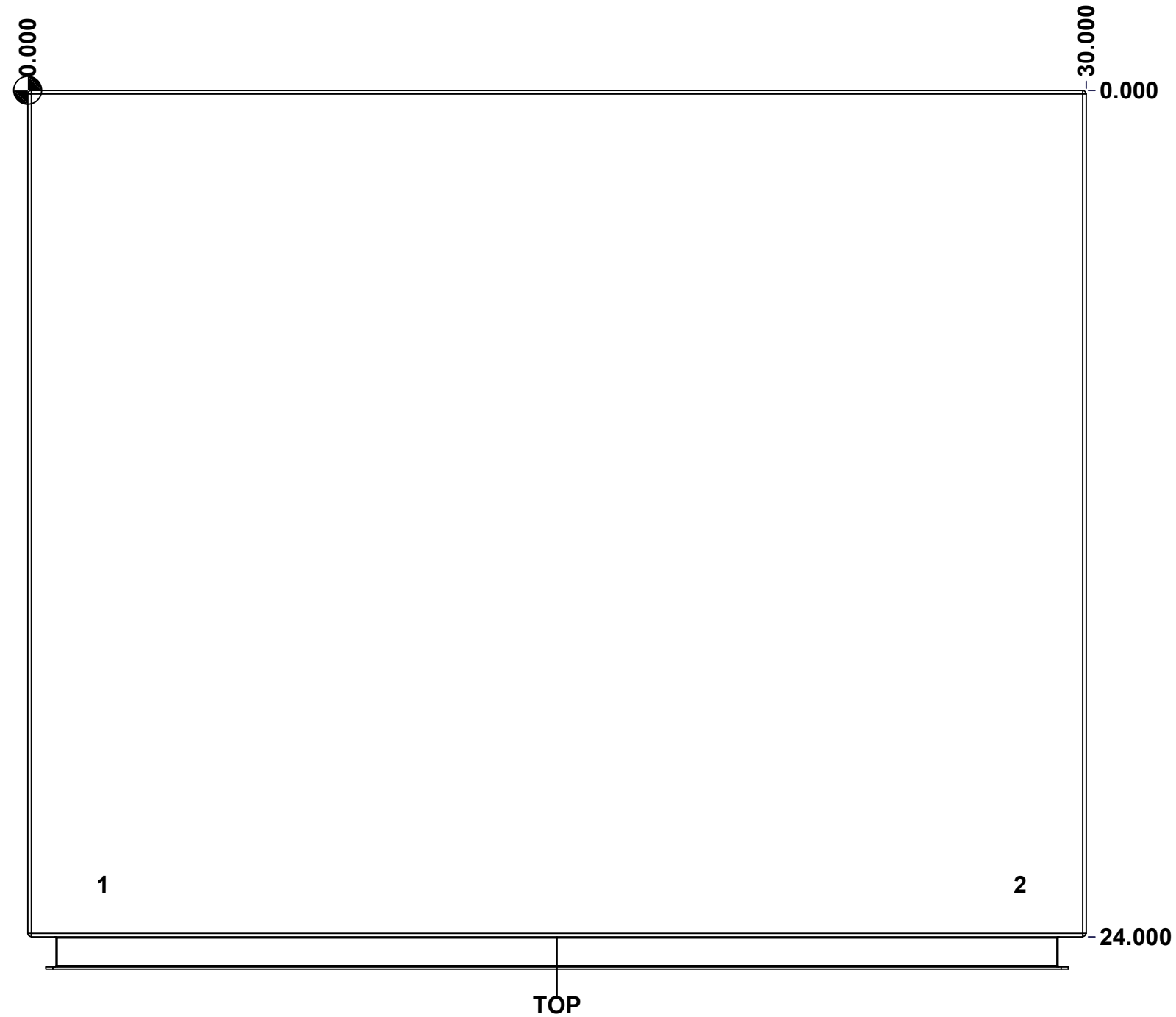

	Description	Status	
	5412ESSW 72" x 30" x 24" Body	(NULL)	
	Part Number Numéro Pièce	Rev.	
	5412ESSW723024THB	0	4 15

This drawing is confidential and must not be reproduced or used without the consent of EXM

Ce dessin est confidentiel et ne doit pas être reproduit ou utilisé sans le consentement de EXM

STANDARD FEATURES ARE NOT LISTED IN THIS HOLE TABLE			
HOLE TABLE - BOTTOM VIEW (CUSTOM FEATURE ONLY)			
CUT-OUT	XDIM	YDIM	DESCRIPTION
1	2.000	22.500	INSUL. STUD M6 x 18mm (Inside)
2	28.000	22.500	INSUL. STUD M6 x 18mm (Inside)

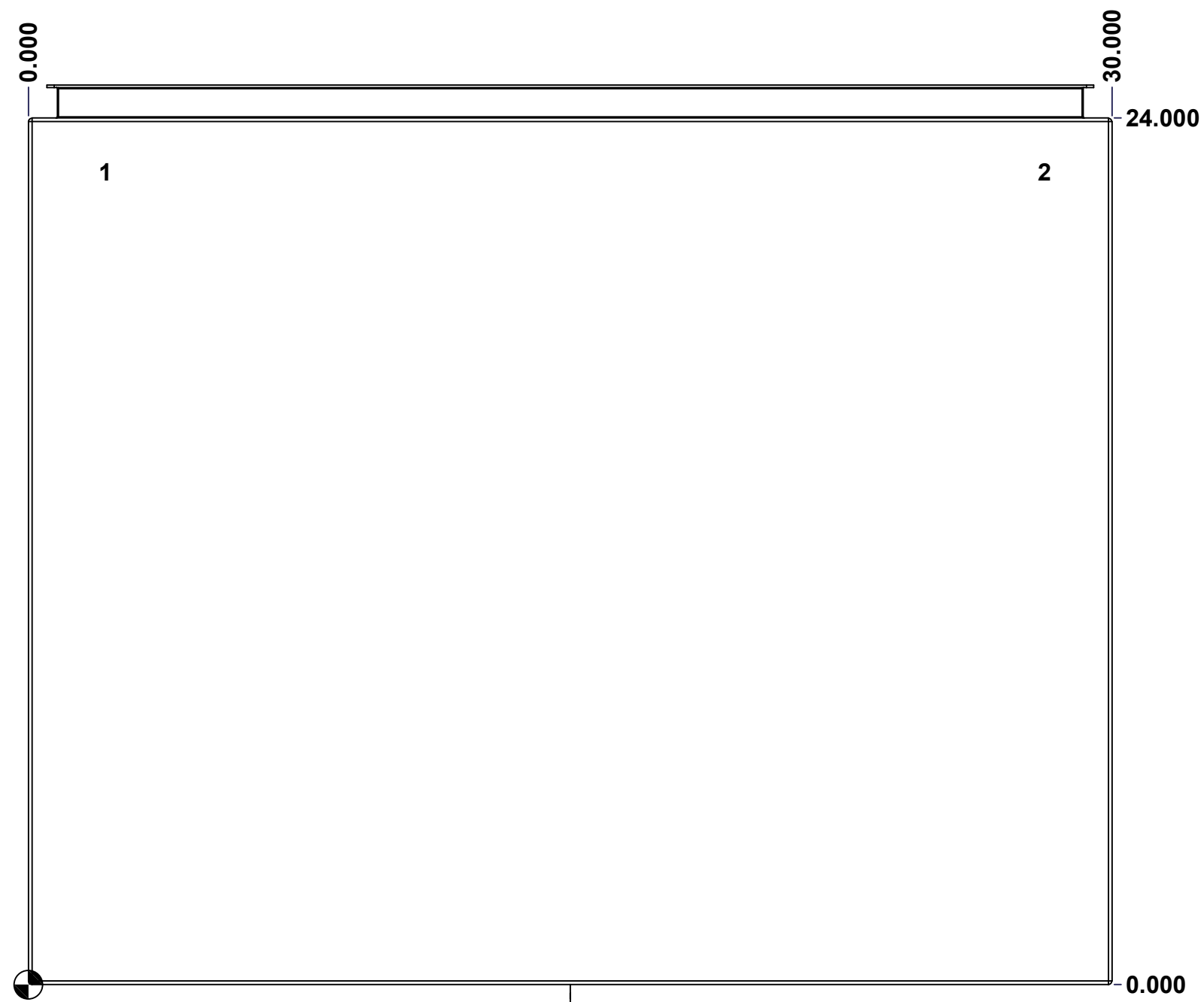

BOTTOM

	Description	Status	
	5412ESSW 72" x 30" x 24" Body	(NULL)	
	Part Number Numéro Pièce	Rev.	5
	5412ESSW723024THB	0	15

This drawing is confidential and must not be reproduced or used without the consent of EXM

Ce dessin est confidentiel et ne doit pas être reproduit ou utilisé sans le consentement de EXM

STANDARD FEATURES ARE NOT LISTED IN THIS HOLE TABLE

HOLE TABLE - BACK VIEW (CUSTOM FEATURE ONLY)

CUT-OUT	XDIM	YDIM	DESCRIPTION
1	1.875	1.875	IP STUD M8 x 35mm (Inside)
2	1.875	70.125	IP STUD M8 x 35mm (Inside)
3	28.125	70.125	IP STUD M8 x 35mm (Inside)
4	28.125	1.875	IP STUD M8 x 35mm (Inside)
5	1.875	36.000	IP STUD M8 x 35mm (Inside)
6	28.125	36.000	IP STUD M8 x 35mm (Inside)

7	29.250	0.000	FOOT 885 ESMF4_OPEN
8	0.750	0.000	FOOT 885 ESMF4_OPEN
9	29.250	72.000	FOOT 885 ESMF4_CLOSE
10	0.750	72.000	FOOT 885 ESMF4_CLOSE

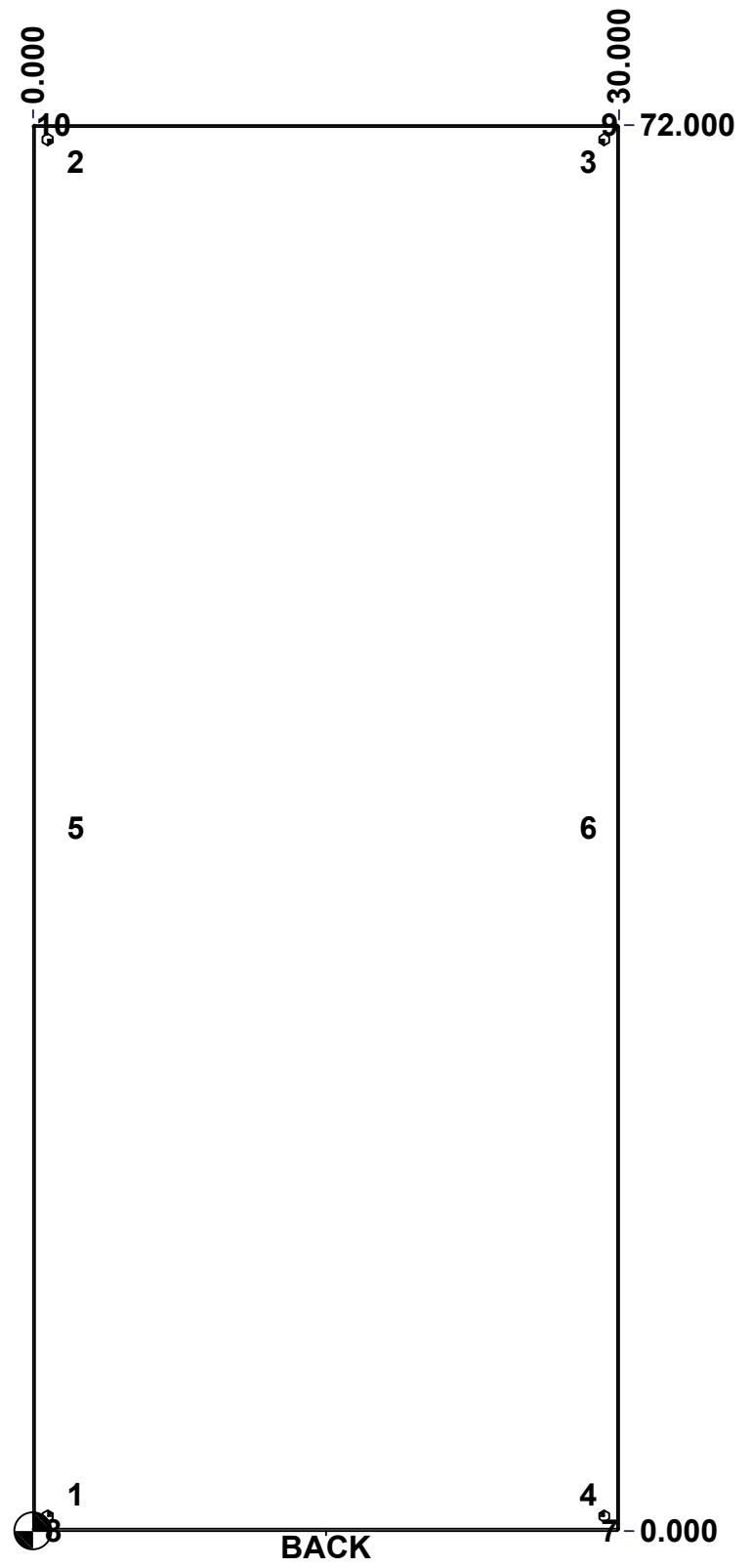

	Description	Status
	5412ESSW 72" x 30" x 24" Body	(NULL)
	Part Number Numéro Pièce	Rev.
	5412ESSW723024THB	0 / 6
		15

This drawing is confidential and must not be reproduced or used without the consent of EXM

Ce dessin est confidentiel et ne doit pas être reproduit ou utilisé sans le consentement de EXM

No.	Revisions	Date	By/Par

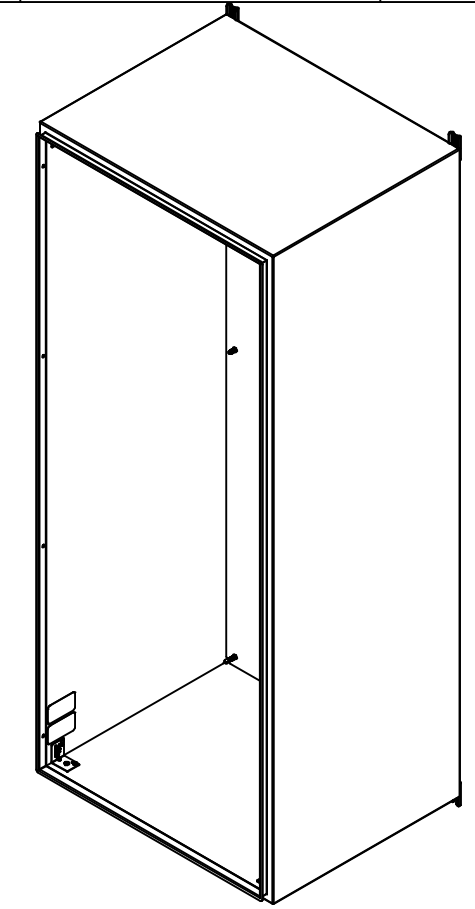

Isometric View



2	885ESMF4-FEET	0	885 ESMF4 Stainless Steel Mounting Foot
4	RIVET_NUT_SS_M10_FH_CE	0	Stainless Steel Rivet Nut M10 (Low Profile Close End)
4	STK-Q-06670	2	M10 x 16mm Stainless Steel Machine Screw
2	885ESMF4-FEET-A	0	885 ESMF4 Stainless Steel Mounting Foot (Opened Slot)
2	STK-S-00100	0	3.5" x 2" Silver Milar Flexcon Sticker
1	STK-K-70554	3	5412 ESTH Accessory Kit
1	5412ESSW723024THI-RS	0	5412ESSW 72" x 30" Right Insulation
1	5412ESSW723024THI-LS	0	5412ESSW 72" x 30" Left Insulation
1	5412ESSW723024THI-BT	0	5412ESSW 72" x 30" Top and Bottom Insulation
1	5412ESSW723024THI-TP	0	5412ESSW 72" x 30" Top and Bottom Insulation
1	5412ESSW723024THI-B	0	5412ESSW 72" x 30" Back Insulation
4	STK-Q-16070	1	Stud M6 x 18mm Stainless steel
6	STK-Q-16020	1	Stud M8 x 35mm Stainless Steel
1	5412ESSW723024THB-P	0	5412ESSW 72" x 30" x 24" Body Part

Qty	Part Number	Rev	Description
Parts List			

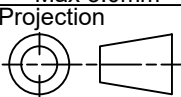
 Tél: (450) 979-4373 Fax: (450) 979-4626 www.exmweb.com		Flatness Aplatissement Max 3.0mm Projection 
Customer Client	Date	
Drawn By Dessiné Par	BoxCad: BoxCad	Date 05-Jun-23
Material Matière	14 Ga Stainless Steel 304 (1.7mm)	
Color Couleur	Unpainted	Finish Fini Brushed
Description		Detail Rev.
5412ESSW 72" x 30" x 24" Body		
Part Number Numéro Pièce	Rev.	7
5412ESSW723024THB	0	15

This drawing is confidential and must not be reproduced or used without the consent of EXM

Ce dessin est confidentiel et ne doit pas être reproduit ou utilisé sans le consentement de EXM

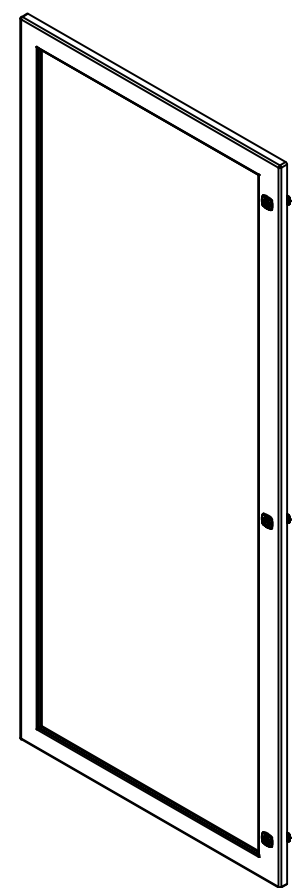
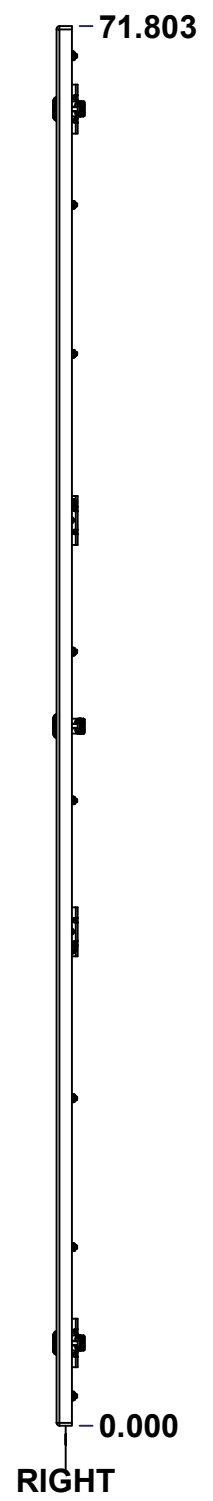
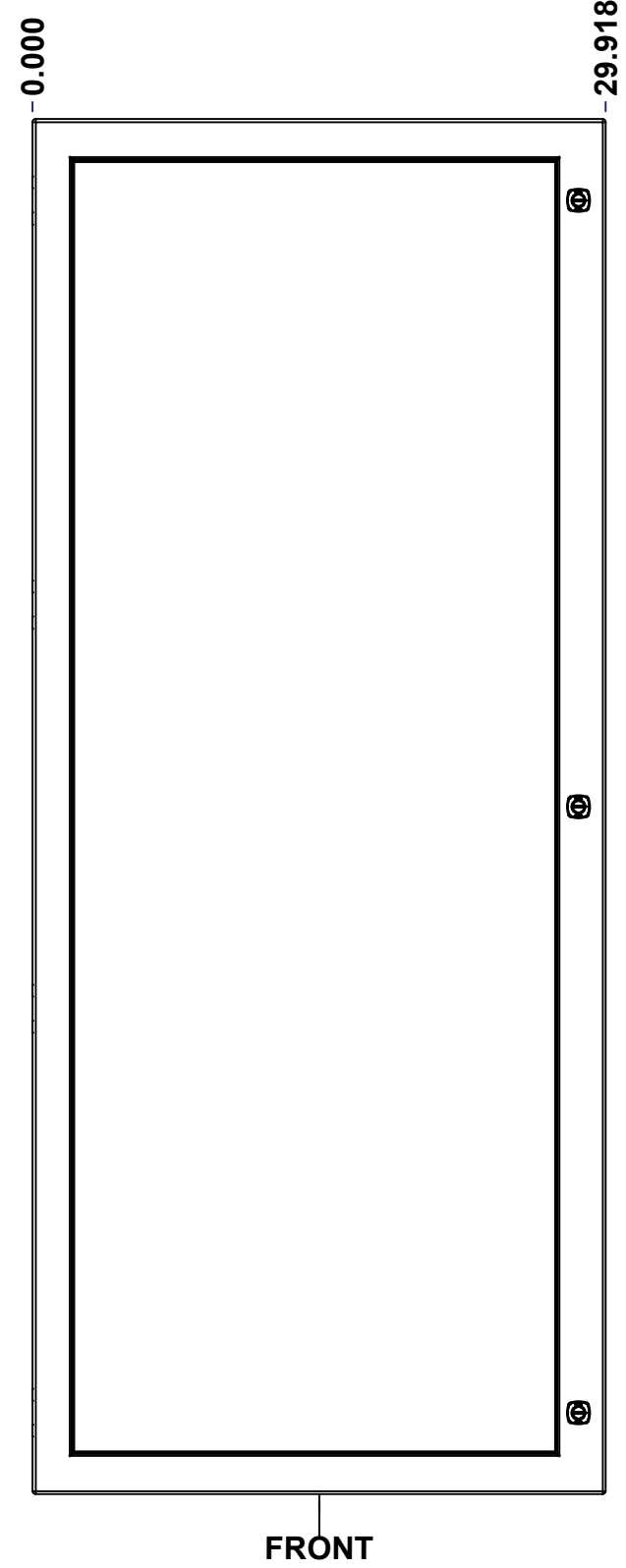
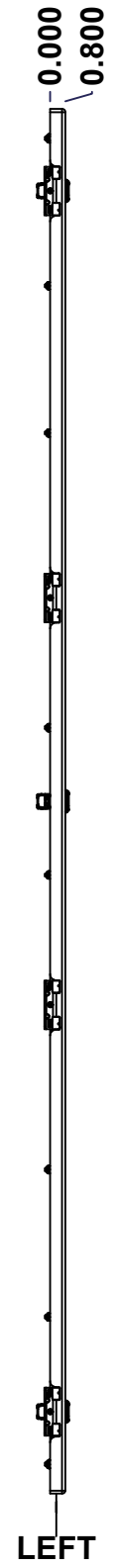
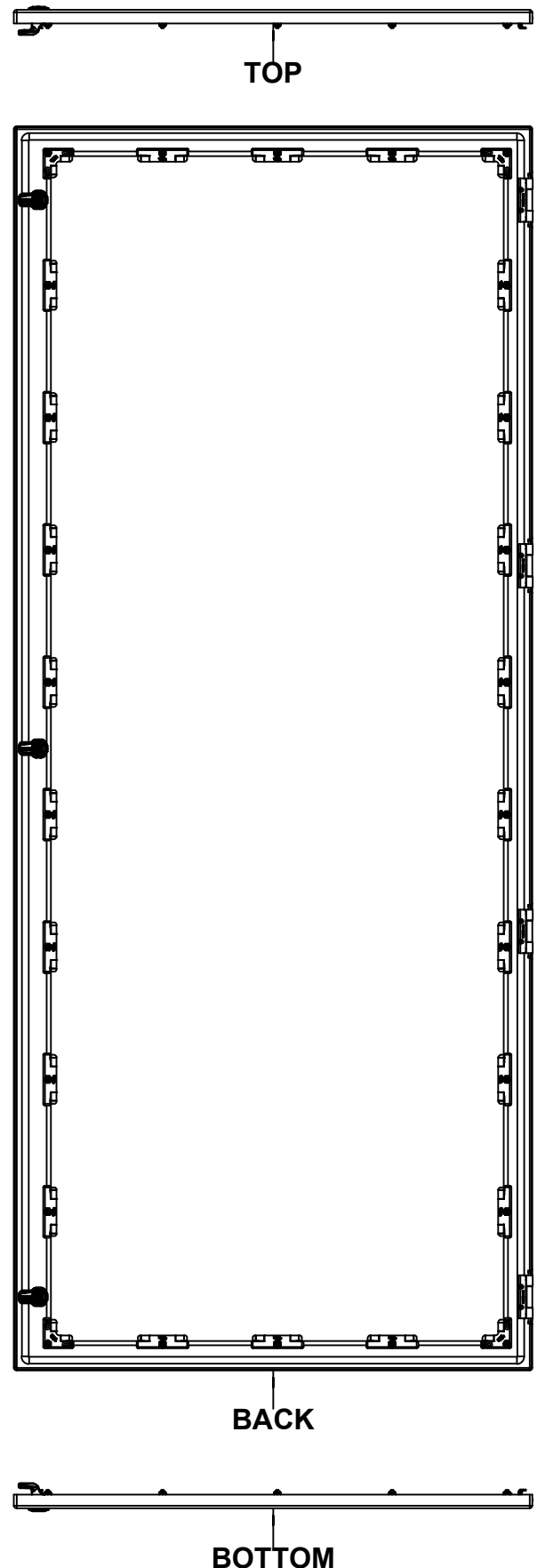

Isometric View

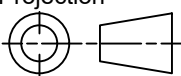

No.	Revisions	Date	By/Par

 Tél: (450) 979-4373 Fax: (450) 979-4626 www.exmweb.com		Flatness Aplatissement Max 3.0mm Projection 
Customer Client	Date	
Drawn By Dessiné Par	BoxCad: BoxCad	Date 05-Jun-23
Material Matière	14 Ga Stainless Steel 304 (1.7mm)	
Color Couleur	Unpainted	Finish Fini Brushed
Description 5412ESSW 72" x 30" Cover		Detail Rev.
Part Number Numéro Pièce	Rev. 0	8 / 15

SEE BILL OF MATERIAL ON LAST PAGE

5412ESSW723024THC

This drawing is confidential and must not be reproduced or used without the consent of EXM

Ce dessin est confidentiel et ne doit pas être reproduit ou utilisé sans le consentement de EXM

STANDARD FEATURES ARE NOT LISTED IN THIS HOLE TABLE			
HOLE TABLE - FRONT VIEW (CUSTOM FEATURE ONLY)			
CUT-OUT	XDIM	YDIM	DESCRIPTION
1	1.469	9.166	STUD M6 x 18mm (Inside)
2	27.968	9.166	STUD M6 x 18mm (Inside)
3	1.469	16.805	STUD M6 x 18mm (Inside)
4	27.968	16.805	STUD M6 x 18mm (Inside)
5	1.469	24.443	STUD M6 x 18mm (Inside)
6	27.968	24.443	STUD M6 x 18mm (Inside)
7	1.469	32.082	STUD M6 x 18mm (Inside)
8	27.968	32.082	STUD M6 x 18mm (Inside)
9	1.469	39.721	STUD M6 x 18mm (Inside)
10	27.968	39.721	STUD M6 x 18mm (Inside)
11	1.469	47.360	STUD M6 x 18mm (Inside)
12	27.968	47.360	STUD M6 x 18mm (Inside)
13	1.469	54.998	STUD M6 x 18mm (Inside)
14	27.968	54.998	STUD M6 x 18mm (Inside)
15	1.469	62.637	STUD M6 x 18mm (Inside)
16	27.968	62.637	STUD M6 x 18mm (Inside)
17	1.469	70.276	STUD M6 x 18mm (Inside)
18	1.469	1.527	STUD M6 x 18mm (Inside)
19	8.094	70.276	STUD M6 x 18mm (Inside)
20	8.094	1.527	STUD M6 x 18mm (Inside)
21	14.719	70.276	STUD M6 x 18mm (Inside)
22	14.719	1.527	STUD M6 x 18mm (Inside)
23	21.343	70.276	STUD M6 x 18mm (Inside)
24	21.343	1.527	STUD M6 x 18mm (Inside)
25	27.968	70.276	STUD M6 x 18mm (Inside)
26	27.968	1.527	STUD M6 x 18mm (Inside)

27	28.494	67.553	880 SCQ4-SLSS6
28	28.494	35.902	880 SCQ4-SLSS6
29	28.494	4.250	880 SCQ4-SLSS6

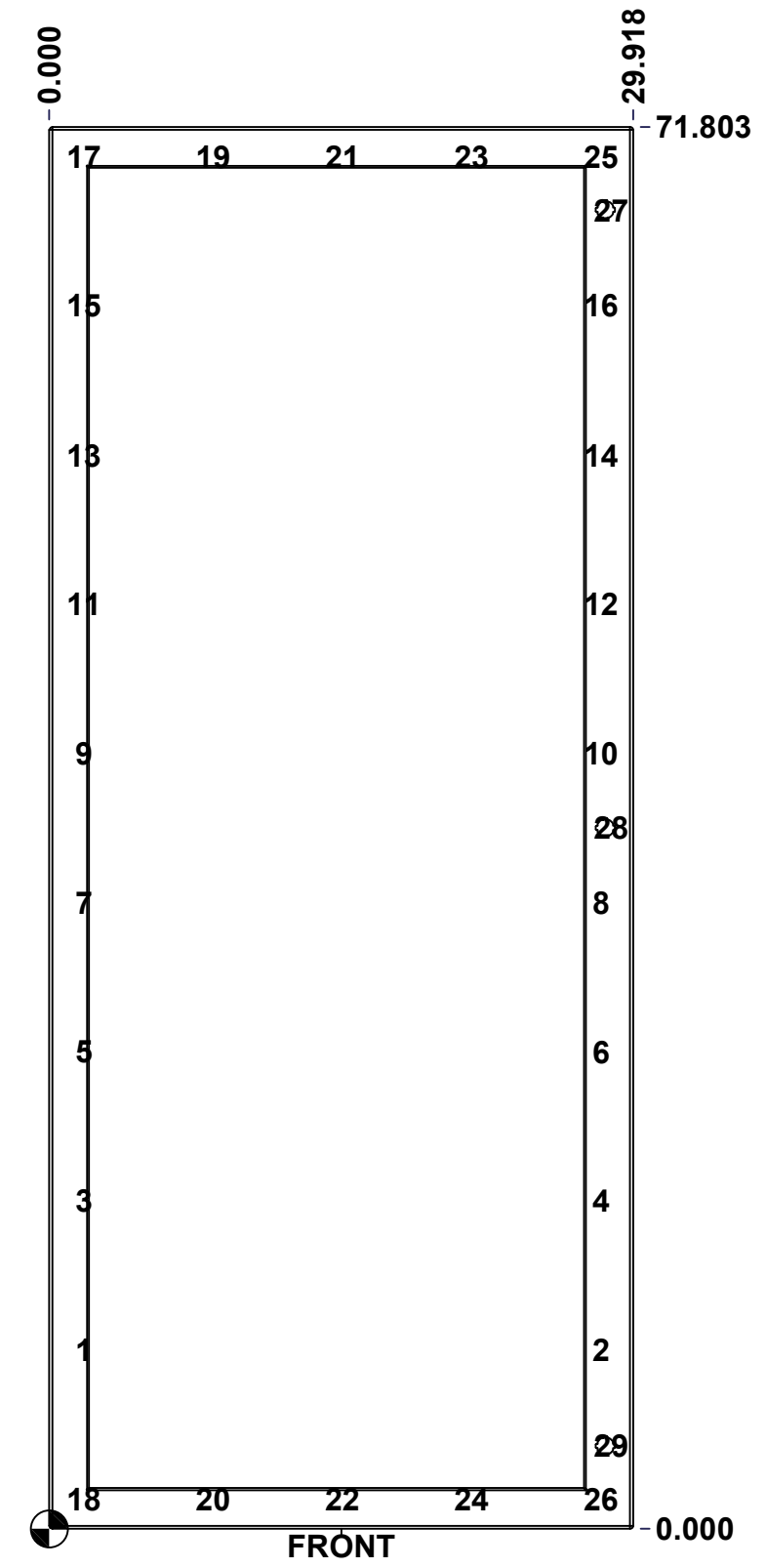

	Description		Status
	5412ESSW 72" x 30" Cover		(NULL)
Part Number		Rev.	9
Numéro Pièce		0	15
5412ESSW723024THC			

This drawing is confidential and must not be reproduced or used without the consent of EXM

Ce dessin est confidentiel et ne doit pas être reproduit ou utilisé sans le consentement de EXM

No.	Revisions	Date	By/Par

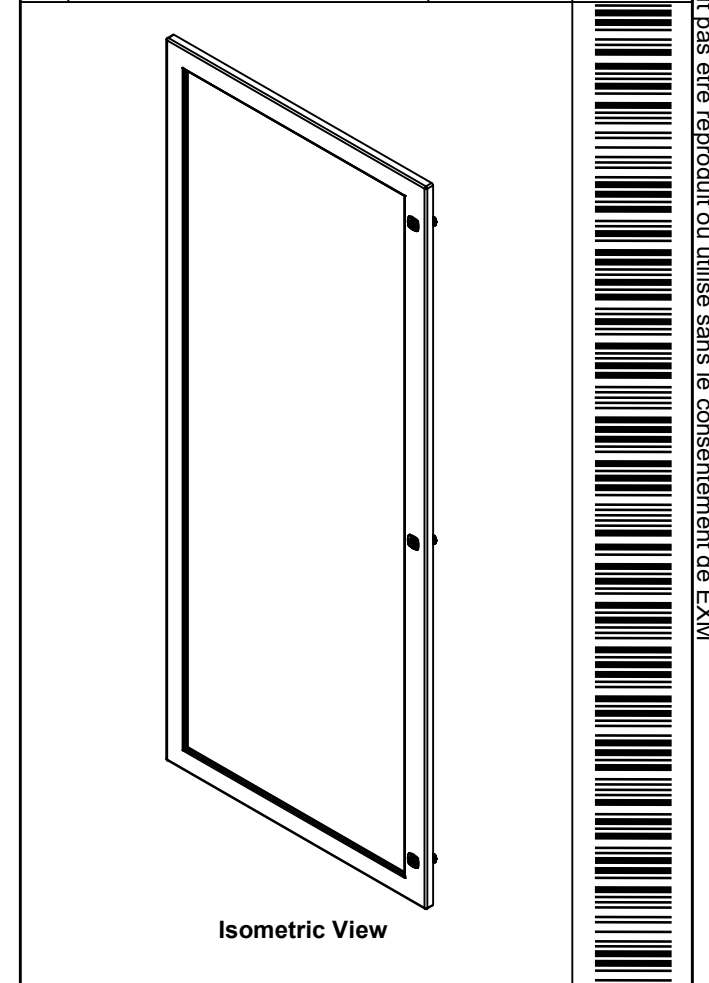

EXM
www.exmweb.com

Tél: (450) 979-4373
Fax: (450) 979-4626

Flatness
Aplatissement
Max 3.0mm

Projection

22	STK-Q-60701	2.1	880 WK - Lexan 1/4" Fixing Bracket
1	STK-A-60703	0	5412 ESW Lexan Bracket Kit
26	STK-Q-16053	1	Stud M6 x 23mm Stainless steel
1	STK-G-02710	0	880 HWKG - Windows Kit Gasket
1	5412ESSW723024THLXG	0	5412ESSW 72" x 30" Lexan Gasket Part
1	5412ESSW723024THLX	0	5412ESSW 68.375" x 26.125" Lexan Part
1	5412ESSW723024THG	0	5412ESSW 72" x 30" Cover Gasket Part
1	5412ESSW723024THC-P	0	5412ESSW 72" x 30" Cover Part
3	880 SCQ4-SLSS6	7	5412 ESS 1/4 Turn Lock
4	STK-A-33016	0	5412 ESS Bended Hinge (Body Part)

Customer Client	Date
Drawn By Dessiné Par	Date 05-Jun-23
Material Matière	14 Ga Stainless Steel 304 (1.7mm)
Color Couleur	Unpainted
Finish Fini	Brushed
Description	Detail Rev.
5412ESSW 72" x 30" Cover	
Part Number Numéro Pièce	Rev. 10
5412ESSW723024THC	0 15

QTY	Part Number	Rev	Description
Parts List			

This drawing is confidential and must not be reproduced or used without the consent of EXM

Ce dessin est confidentiel et ne doit pas être reproduit ou utilisé sans le consentement de EXM

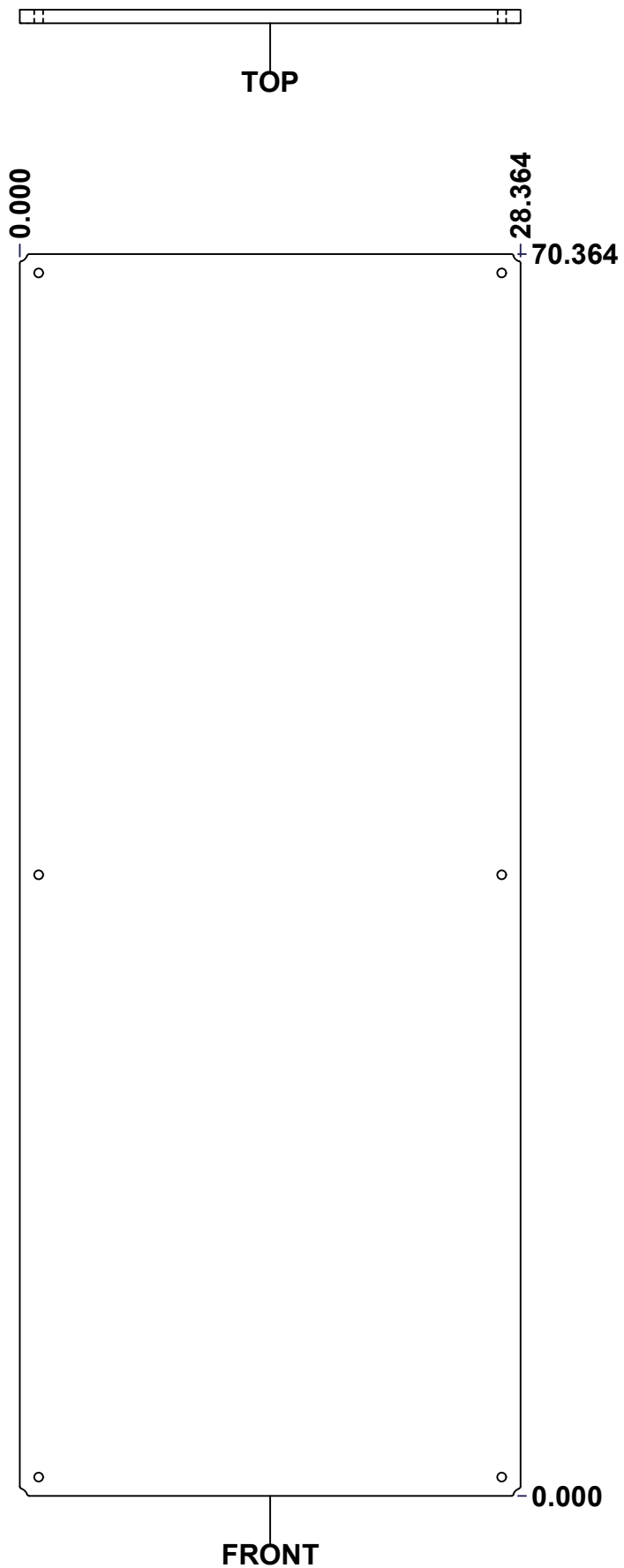

No.	Revisions	Date	By/Par

Isometric View

Tél: (450) 979-4373 Fax: (450) 979-4626 www.exmweb.com		Flatness Aplatissement Max 3.0mm
Projection		
Customer Client	Date	
Drawn By Dessiné Par	BoxCad: Patrick Deschenes	Date 23-Jan-07
Material Matière	Polyisocyanurate	
Color Couleur	Aluminum	Finish Fini N/A
Description		Detail Rev.
5412ESSW 72" x 30" Back Insulation		
Part Number Numéro Pièce	Rev.	11
5412ESSW723024TH-B	0	15

SEE BILL OF MATERIAL ON LAST PAGE

This drawing is confidential and must not be reproduced or used without the consent of EXM

Ce dessin est confidentiel et ne doit pas être reproduit ou utilisé sans le consentement de EXM

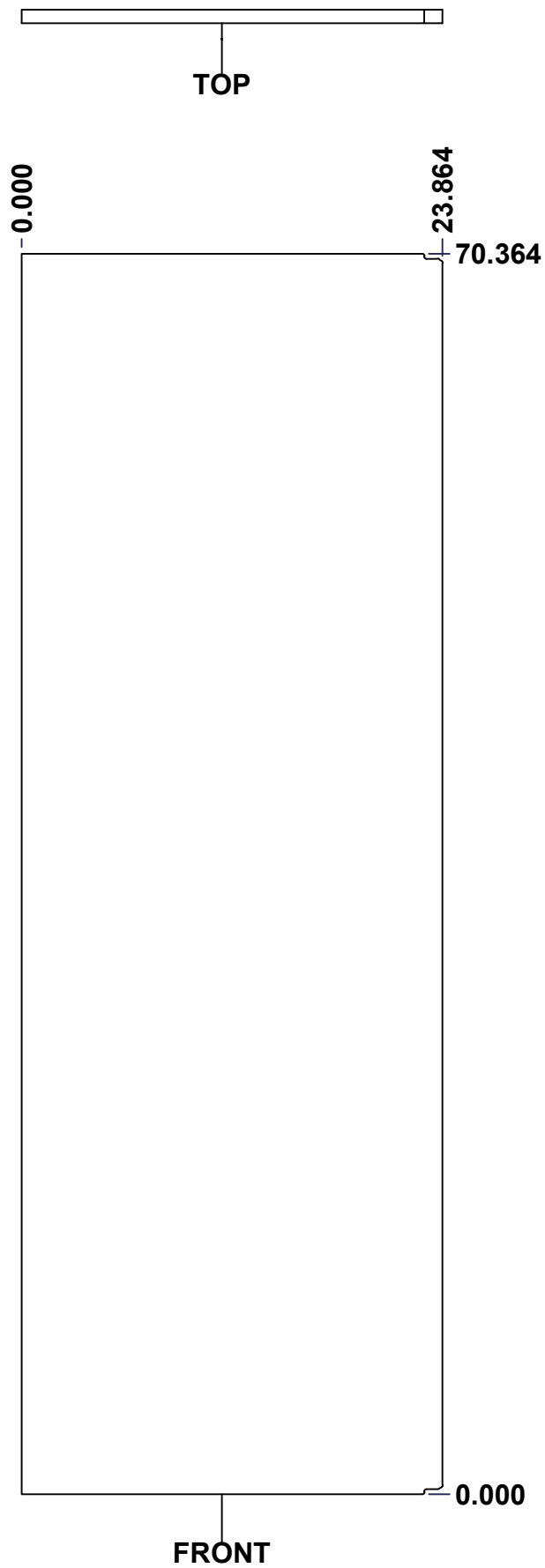

No.	Revisions	Date	By/Par

Isometric View

<p>Tél: (450) 979-4373 Fax: (450) 979-4626 www.exmweb.com</p>		Flatness Aplatissement	
		Max 3.0mm	
Customer Client		Date	
Drawn By Dessiné Par		Date	
Material Matière		Polyisocyanurate	
Color Couleur		Aluminum	Finish Fini
Description		Detail Rev.	
5412ESSW 72" x 30" Left Insulation			
Part Number Numéro Pièce		Rev.	
5412ESSW723024THI-LS		0	12 15

SEE BILL OF MATERIAL ON LAST PAGE

This drawing is confidential and must not be reproduced or used without the consent of EXM

Ce dessin est confidentiel et ne doit pas être reproduit ou utilisé sans le consentement de EXM

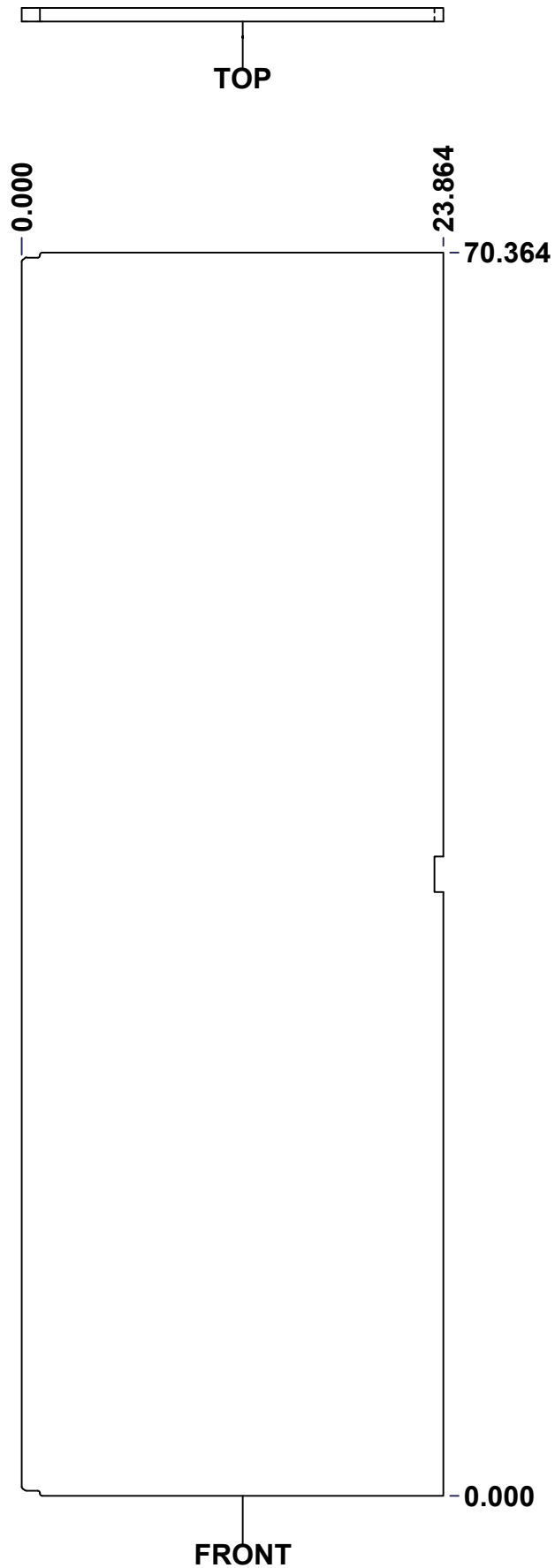

No.	Revisions	Date	By/Par

Isometric View

Tél: (450) 979-4373 Fax: (450) 979-4626 www.exmweb.com		Flatness Aplatissement Max 3.0mm
Projection 		Date 23-Jan-07
Customer Client	Date	
Drawn By Dessiné Par	BoxCad: Patrick Deschenes	Date 23-Jan-07
Material Matière	Polyisocyanurate	
Color Couleur	Aluminum	Finish Fini N/A
Description	Detail Rev.	
5412ESSW 72" x 30" Right Insulation		
Part Number Numéro Pièce	Rev.	13
5412ESSW723024THI-RS	0	15

SEE BILL OF MATERIAL ON LAST PAGE

This drawing is confidential and must not be reproduced or used without the consent of EXM

Ce dessin est confidentiel et ne doit pas être reproduit ou utilisé sans le consentement de EXM

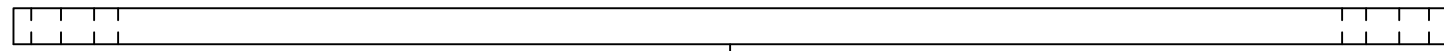

TOP

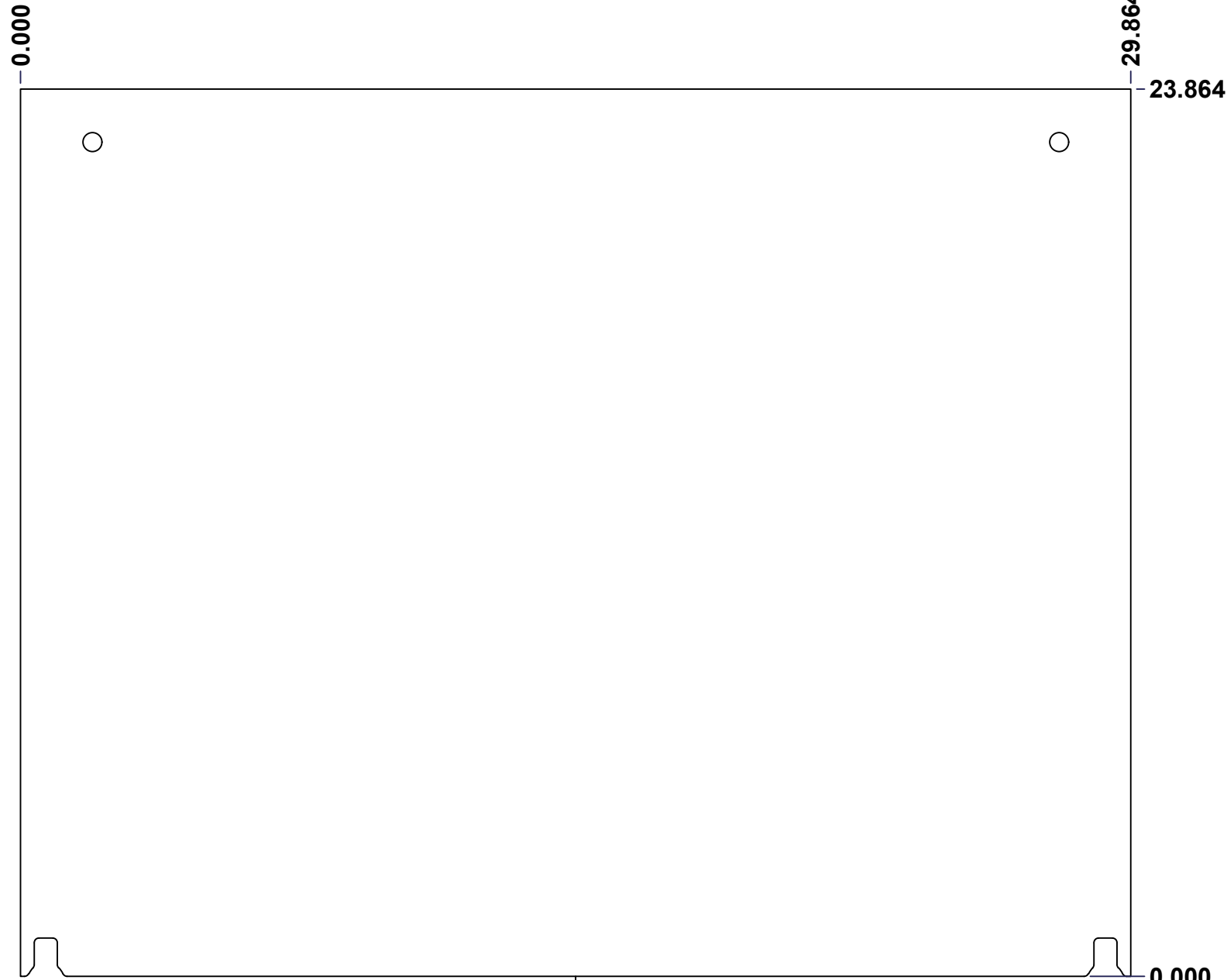

FRONT

0.000
0.750

RIGHT

No.	Revisions	Date	By/Par

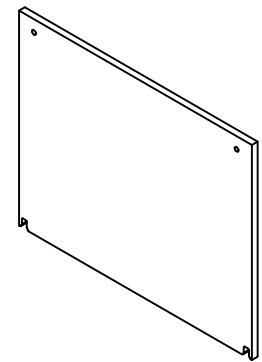

Isometric View



Tél: (450) 979-4373
Fax: (450) 979-4626
www.exmweb.com

Flatness
Aplatissement

Max 3.0mm

Projection

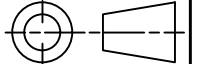

Customer Client	Date
Drawn By / Dessiné Par: BoxCad: Patrick Deschenes	Date: 23-Jan-07

Material / Matière: Polyisocyanurate

Color / Couleur: Aluminum	Finish / Fini: N/A
---------------------------	--------------------

Description: 5412ESSW 72" x 30" Top and Bottom Insulation	Detail Rev.
---	-------------

Part Number / Numéro Pièce: 5412ESSW723024THI-TP	Rev. 0	14	15
--	--------	----	----

SEE BILL OF MATERIAL ON LAST PAGE

This drawing is confidential and must not be reproduced or used without the consent of EXM

Ce dessin est confidentiel et ne doit pas être reproduit ou utilisé sans le consentement de EXM

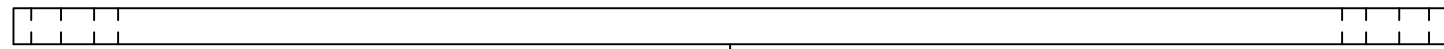

TOP

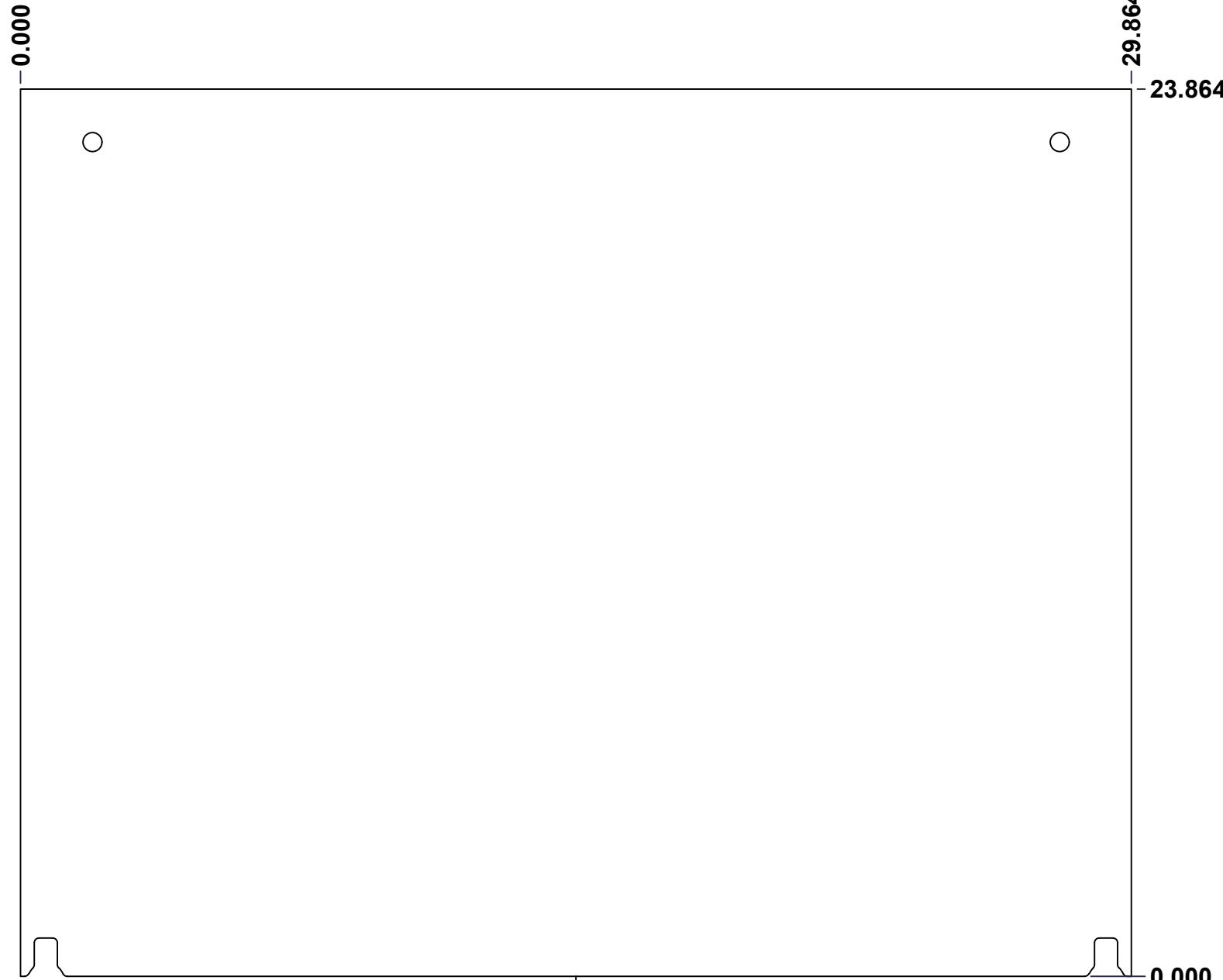

FRONT

0.000
0.750

RIGHT

No.	Revisions	Date	By/Par

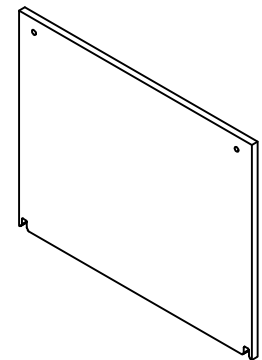

Isometric View



Tél: (450) 979-4373
Fax: (450) 979-4626
www.exmweb.com

Flatness
Aplatissement

Max 3.0mm

Projection

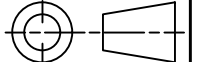

Customer Client	Date
Drawn By / Dessiné Par: BoxCad: Patrick Deschenes	Date: 23-Jan-07

Material / Matière: Polyisocyanurate

Color / Couleur: Aluminum	Finish / Fini: N/A
---------------------------	--------------------

Description: 5412ESSW 72" x 30" Top and Bottom Insulation	Detail Rev.
---	-------------

Part Number / Numéro Pièce: 5412ESSW723024THI-BT	Rev. 0	15 / 15
--	--------	---------

SEE BILL OF MATERIAL ON LAST PAGE

This drawing is confidential and must not be reproduced or used without the consent of EXM

Ce dessin est confidentiel et ne doit pas être reproduit ou utilisé sans le consentement de EXM

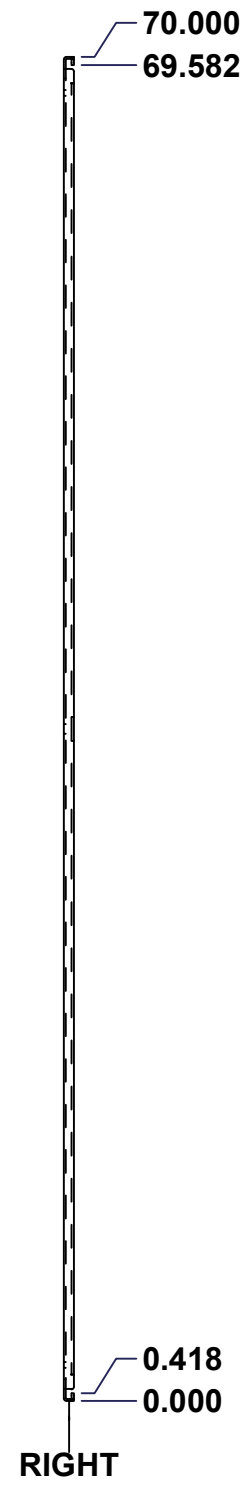
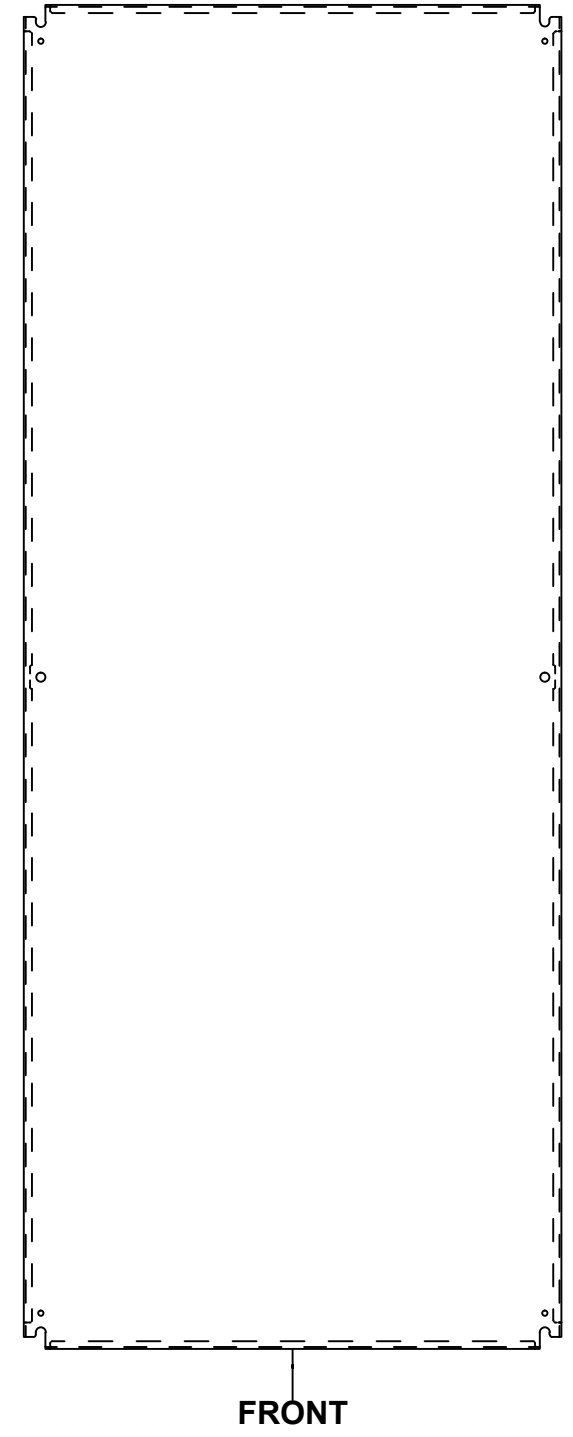
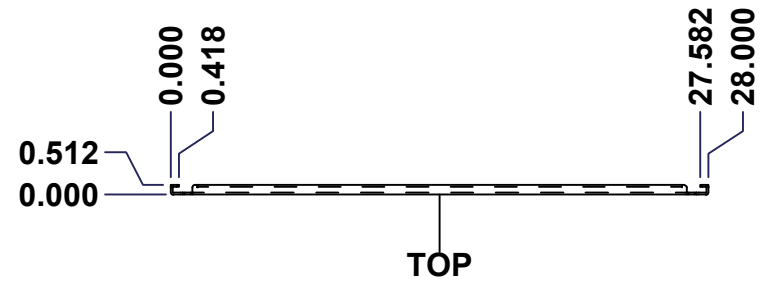

No.	Revisions	Date	By/Par

Isometric View

Tél: (450) 979-4373 Fax: (450) 979-4626 www.exmweb.com	Flatness Aplatissement Max 3.0mm
	Projection
Customer Client	Date
Drawn By / Dessiné Par: BoxCad	Date: 23-Jan-07
Material / Matière: See Part List	
Color / Couleur: See Part List	Finish / Fini: See Part List
Description: 881 SP - Inner Panel	Detail Rev.
Part Number / Numéro Pièce: 881 SP7230G	Rev. 1 0

Qty	Part Number	Rev	Description	Material	Color	Finish
1	881 SP7230G-P	0	881 SP - Inner Panel Part	12 Ga Galvanized	Unpainted	Galvanized

Parts List

This drawing is confidential and must not be reproduced or used without the consent of EXM

Ce dessin est confidentiel et ne doit pas être reproduit ou utilisé sans le consentement de EXM

Table 1			FRONT VIEW
CUT-OUT	XDIM	YDIM	DESCRIPTION
1	0.875	1.875	GROUND HOLE (RND Ø0.290)
2	27.125	1.875	GROUND HOLE (RND Ø0.290)
3	0.875	68.125	GROUND HOLE (RND Ø0.290)
4	27.125	68.125	GROUND HOLE (RND Ø0.290)
5	0.875	35.000	MTG STUD HOLE (RND Ø0.500)
6	27.125	35.000	MTG STUD HOLE (RND Ø0.500)

All knockouts are actual size / Les disques défonçables sont grandeur réel

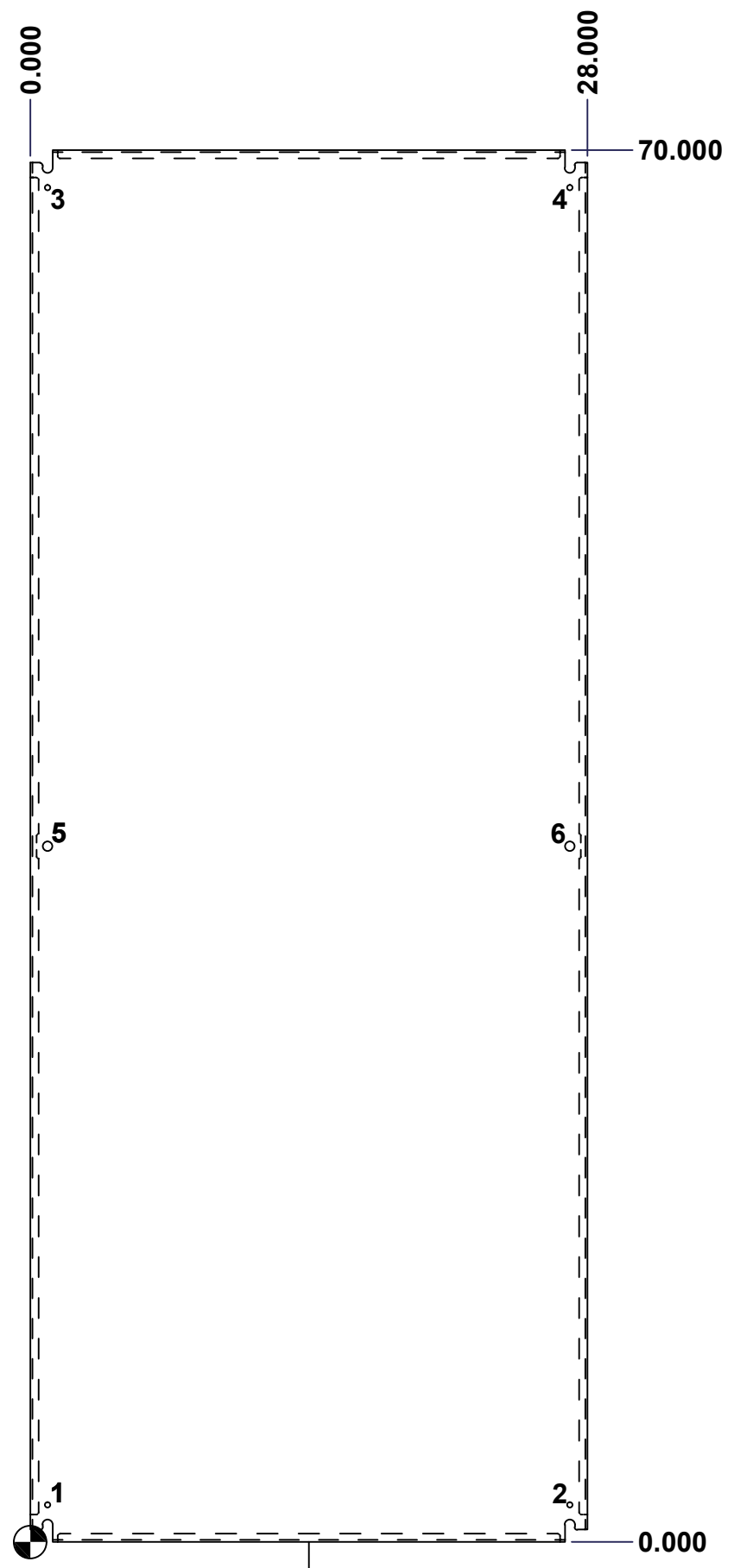

FRONT

No.	Revisions	Date	By/Par

Isometric View

		Tél: (450) 979-4373 Fax: (450) 979-4626 www.exmweb.com		Flatness Aplatissement Max 3.0mm	
Customer Client		Date		Projection 	
Drawn By Dessiné Par BoxCad		Date 23-Jan-07		Material Matière See Part List	
Color Couleur See Part List		Finish Fini See Part List		Description 881 SP - Inner Panel	
Part Number Numéro Pièce 881 SP7230G		Rev. 0		Detail Rev. 2	