

This drawing is confidential and must not be reproduced or used without the consent of EXM

Ce dessin est confidentiel et ne doit pas être reproduit ou utilisé sans le consentement de EXM

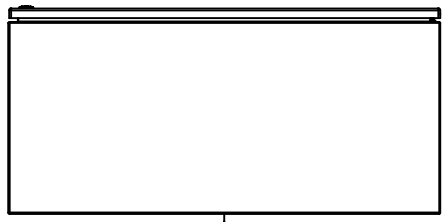

TOP

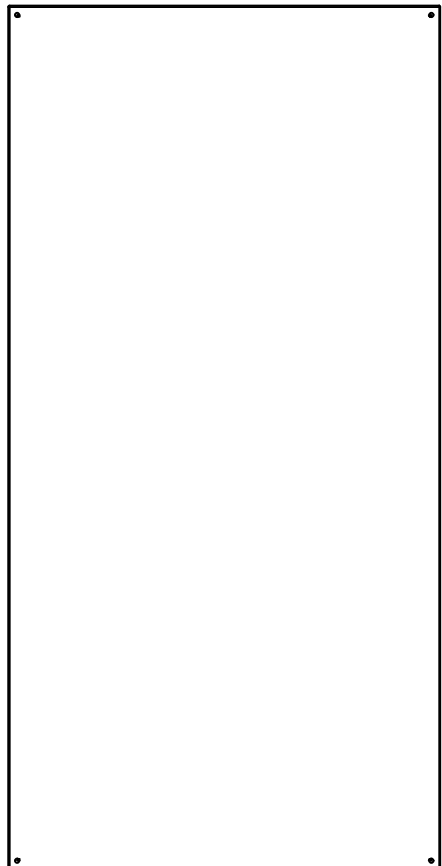

BACK

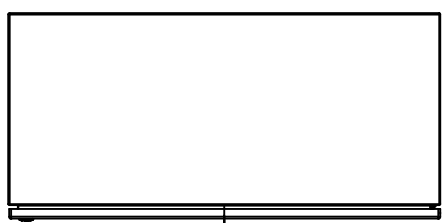

BOTTOM

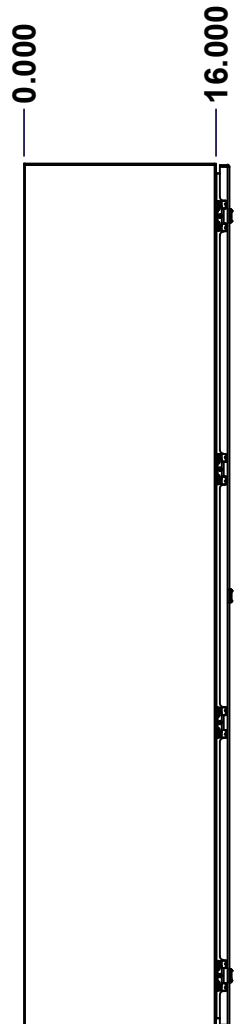

LEFT

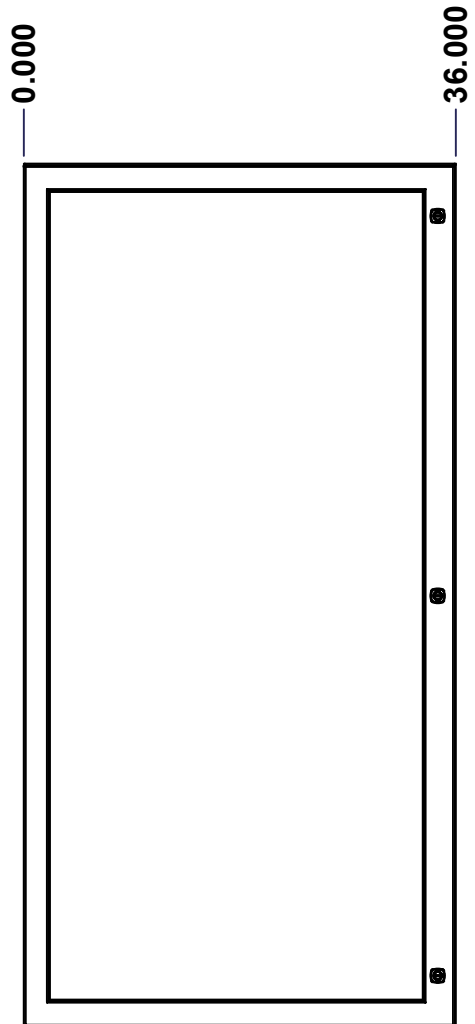

FRONT

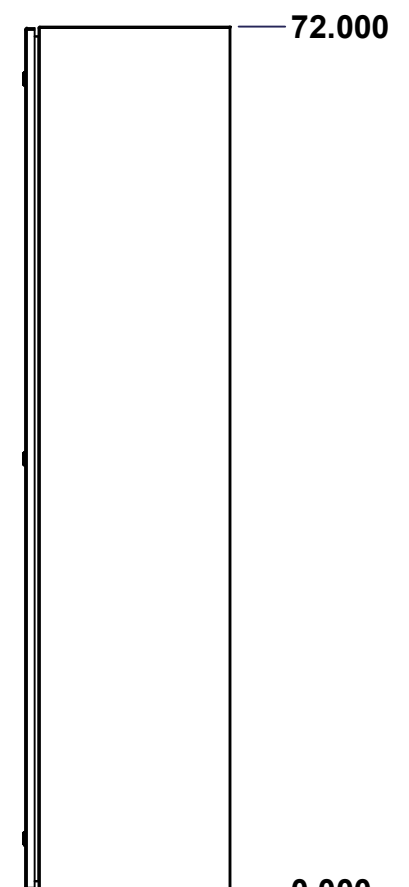

RIGHT

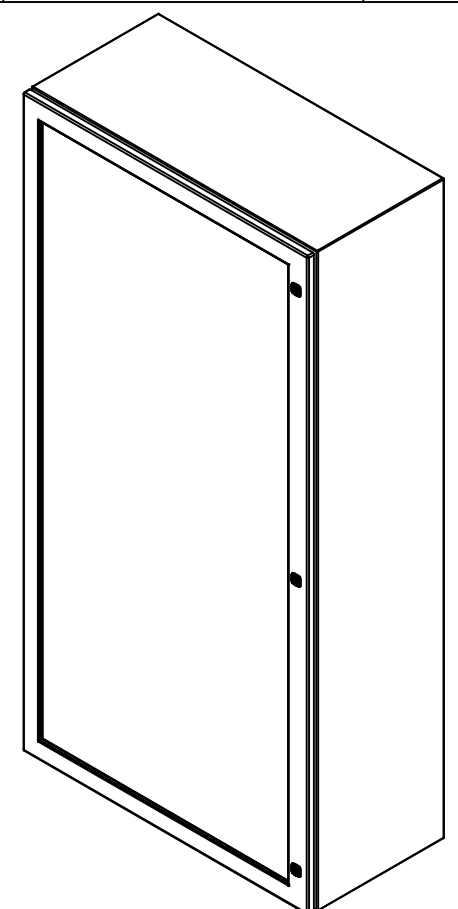

Isometric View



**GRAIN DIRECTION:
TOP/BOTTOM: HORIZONTAL
LEFT/RIGHT/BACK/FRONT: VERTICAL**

SEE BILL OF MATERIAL ON LAST PAGE

No.	Revisions	Date	By/Par

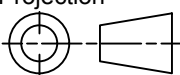
 Tél: (450) 979-4373 Fax: (450) 979-4626 www.exmweb.com		Flatness Aplatissement Max 3.0mm Projection 
Customer Client	Date	
Drawn By Dessiné Par	BoxCad: BoxCad	Date 21-Jun-23
Material Matière	14 Ga Stainless Steel 316 (1.7mm)	
Color Couleur	Unpainted	Finish Fini Brushed
Description	Detail Rev.	
5412ESSW 72" x 36" x 16" Assembly		
Part Number Numéro Pièce	Rev. 0	1 9
5412ESSW7236166NOIP		

This drawing is confidential and must not be reproduced or used without the consent of EXM

Ce dessin est confidentiel et ne doit pas être reproduit ou utilisé sans le consentement de EXM

NOTE	
ITEM	DESCRIPTION
1	NEMA 4X Enclosure
2	C/W Standard ground studs on box and cover
3	W/O Standard door stiffener
4	W/O Inner panel
5	C/W Standard inner panel mounting studs

No.	Revisions	Date	By/Par

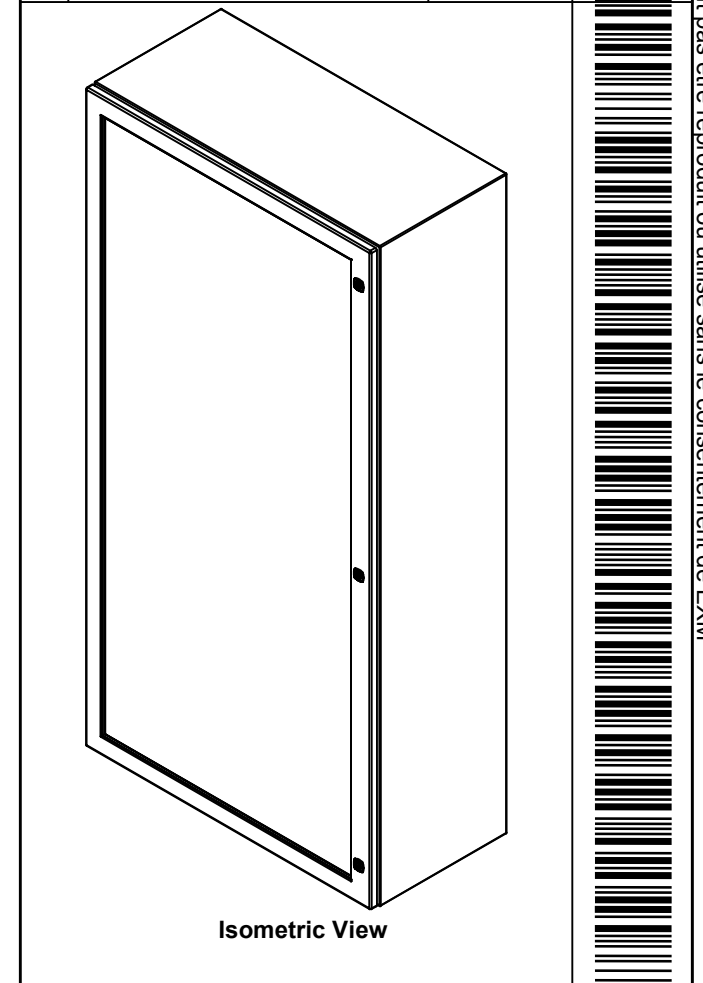

PACKING		
ITEM	QTY	DESCRIPTION
Cardboard sleeve	2	Top and Bottom
Cardboard strip	2	Between back of enclosure and inner panel
Plastic bag	1	To protect cover surface and inside gasket
Cardboard corner	4	To reinforced for the plastic strap tightening
Plastic strap - Black	2	To Squeeze the 2 cardboard sleeve together
Packaging label	3	White label with PN
Plastic strap- Green	2	To secure the enclosure to the wood pallet
Wood Pallet	1	2" deeper and 3" larger than enclosure size

1	STK-K-01800	5	5412 ES Accessory Kit
1	5412ESSW7236166NOIP C	0	5412ESSW 72" x 36" Cover
1	5412ESSW7236166NOIP B	0	5412ESSW 72" x 36" x 16" Body
4	STK-Q-04051-08	1	M6 x 8mm Stainless Steel Hexagon Socket Head Machine Screw with Nyseal
Qty	Part Number	Rev	Description
Parts List			

		Tél: (450) 979-4373 Fax: (450) 979-4626 www.exmweb.com		Flatness Aplatissement Max 3.0mm
Customer Client		Date		
Drawn By Dessiné Par BoxCad: BoxCad		Date 21-Jun-23		
Material Matière 14 Ga Stainless Steel 316 (1.7mm)		Color Couleur Unpainted		Finish Fini Brushed
Description 5412ESSW 72" x 36" x 16" Assembly			Detail Rev.	
Part Number Numéro Pièce 5412ESSW7236166NOIP			Rev. 0	2 9

This drawing is confidential and must not be reproduced or used without the consent of EXM

Ce dessin est confidentiel et ne doit pas être reproduit ou utilisé sans le consentement de EXM

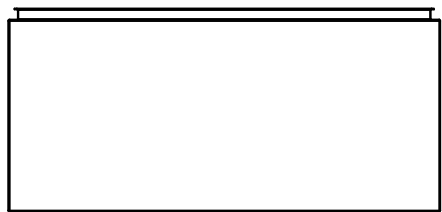

TOP

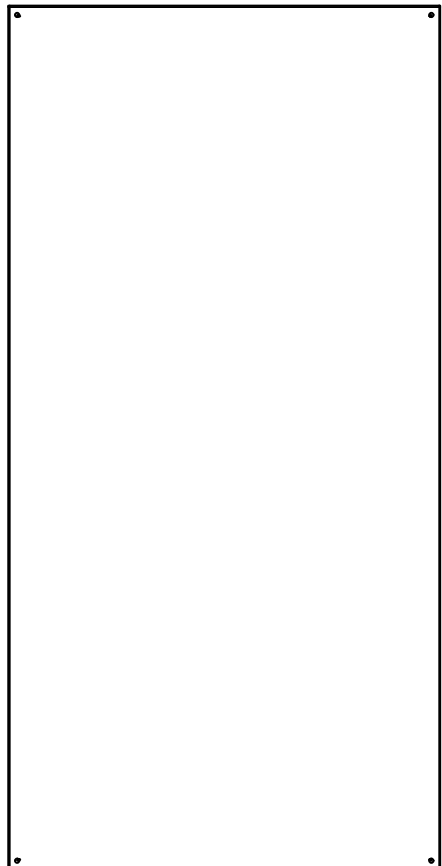

BACK

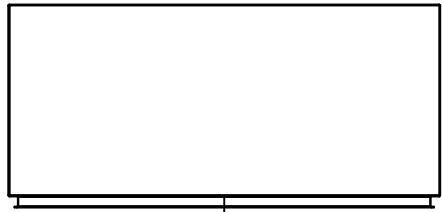

BOTTOM

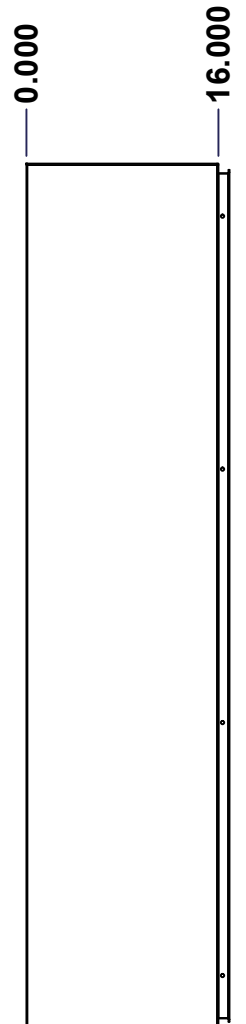

LEFT

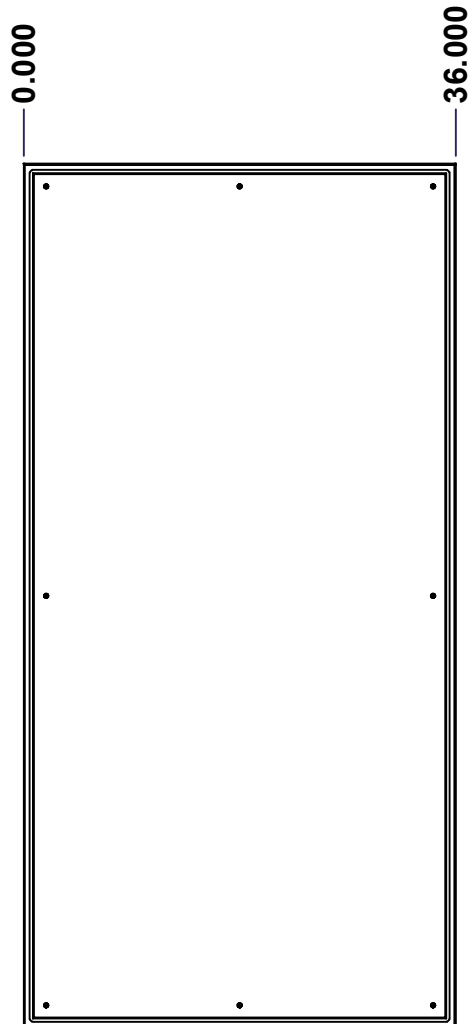

FRONT

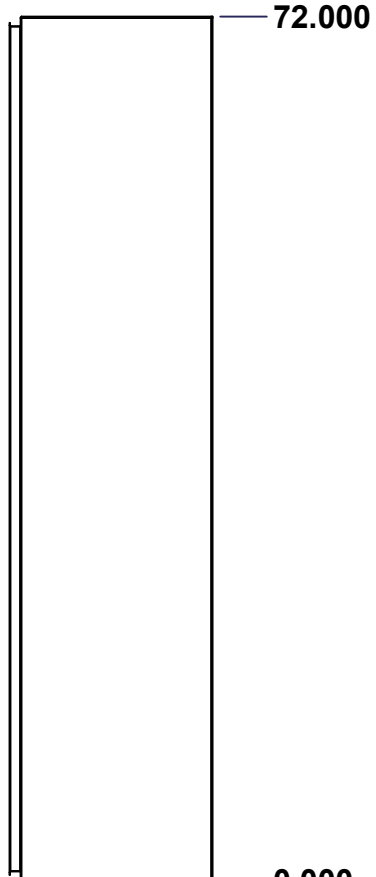

RIGHT

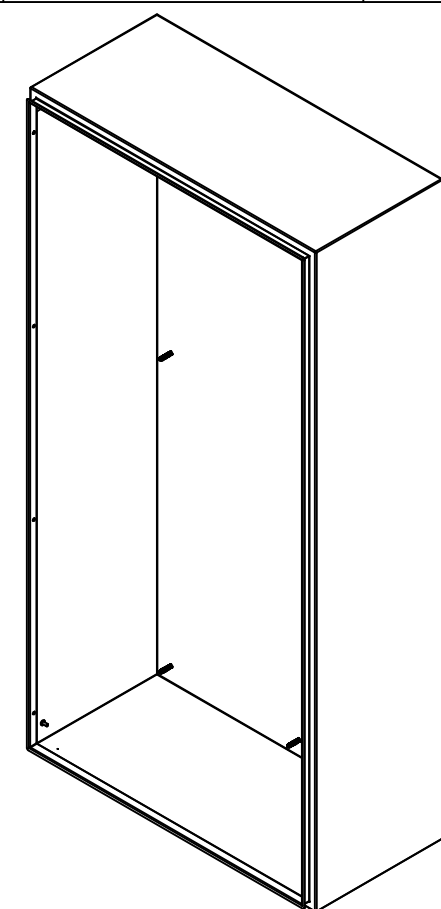

Isometric View

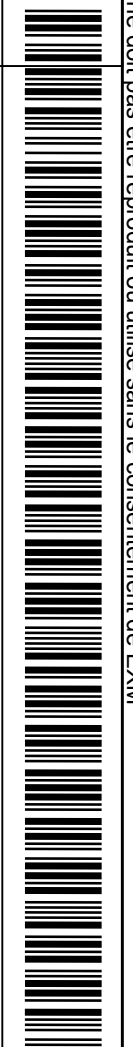

No.	Revisions	Date	By/Par

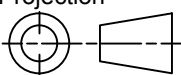
 Tél: (450) 979-4373 Fax: (450) 979-4626 www.exmweb.com		Flatness Aplatissement Max 3.0mm Projection 
Customer Client	Date	
Drawn By Dessiné Par	BoxCad: BoxCad	Date 21-Jun-23
Material Matière	14 Ga Stainless Steel 316 (1.7mm)	
Color Couleur	Unpainted	Finish Fini Brushed
Description	Detail Rev.	
5412ESSW 72" x 36" x 16" Body		
Part Number Numéro Pièce	Rev. 0	3 9

SEE BILL OF MATERIAL ON LAST PAGE **5412ESSW7236166NOIPB**

This drawing is confidential and must not be reproduced or used without the consent of EXM

Ce dessin est confidentiel et ne doit pas être reproduit ou utilisé sans le consentement de EXM

STANDARD FEATURES ARE NOT LISTED IN THIS HOLE TABLE			
HOLE TABLE - LEFT VIEW (CUSTOM FEATURE ONLY)			
CUT-OUT	XDIM	YDIM	DESCRIPTION
1	14.500	2.000	GND STUD M6 x 16mm (Inside)
2	14.000	70.000	LABEL_EXM (Inside)

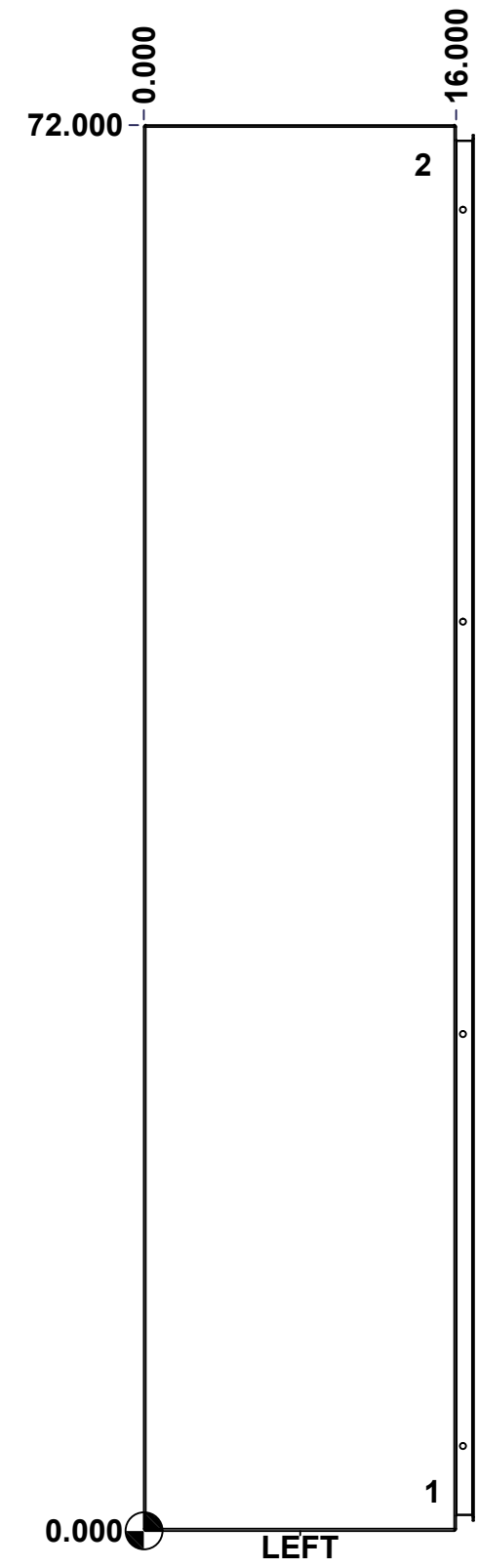

	Description	Status	
	5412ESSW 72" x 36" x 16" Body	(NULL)	
	Part Number Numéro Pièce	Rev.	
	5412ESSW7236166NOIPB	0	4 9

This drawing is confidential and must not be reproduced or used without the consent of EXM

Ce dessin est confidentiel et ne doit pas être reproduit ou utilisé sans le consentement de EXM

STANDARD FEATURES ARE NOT LISTED IN THIS HOLE TABLE

HOLE TABLE - BACK VIEW (CUSTOM FEATURE ONLY)

CUT-OUT	XDIM	YDIM	DESCRIPTION
1	1.875	1.875	IP STUD M8 x 35mm (Inside)
2	1.875	70.125	IP STUD M8 x 35mm (Inside)
3	34.125	70.125	IP STUD M8 x 35mm (Inside)
4	34.125	1.875	IP STUD M8 x 35mm (Inside)
5	1.875	36.000	IP STUD M8 x 35mm (Inside)
6	34.125	36.000	IP STUD M8 x 35mm (Inside)
7	18.000	1.875	IP STUD M8 x 35mm (Inside)
8	18.000	70.125	IP STUD M8 x 35mm (Inside)

9	35.250	0.750	RND Ø0.390
10	35.250	71.250	RND Ø0.390
11	0.750	71.250	RND Ø0.390
12	0.750	0.750	RND Ø0.390

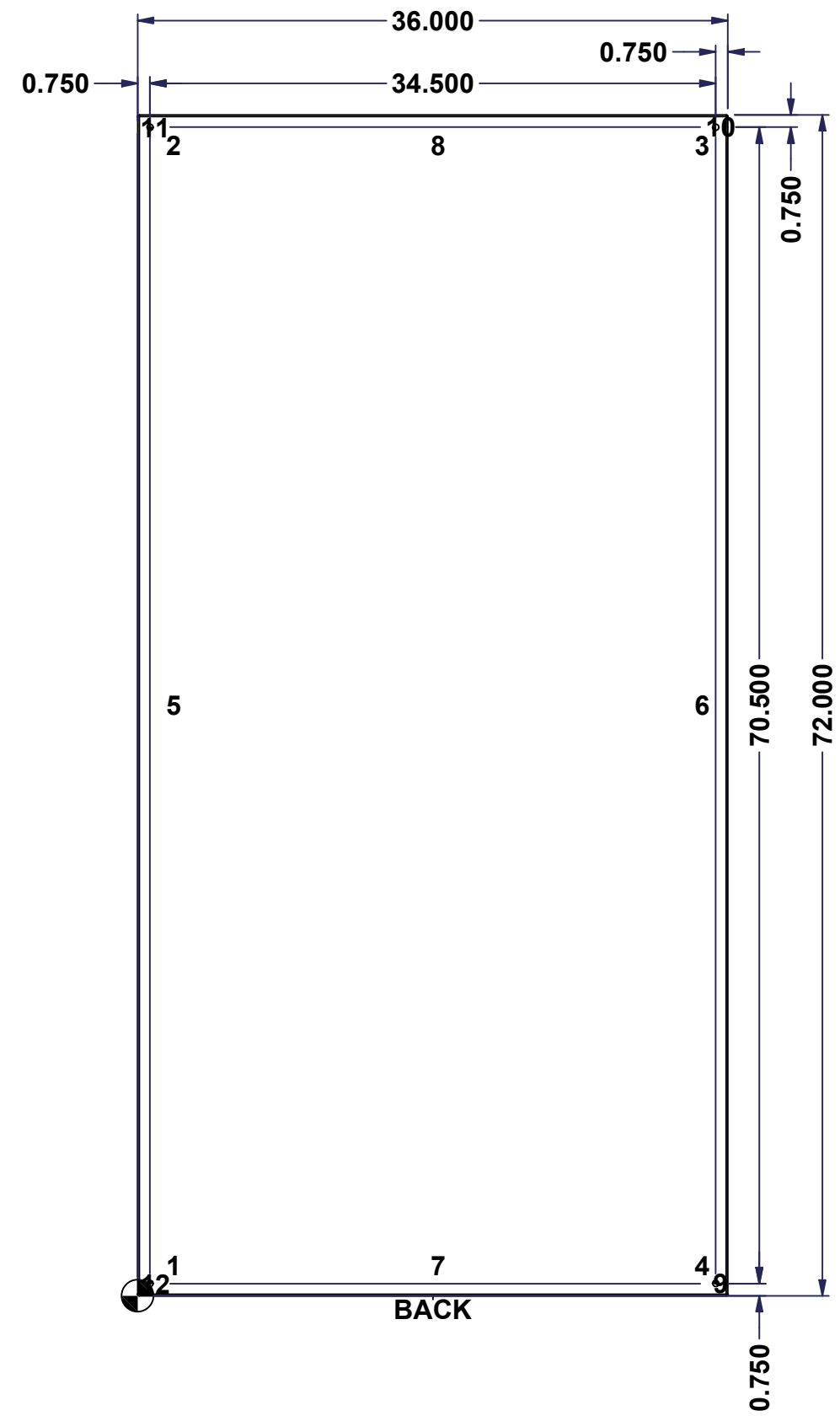

BACK

	Description	Status
	5412ESSW 72" x 36" x 16" Body	(NULL)
	Part Number Numéro Pièce	Rev.
	5412ESSW7236166NOIPB	0 / 5 / 9

This drawing is confidential and must not be reproduced or used without the consent of EXM

Ce dessin est confidentiel et ne doit pas être reproduit ou utilisé sans le consentement de EXM

No.	Revisions	Date	By/Par

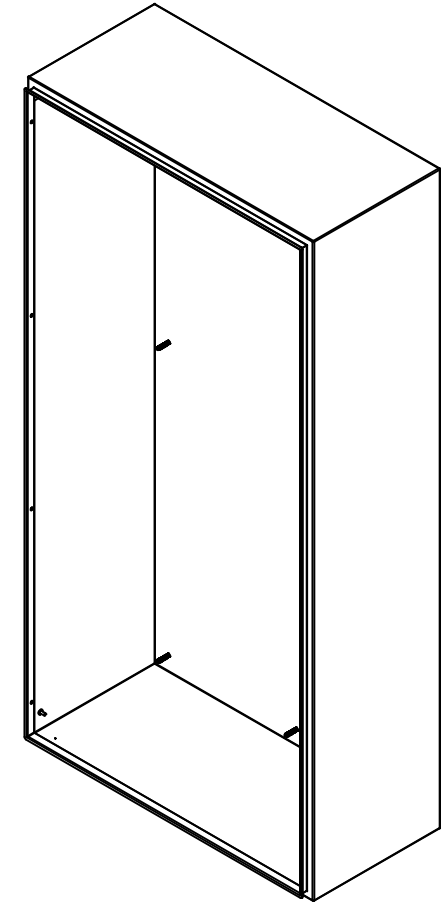

Isometric View

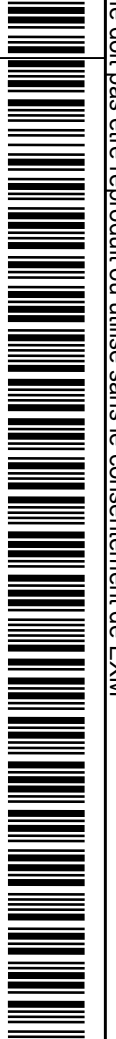

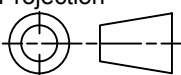
 Tél: (450) 979-4373 Fax: (450) 979-4626 www.exmweb.com	Flatness Aplatissement	Max 3.0mm
	Projection	
Customer Client	Date	
Drawn By Dessiné Par	BoxCad: BoxCad	Date 21-Jun-23
Material Matière	14 Ga Stainless Steel 316 (1.7mm)	
Color Couleur	Unpainted	Finish Fini Brushed
Description	Detail Rev.	
5412ESSW 72" x 36" x 16" Body		
Part Number Numéro Pièce	Rev.	6
5412ESSW7236166NOIPB	0	9

Qty	Part Number	Rev	Description
1	STK-S-00100	0	3.5" x 2" Silver Milar Flexcon Sticker
1	STK-Q-16085	0	Ground Stud M6 x 16mm Stainless Steel
8	STK-Q-16020	1	Stud M8 x 35mm Stainless Steel
1	5412ESSW7236166NOIP B-P	0	5412ESSW 72" x 36" x 16" Body Part
Parts List			

This drawing is confidential and must not be reproduced or used without the consent of EXM

Ce dessin est confidentiel et ne doit pas être reproduit ou utilisé sans le consentement de EXM

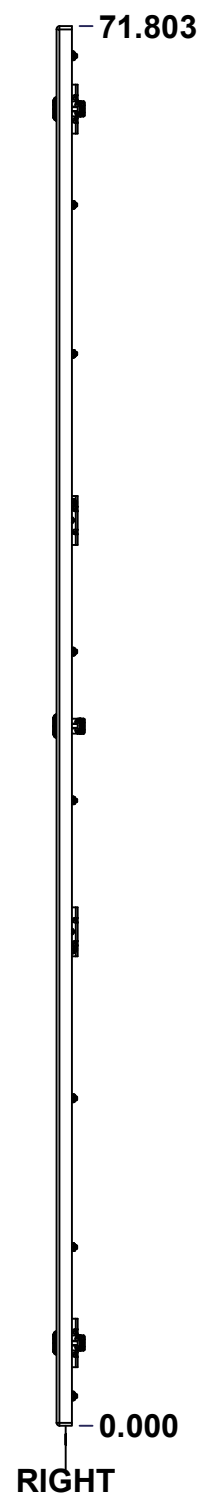
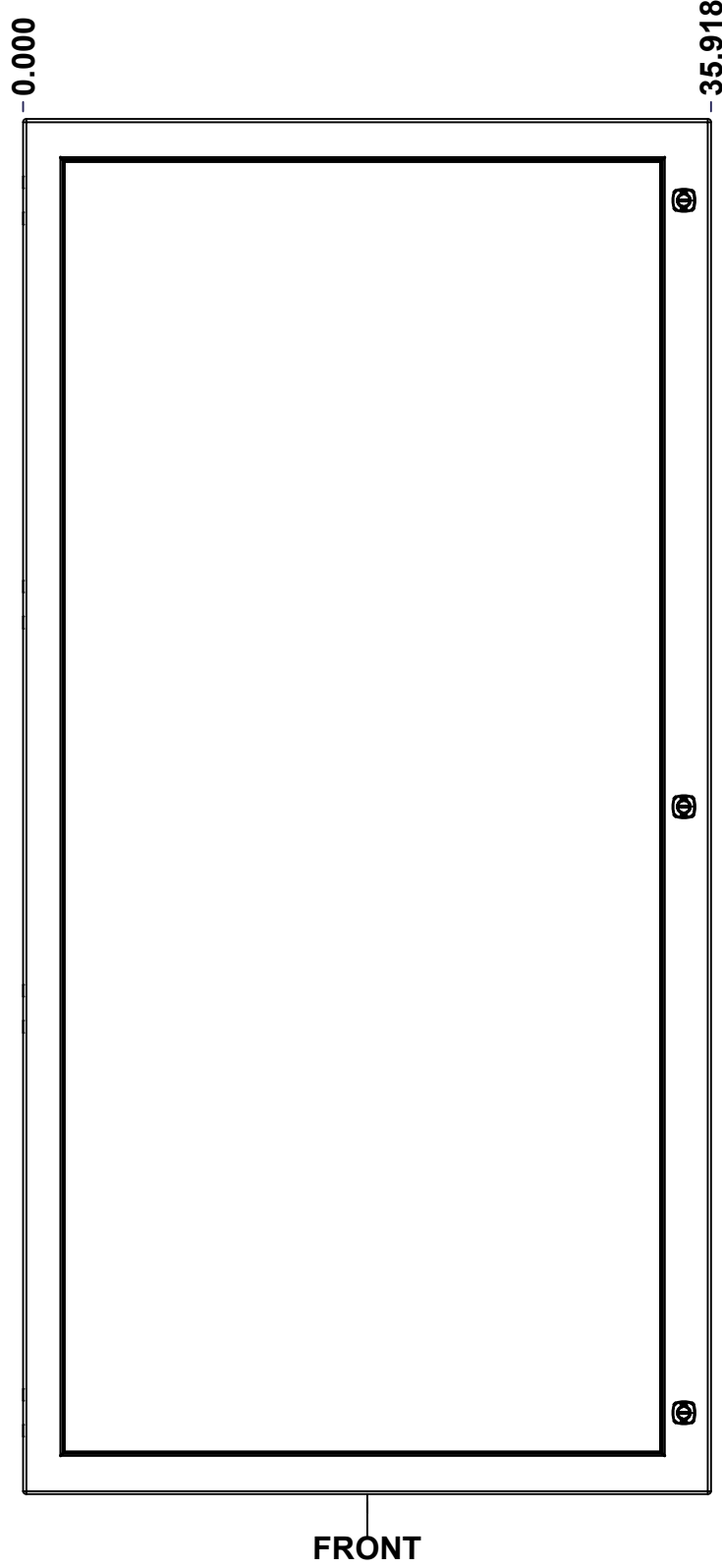
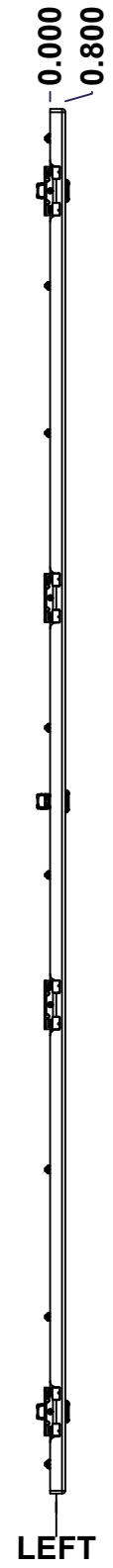
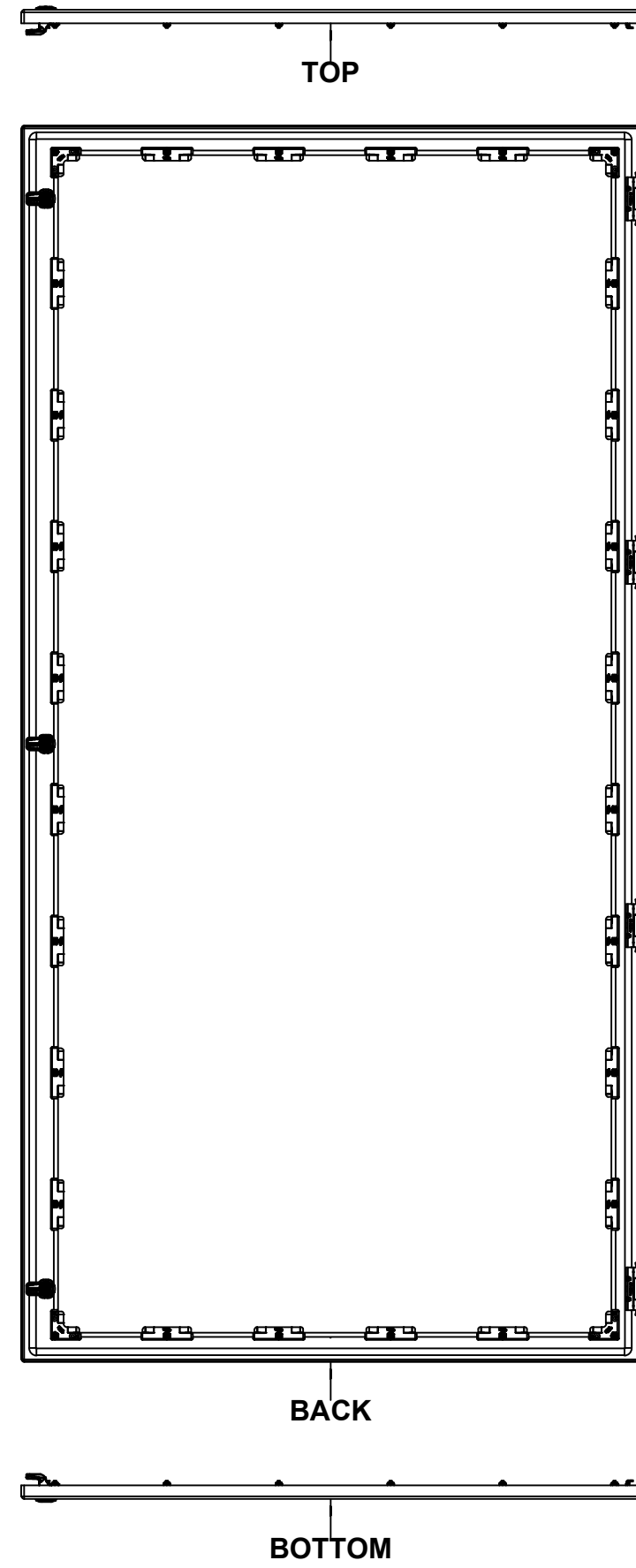

No.	Revisions	Date	By/Par

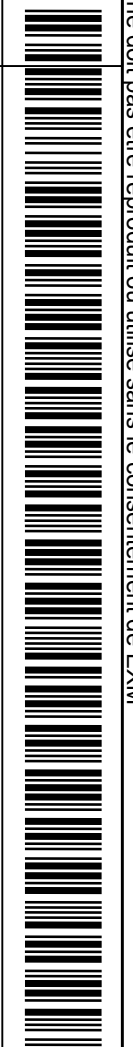
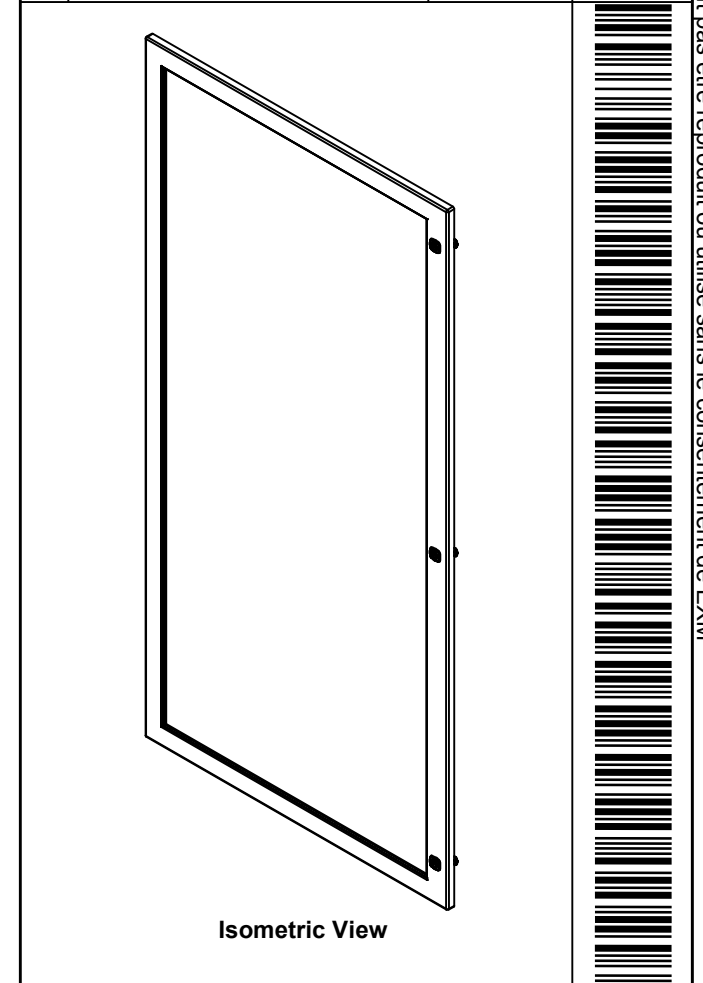

<p>Tél: (450) 979-4373 Fax: (450) 979-4626 www.exmweb.com</p>	Flatness Aplatissement Max 3.0mm
	Projection
Customer Client	Date
Drawn By Dessiné Par BoxCad: BoxCad	Date 21-Jun-23
Material Matière 14 Ga Stainless Steel 316 (1.7mm)	
Color Couleur Unpainted	Finish Fini Brushed
Description 5412ESSW 72" x 36" Cover	Detail Rev.
Part Number Numéro Pièce 5412ESSW7236166NOIPC	Rev. 7
	9

SEE BILL OF MATERIAL ON LAST PAGE

This drawing is confidential and must not be reproduced or used without the consent of EXM

Ce dessin est confidentiel et ne doit pas être reproduit ou utilisé sans le consentement de EXM

STANDARD FEATURES ARE NOT LISTED IN THIS HOLE TABLE			
HOLE TABLE - FRONT VIEW (CUSTOM FEATURE ONLY)			
CUT-OUT	XDIM	YDIM	DESCRIPTION
1	1.469	9.166	STUD M6 x 18mm (Inside)
2	33.968	9.166	STUD M6 x 18mm (Inside)
3	1.469	16.805	STUD M6 x 18mm (Inside)
4	33.968	16.805	STUD M6 x 18mm (Inside)
5	1.469	24.443	STUD M6 x 18mm (Inside)
6	33.968	24.443	STUD M6 x 18mm (Inside)
7	1.469	32.082	STUD M6 x 18mm (Inside)
8	33.968	32.082	STUD M6 x 18mm (Inside)
9	1.469	39.721	STUD M6 x 18mm (Inside)
10	33.968	39.721	STUD M6 x 18mm (Inside)
11	1.469	47.360	STUD M6 x 18mm (Inside)
12	33.968	47.360	STUD M6 x 18mm (Inside)
13	1.469	54.998	STUD M6 x 18mm (Inside)
14	33.968	54.998	STUD M6 x 18mm (Inside)
15	1.469	62.637	STUD M6 x 18mm (Inside)
16	33.968	62.637	STUD M6 x 18mm (Inside)
17	1.469	70.276	STUD M6 x 18mm (Inside)
18	1.469	1.527	STUD M6 x 18mm (Inside)
19	7.969	70.276	STUD M6 x 18mm (Inside)
20	7.969	1.527	STUD M6 x 18mm (Inside)
21	14.469	70.276	STUD M6 x 18mm (Inside)
22	14.469	1.527	STUD M6 x 18mm (Inside)
23	20.968	70.276	STUD M6 x 18mm (Inside)
24	20.968	1.527	STUD M6 x 18mm (Inside)
25	27.468	70.276	STUD M6 x 18mm (Inside)
26	27.468	1.527	STUD M6 x 18mm (Inside)
27	33.968	70.276	STUD M6 x 18mm (Inside)
28	33.968	1.527	STUD M6 x 18mm (Inside)

29	34.494	67.553	880 SCQ4-SLSS6
30	34.494	35.902	880 SCQ4-SLSS6
31	34.494	4.250	880 SCQ4-SLSS6

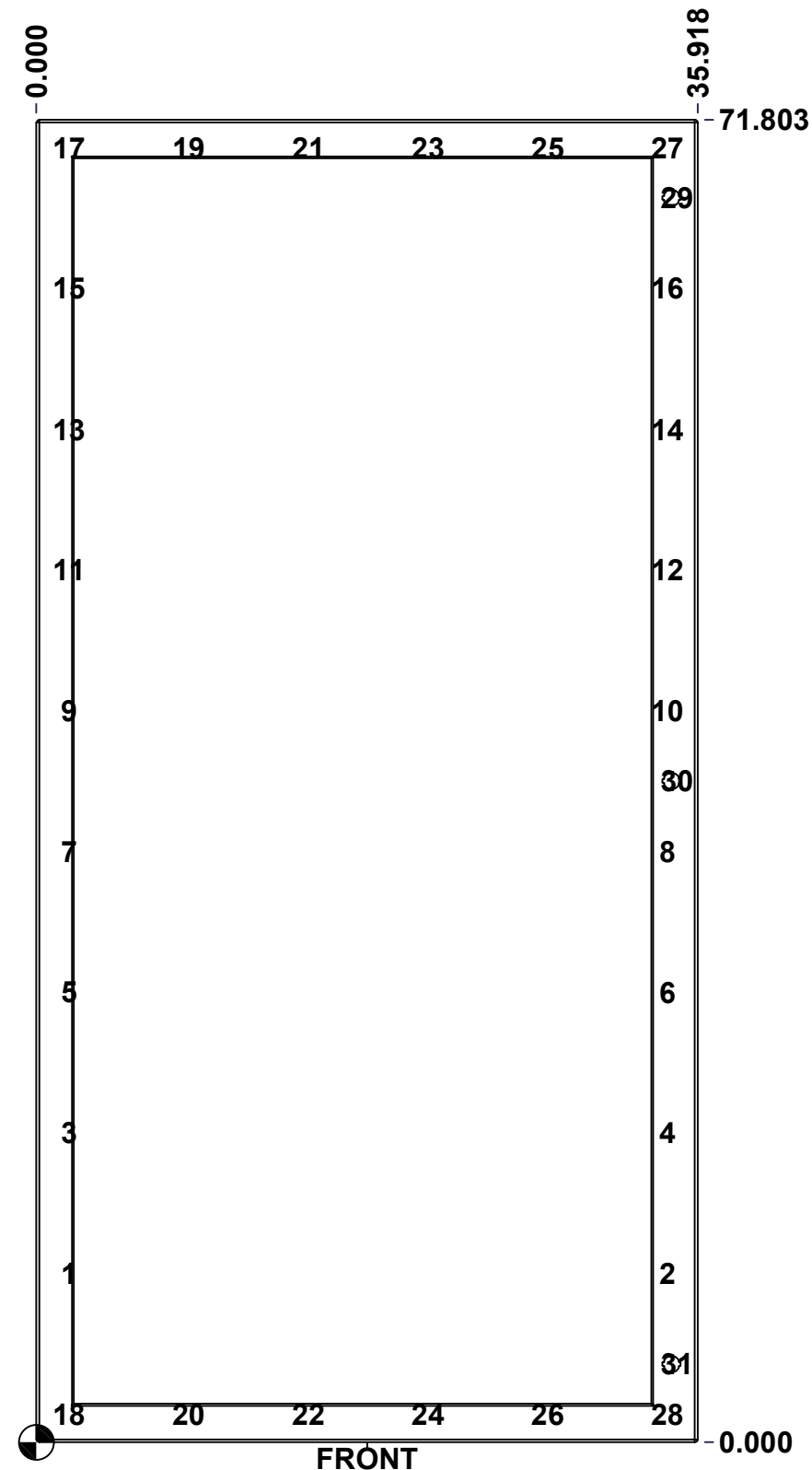

	Description	Status
	5412ESSW 72" x 36" Cover	(NULL)
	Part Number Numéro Pièce	Rev.
	5412ESSW7236166NOIPC	0
		8
		9

This drawing is confidential and must not be reproduced or used without the consent of EXM

Ce dessin est confidentiel et ne doit pas être reproduit ou utilisé sans le consentement de EXM

No.	Revisions	Date	By/Par

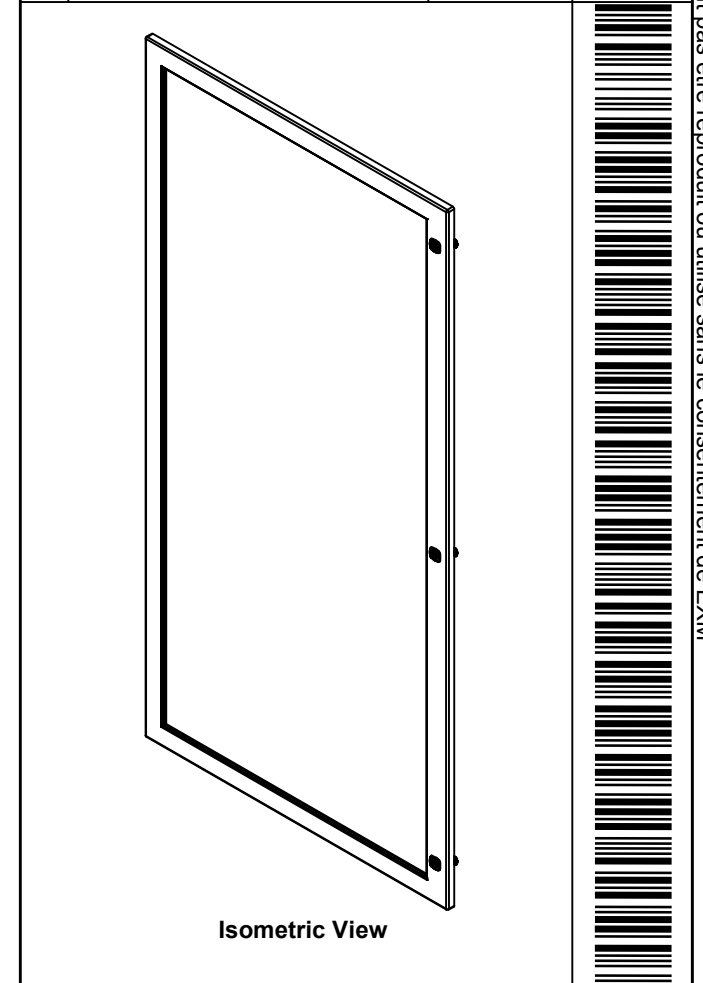

QTY	Part Number	Rev	Description
24	STK-Q-60701	2.1	880 WK - Lexan 1/4" Fixing Bracket
1	STK-A-60703	0	5412 ESW Lexan Bracket Kit
28	STK-Q-16053	1	Stud M6 x 23mm Stainless steel
1	STK-G-02710	0	880 HWKG - Windows Kit Gasket
1	5412ESSW7236166NOIP LXG	0	5412ESSW 72" x 36" Lexan Gasket Part
1	5412ESSW7236166NOIP LX	0	5412ESSW 68.375" x 32.125" Lexan Part
1	5412ESSW7236166NOIP G	0	5412ESSW 72" x 36" Cover Gasket Part
1	5412ESSW7236166NOIP C-P	0	5412ESSW 72" x 36" Cover Part
3	880 SCQ4-SLSS6	7	5412 ESS 1/4 Turn Lock
4	STK-A-33016	0	5412 ESS Bended Hinge (Body Part)
Parts List			

Tél: (450) 979-4373
Fax: (450) 979-4626
www.exmweb.com

Flatness
Aplatissement
Max 3.0mm

Projection

Customer Client	Date
Drawn By / Dessiné Par: BoxCad: BoxCad	Date: 21-Jun-23
Material / Matière: 14 Ga Stainless Steel 316 (1.7mm)	
Color / Couleur: Unpainted	Finish / Fini: Brushed
Description: 5412ESSW 72" x 36" Cover	
Detail Rev.	
Part Number / Numéro Pièce: 5412ESSW7236166NOIPC	Rev. 0