

This drawing is confidential and must not be reproduced or used without the consent of EXM

Ce dessin est confidentiel et ne doit pas être reproduit ou utilisé sans le consentement de EXM

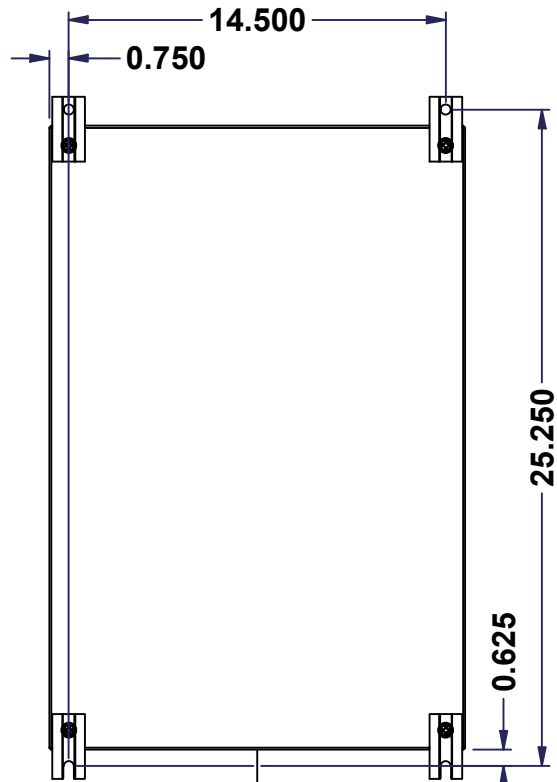

TOP



BACK

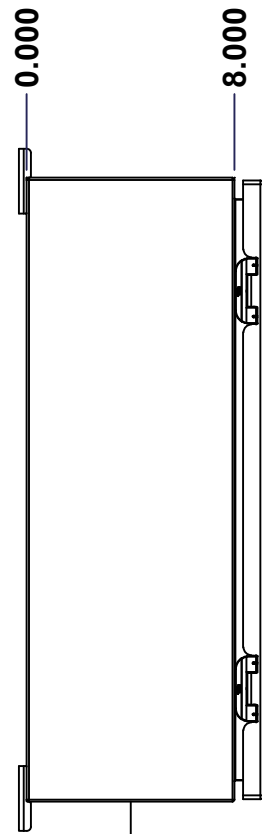

LEFT

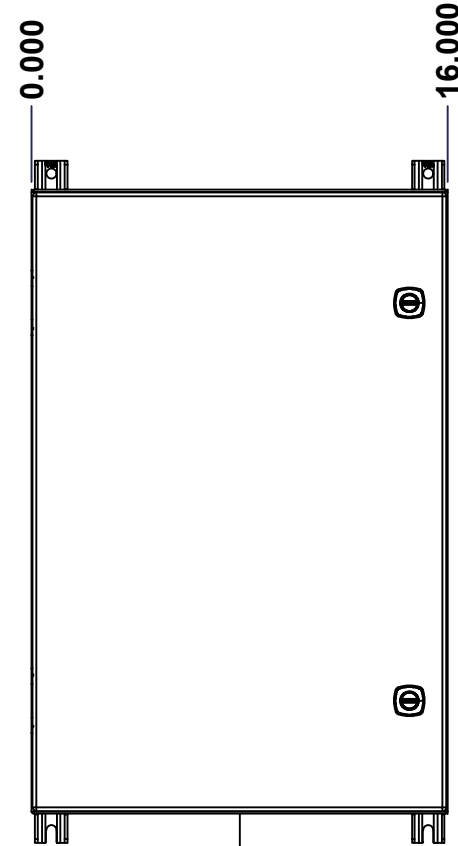

FRONT

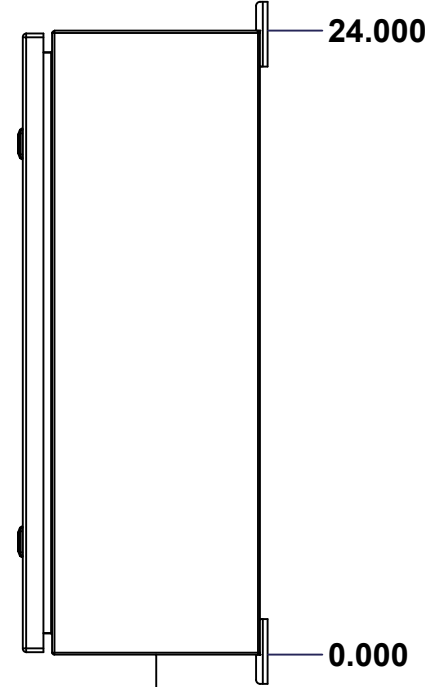

RIGHT

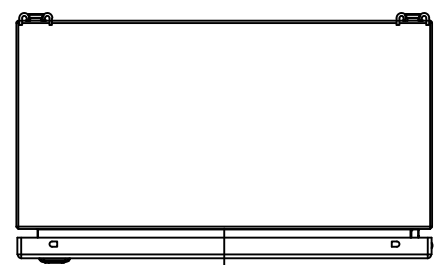

BOTTOM

No.	Revisions	Date	By/Par

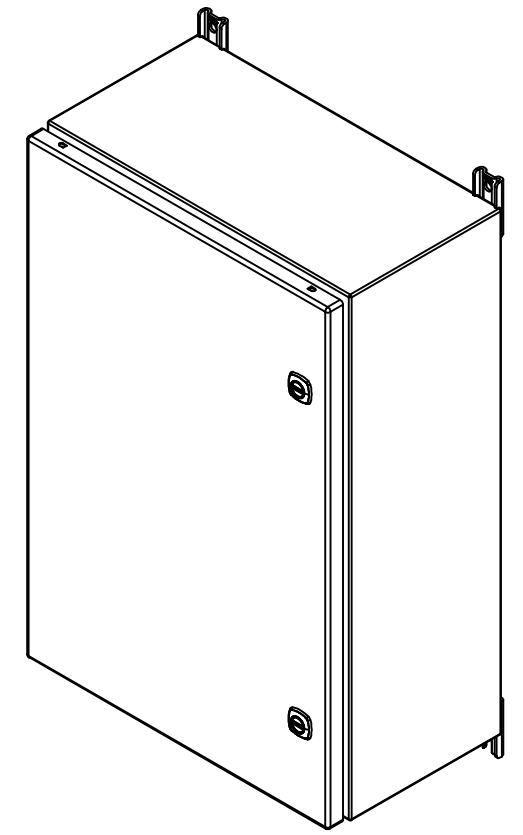

Isometric View



Tél: (450) 979-4373
 Fax: (450) 979-4626
www.exmweb.com

Flatness
Aplatissement
Max 3.0mm
Projection

Customer Client	Date
Drawn By Dessiné Par: BoxCad: BoxCad	Date: 24-Jan-14
Material Matière: 16 Ga Cold Rolled A1008 CS Type B (1.4mm)	

Color Couleur: Asa-61 Grey	Finish Fini: Smooth
----------------------------	---------------------

Description: 5412ESTH 24" x 16" x 8" Assembly	Detail Rev.
---	-------------

Part Number Numéro Pièce: 5412ESTH241608	Rev. 0	1
--	--------	---

SEE BILL OF MATERIAL ON LAST PAGE

This drawing is confidential and must not be reproduced or used without the consent of EXM

Ce dessin est confidentiel et ne doit pas être reproduit ou utilisé sans le consentement de EXM

NOTE	
ITEM	DESCRIPTION
1	NEMA 4/12 Enclosure
2	C/W Standard ground studs on box and cover
3	C/W Standard door stiffener
4	C/W Standard inner panel (Included)
5	C/W Standard inner panel mounting studs
6	C/W 885 ESMF3_CLOSE Sold separately (Installed)
7	C/W 885 ESMF3_OPEN Sold separately (Installed)
8	C/W R5 Insulation (Installed by EXM)

No.	Revisions	Date	By/Par

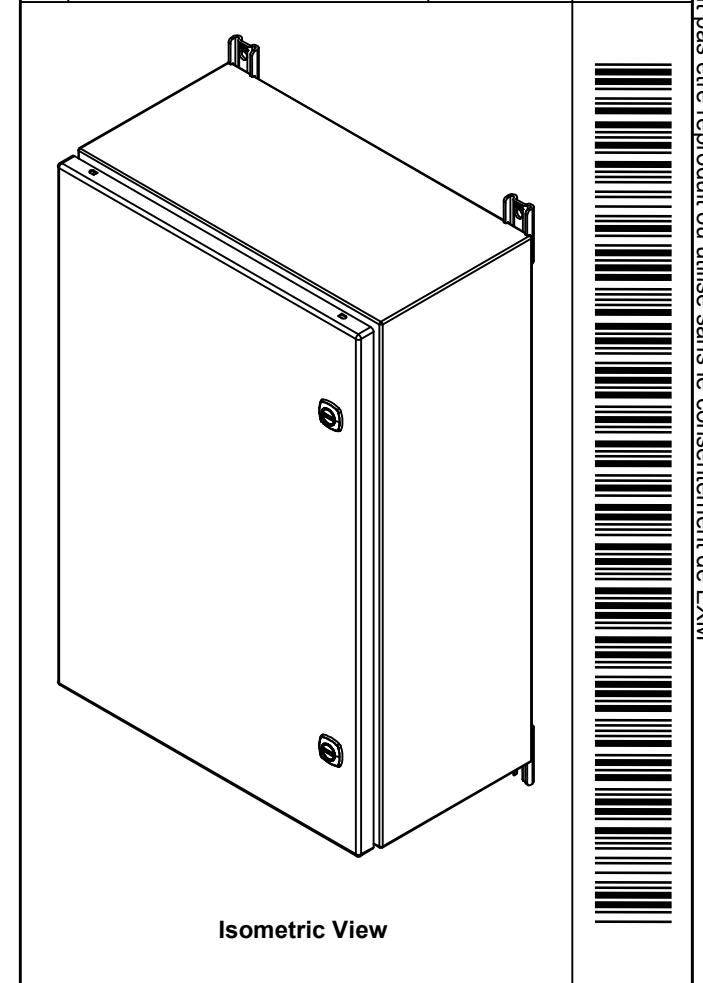

	Tél: (450) 979-4373 Fax: (450) 979-4626 www.exmweb.com	Flatness Aplatissement
		Max 3.0mm
Projection		
Customer Client	Date	
Drawn By Dessiné Par	BoxCad: BoxCad	Date 24-Jan-14
Material Matière	16 Ga Cold Rolled A1008 CS Type B (1.4mm)	

PACKING		
ITEM	QTY	DESCRIPTION
Cardboard sleeve	2	Top and Bottom
Cardboard strip	2	Between back of enclosure and inner panel
Plastic bag	1	To protect cover surface and inside gasket
Plastic strap - Black	2	To Squeeze the 2 cardboard sleeve together
Packaging label	1	White label with product number

Qty	Part Number	Rev	Description
4	STK-Q-00600	2	M12 to M8 Adaptor
1	881 SP2416G	0	881 SP - Inner Panel
1	STK-K-01800	5	5412 ES Accessory Kit
1	5412ESTH241608C	0	5412ESTH 24" x 16" Cover
1	5412ESTH241608B	0	5412ESTH 24" x 16" x 8" Body
2	STK-Q-04050-08	0	M6 x 8mm Hexagon Socket Head Machine Screw
Parts List			

Color Couleur	Asa-61 Grey	Finish Fini	Smooth
Description	5412ESTH 24" x 16" x 8" Assembly		Detail Rev.
Part Number Numéro Pièce	5412ESTH241608		Rev. 0
			2 / 16

This drawing is confidential and must not be reproduced or used without the consent of EXM

Ce dessin est confidentiel et ne doit pas être reproduit ou utilisé sans le consentement de EXM

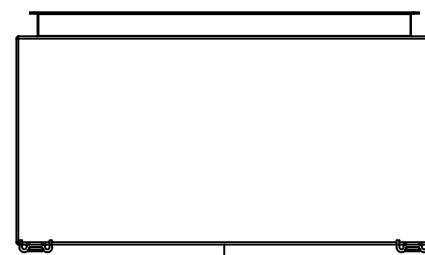

TOP

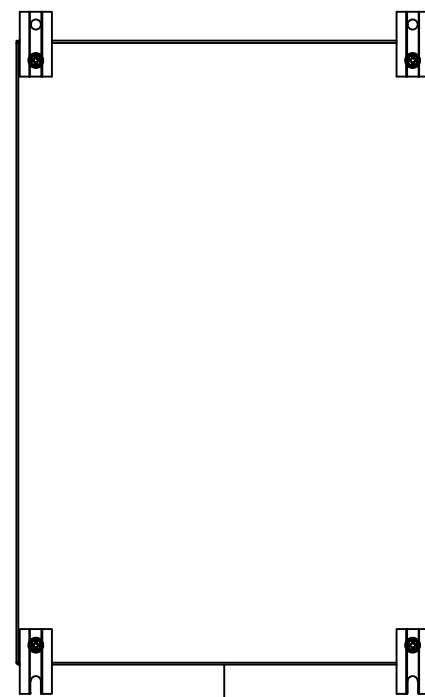

BACK

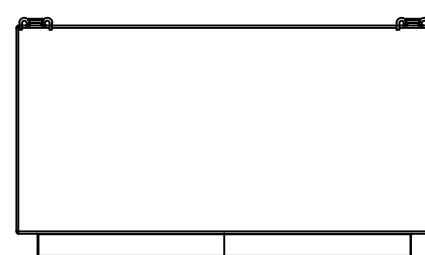

BOTTOM

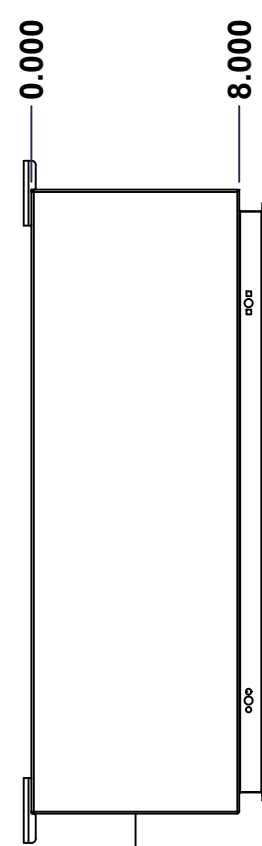

LEFT

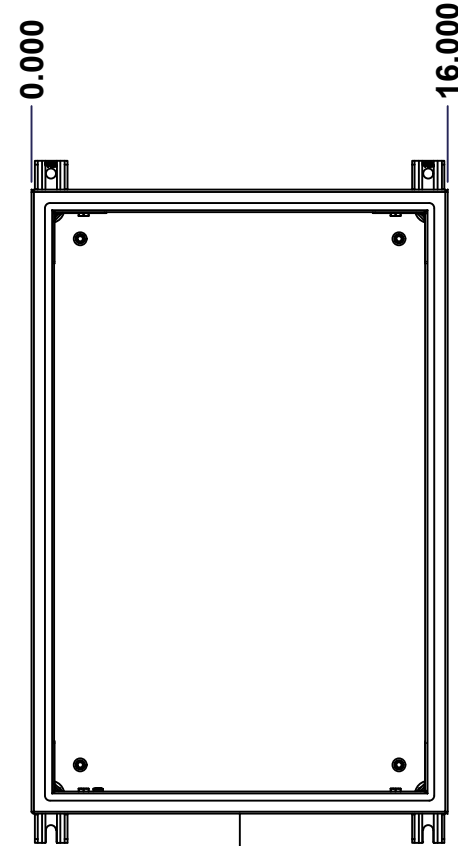

FRONT

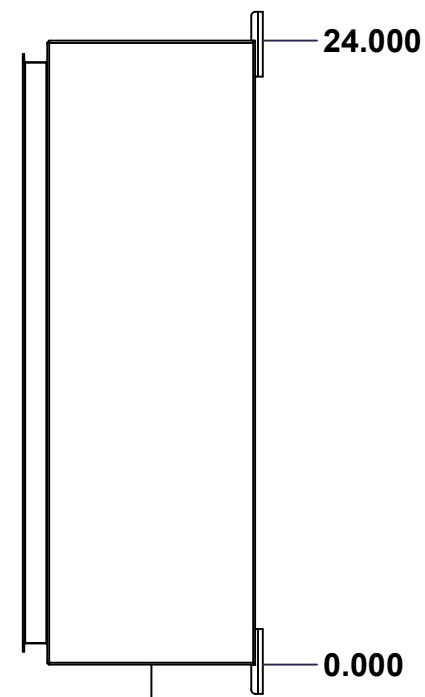

RIGHT

No.	Revisions	Date	By/Par

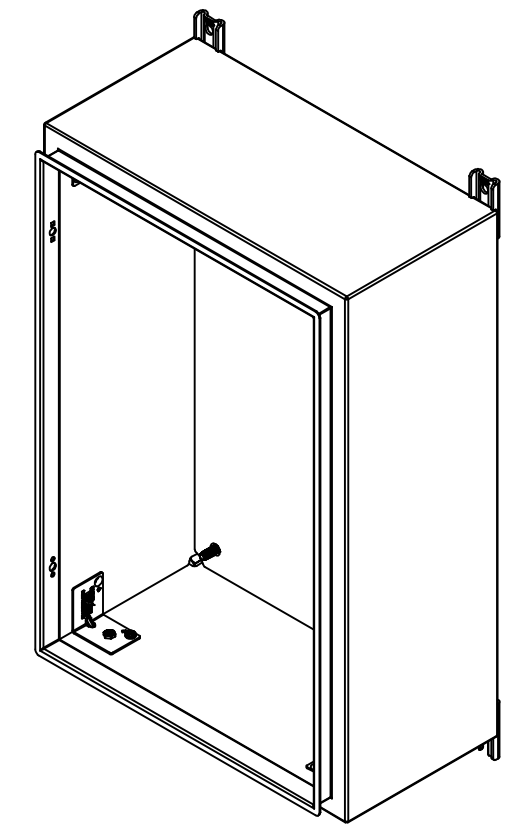

Isometric View

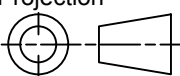

 Tél: (450) 979-4373 Fax: (450) 979-4626 www.exmweb.com		Flatness Aplatissement Max 3.0mm Projection 
Customer Client	Date	
Drawn By Dessiné Par	BoxCad: BoxCad	Date 24-Jan-14
Material Matière	16 Ga Cold Rolled A1008 CS Type B (1.4mm)	
Color Couleur	Asa-61 Grey	Finish Fini Smooth
Description 5412ESTH 24" x 16" x 8" Body		Detail Rev.
Part Number Numéro Pièce	Rev. 0	3 / 16

SEE BILL OF MATERIAL ON LAST PAGE

5412ESTH241608B

This drawing is confidential and must not be reproduced or used without the consent of EXM

Ce dessin est confidentiel et ne doit pas être reproduit ou utilisé sans le consentement de EXM

STANDARD FEATURES ARE NOT LISTED IN THIS HOLE TABLE			
HOLE TABLE - TOP VIEW (CUSTOM FEATURE ONLY)			
CUT-OUT	XDIM	YDIM	DESCRIPTION
1	2.000	6.500	INSUL. STUD M6 x 18mm (Inside)
2	14.000	6.500	INSUL. STUD M6 x 18mm (Inside)

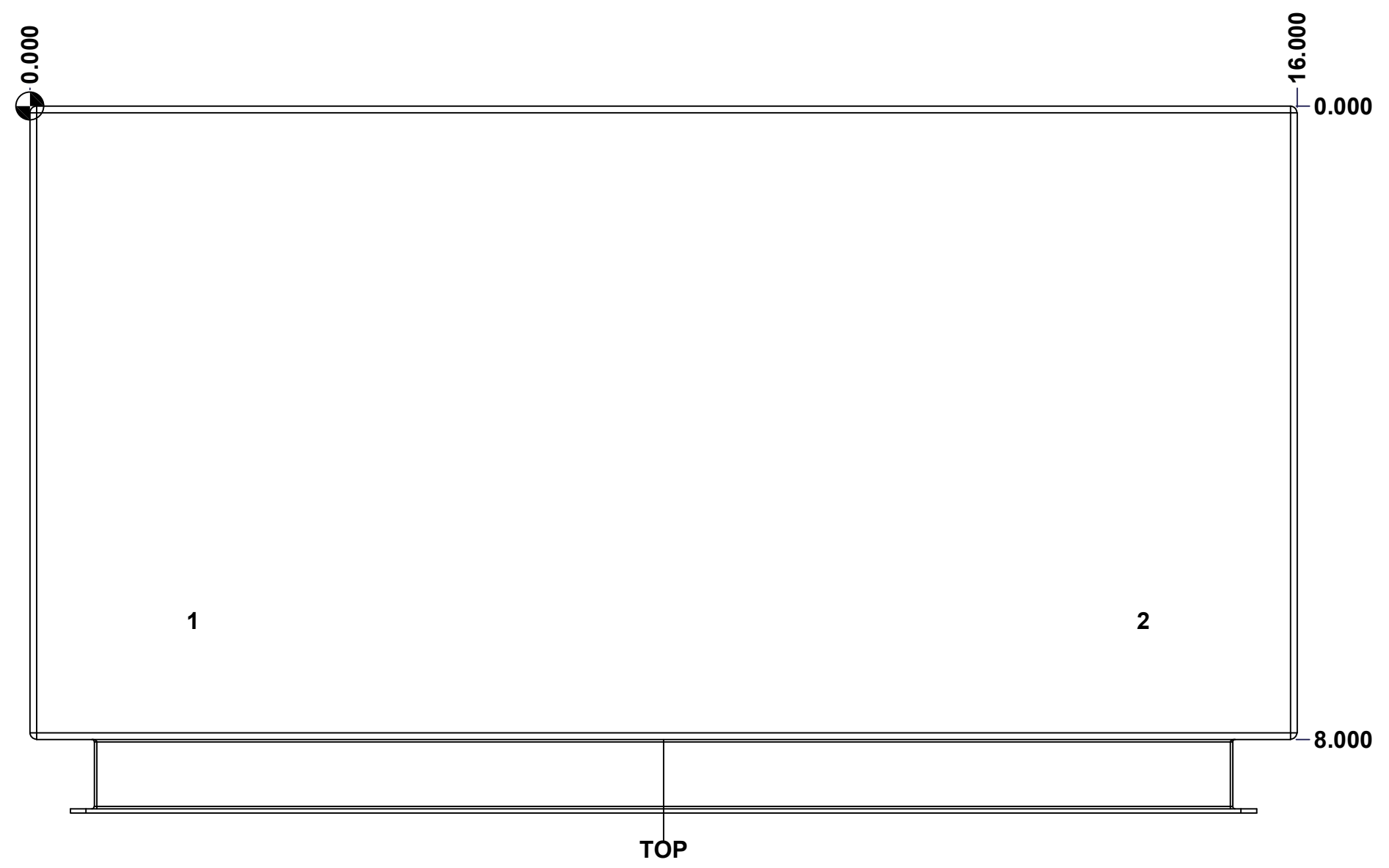

	Description	Status
	5412ESTH 24" x 16" x 8" Body	(NULL)
Part Number Numéro Pièce 5412ESTH241608B	Rev.	4
	0	16

This drawing is confidential and must not be reproduced or used without the consent of EXM

Ce dessin est confidentiel et ne doit pas être reproduit ou utilisé sans le consentement de EXM

STANDARD FEATURES ARE NOT LISTED IN THIS HOLE TABLE			
HOLE TABLE - BOTTOM VIEW (CUSTOM FEATURE ONLY)			
CUT-OUT	XDIM	YDIM	DESCRIPTION
1	2.000	6.500	INSUL. STUD M6 x 18mm (Inside)
2	14.000	6.500	INSUL. STUD M6 x 18mm (Inside)

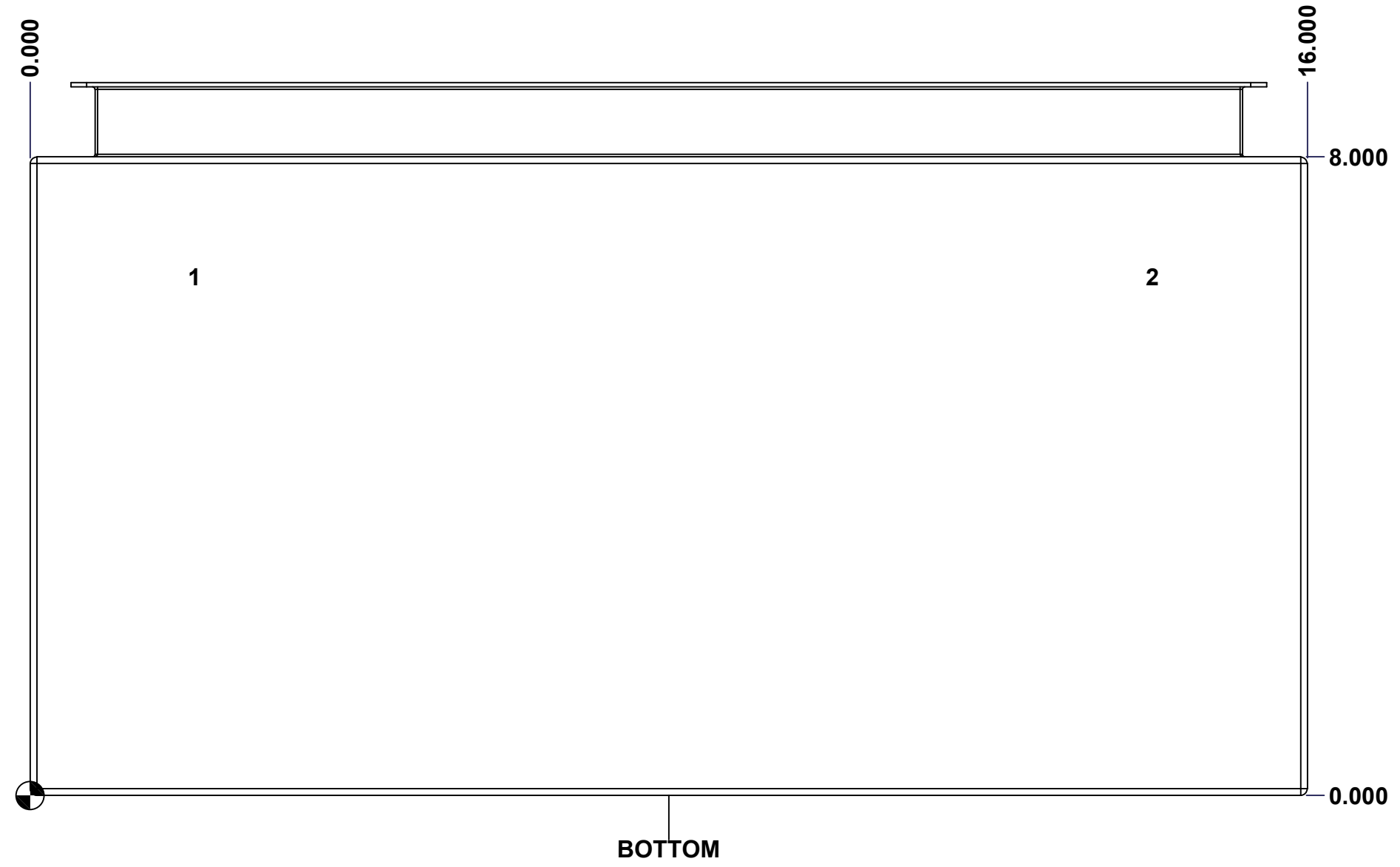

	Description	Status	
	5412ESTH 24" x 16" x 8" Body	(NULL)	
	Part Number Numéro Pièce	Rev.	5
	5412ESTH241608B	0	16

This drawing is confidential and must not be reproduced or used without the consent of EXM

Ce dessin est confidentiel et ne doit pas être reproduit ou utilisé sans le consentement de EXM

STANDARD FEATURES ARE NOT LISTED IN THIS HOLE TABLE

HOLE TABLE - BACK VIEW (CUSTOM FEATURE ONLY)

CUT-OUT	XDIM	YDIM	DESCRIPTION
1	1.875	1.875	IP STUD M8 x 35mm (Inside)
2	1.875	22.125	IP STUD M8 x 35mm (Inside)
3	14.125	22.125	IP STUD M8 x 35mm (Inside)
4	14.125	1.875	IP STUD M8 x 35mm (Inside)

5	15.250	24.000	FOOT 885 ESMF3_CLOSE
6	0.750	24.000	FOOT 885 ESMF3_CLOSE
7	15.250	0.000	FOOT 885 ESMF3_OPEN
8	0.750	0.000	FOOT 885 ESMF3_OPEN

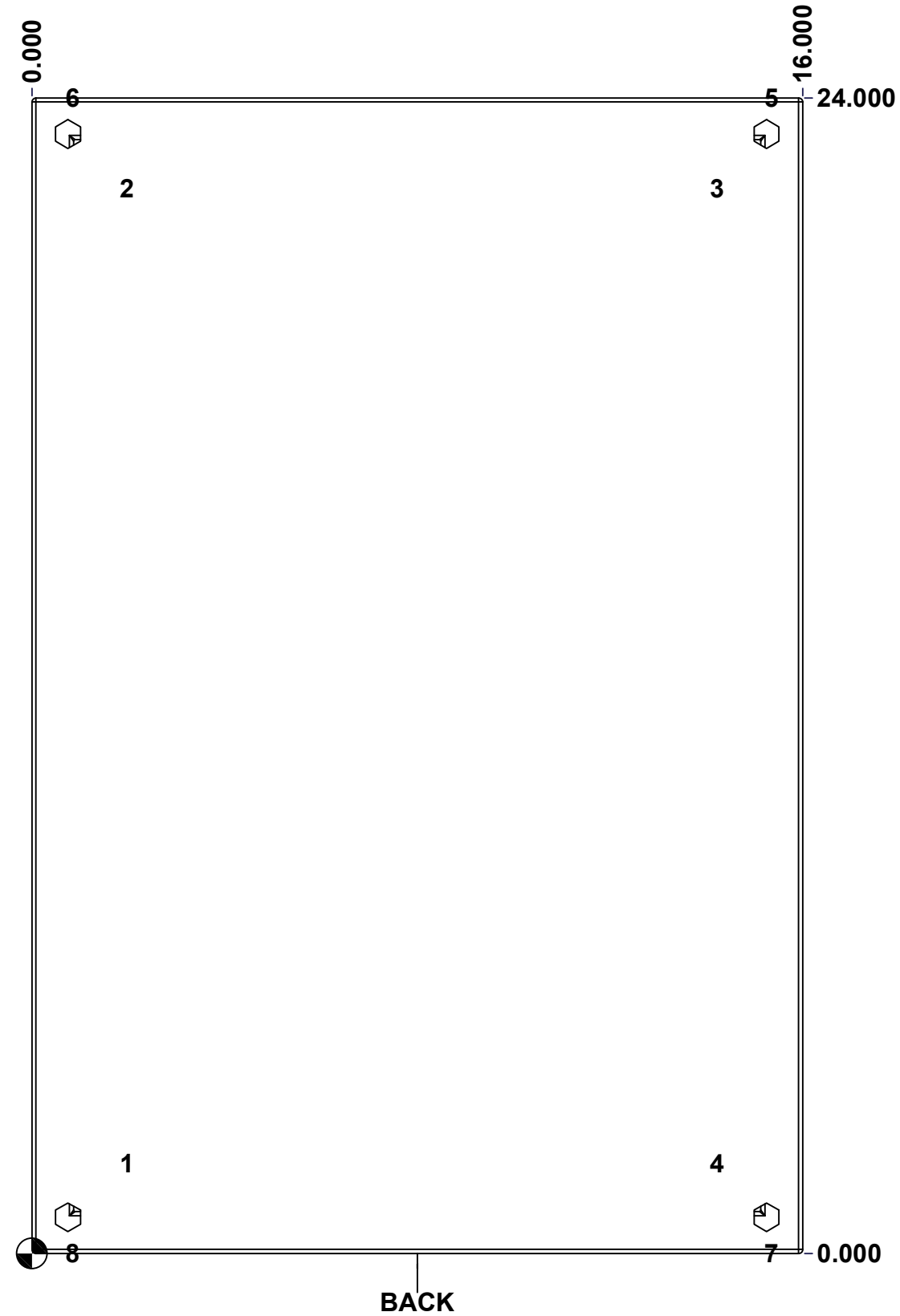

	Description		Status
	5412ESTH 24" x 16" x 8" Body		(NULL)
	Part Number Numéro Pièce		Rev.
	5412ESTH241608B		0 / 6
			16

This drawing is confidential and must not be reproduced or used without the consent of EXM

Ce dessin est confidentiel et ne doit pas être reproduit ou utilisé sans le consentement de EXM

No.	Revisions	Date	By/Par

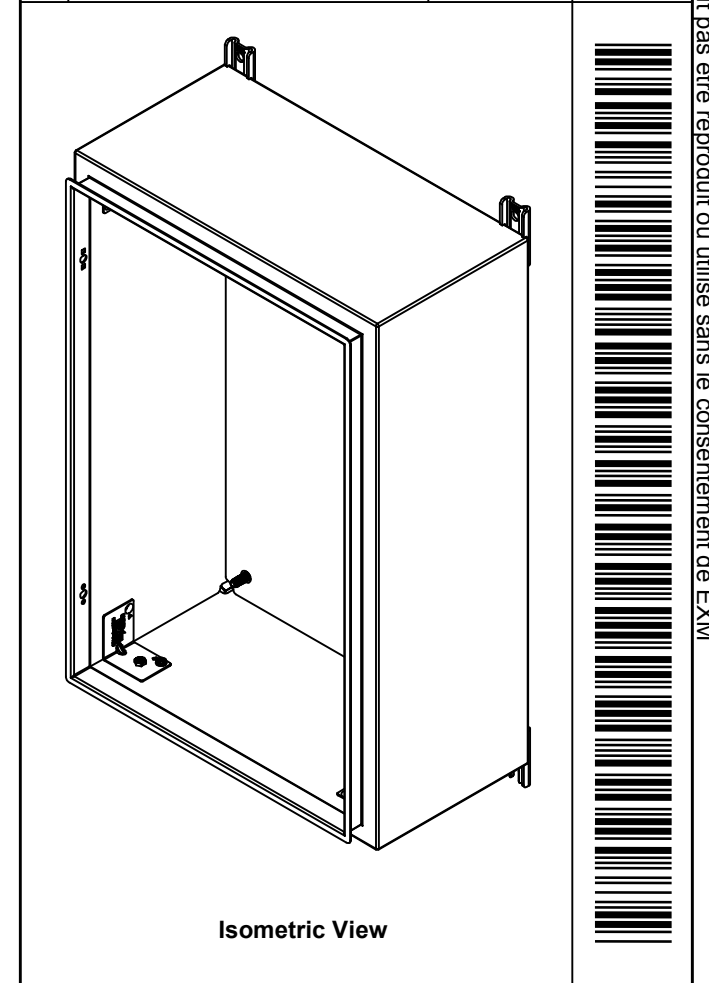

2	885ESMF3-FEET-A	0	885 ESMF3 Mounting Foot (Opened Slot)
4	RIVET_NUT_M10_FH_CE	0	Rivet Nut M10 (Low Profile Close End)
4	STK-Q-06660	2	M10 x 16mm Machine Screw
2	885ESMF3-FEET	0	885 ESMF3 Mounting Foot
1	STK-K-70554	3	5412 ESTH Accessory Kit
1	5412ESTH241608I-RS	0	5412ESTH 24" x 16" Right Insulation
1	5412ESTH241608I-LS	0	5412ESTH 24" x 16" Left Insulation
1	5412ESTH241608I-BT	0	5412ESTH 24" x 16" Top and Bottom Insulation
1	5412ESTH241608I-TP	0	5412ESTH 24" x 16" Top and Bottom Insulation
1	5412ESTH241608I-B	0	5412ESTH 24" x 16" Back Insulation
4	STK-Q-16055	1	M6 x 18mm Stud (No Paint Cap Required)
1	STK-P-02400S	0	Powder Paint (Asa-61 Grey / Smooth)
4	STK-Q-16005	1	Stud M8 x 35 (No Paint Cap Required)
1	5412ESTH241608B-P	0	5412ESTH 24" x 16" x 8" Body Part

Qty	Part Number	Rev	Description
Parts List			

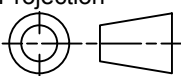
 Tél: (450) 979-4373 Fax: (450) 979-4626 www.exmweb.com	Flatness Aplatissement	Max 3.0mm
	Projection	
Customer Client	Date	
Drawn By Dessiné Par	BoxCad: BoxCad	Date 24-Jan-14
Material Matière	16 Ga Cold Rolled A1008 CS Type B (1.4mm)	
Color Couleur	Asa-61 Grey	Finish Fini Smooth
Description	Detail Rev.	
5412ESTH 24" x 16" x 8" Body		
Part Number Numéro Pièce	Rev.	7
5412ESTH241608B	0	16

This drawing is confidential and must not be reproduced or used without the consent of EXM

Ce dessin est confidentiel et ne doit pas être reproduit ou utilisé sans le consentement de EXM

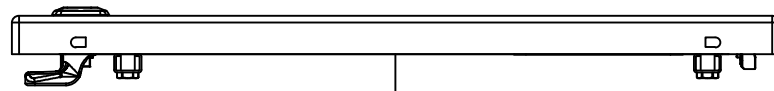

TOP

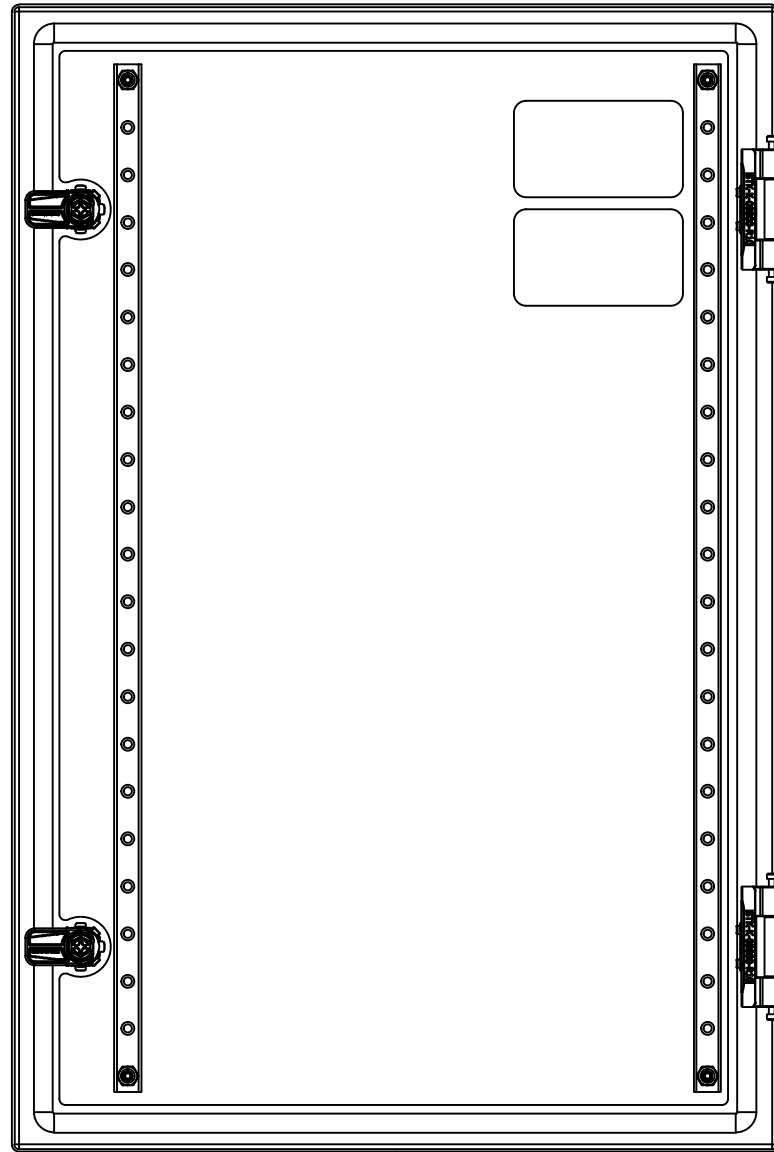

BACK

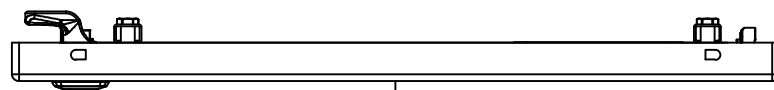

BOTTOM

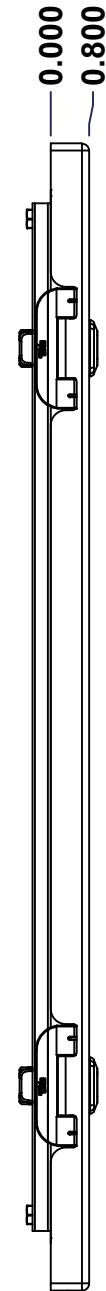

LEFT

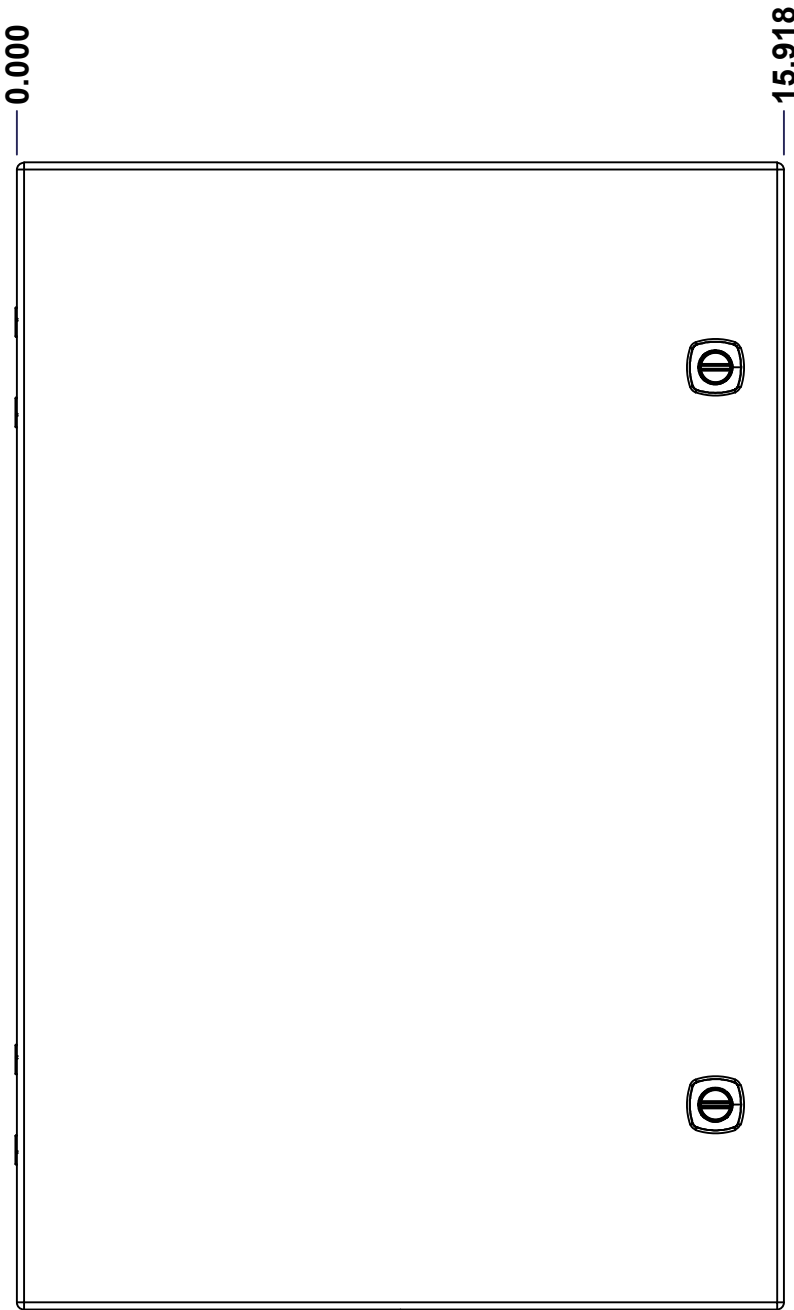

FRONT

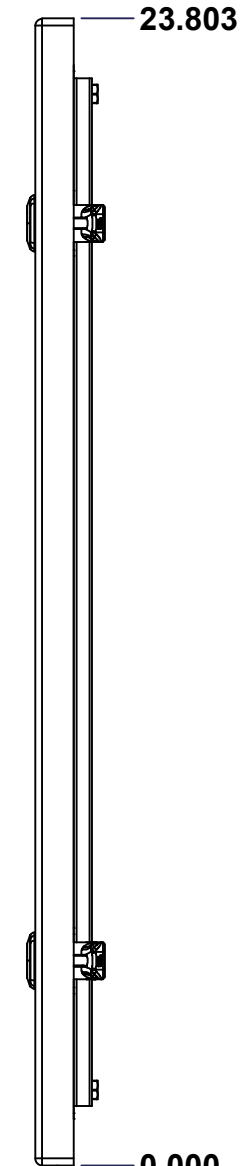

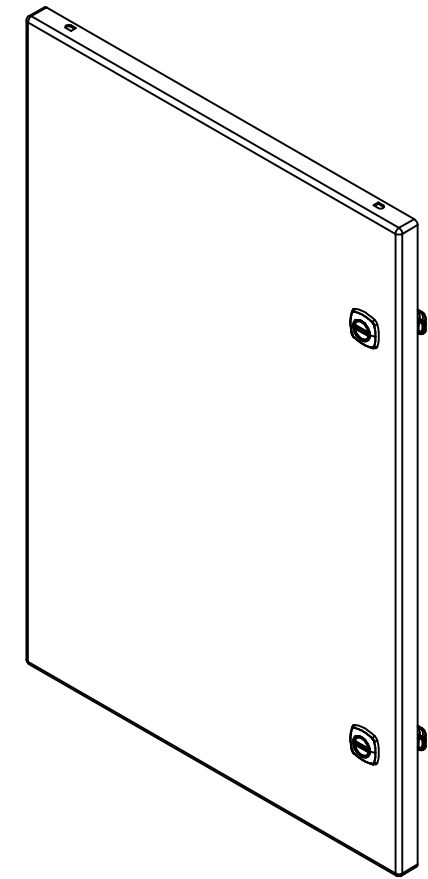

RIGHT



Isometric View

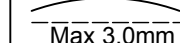

No.	Revisions	Date	By/Par

 Tél: (450) 979-4373 Fax: (450) 979-4626 www.exmweb.com		Flatness Aplatissement  Max 3.0mm Projection 
Customer Client	Date	
Drawn By Dessiné Par	BoxCad: BoxCad	Date 24-Jan-14
Material Matière	16 Ga Cold Rolled A1008 CS Type B (1.4mm)	
Color Couleur	Asa-61 Grey	Finish Fini Smooth
Description 5412ESTH 24" x 16" Cover		Detail Rev.
Part Number Numéro Pièce	Rev. 0	8 / 16

SEE BILL OF MATERIAL ON LAST PAGE

5412ESTH241608C

This drawing is confidential and must not be reproduced or used without the consent of EXM

Ce dessin est confidentiel et ne doit pas être reproduit ou utilisé sans le consentement de EXM

STANDARD FEATURES ARE NOT LISTED IN THIS HOLE TABLE

HOLE TABLE - FRONT VIEW (CUSTOM FEATURE ONLY)

CUT-OUT	XDIM	YDIM	DESCRIPTION
1	1.486	1.567	STUD M6 x 18mm (Inside)
2	1.486	22.236	STUD M6 x 18mm (Inside)
3	13.517	22.236	STUD M6 x 18mm (Inside)
4	13.517	1.567	STUD M6 x 18mm (Inside)

5	14.494	19.553	880 SCQ4-SL
6	14.494	4.250	880 SCQ4-SL

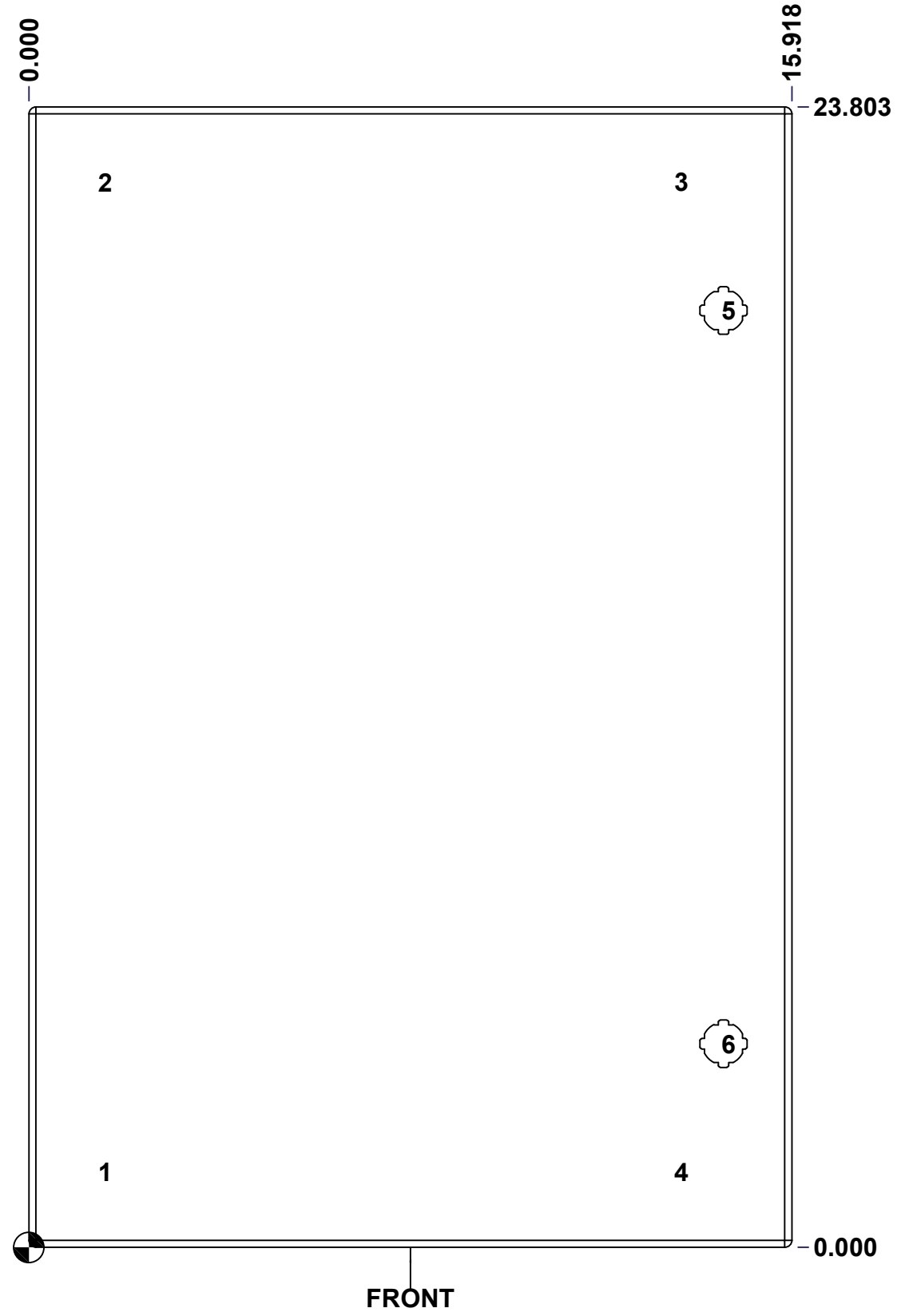

FRONT

	Description	Status	
	5412ESTH 24" x 16" Cover	(NULL)	
	Part Number Numéro Pièce	Rev.	9
	5412ESTH241608C	0	16

This drawing is confidential and must not be reproduced or used without the consent of EXM

Ce dessin est confidentiel et ne doit pas être reproduit ou utilisé sans le consentement de EXM

No.	Revisions	Date	By/Par

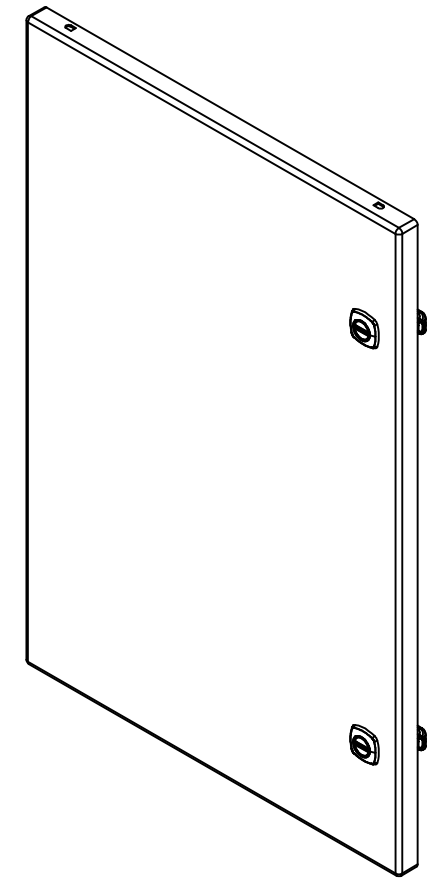

Isometric View



Tél: (450) 979-4373
 Fax: (450) 979-4626
www.exmweb.com

Flatness
Aplatissement

Max 3.0mm

Projection

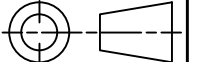

2	STK-S-00100	0	3.5" x 2" Silver Milar Flexcon Sticker
4	STK-Q-07250	2	M6 x 16mm Collar Nut
2	STK-Q-46020-24	5	5412 ES Vertical Door Stiffener 24"
1	5412ESTH241608I-C	0	5412ESTH 24" x 16" Cover Insulation
1	STK-P-02400S	0	Powder Paint (Asa-61 Grey / Smooth)
4	STK-Q-16055	1	M6 x 18mm Stud (No Paint Cap Required)
1	5412ESTH241608G	0	5412ESTH 24" x 16" Cover Gasket Part
1	5412ESTH241608C-P	0	5412ESTH 24" x 16" Cover Part
2	STK-K-09800	10	5412 ES Hinge with 2 Captive Hinge Pins
2	STK-K-12500	16	5412 ES 1/4 Turn Lock

Customer Client _____ Date _____

Drawn By / Dessiné Par BoxCad: BoxCad Date 24-Jan-14

Material Matière 16 Ga Cold Rolled A1008 CS Type B (1.4mm)

Color Couleur Asa-61 Grey Finish Fini Smooth

Description 5412ESTH 24" x 16" Cover Detail Rev. _____

Part Number Numéro Pièce **5412ESTH241608C** Rev. **0** 10/16

QTY	Part Number	Rev	Description
Parts List			

This drawing is confidential and must not be reproduced or used without the consent of EXM

Ce dessin est confidentiel et ne doit pas être reproduit ou utilisé sans le consentement de EXM

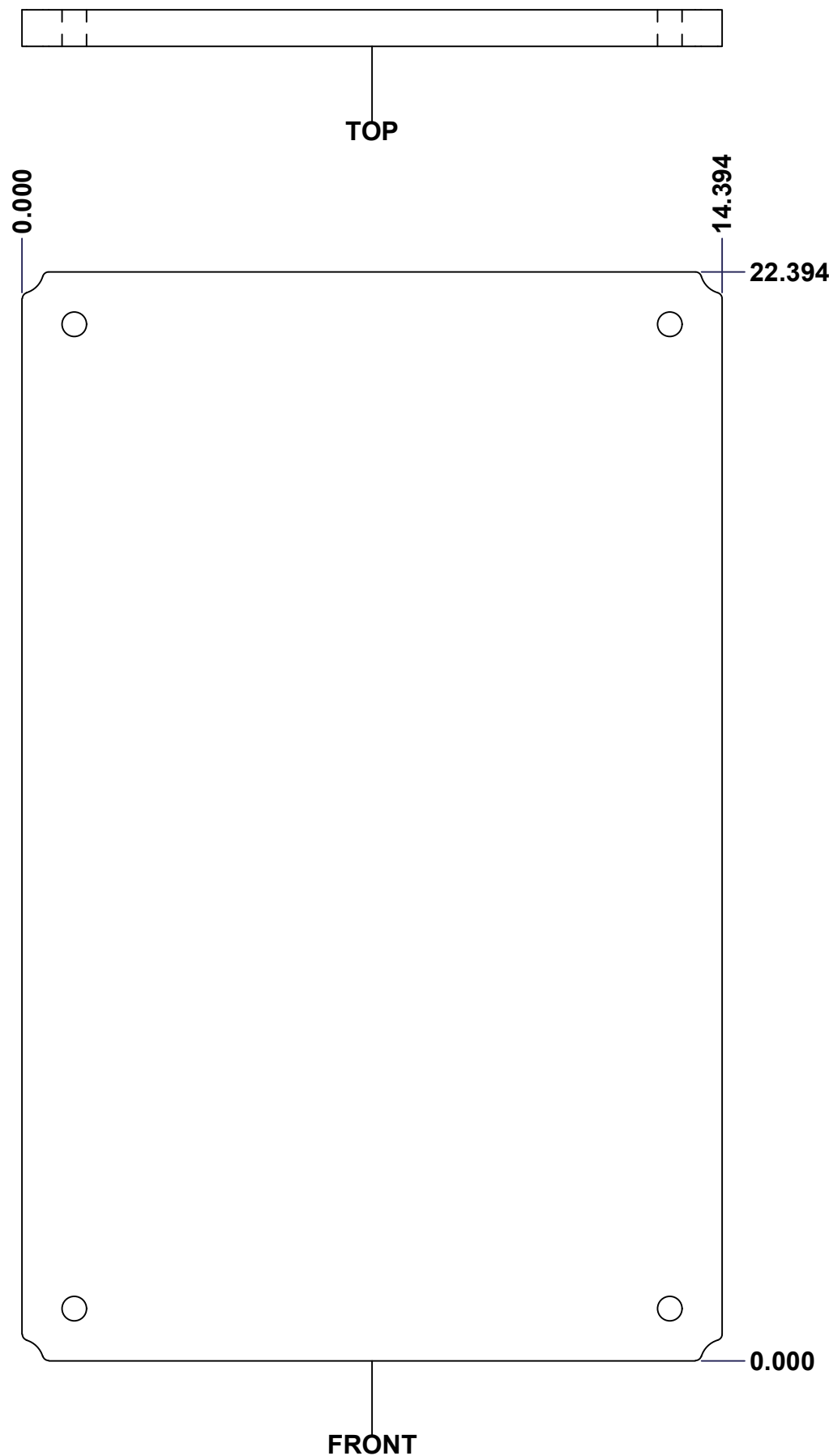

No.	Revisions	Date	By/Par

Isometric View

Tél: (450) 979-4373 Fax: (450) 979-4626 www.exmweb.com		Flatness Aplatissement Max 3.0mm Projection
Customer Client	Date	
Drawn By / Dessiné Par: BoxCad: Patrick Deschenes	Date: 23-Jan-07	
Material / Matière: Polyisocyanurate		
Color / Couleur: Aluminum	Finish / Fini: N/A	
Description: 5412ESTH 24" x 16" Back Insulation		Detail Rev.
Part Number / Numéro Pièce: 5412ESTH241608I-B	Rev. 0	11 / 16

SEE BILL OF MATERIAL ON LAST PAGE

This drawing is confidential and must not be reproduced or used without the consent of EXM

Ce dessin est confidentiel et ne doit pas être reproduit ou utilisé sans le consentement de EXM

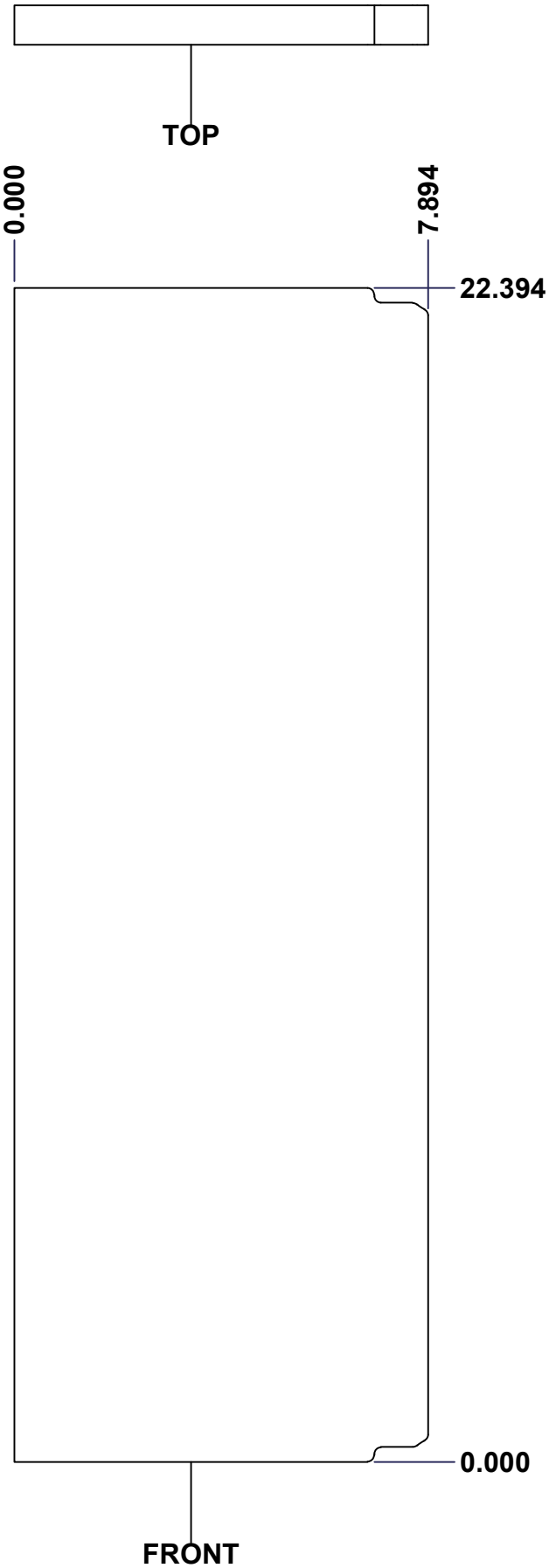

SEE BILL OF MATERIAL ON LAST PAGE

No.	Revisions	Date	By/Par

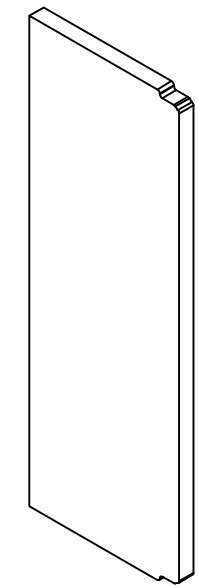

Isometric View

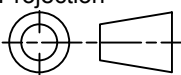
 Tél: (450) 979-4373 Fax: (450) 979-4626 www.exmweb.com	Flatness Aplatissement	Max 3.0mm
	Projection	
Customer Client	Date	
Drawn By Dessiné Par	BoxCad: Patrick Deschenes	Date 23-Jan-07
Material Matière	Polyisocyanurate	
Color Couleur	Aluminum	Finish Fini N/A
Description	Detail Rev.	
5412ESTH 24" x 16" Left Insulation		
Part Number Numéro Pièce	Rev.	12
5412ESTH241608I-LS	0	16

This drawing is confidential and must not be reproduced or used without the consent of EXM

Ce dessin est confidentiel et ne doit pas être reproduit ou utilisé sans le consentement de EXM

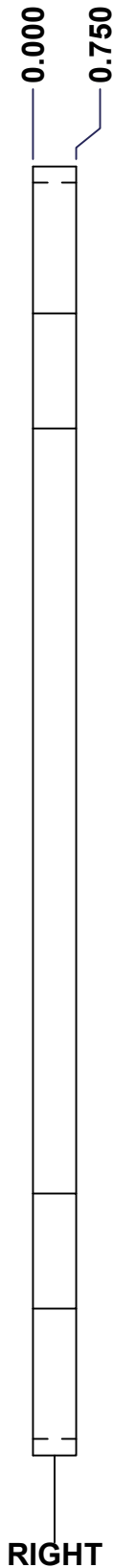
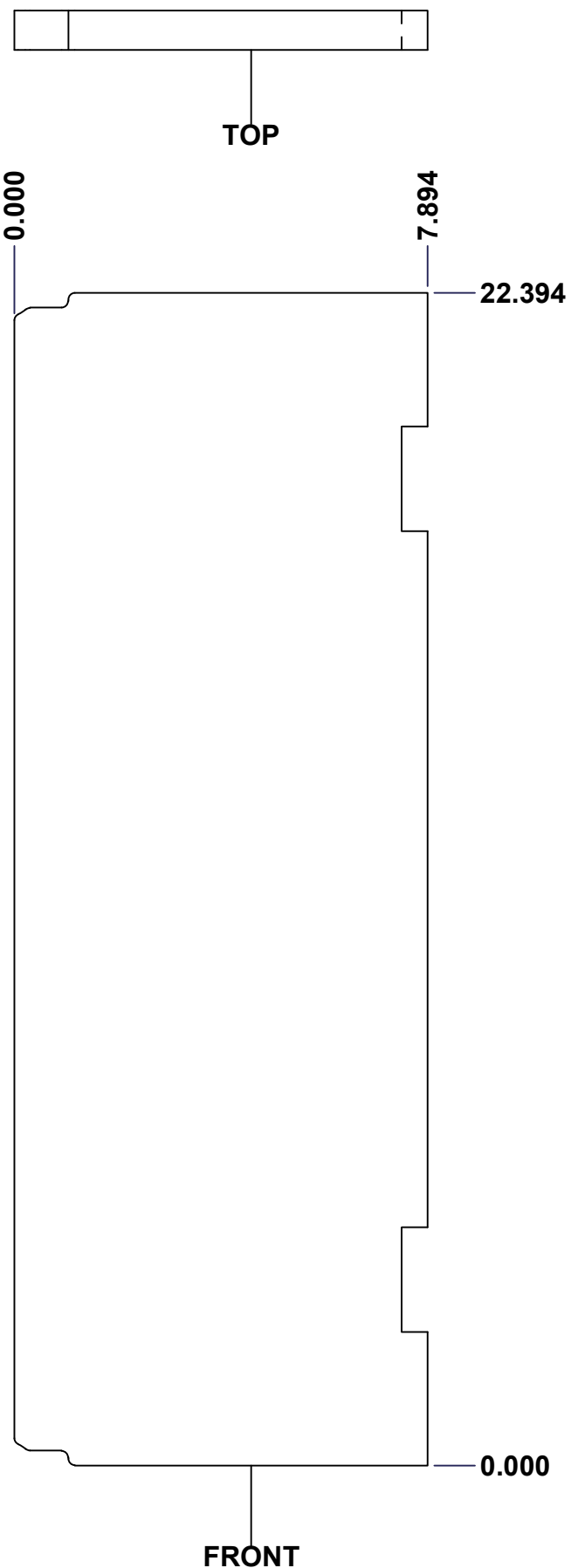

No.	Revisions	Date	By/Par

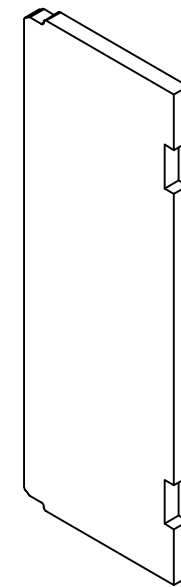

Isometric View



Tél: (450) 979-4373
 Fax: (450) 979-4626
www.exmweb.com

Flatness
Aplatissement

Max 3.0mm

Projection

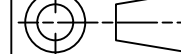

Customer Client	Date
Drawn By / Dessiné Par: BoxCad: Patrick Deschenes	Date: 23-Jan-07
Material / Matière: Polyisocyanurate	
Color / Couleur: Aluminum	Finish / Fini: N/A

Description: 5412ESTH 24" x 16" Right Insulation	Detail Rev.
--	-------------

Part Number / Numéro Pièce: 5412ESTH241608I-RS	Rev. 0	13 / 16
--	--------	---------

SEE BILL OF MATERIAL ON LAST PAGE

This drawing is confidential and must not be reproduced or used without the consent of EXM

Ce dessin est confidentiel et ne doit pas être reproduit ou utilisé sans le consentement de EXM

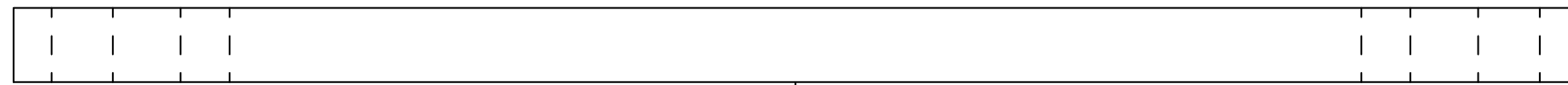

TOP

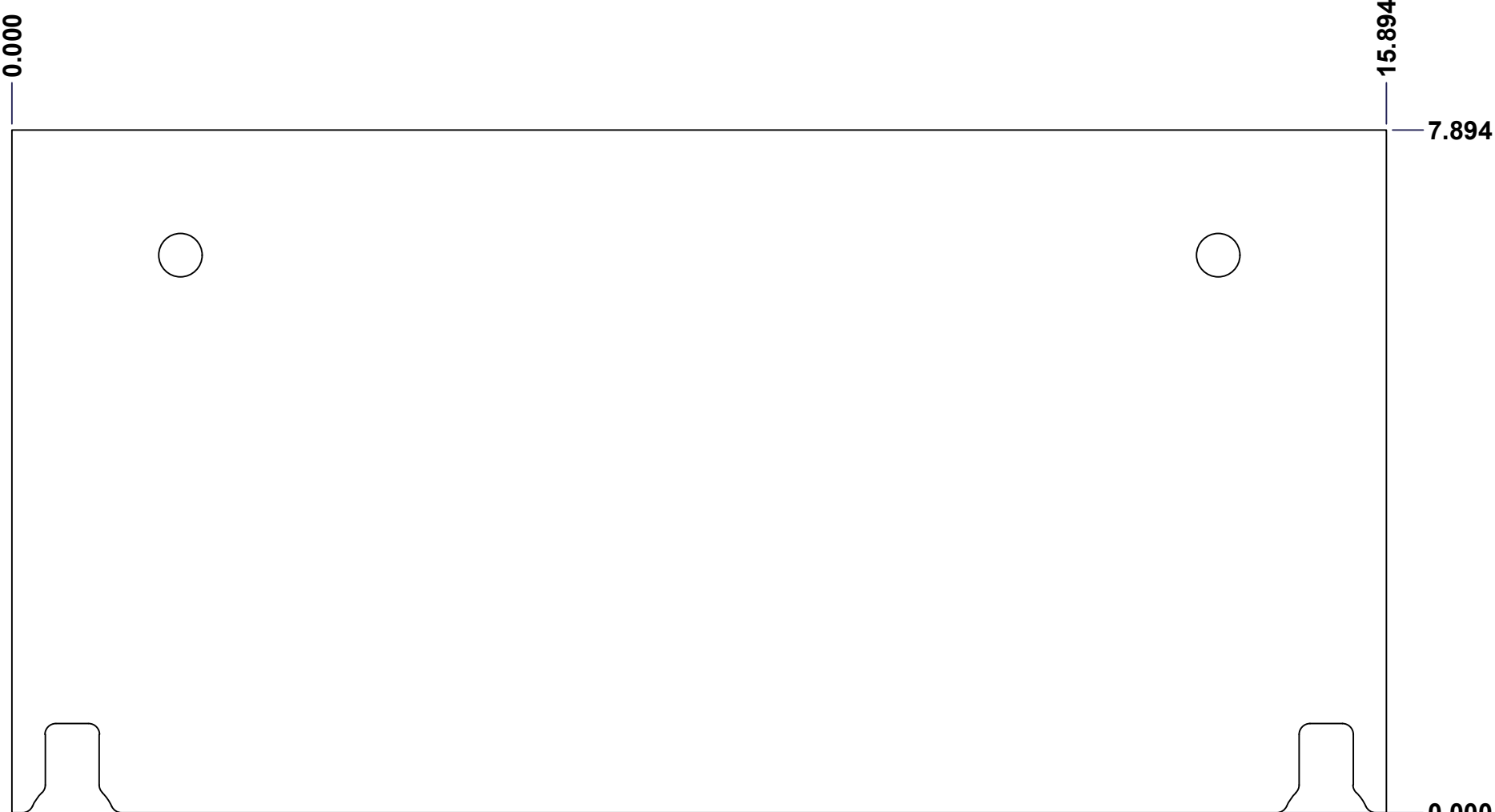

FRONT

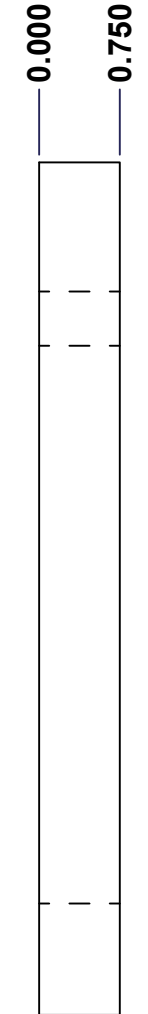

RIGHT

No.	Revisions	Date	By/Par

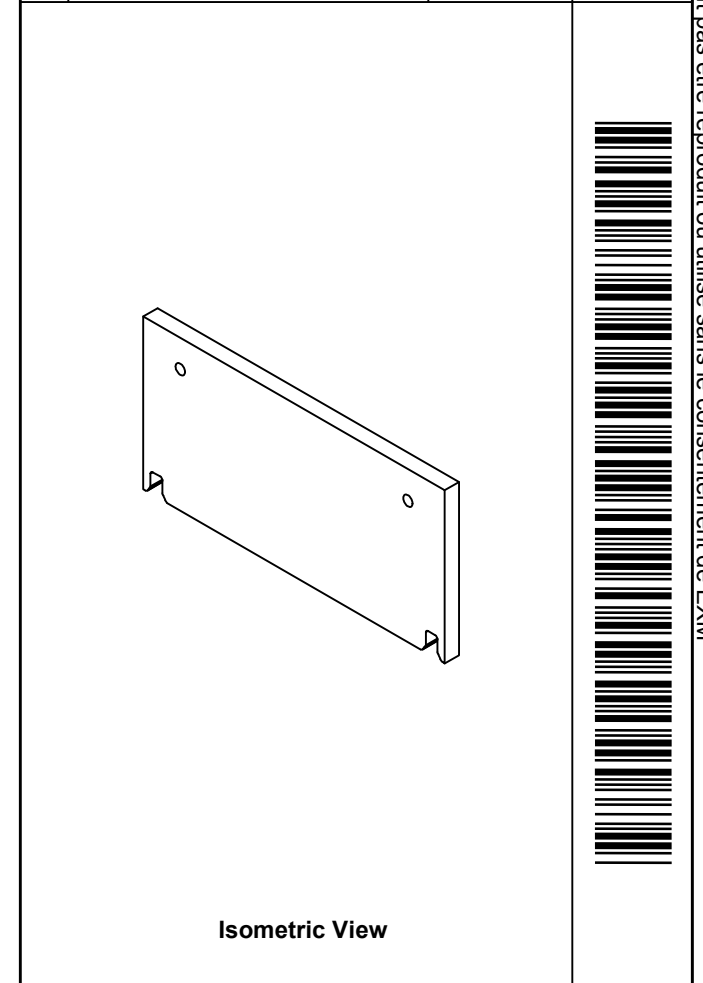

Isometric View

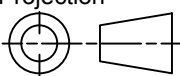
 Tél: (450) 979-4373 Fax: (450) 979-4626 www.exmweb.com		Flatness Aplatissement Max 3.0mm Projection 
Customer Client	Date	
Drawn By Dessiné Par	BoxCad: Patrick Deschenes	Date 23-Jan-07
Material Matière	Polyisocyanurate	
Color Couleur	Aluminum	Finish Fini N/A
Description	Detail Rev.	
5412ESTH 24" x 16" Top and Bottom Insulation		
Part Number Numéro Pièce	Rev.	14
5412ESTH241608I-TP	0	16

SEE BILL OF MATERIAL ON LAST PAGE

This drawing is confidential and must not be reproduced or used without the consent of EXM

Ce dessin est confidentiel et ne doit pas être reproduit ou utilisé sans le consentement de EXM



TOP

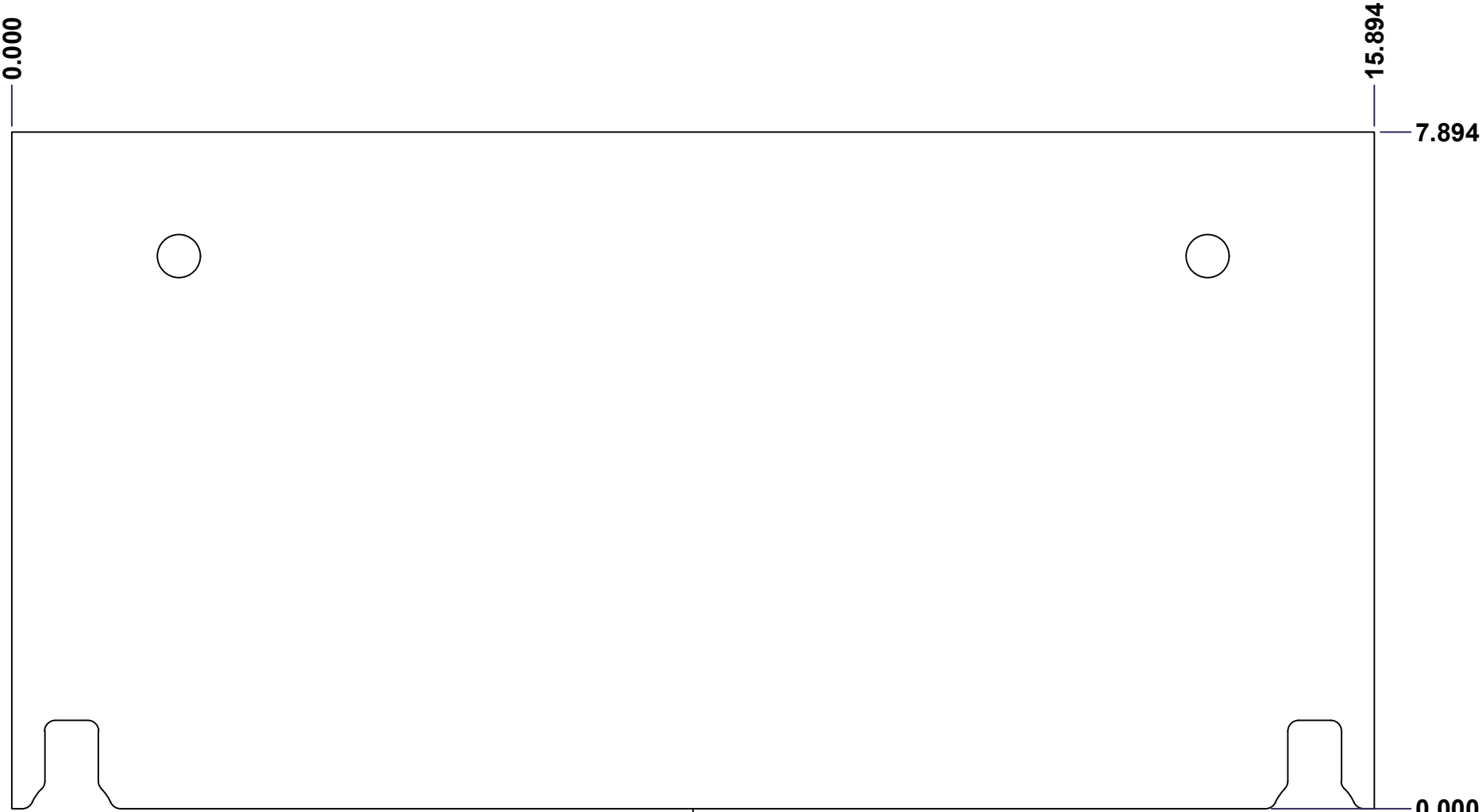

FRONT

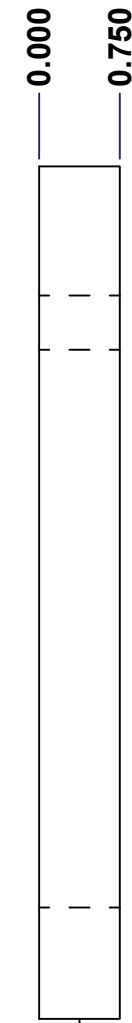

RIGHT

No.	Revisions	Date	By/Par

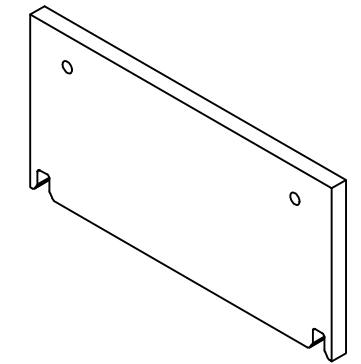

Isometric View

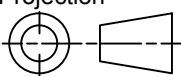

 Tél: (450) 979-4373 Fax: (450) 979-4626 www.exmweb.com	Flatness Aplatissement Max 3.0mm
	Projection 
Customer Client	Date
Drawn By Dessiné Par BoxCad: Patrick Deschenes	Date 23-Jan-07
Material Matière Polyisocyanurate	
Color Couleur Aluminum	Finish Fini N/A
Description 5412ESTH 24" x 16" Top and Bottom Insulation	
Part Number Numéro Pièce 5412ESTH241608I-BT	Detail Rev. Rev. 15 0

SEE BILL OF MATERIAL ON LAST PAGE

This drawing is confidential and must not be reproduced or used without the consent of EXM

Ce dessin est confidentiel et ne doit pas être reproduit ou utilisé sans le consentement de EXM

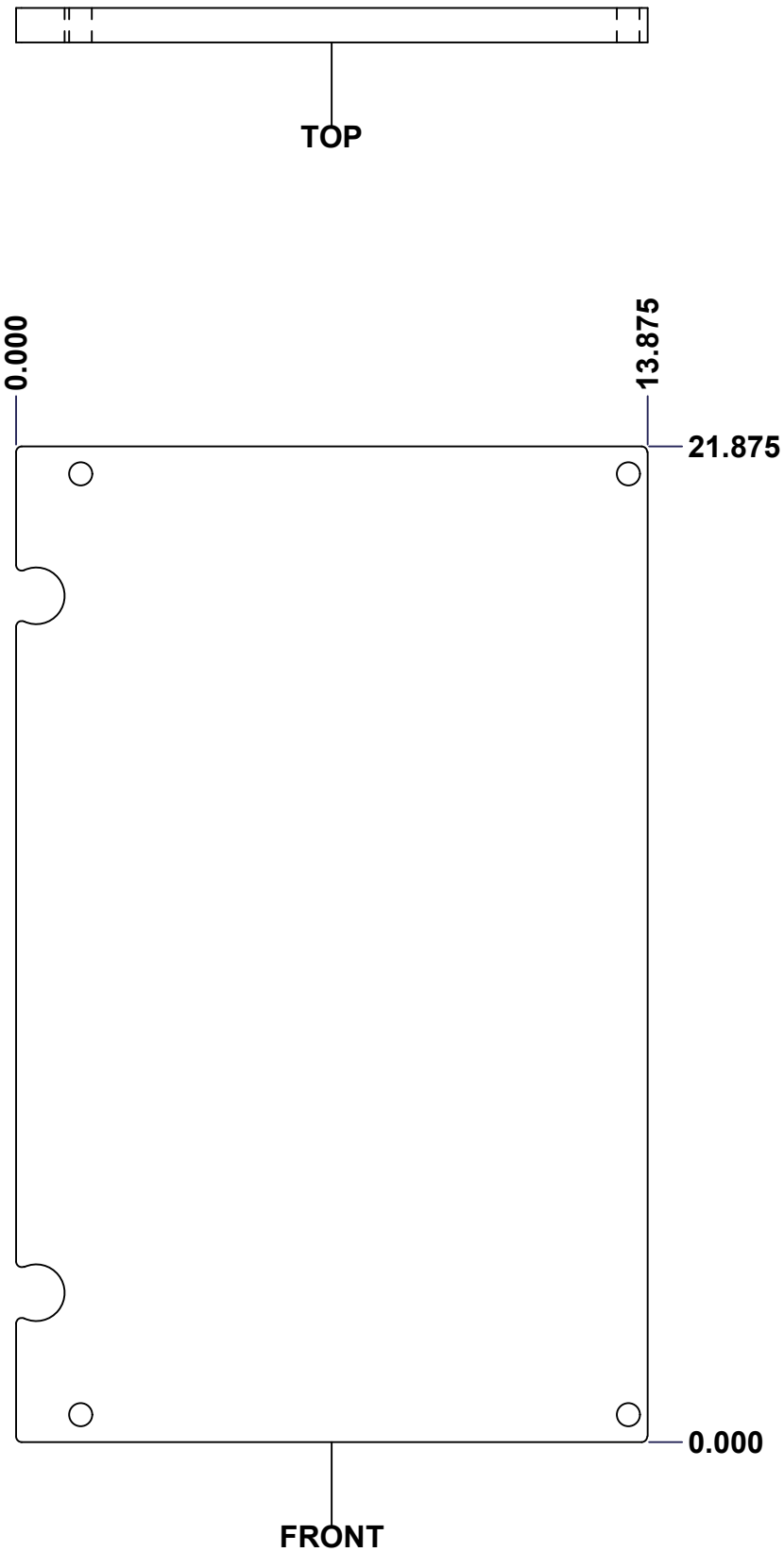

No.	Revisions	Date	By/Par

Isometric View

<p>Tél: (450) 979-4373 Fax: (450) 979-4626 www.exmweb.com</p>		Flatness Aplatissement
		Max 3.0mm
Projection 		Date
Customer Client	BoxCad: Patrick Deschenes	Date 23-Jan-07
Material Matière	Polyisocyanurate	
Color Couleur	Aluminum	Finish Fini N/A
Description 5412ESTH 24" x 16" Cover Insulation		Detail Rev.
Part Number Numéro Pièce	Rev. 0	16 / 16

SEE BILL OF MATERIAL ON LAST PAGE

5412ESTH241608I-C

This drawing is confidential and must not be reproduced or used without the consent of EXM

Ce dessin est confidentiel et ne doit pas être reproduit ou utilisé sans le consentement de EXM

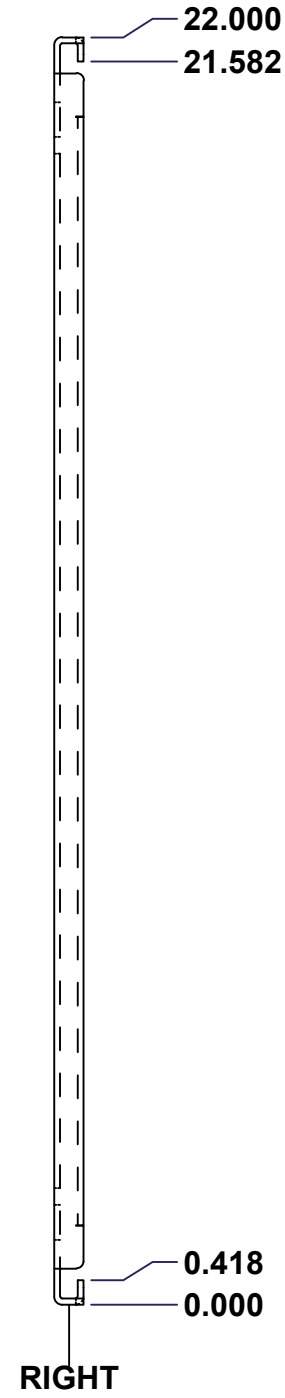
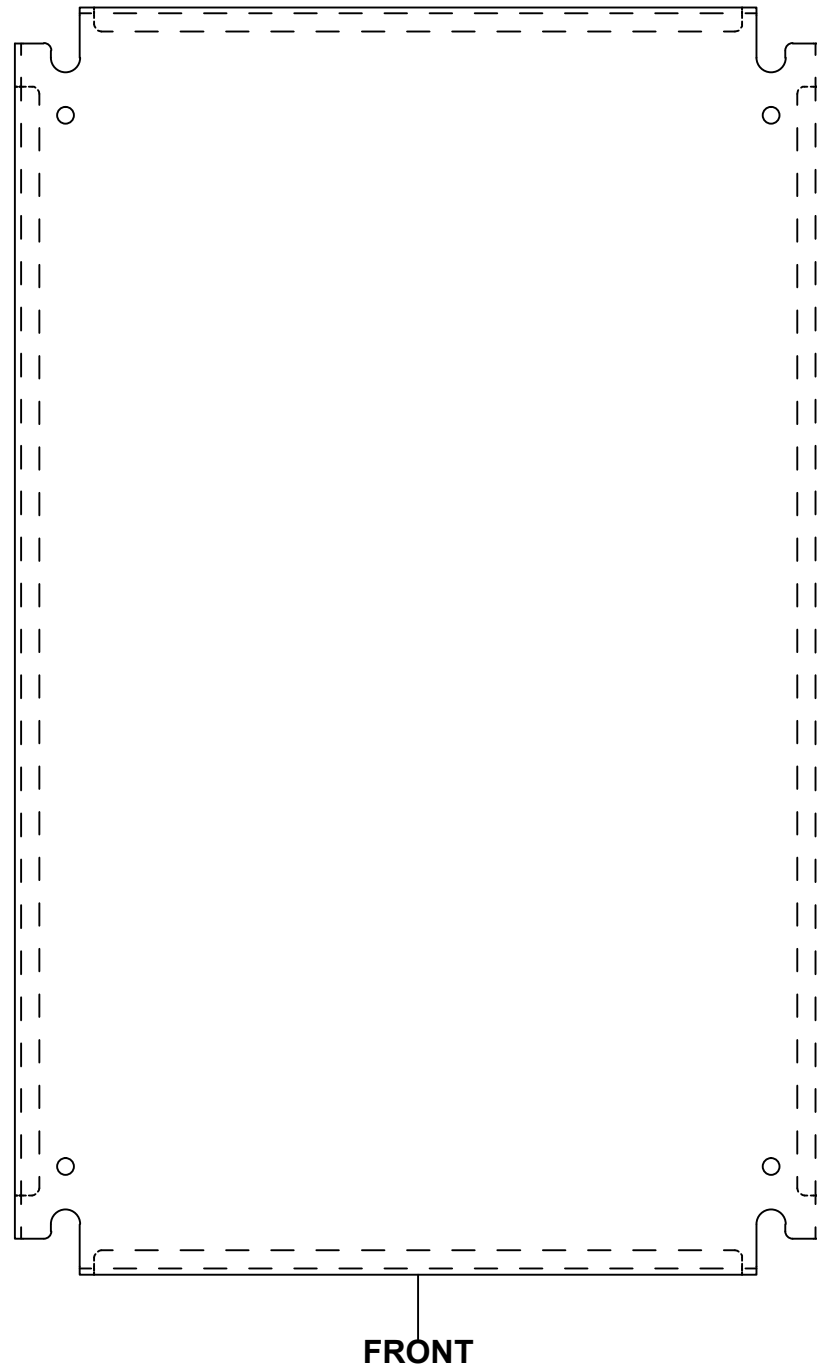
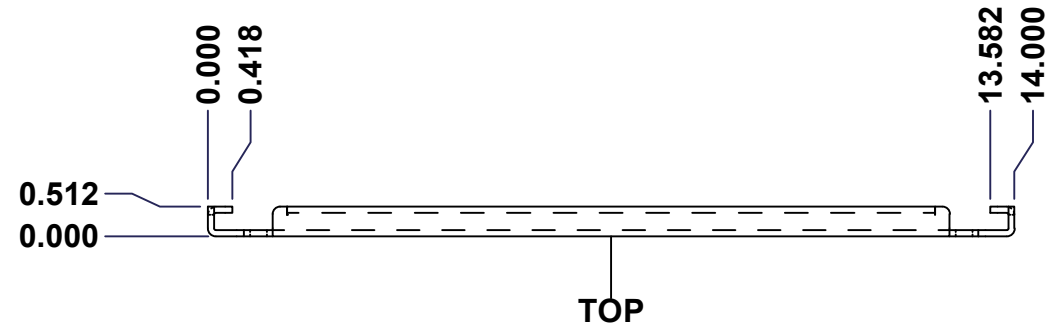

No.	Revisions	Date	By/Par

Isometric View

<p>Tél: (450) 979-4373 Fax: (450) 979-4626 www.exmweb.com</p>	Flatness Aplatissement
	Max 3.0mm
Projection	
Customer Client	Date
Drawn By Dessiné Par BoxCad	Date 23-Jan-07
Material Matière	See Part List
Color Couleur	See Part List
Finish Fini	See Part List
Description	Detail Rev.
881 SP - Inner Panel	
Part Number Numéro Pièce	Rev. 1
881 SP2416G	0 2

Qty	Part Number	Rev	Description	Material	Color	Finish
1	881 SP2416G-P	0	881 SP - Inner Panel Part	12 Ga Galvanized	Unpainted	Galvanized

Parts List

This drawing is confidential and must not be reproduced or used without the consent of EXM

Ce dessin est confidentiel et ne doit pas être reproduit ou utilisé sans le consentement de EXM

Table 1			FRONT VIEW
CUT-OUT	XDIM	YDIM	DESCRIPTION
1	0.875	1.875	GROUND HOLE (RND Ø0.290)
2	13.125	1.875	GROUND HOLE (RND Ø0.290)
3	0.875	20.125	GROUND HOLE (RND Ø0.290)
4	13.125	20.125	GROUND HOLE (RND Ø0.290)

All knockouts are actual size / Les disques défonçables sont grandeur réel

No.	Revisions	Date	By/Par

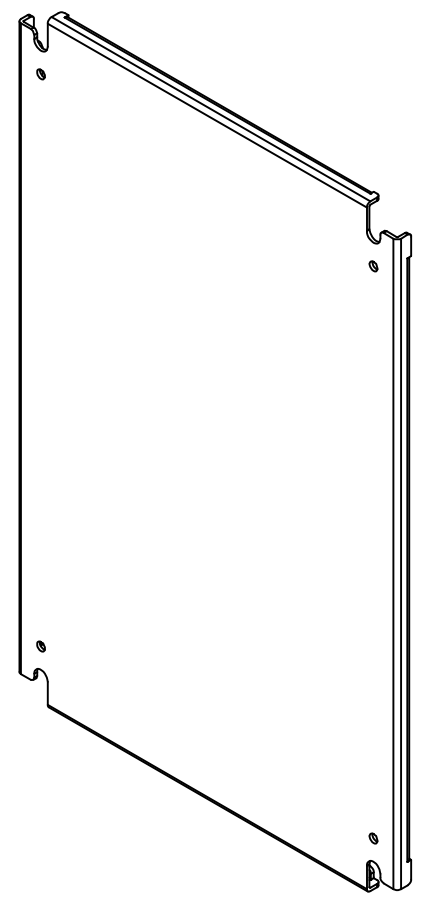
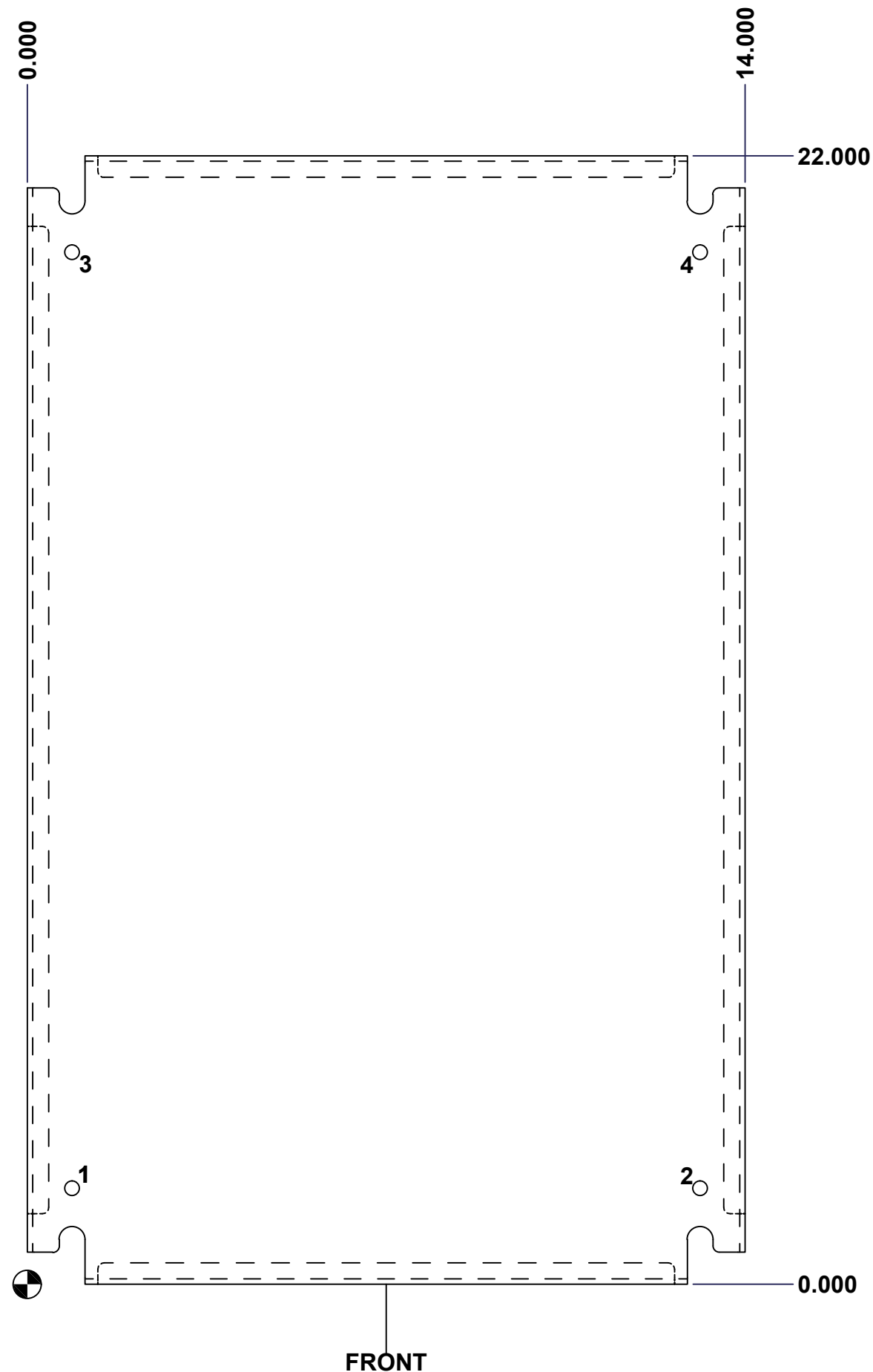

Isometric View



	Tél: (450) 979-4373 Fax: (450) 979-4626 www.exmweb.com	Flatness Aplatissement
		Max 3.0mm Projection
Customer Client		Date
Drawn By Dessiné Par	BoxCad	Date 23-Jan-07
Material Matière	See Part List	
Color Couleur	See Part List	Finish Fini See Part List
Description	881 SP - Inner Panel	
Part Number Numéro Pièce	881 SP2416G	Detail Rev. Rev. 2 0