

This drawing is confidential and must not be reproduced or used without the consent of EXM

Ce dessin est confidentiel et ne doit pas être reproduit ou utilisé sans le consentement de EXM

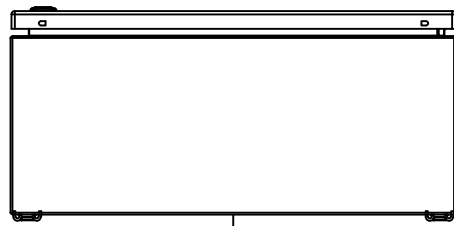

TOP

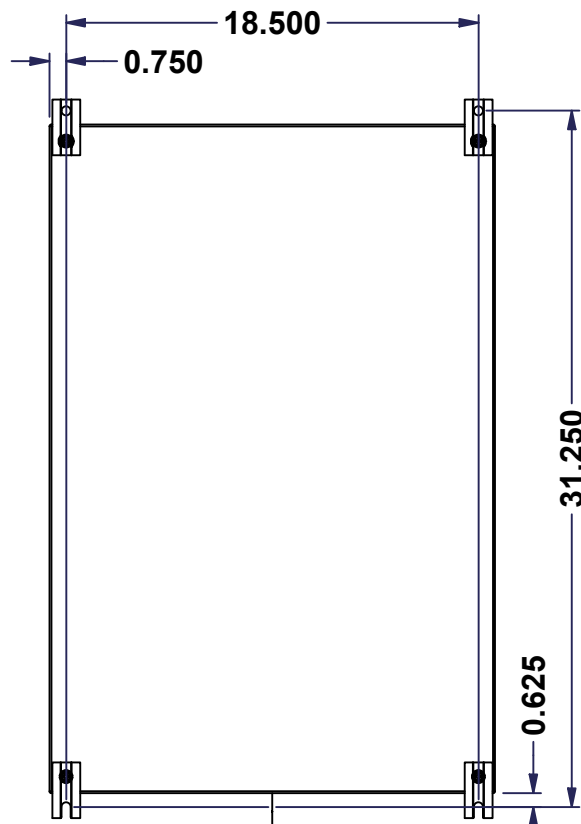

BACK

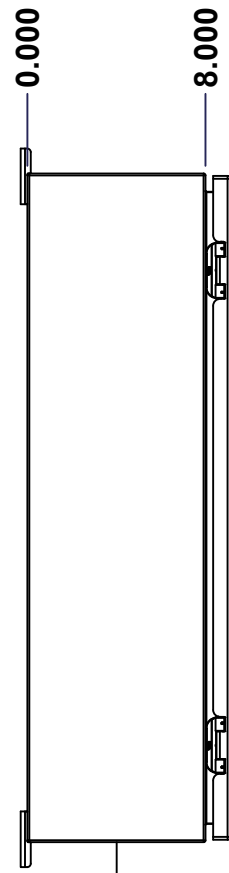

LEFT

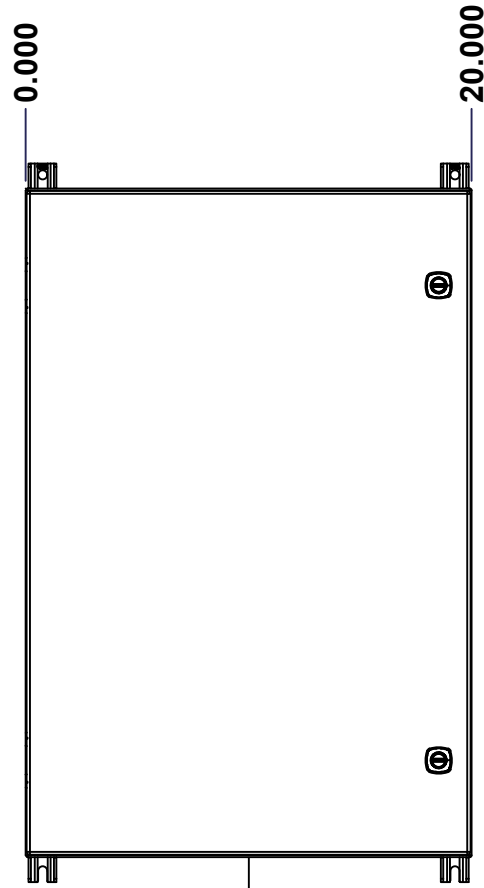

FRONT



RIGHT

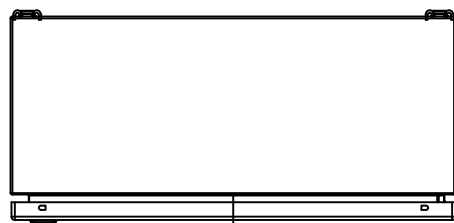

BOTTOM

| No. | Revisions | Date | By/Par |
|-----|-----------|------|--------|
| | | | |
| | | | |
| | | | |
| | | | |

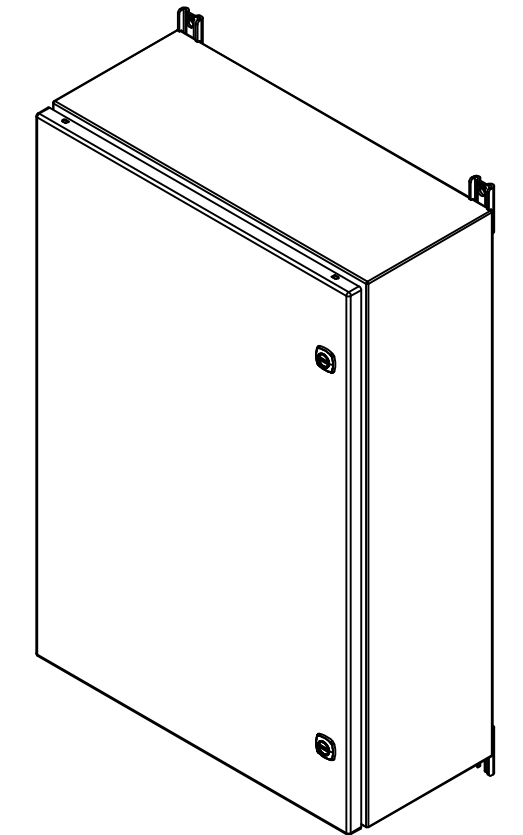

Isometric View

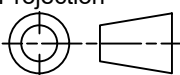

| | | |
|--|---|---|
|  Tél: (450) 979-4373 Fax: (450) 979-4626 www.exmweb.com | | Flatness Aplatissement Max 3.0mm Projection  |
| Customer Client | Date | |
| Drawn By Dessiné Par | BoxCad: BoxCad | Date 14-Mar-14 |
| Material Matière | 16 Ga Cold Rolled A1008 CS Type B (1.4mm) | |
| Color Couleur | Asa-61 Grey | Finish Fini Smooth |
| Description | Detail Rev. | |
| 5412ESTH 30" x 20" x 8" Assembly | | |
| Part Number Numéro Pièce | Rev. | 1 |
| 5412ESTH302008 | 0 | 16 |

SEE BILL OF MATERIAL ON LAST PAGE

This drawing is confidential and must not be reproduced or used without the consent of EXM

Ce dessin est confidentiel et ne doit pas être reproduit ou utilisé sans le consentement de EXM

| NOTE | |
|------|---|
| ITEM | DESCRIPTION |
| 1 | NEMA 4/12 Enclosure |
| 2 | C/W Standard ground studs on box and cover |
| 3 | C/W Standard door stiffener |
| 4 | C/W Standard inner panel (Included) |
| 5 | C/W Standard inner panel mounting studs |
| 6 | C/W 885 ESMF3_OPEN Sold separately (Installed) |
| 7 | C/W 885 ESMF3_CLOSE Sold separately (Installed) |
| 8 | C/W R5 Insulation (Installed by EXM) |

| No. | Revisions | Date | By/Par |
|-----|-----------|------|--------|
| | | | |
| | | | |
| | | | |
| | | | |
| | | | |
| | | | |

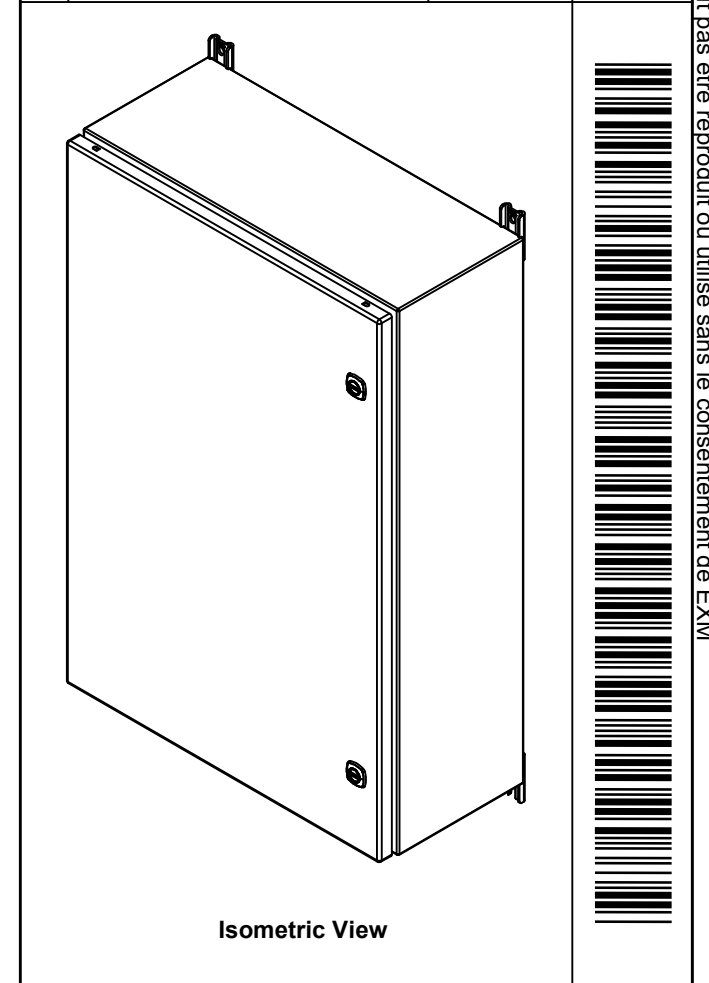

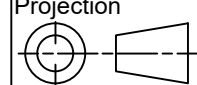
| | |
|--|---|
|  Tél: (450) 979-4373 Fax: (450) 979-4626 www.exmweb.com | Flatness Aplatissement |
| | Max 3.0mm |
| Projection |  |
| Customer Client | Date |
| Drawn By Dessiné Par BoxCad: BoxCad | Date 14-Mar-14 |
| Material Matière 16 Ga Cold Rolled A1008 CS Type B (1.4mm) | |

| PACKING | | |
|-----------------------|-----|--|
| ITEM | QTY | DESCRIPTION |
| Cardboard sleeve | 2 | Top and Bottom |
| Cardboard strip | 2 | Between back of enclosure and inner panel |
| Plastic bag | 1 | To protect cover surface and inside gasket |
| Plastic strap - Black | 2 | To Squeeze the 2 cardboard sleeve together |
| Packaging label | 1 | White label with product number |

| | | | |
|------------|-----------------|-----|--|
| 4 | STK-Q-00600 | 2 | M12 to M8 Adaptor |
| 1 | 881 SP3020G | 0 | 881 SP - Inner Panel |
| 1 | STK-K-01800 | 5 | 5412 ES Accessory Kit |
| 1 | 5412ESTH302008C | 0 | 5412ESTH 30" x 20" Cover |
| 1 | 5412ESTH302008B | 0 | 5412ESTH 30" x 20" x 8" Body |
| 2 | STK-Q-04050-08 | 0 | M6 x 8mm Hexagon Socket Head Machine Screw |
| Qty | Part Number | Rev | Description |
| Parts List | | | |

| | | | |
|-----------------------------|----------------------------------|----------------|--------|
| Color Couleur | Asa-61 Grey | Finish Fini | Smooth |
| Description | 5412ESTH 30" x 20" x 8" Assembly | | |
| Part Number Numéro Pièce | 5412ESTH302008 | | Rev. 2 |
| | | | 0 |
| | | | 16 |

This drawing is confidential and must not be reproduced or used without the consent of EXM

Ce dessin est confidentiel et ne doit pas être reproduit ou utilisé sans le consentement de EXM

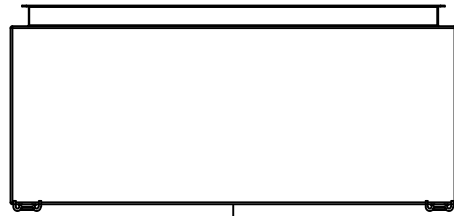

TOP

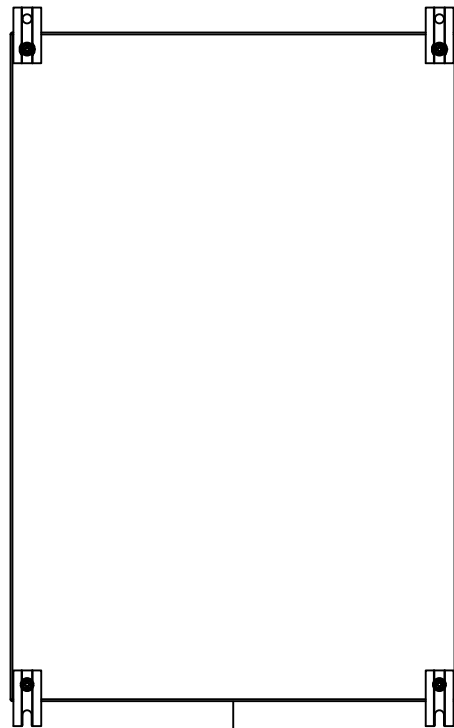

BACK

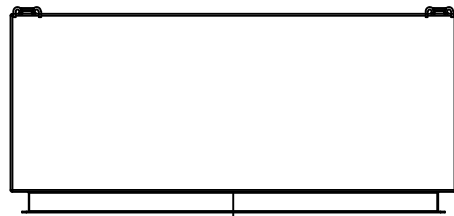

BOTTOM

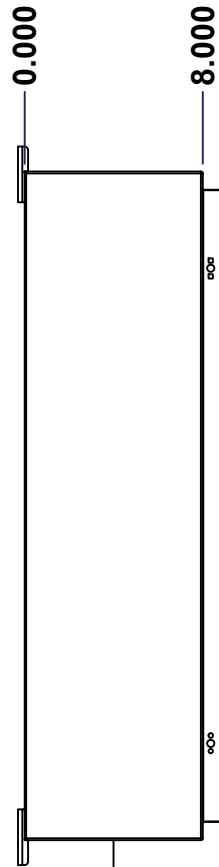

LEFT

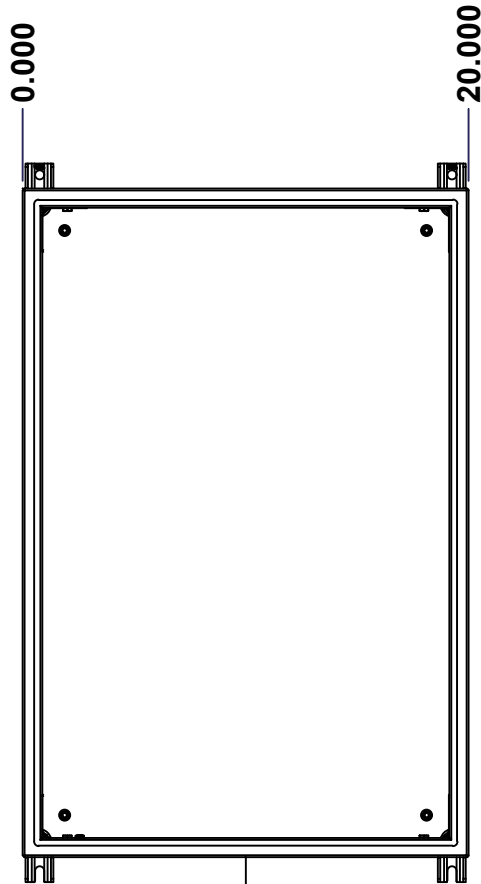

FRONT

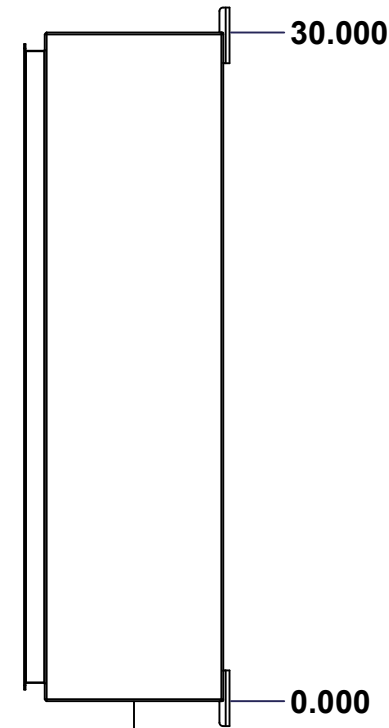

RIGHT

| No. | Revisions | Date | By/Par |
|-----|-----------|------|--------|
| | | | |
| | | | |
| | | | |
| | | | |

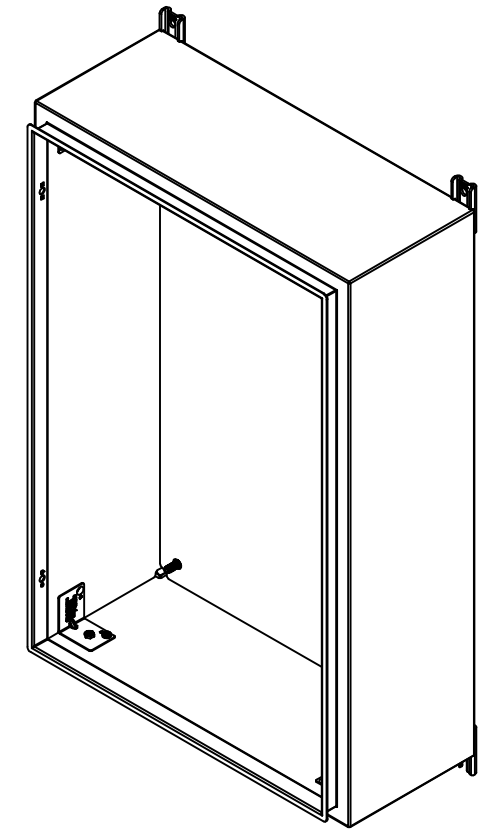

Isometric View



Tél: (450) 979-4373
 Fax: (450) 979-4626
www.exmweb.com

Flatness
Aplatissement

Max 3.0mm

Projection



| | |
|---|-----------------------|
| Customer Client | Date |
| Drawn By / Dessiné Par: BoxCad: BoxCad | Date: 14-Mar-14 |
| Material / Matière: 16 Ga Cold Rolled A1008 CS Type B (1.4mm) | |
| Color / Couleur: Asa-61 Grey | Finish / Fini: Smooth |
| Description: 5412ESTH 30" x 20" x 8" Body | Detail Rev. |
| Part Number / Numéro Pièce: 5412ESTH302008B | Rev. 3 |
| SEE BILL OF MATERIAL ON LAST PAGE | 0 |

This drawing is confidential and must not be reproduced or used without the consent of EXM

Ce dessin est confidentiel et ne doit pas être reproduit ou utilisé sans le consentement de EXM

| STANDARD FEATURES ARE NOT LISTED IN THIS HOLE TABLE | | | |
|--|--------|-------|--------------------------------|
| HOLE TABLE - TOP VIEW (CUSTOM FEATURE ONLY) | | | |
| CUT-OUT | XDIM | YDIM | DESCRIPTION |
| 1 | 2.000 | 6.500 | INSUL. STUD M6 x 18mm (Inside) |
| 2 | 18.000 | 6.500 | INSUL. STUD M6 x 18mm (Inside) |

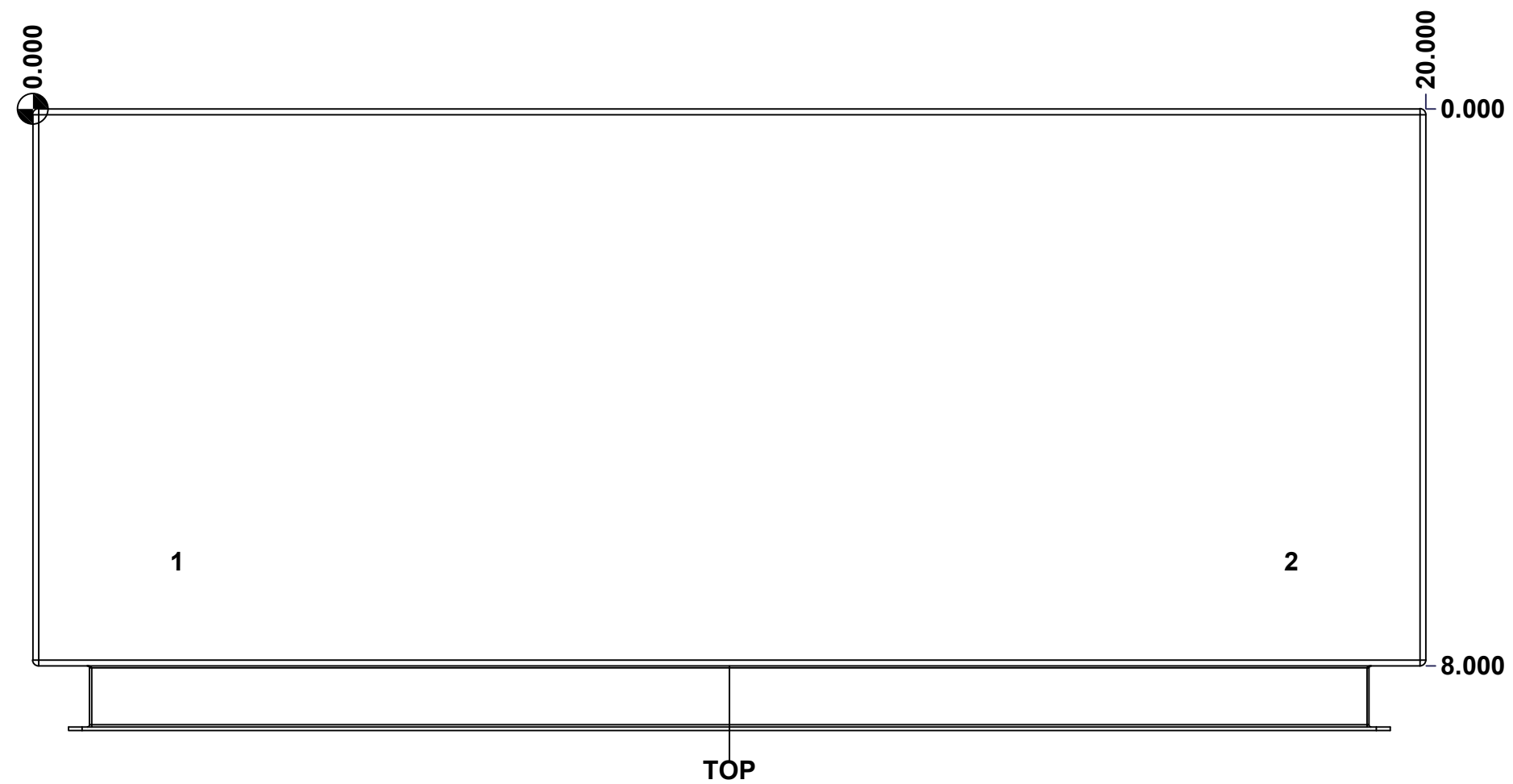

| | | |
|--|------------------------------|--------------|
| | Description | Status |
| | 5412ESTH 30" x 20" x 8" Body | (NULL) |
| | Part Number Numéro Pièce | Rev. |
| | 5412ESTH302008B | 0 / 4 |
| | | 16 |

This drawing is confidential and must not be reproduced or used without the consent of EXM

Ce dessin est confidentiel et ne doit pas être reproduit ou utilisé sans le consentement de EXM

| STANDARD FEATURES ARE NOT LISTED IN THIS HOLE TABLE | | | |
|--|--------|-------|--------------------------------|
| HOLE TABLE - BOTTOM VIEW (CUSTOM FEATURE ONLY) | | | |
| CUT-OUT | XDIM | YDIM | DESCRIPTION |
| 1 | 2.000 | 6.500 | INSUL. STUD M6 x 18mm (Inside) |
| 2 | 18.000 | 6.500 | INSUL. STUD M6 x 18mm (Inside) |

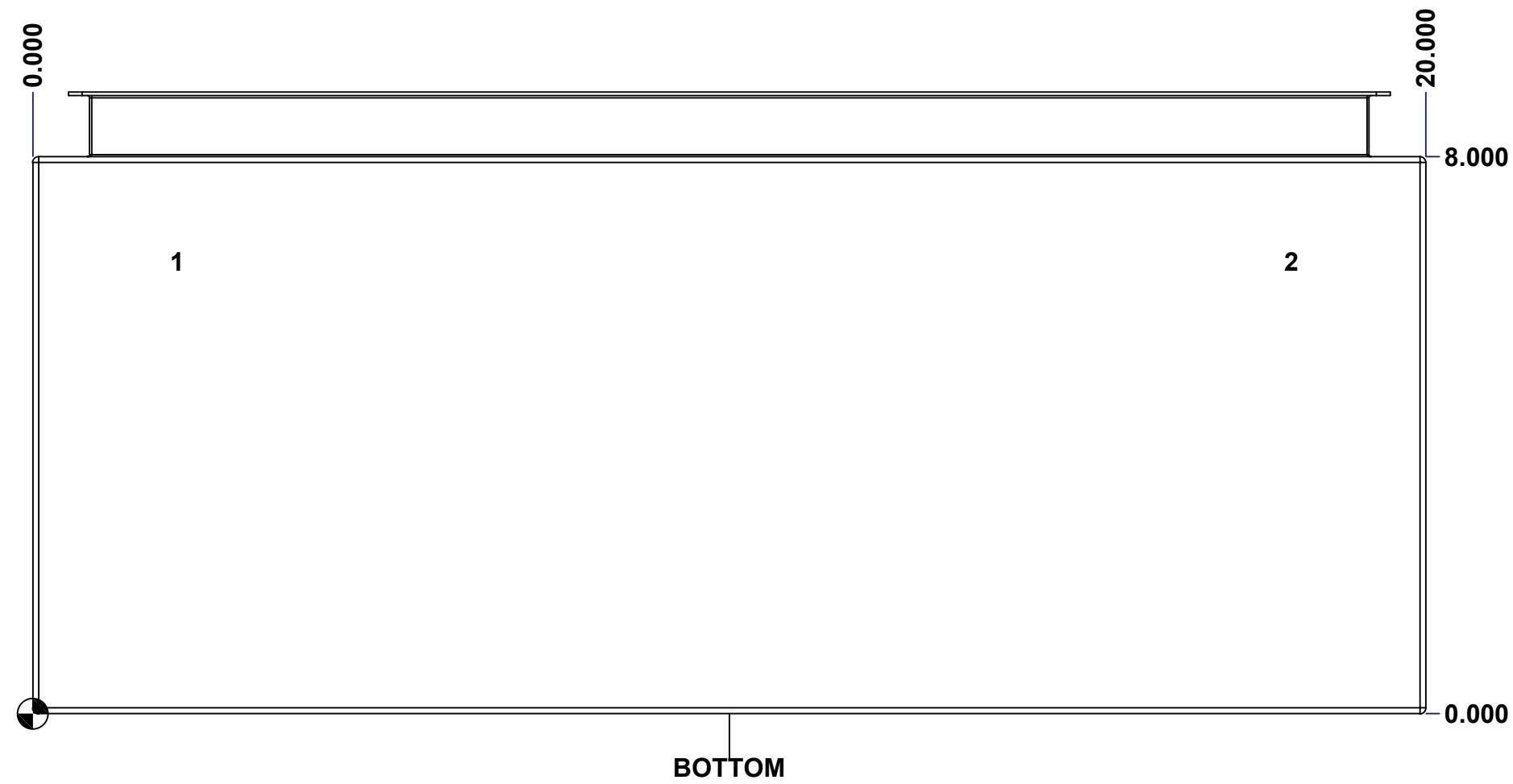

| | | | |
|--|------------------------------|----------|---------|
| | Description | Status | |
| | 5412ESTH 30" x 20" x 8" Body | (NULL) | |
| | Part Number Numéro Pièce | Rev. | |
| | 5412ESTH302008B | 0 | 5 16 |

This drawing is confidential and must not be reproduced or used without the consent of EXM

Ce dessin est confidentiel et ne doit pas être reproduit ou utilisé sans le consentement de EXM

STANDARD FEATURES ARE NOT LISTED IN THIS HOLE TABLE

HOLE TABLE - BACK VIEW (CUSTOM FEATURE ONLY)

| CUT-OUT | XDIM | YDIM | DESCRIPTION |
|---------|--------|--------|----------------------------|
| 1 | 1.875 | 1.875 | IP STUD M8 x 35mm (Inside) |
| 2 | 1.875 | 28.125 | IP STUD M8 x 35mm (Inside) |
| 3 | 18.125 | 28.125 | IP STUD M8 x 35mm (Inside) |
| 4 | 18.125 | 1.875 | IP STUD M8 x 35mm (Inside) |
| ----- | | | |
| 5 | 19.250 | 0.000 | FOOT 885 ESMF3_OPEN |
| 6 | 0.750 | 0.000 | FOOT 885 ESMF3_OPEN |
| 7 | 19.250 | 30.000 | FOOT 885 ESMF3_CLOSE |
| 8 | 0.750 | 30.000 | FOOT 885 ESMF3_CLOSE |

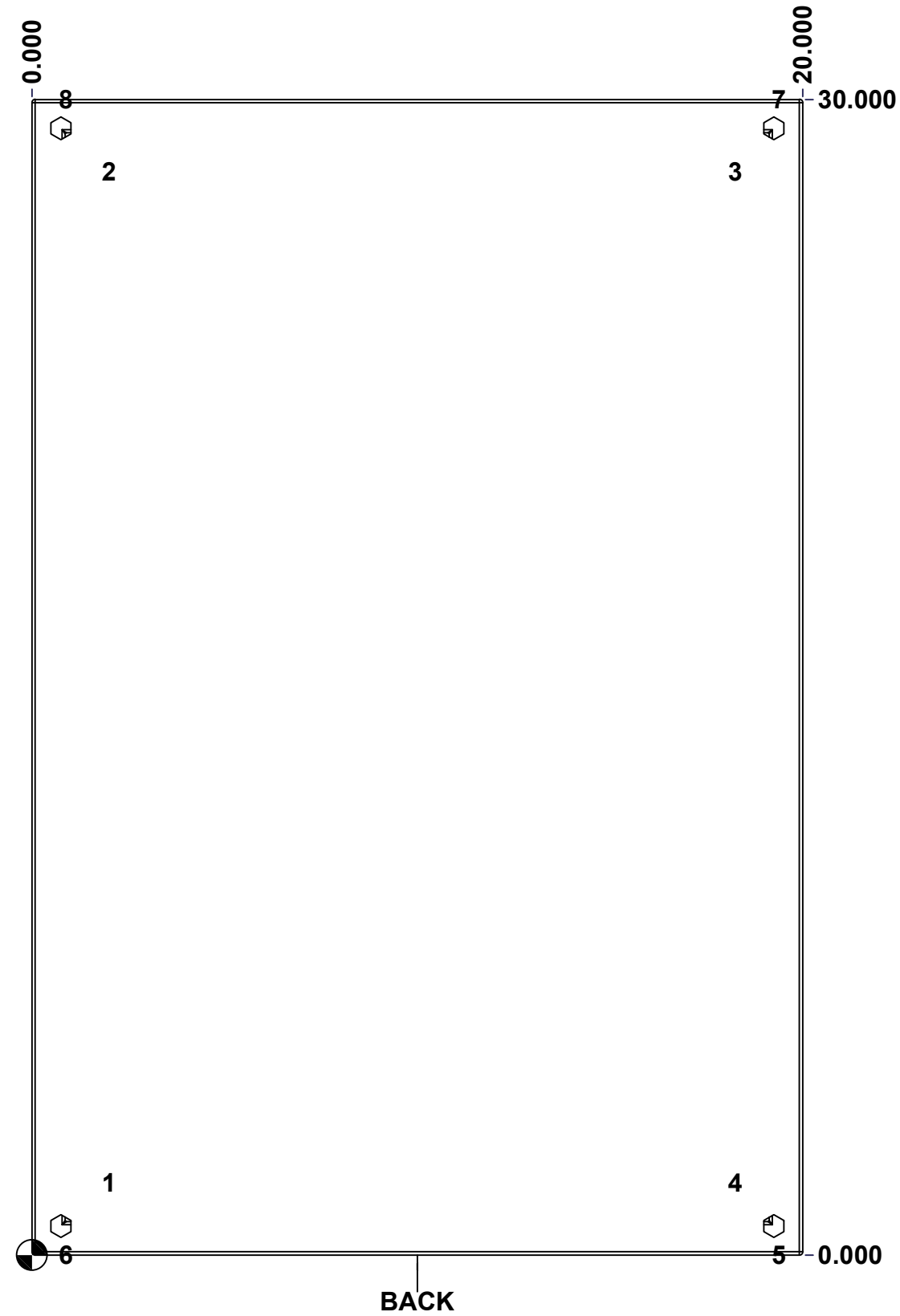

| | | |
|--|------------------------------|--------------|
| | Description | Status |
| | 5412ESTH 30" x 20" x 8" Body | (NULL) |
| | Part Number Numéro Pièce | Rev. |
| | 5412ESTH302008B | 0 / 6 |
| | | 16 |

This drawing is confidential and must not be reproduced or used without the consent of EXM

Ce dessin est confidentiel et ne doit pas être reproduit ou utilisé sans le consentement de EXM

| No. | Revisions | Date | By/Par |
|-----|-----------|------|--------|
| | | | |
| | | | |
| | | | |
| | | | |
| | | | |

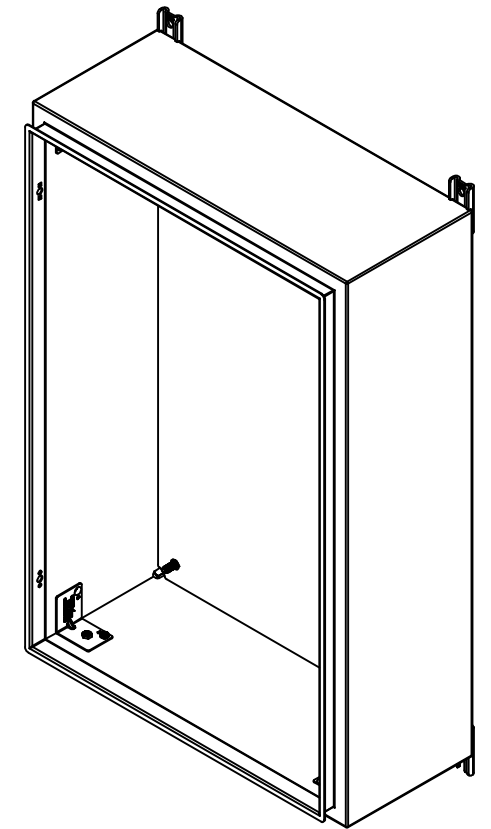

Isometric View



| | | | |
|---|---------------------|---|--|
| 2 | 885ESMF3-FEET | 0 | 885 ESMF3 Mounting Foot |
| 4 | RIVET_NUT_M10_FH_CE | 0 | Rivet Nut M10 (Low Profile Close End) |
| 4 | STK-Q-06660 | 2 | M10 x 16mm Machine Screw |
| 2 | 885ESMF3-FEET-A | 0 | 885 ESMF3 Mounting Foot (Opened Slot) |
| 1 | STK-K-70554 | 3 | 5412 ESTH Accessory Kit |
| 1 | 5412ESTH302008I-RS | 0 | 5412ESTH 30" x 20" Right Insulation |
| 1 | 5412ESTH302008I-LS | 0 | 5412ESTH 30" x 20" Left Insulation |
| 1 | 5412ESTH302008I-BT | 0 | 5412ESTH 30" x 20" Top and Bottom Insulation |
| 1 | 5412ESTH302008I-TP | 0 | 5412ESTH 30" x 20" Top and Bottom Insulation |
| 1 | 5412ESTH302008I-B | 0 | 5412ESTH 30" x 20" Back Insulation |
| 4 | STK-Q-16055 | 1 | M6 x 18mm Stud (No Paint Cap Required) |
| 1 | STK-P-02400S | 0 | Powder Paint (Asa-61 Grey / Smooth) |
| 4 | STK-Q-16005 | 1 | Stud M8 x 35 (No Paint Cap Required) |
| 1 | 5412ESTH302008B-P | 0 | 5412ESTH 30" x 20" x 8" Body Part |

| Qty | Part Number | Rev | Description |
|------------|-------------|-----|-------------|
| Parts List | | | |

| | | | |
|---|--|--|-----------|
| | Tél: (450) 979-4373 Fax: (450) 979-4626 www.exmweb.com | Flatness Aplatissement Max 3.0mm | |
| | Projection | Customer Client | Date |
| Drawn By Dessiné Par | BoxCad: BoxCad | Date | 14-Mar-14 |
| Material Matière | 16 Ga Cold Rolled A1008 CS Type B (1.4mm) | | |
| Color Couleur | Asa-61 Grey | Finish Fini | Smooth |
| Description 5412ESTH 30" x 20" x 8" Body | | Detail Rev. | |
| Part Number Numéro Pièce | 5412ESTH302008B | Rev. | 7 16 |

This drawing is confidential and must not be reproduced or used without the consent of EXM

Ce dessin est confidentiel et ne doit pas être reproduit ou utilisé sans le consentement de EXM

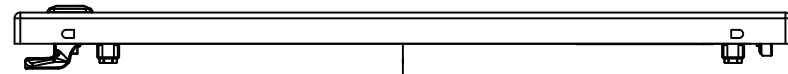

TOP

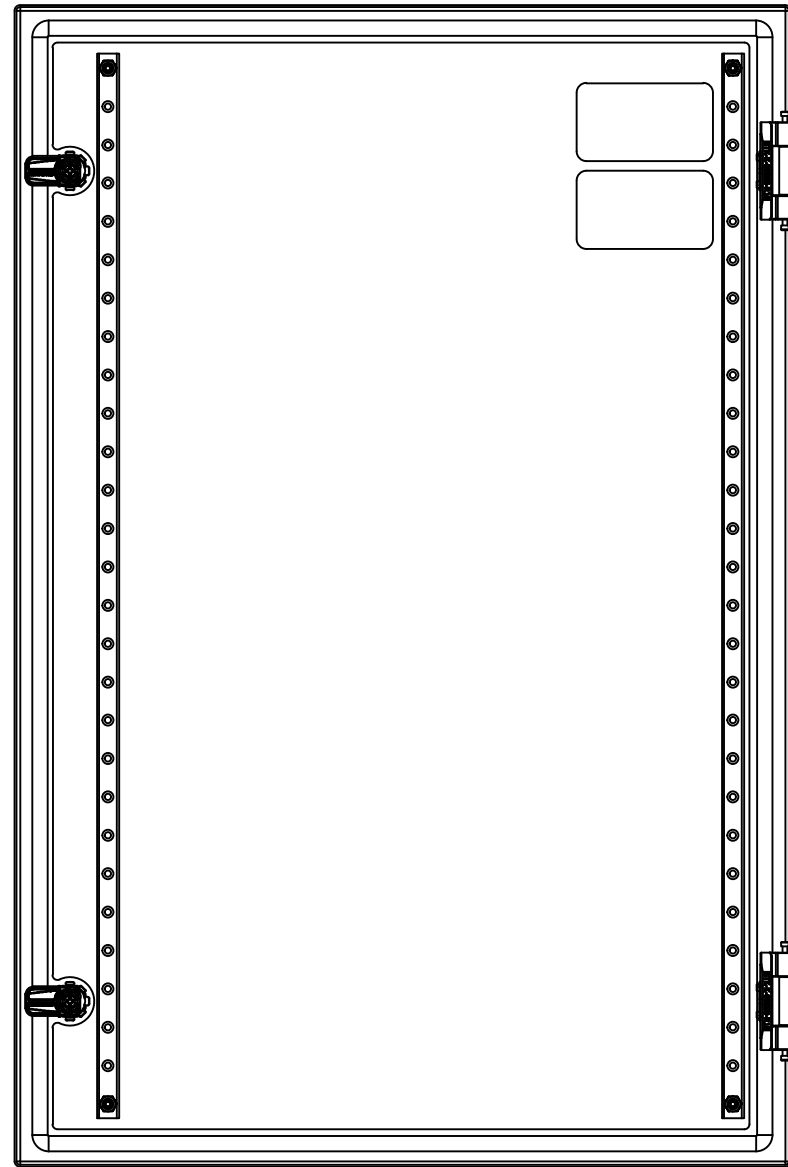

BACK

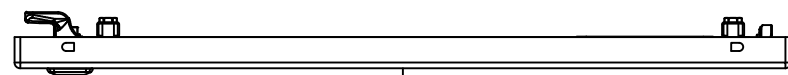

BOTTOM

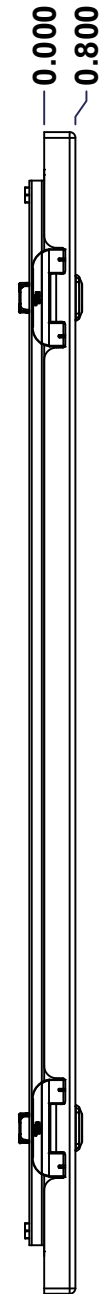

LEFT

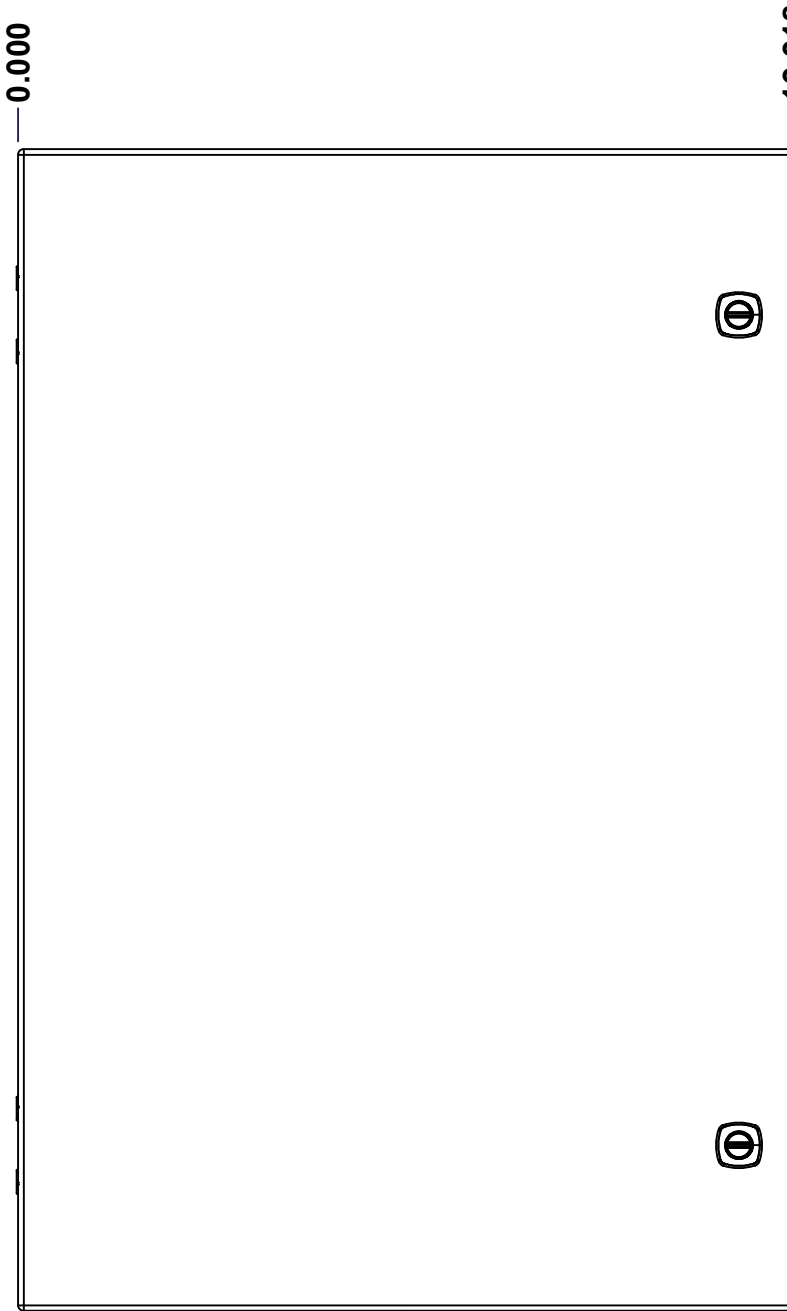

FRONT

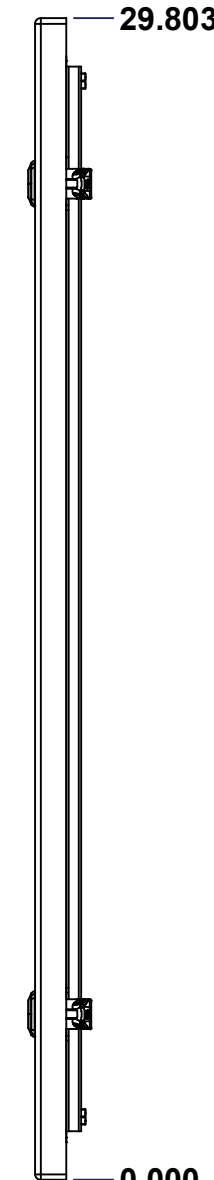

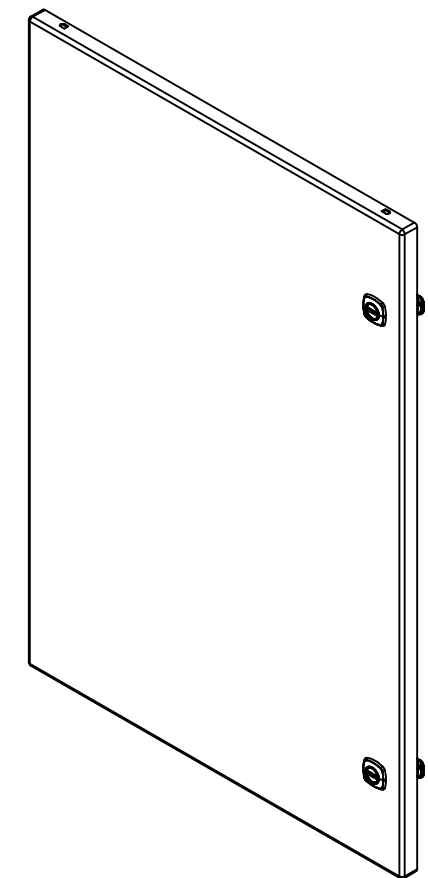

RIGHT



Isometric View

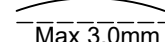

| No. | Revisions | Date | By/Par |
|-----|-----------|------|--------|
| | | | |
| | | | |
| | | | |
| | | | |

| | | |
|--|---|--|
|  Tél: (450) 979-4373 Fax: (450) 979-4626 www.exmweb.com | | Flatness Aplatissement  Max 3.0mm Projection  |
| Customer Client | Date | |
| Drawn By Dessiné Par | BoxCad: BoxCad | Date 14-Mar-14 |
| Material Matière | 16 Ga Cold Rolled A1008 CS Type B (1.4mm) | |
| Color Couleur | Asa-61 Grey | Finish Fini Smooth |
| Description 5412ESTH 30" x 20" Cover | | Detail Rev. |
| Part Number Numéro Pièce | Rev. 0 | 8 / 16 |

SEE BILL OF MATERIAL ON LAST PAGE

5412ESTH302008C

This drawing is confidential and must not be reproduced or used without the consent of EXM

Ce dessin est confidentiel et ne doit pas être reproduit ou utilisé sans le consentement de EXM

STANDARD FEATURES ARE NOT LISTED IN THIS HOLE TABLE

HOLE TABLE - FRONT VIEW (CUSTOM FEATURE ONLY)

| CUT-OUT | XDIM | YDIM | DESCRIPTION |
|---------|--------|--------|-------------------------|
| 1 | 1.486 | 1.614 | STUD M6 x 18mm (Inside) |
| 2 | 1.486 | 28.189 | STUD M6 x 18mm (Inside) |
| 3 | 17.517 | 28.189 | STUD M6 x 18mm (Inside) |
| 4 | 17.517 | 1.614 | STUD M6 x 18mm (Inside) |
| ----- | | | |
| 5 | 18.494 | 4.250 | 880 SCQ4-SL |
| 6 | 18.494 | 25.553 | 880 SCQ4-SL |

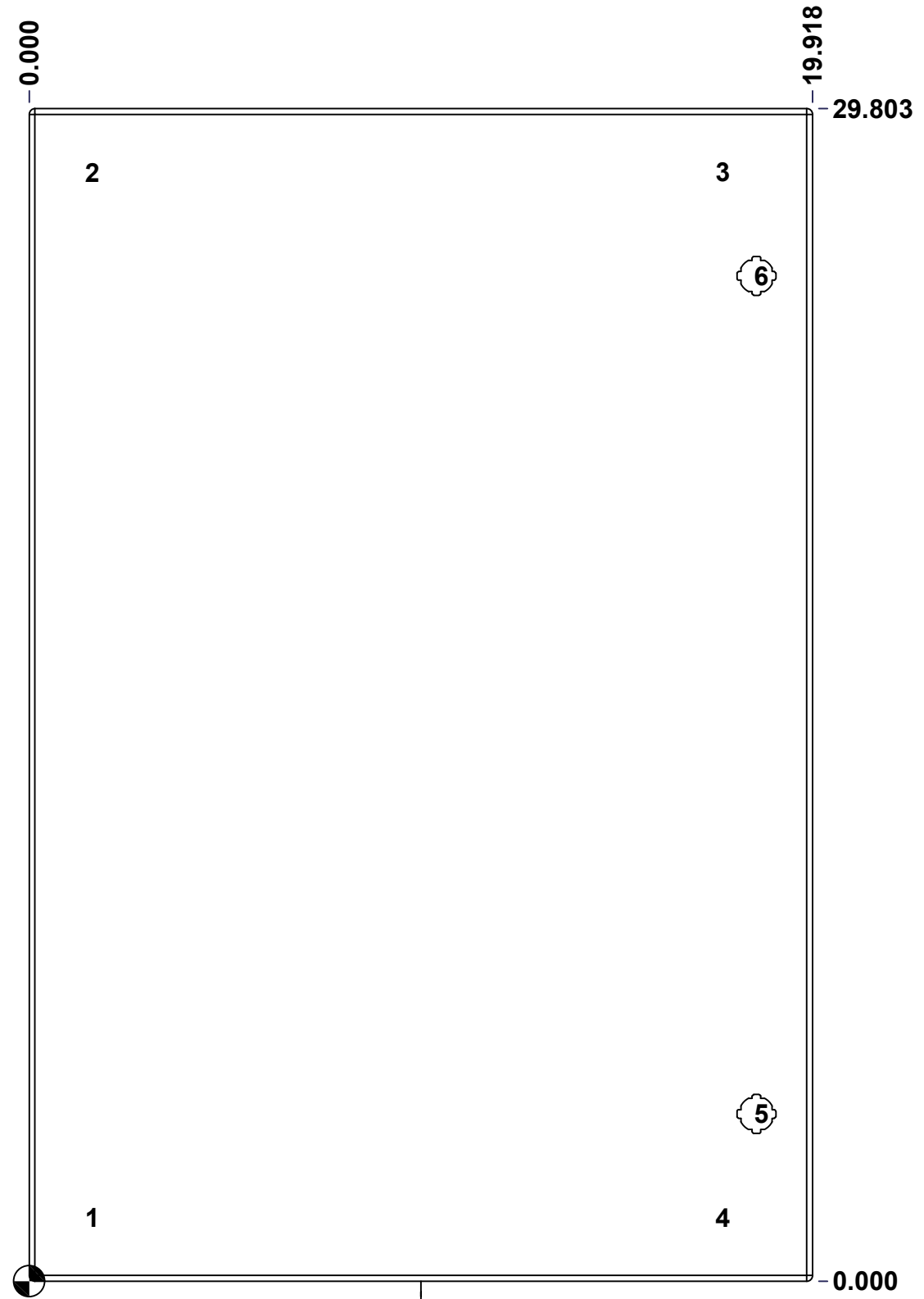

FRONT

| | | |
|--|-----------------------------|--------------|
| | Description | Status |
| | 5412ESTH 30" x 20" Cover | (NULL) |
| | Part Number Numéro Pièce | Rev. |
| | 5412ESTH302008C | 0 / 9 |
| | | 16 |

This drawing is confidential and must not be reproduced or used without the consent of EXM

Ce dessin est confidentiel et ne doit pas être reproduit ou utilisé sans le consentement de EXM

| No. | Revisions | Date | By/Par |
|-----|-----------|------|--------|
| | | | |
| | | | |
| | | | |
| | | | |
| | | | |

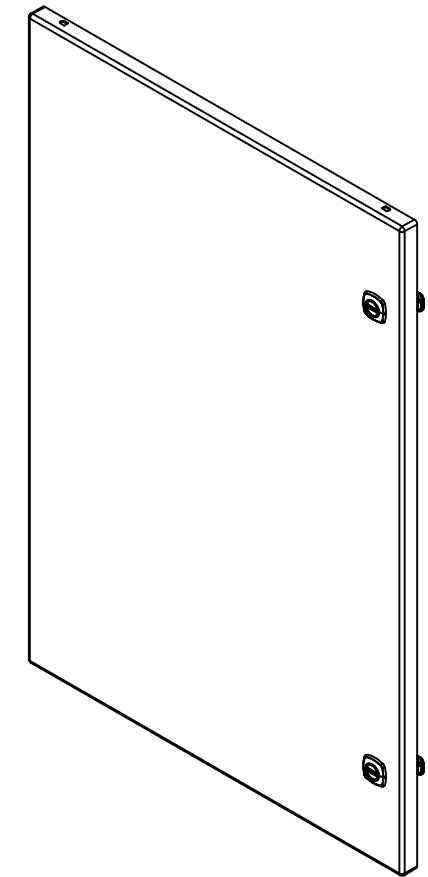

Isometric View



| | |
|--|---|
|  Tél: (450) 979-4373 Fax: (450) 979-4626 www.exmweb.com | Flatness Aplatissement |
| | Max 3.0mm |
| | Projection |
| |  |

| | | | |
|------------|-------------------|-----|---|
| 2 | STK-S-00100 | 0 | 3.5" x 2" Silver Milar Flexcon Sticker |
| 4 | STK-Q-07250 | 2 | M6 x 16mm Collar Nut |
| 2 | STK-Q-46020-30 | 5 | 5412 ES Vertical Door Stiffener 30" |
| 1 | 5412ESTH302008I-C | 0 | 5412ESTH 30" x 20" Cover Insulation |
| 1 | STK-P-02400S | 0 | Powder Paint (Asa-61 Grey / Smooth) |
| 4 | STK-Q-16055 | 1 | M6 x 18mm Stud (No Paint Cap Required) |
| 1 | 5412ESTH302008G | 0 | 5412ESTH 30" x 20" Cover Gasket Part |
| 1 | 5412ESTH302008C-P | 0 | 5412ESTH 30" x 20" Cover Part |
| 2 | STK-K-09800 | 10 | 5412 ES Hinge with 2 Captive Hinge Pins |
| 2 | STK-K-12500 | 16 | 5412 ES 1/4 Turn Lock |
| QTY | Part Number | Rev | Description |
| Parts List | | | |

| | |
|-----------------------------|---|
| Customer Client | Date |
| Drawn By Dessiné Par | Date 14-Mar-14 |
| Material Matière | BoxCad: BoxCad |
| Color Couleur | 16 Ga Cold Rolled A1008 CS Type B (1.4mm) |
| Asa-61 Grey | Finish Fini |
| Smooth | Description |
| 5412ESTH 30" x 20" Cover | Detail Rev. |
| Part Number Numéro Pièce | Rev. 10 |
| 5412ESTH302008C | 0 16 |

This drawing is confidential and must not be reproduced or used without the consent of EXM

Ce dessin est confidentiel et ne doit pas être reproduit ou utilisé sans le consentement de EXM

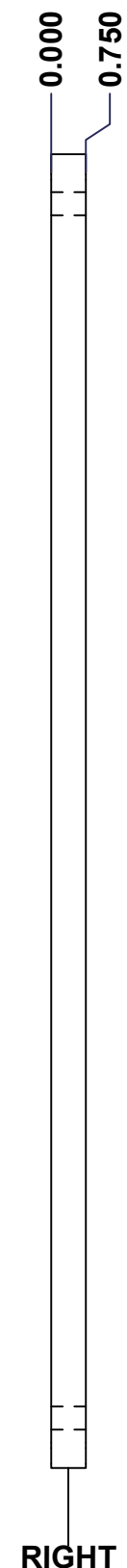
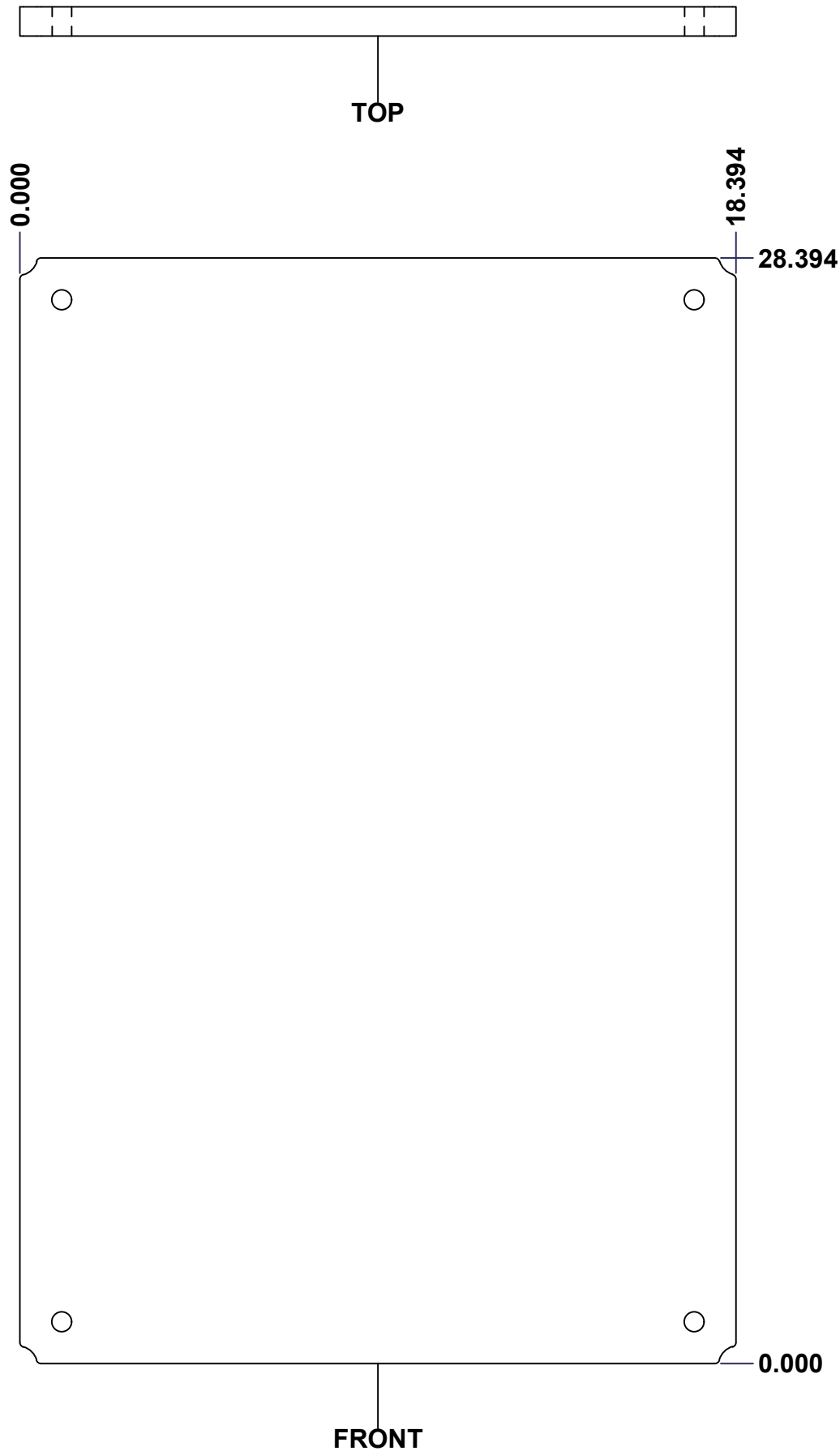

| No. | Revisions | Date | By/Par |
|-----|-----------|------|--------|
| | | | |
| | | | |
| | | | |
| | | | |
| | | | |

Isometric View

| | | | |
|---|--|---------------------------|----------------|
| <p>Tél: (450) 979-4373 Fax: (450) 979-4626 www.exmweb.com</p> | | Flatness Aplatissement | |
| | | Max 3.0mm | |
| Customer Client | | Date | |
| Drawn By Dessiné Par | | Date | |
| Material Matière | | Polyisocyanurate | |
| Color Couleur | | Aluminum | Finish Fini |
| Description | | Detail Rev. | |
| Part Number Numéro Pièce | | Rev. | 11 |
| 5412ESTH302008I-B | | 0 | 16 |

SEE BILL OF MATERIAL ON LAST PAGE

This drawing is confidential and must not be reproduced or used without the consent of EXM

Ce dessin est confidentiel et ne doit pas être reproduit ou utilisé sans le consentement de EXM

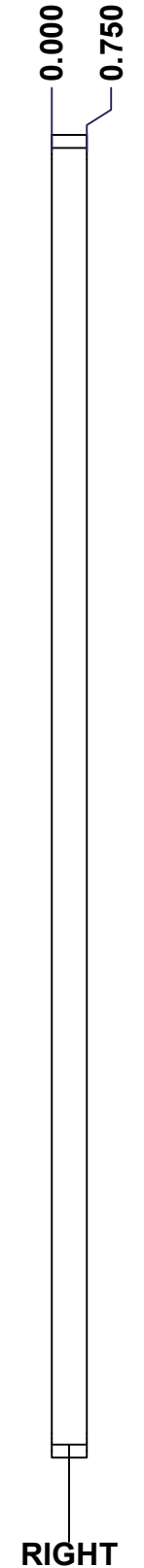

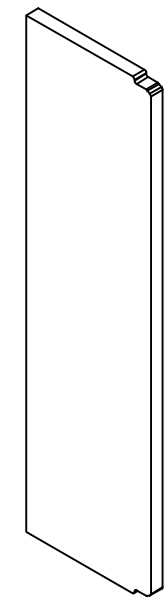

SEE BILL OF MATERIAL ON LAST PAGE

| No. | Revisions | Date | By/Par |
|-----|-----------|------|--------|
| | | | |
| | | | |
| | | | |
| | | | |
| | | | |

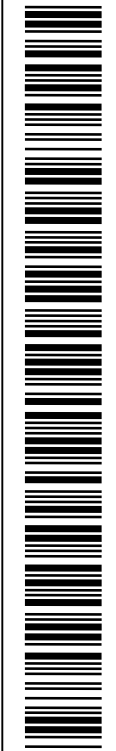

Isometric View



| | | | |
|--|----------|---------------------------|-------------|
|  Tél: (450) 979-4373 Fax: (450) 979-4626 www.exmweb.com | | Flatness Aplatissement | |
| | | Max 3.0mm | |
| Customer Client | | Date | |
| Drawn By Dessiné Par | | Date 23-Jan-07 | |
| Material Matière | | Polyisocyanurate | |
| Color Couleur | Aluminum | Finish Fini | N/A |
| Description | | | Detail Rev. |
| 5412ESTH 30" x 20" Left Insulation | | | |
| Part Number Numéro Pièce | | Rev. | 12 |
| 5412ESTH302008I-LS | | 0 | 16 |

This drawing is confidential and must not be reproduced or used without the consent of EXM

Ce dessin est confidentiel et ne doit pas être reproduit ou utilisé sans le consentement de EXM

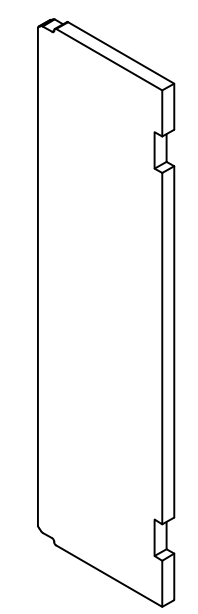
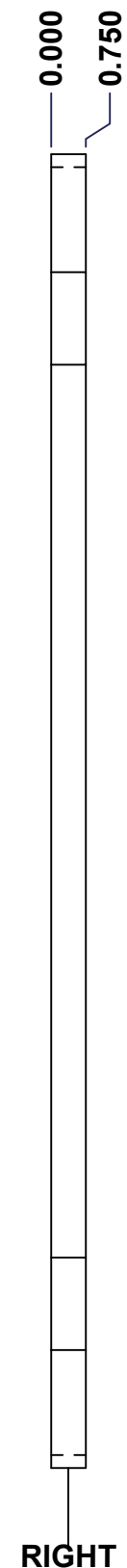
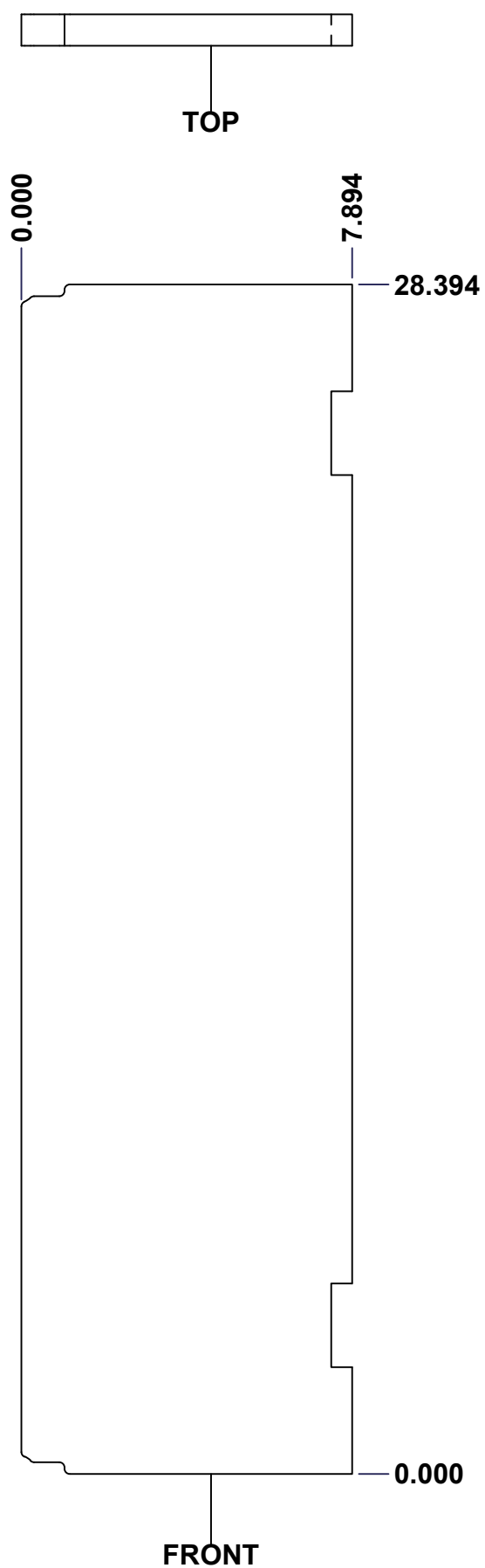

Isometric View

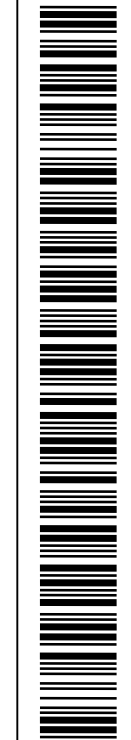

| No. | Revisions | Date | By/Par |
|-----|-----------|------|--------|
| | | | |
| | | | |
| | | | |
| | | | |
| | | | |

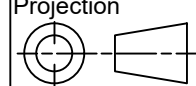
| | | |
|--|--------------------|---|
|  Tél: (450) 979-4373 Fax: (450) 979-4626 www.exmweb.com | | Flatness Aplatissement Max 3.0mm |
| Customer Client | | Projection  |
| Drawn By / Dessiné Par: BoxCad: Patrick Deschenes | | Date: 23-Jan-07 |
| Material / Matière: Polyisocyanurate | | |
| Color / Couleur: Aluminum | Finish / Fini: N/A | |
| Description: 5412ESTH 30" x 20" Right Insulation | | Detail Rev. |
| Part Number / Numéro Pièce: 5412ESTH302008I-RS | | Rev. 13 / 16 |

SEE BILL OF MATERIAL ON LAST PAGE

This drawing is confidential and must not be reproduced or used without the consent of EXM

Ce dessin est confidentiel et ne doit pas être reproduit ou utilisé sans le consentement de EXM



TOP



FRONT

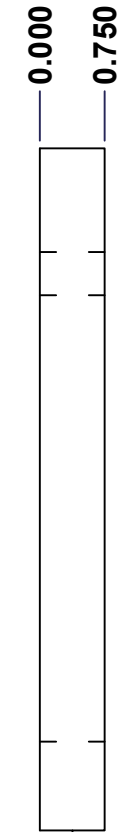

RIGHT

| No. | Revisions | Date | By/Par |
|-----|-----------|------|--------|
| | | | |
| | | | |
| | | | |
| | | | |
| | | | |

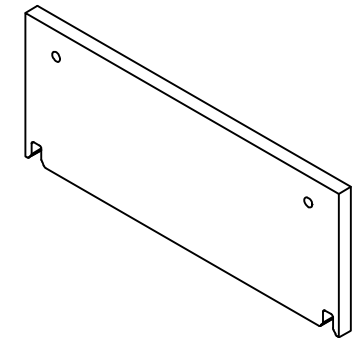

Isometric View

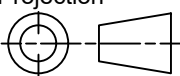

| | | |
|--|---------------------------|---|
|  Tél: (450) 979-4373 Fax: (450) 979-4626 www.exmweb.com | Flatness Aplatissement | Max 3.0mm |
| | Projection |  |
| Customer Client | Date | |
| Drawn By Dessiné Par | BoxCad: Patrick Deschenes | Date 23-Jan-07 |
| Material Matière | Polyisocyanurate | |
| Color Couleur | Aluminum | Finish Fini N/A |
| Description | Detail Rev. | |
| 5412ESTH 30" x 20" Top and Bottom Insulation | | |
| Part Number Numéro Pièce | Rev. | 14 |
| 5412ESTH302008I-TP | 0 | 16 |

SEE BILL OF MATERIAL ON LAST PAGE

This drawing is confidential and must not be reproduced or used without the consent of EXM

Ce dessin est confidentiel et ne doit pas être reproduit ou utilisé sans le consentement de EXM



TOP



FRONT



RIGHT

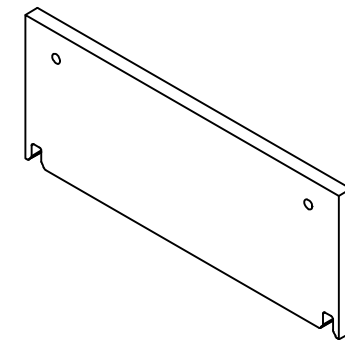

Isometric View



Tél: (450) 979-4373
Fax: (450) 979-4626
www.exmweb.com

Flatness
Aplatissement

Max 3.0mm

Projection

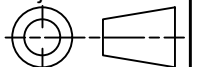

| | |
|---|---------------------|
| Customer Client | Date |
| Drawn By Dessiné Par BoxCad: Patrick Deschenes | Date 23-Jan-07 |
| Material Matière Polyisocyanurate | |
| Color Couleur Aluminum | Finish Fini N/A |
| Description 5412ESTH 30" x 20" Top and Bottom Insulation | Detail Rev. |
| Part Number Numéro Pièce 5412ESTH302008I-BT | Rev. 15 0 |

SEE BILL OF MATERIAL ON LAST PAGE

This drawing is confidential and must not be reproduced or used without the consent of EXM

Ce dessin est confidentiel et ne doit pas être reproduit ou utilisé sans le consentement de EXM

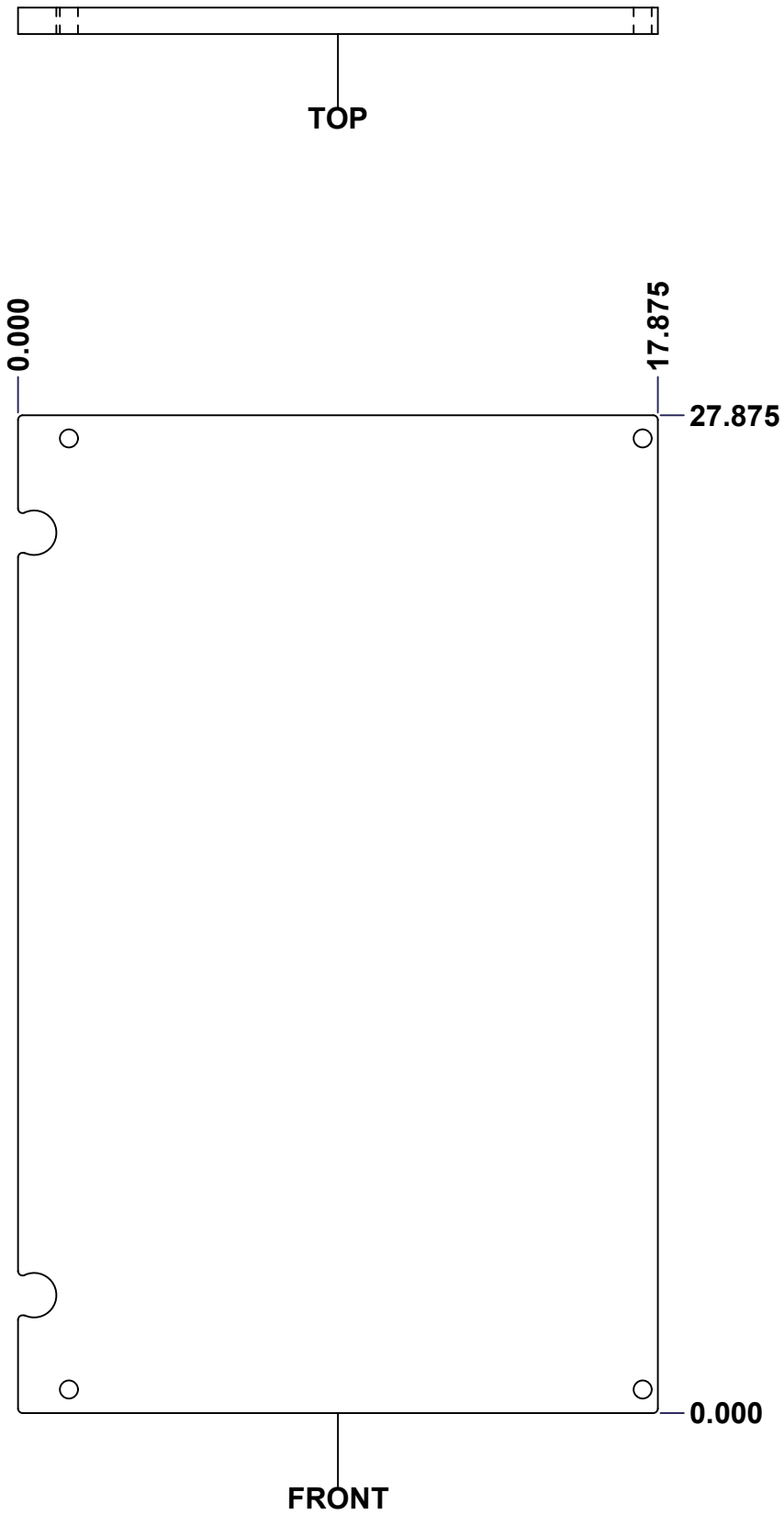

| No. | Revisions | Date | By/Par |
|-----|-----------|------|--------|
| | | | |
| | | | |
| | | | |
| | | | |
| | | | |

Isometric View

| | | |
|--|---------------------------|--|
| Tél: (450) 979-4373 Fax: (450) 979-4626 www.exmweb.com | | Flatness Aplatissement Max 3.0mm Projection |
| Customer Client | Date | |
| Drawn By Dessiné Par | BoxCad: Patrick Deschenes | Date 23-Jan-07 |
| Material Matière | Polyisocyanurate | |
| Color Couleur | Aluminum | Finish Fini N/A |
| Description 5412ESTH 30" x 20" Cover Insulation | | Detail Rev. |
| Part Number Numéro Pièce | Rev. 0 | 16 / 16 |

SEE BILL OF MATERIAL ON LAST PAGE

5412ESTH302008I-C

This drawing is confidential and must not be reproduced or used without the consent of EXM

Ce dessin est confidentiel et ne doit pas être reproduit ou utilisé sans le consentement de EXM

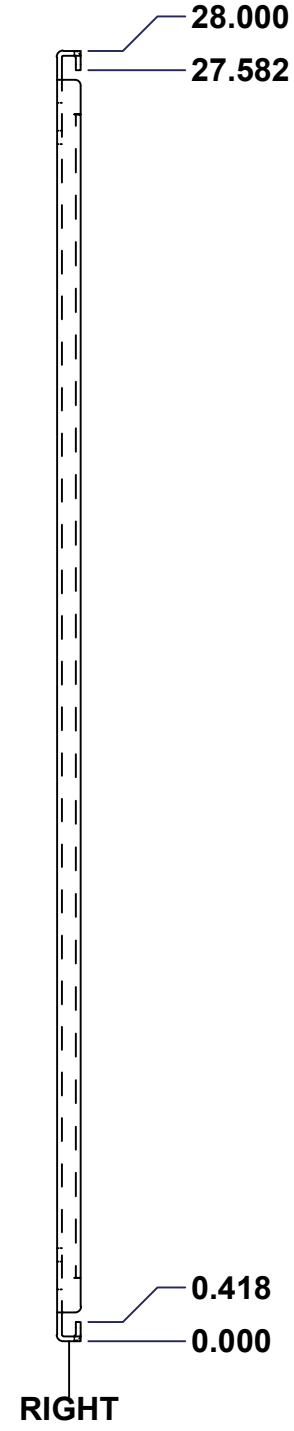
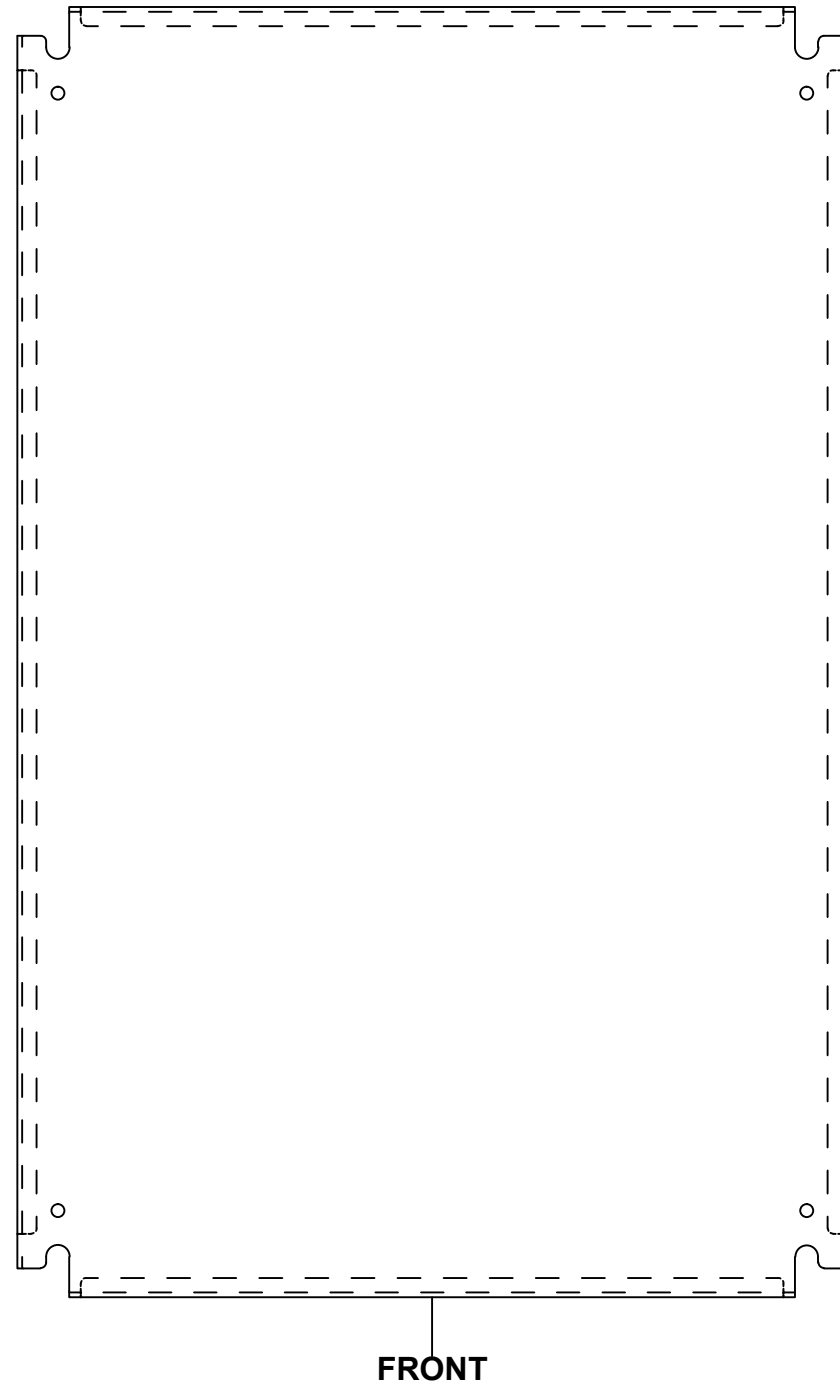
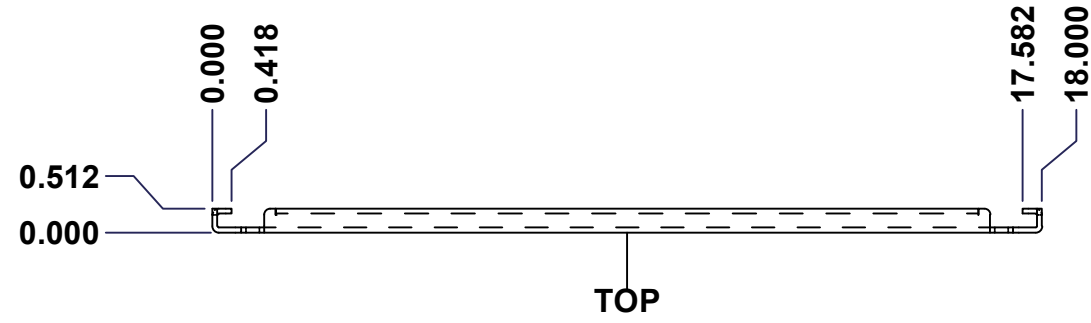

| No. | Revisions | Date | By/Par |
|-----|-----------|------|--------|
| | | | |
| | | | |
| | | | |
| | | | |
| | | | |

Isometric View

| | | |
|--|---------------|--|
| Tél: (450) 979-4373 Fax: (450) 979-4626 www.exmweb.com | | Flatness Aplatissement Max 3.0mm Projection |
| Customer Client | Date | |
| Drawn By Dessiné Par | BoxCad | Date 23-Jan-07 |
| Material Matière | See Part List | |
| Color Couleur | See Part List | Finish Fini See Part List |
| Description | Detail Rev. | |
| 881 SP - Inner Panel | | |
| Part Number Numéro Pièce | Rev. 0 | 1 2 |
| 881 SP3020G | | |

| Qty | Part Number | Rev | Description | Material | Color | Finish |
|-----|---------------|-----|---------------------------|------------------|-----------|------------|
| 1 | 881 SP3020G-P | 0 | 881 SP - Inner Panel Part | 12 Ga Galvanized | Unpainted | Galvanized |

Parts List

This drawing is confidential and must not be reproduced or used without the consent of EXM

Ce dessin est confidentiel et ne doit pas être reproduit ou utilisé sans le consentement de EXM

| Table 1 | | | FRONT VIEW |
|---------|--------|--------|--------------------------|
| CUT-OUT | XDIM | YDIM | DESCRIPTION |
| 1 | 0.875 | 1.875 | GROUND HOLE (RND Ø0.290) |
| 2 | 17.125 | 1.875 | GROUND HOLE (RND Ø0.290) |
| 3 | 0.875 | 26.125 | GROUND HOLE (RND Ø0.290) |
| 4 | 17.125 | 26.125 | GROUND HOLE (RND Ø0.290) |

All knockouts are actual size / Les disques défonçables sont grandeur réel

| No. | Revisions | Date | By/Par |
|-----|-----------|------|--------|
| | | | |
| | | | |
| | | | |
| | | | |
| | | | |
| | | | |

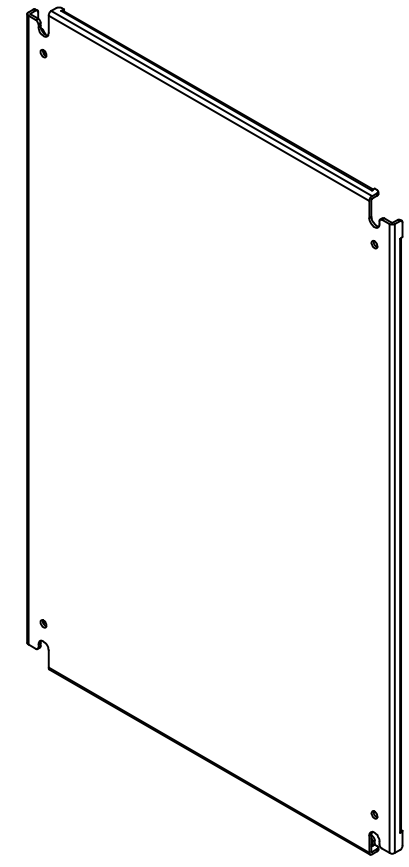
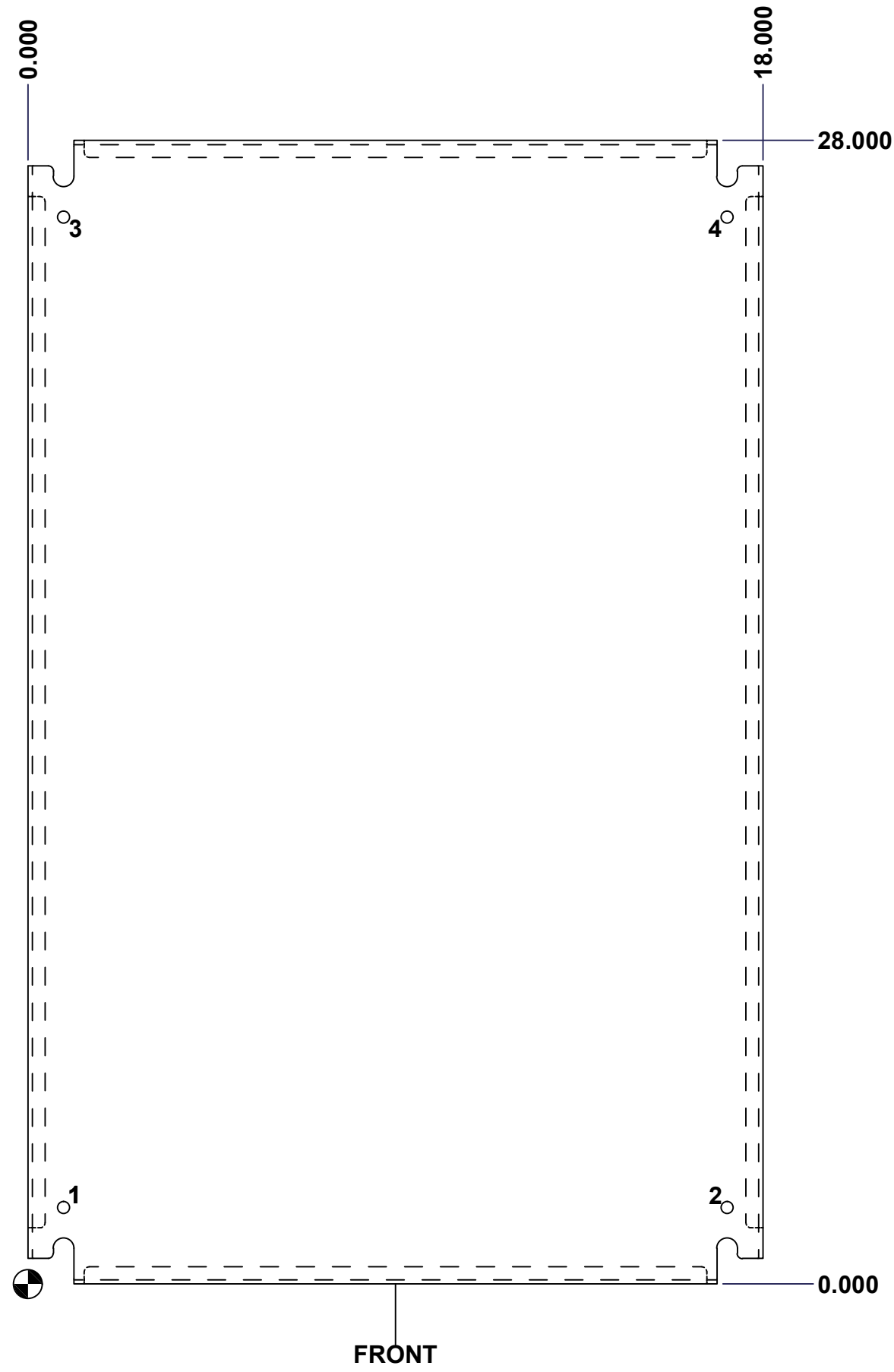

Isometric View



| | | |
|-----------------------------|--|--|
| | Tél: (450) 979-4373 Fax: (450) 979-4626 www.exmweb.com | Flatness Aplatissement Max 3.0mm |
| | Projection | Date Date 23-Jan-07 |
| Customer Client | | |
| Drawn By Dessiné Par | BoxCad | |
| Material Matière | See Part List | |
| Color Couleur | See Part List | Finish Fini See Part List |
| Description | 881 SP - Inner Panel | |
| Part Number Numéro Pièce | 881 SP3020G | Detail Rev. Rev. 2 0 |