

This drawing is confidential and must not be reproduced or used without the consent of EXM

Ce dessin est confidentiel et ne doit pas être reproduit ou utilisé sans le consentement de EXM

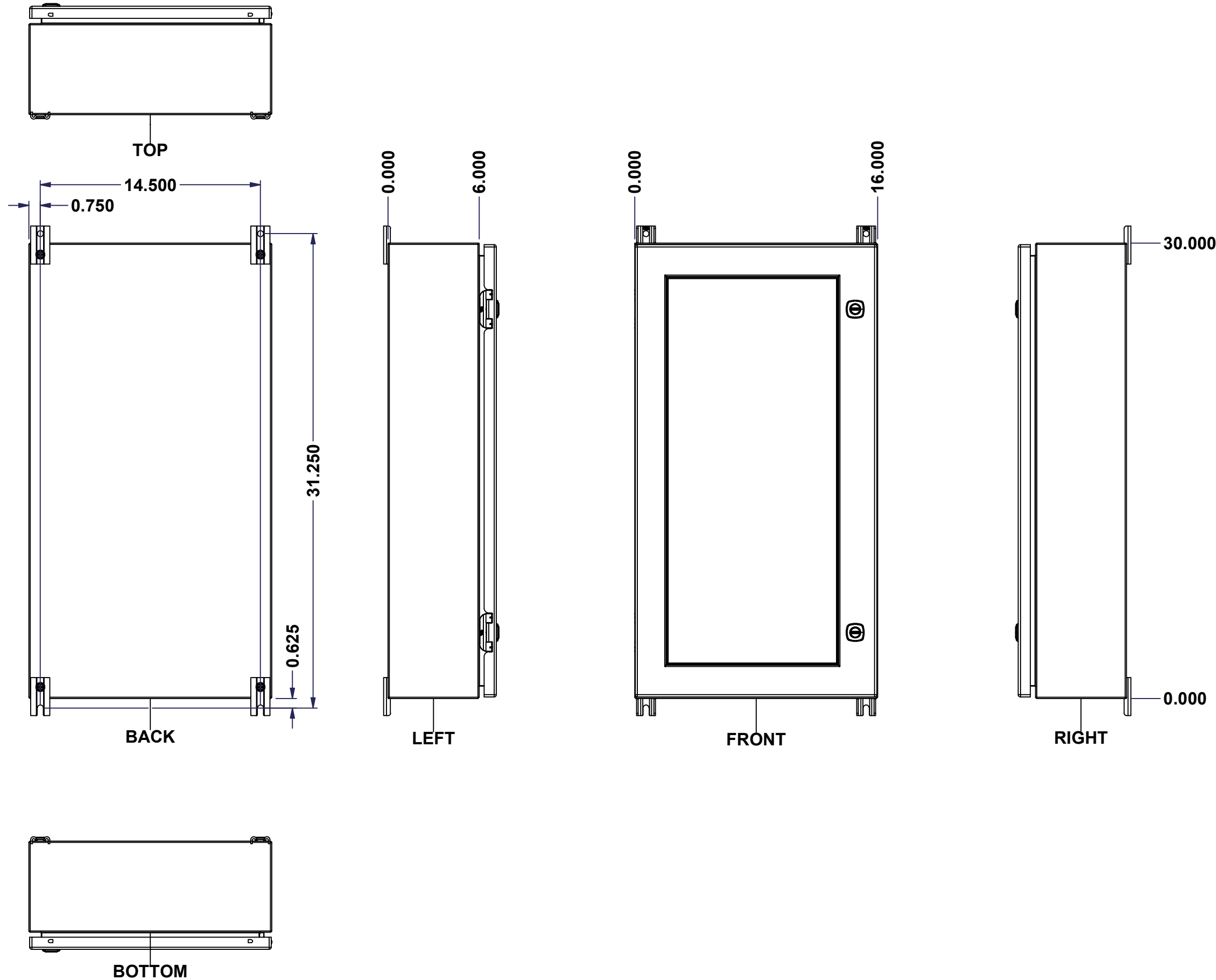

No.	Revisions	Date	By/Par

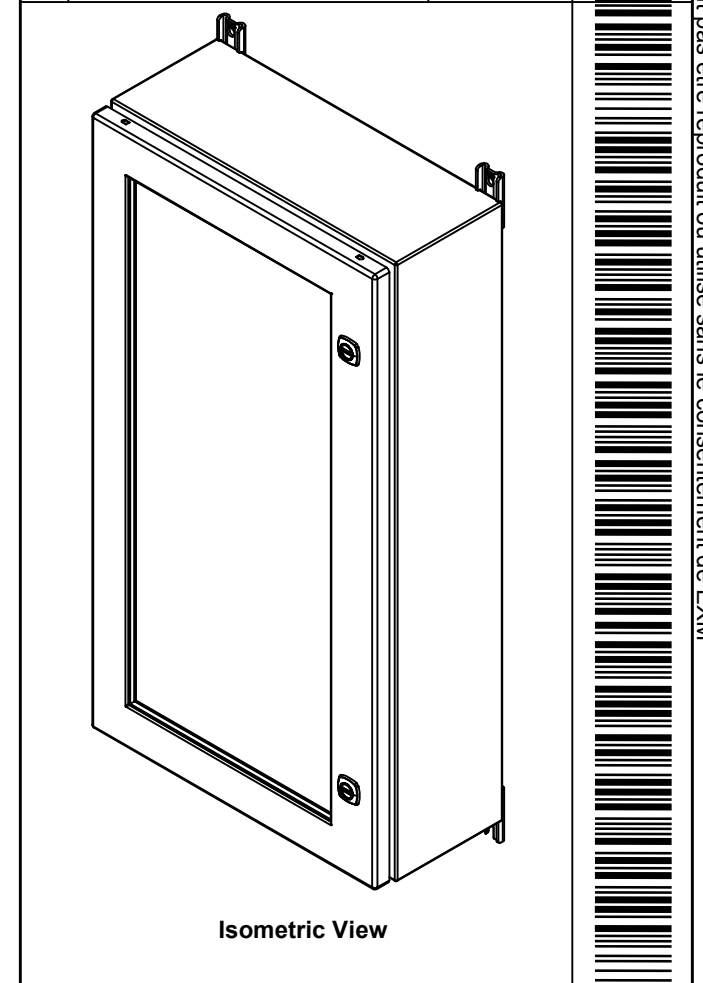

Tél: (450) 979-4373 Fax: (450) 979-4626 <a href="http://www.exmweb.com">www.exmweb.com</a>		Flatness Aplatissement Max 3.0mm Projection 
Customer Client	Date	
Drawn By Dessiné Par	BoxCad: BoxCad	Date 21-Mar-23
Material Matière	16 Ga Cold Rolled A1008 CS Type B (1.4mm)	
Color Couleur	Asa-61 Grey	Finish Fini Smooth
Description	Detail Rev.	
5412ESW 30" x 16" x 6" Assembly		
Part Number Numéro Pièce	Rev. 0	1 / 15

**SEE BILL OF MATERIAL ON LAST PAGE 5412ESW301606THNOIP**

This drawing is confidential and must not be reproduced or used without the consent of EXM

Ce dessin est confidentiel et ne doit pas être reproduit ou utilisé sans le consentement de EXM

NOTE	
ITEM	DESCRIPTION
1	NEMA 4/12 Enclosure
2	C/W Standard ground studs on box and cover
3	W/O Standard door stiffener
4	W/O Inner panel
5	C/W Standard inner panel mounting studs
6	C/W 885 ESMF3_OPEN Sold separately (Installed)
7	C/W 885 ESMF3_CLOSE Sold separately (Installed)
8	C/W R5 Insulation (Installed by EXM)

No.	Revisions	Date	By/Par

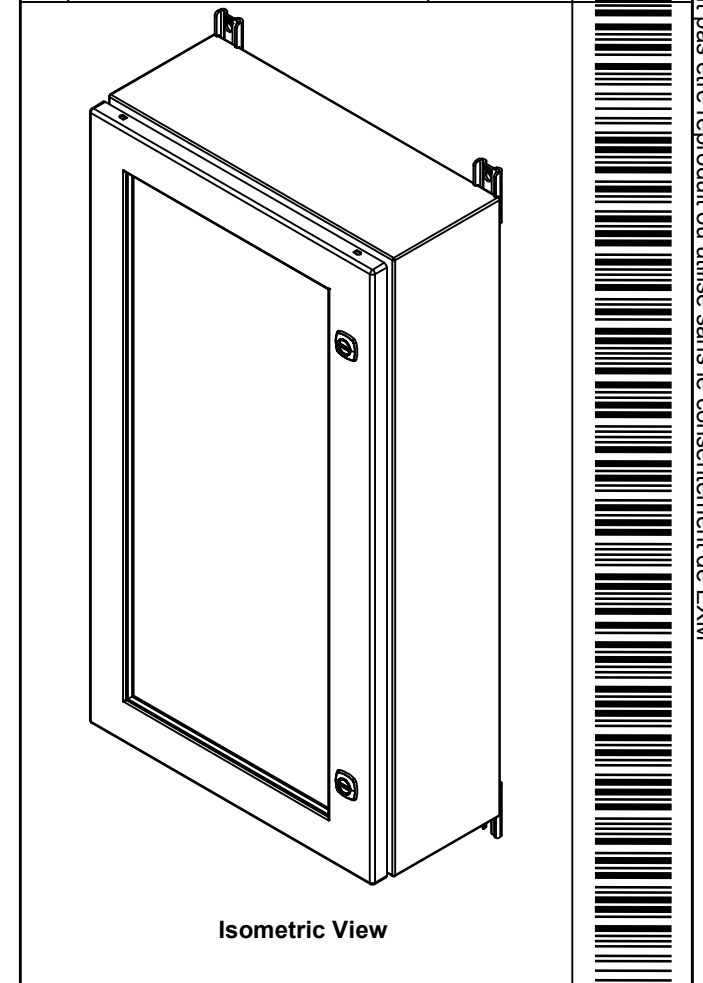

Tél: (450) 979-4373  
Fax: (450) 979-4626  
[www.exmweb.com](http://www.exmweb.com)

Flatness  
Aplatissement  
Max 3.0mm  
Projection

Customer Client	Date
Drawn By / Dessiné Par: BoxCad: BoxCad	Date: 21-Mar-23
Material / Matière: 16 Ga Cold Rolled A1008 CS Type B (1.4mm)	

PACKING		
ITEM	QTY	DESCRIPTION
Cardboard sleeve	2	Top and Bottom
Cardboard strip	2	Between back of enclosure and inner panel
Plastic bag	1	To protect cover surface and inside gasket
Plastic strap - Black	2	To Squeeze the 2 cardboard sleeve together
Packaging label	1	White label with product number

4	STK-Q-00600	2	M12 to M8 Adaptor
1	STK-K-01800	5	5412 ES Accessory Kit
1	5412ESW301606THNOIP C	0	5412ESW 30" x 16" Cover
1	5412ESW301606THNOIP B	0	5412ESW 30" x 16" x 6" Body
2	STK-Q-04050-08	0	M6 x 8mm Hexagon Socket Head Machine Screw
Qty	Part Number	Rev	Description
Parts List			

Color / Couleur: Asa-61 Grey	Finish / Fini: Smooth
Description: 5412ESW 30" x 16" x 6" Assembly	
Part Number / Numéro Pièce: <b>5412ESW301606THNOIP</b>	Rev. 0
2 / 15	

This drawing is confidential and must not be reproduced or used without the consent of EXM

Ce dessin est confidentiel et ne doit pas être reproduit ou utilisé sans le consentement de EXM

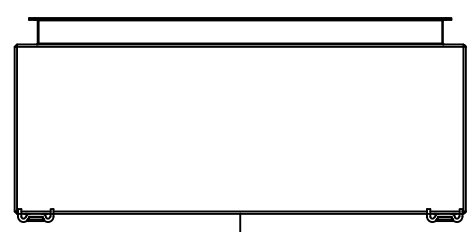

TOP

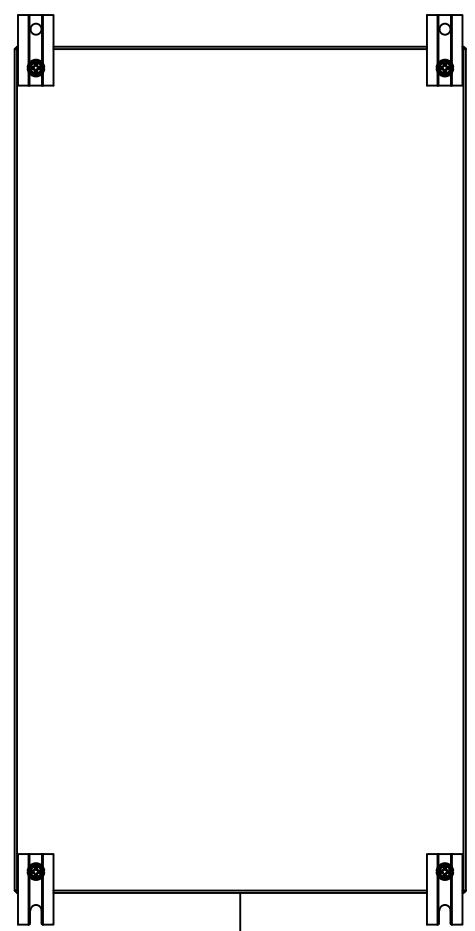

BACK

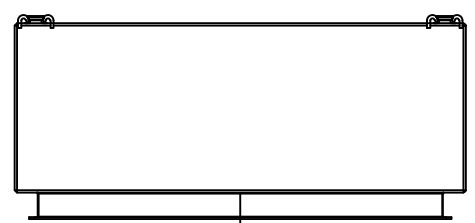

BOTTOM

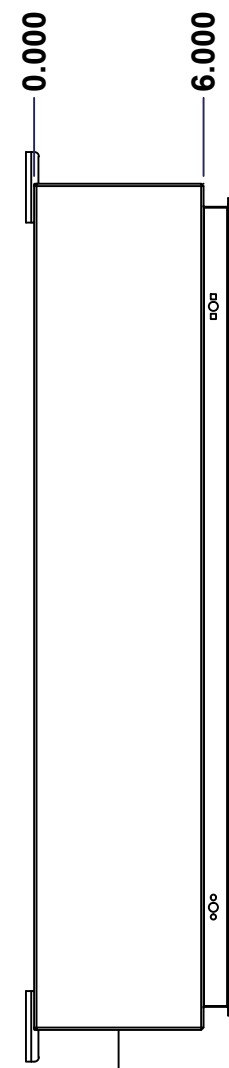

LEFT

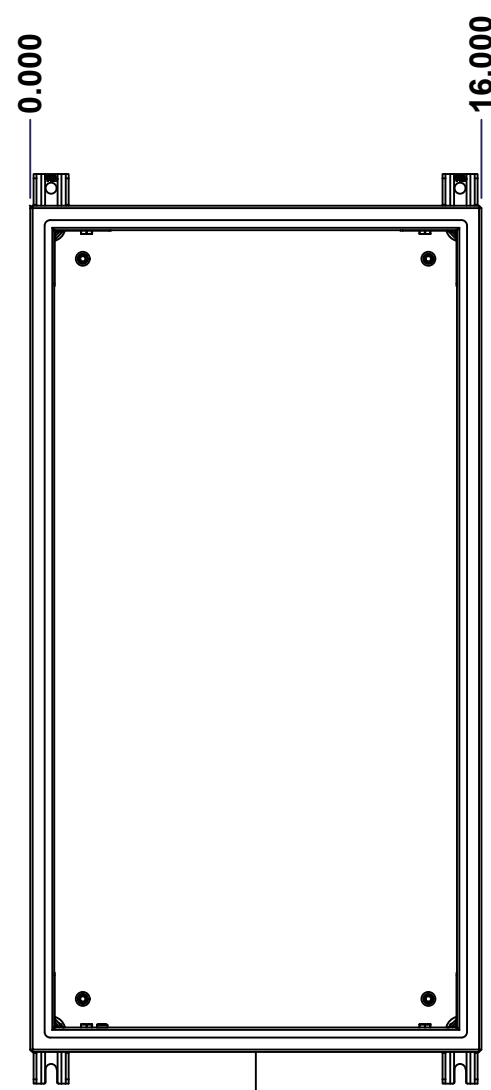

FRONT

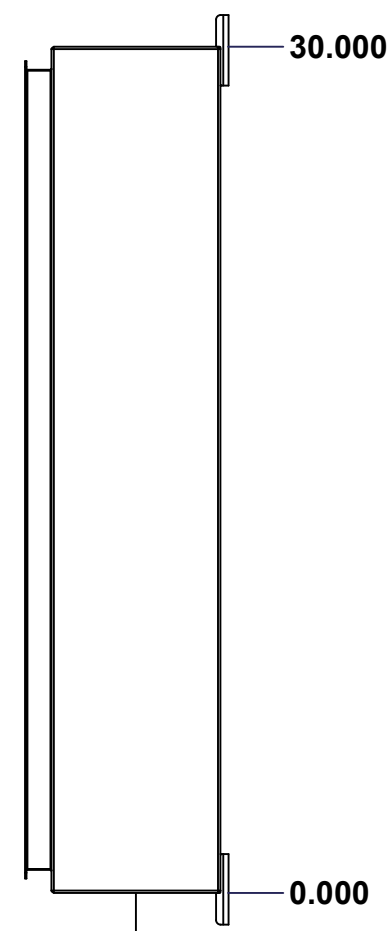

RIGHT

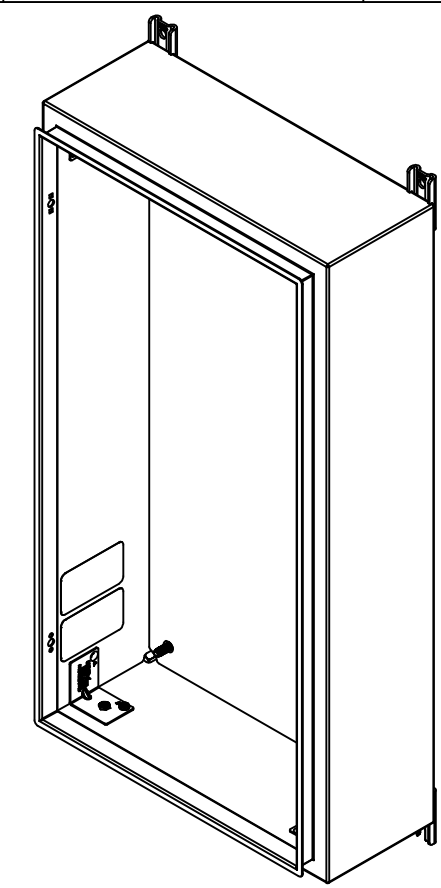

Isometric View

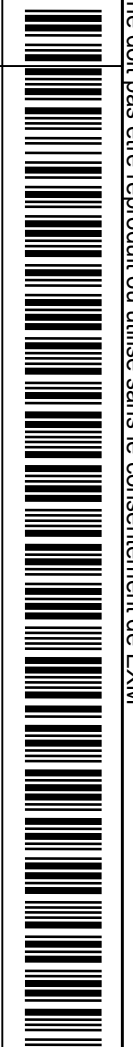

No.	Revisions	Date	By/Par

		Flatness / Aplatissement Max 3.0mm Projection 	
Customer / Client Drawn By / Dessiné Par: BoxCad: BoxCad Material / Matière: 16 Ga Cold Rolled A1008 CS Type B (1.4mm)		Date: 21-Mar-23	
Color / Couleur: Asa-61 Grey Finish / Fini: Smooth		Description: 5412ESW 30" x 16" x 6" Body	
Part Number / Numéro Pièce: 5412ESW301606THNOIPB		Rev.: 0	3 / 15

SEE BILL OF MATERIAL ON LAST PAGE

This drawing is confidential and must not be reproduced or used without the consent of EXM

Ce dessin est confidentiel et ne doit pas être reproduit ou utilisé sans le consentement de EXM

STANDARD FEATURES ARE NOT LISTED IN THIS HOLE TABLE			
HOLE TABLE - TOP VIEW (CUSTOM FEATURE ONLY)			
CUT-OUT	XDIM	YDIM	DESCRIPTION
1	2.000	4.500	INSUL. STUD M6 x 18mm (Inside)
2	14.000	4.500	INSUL. STUD M6 x 18mm (Inside)

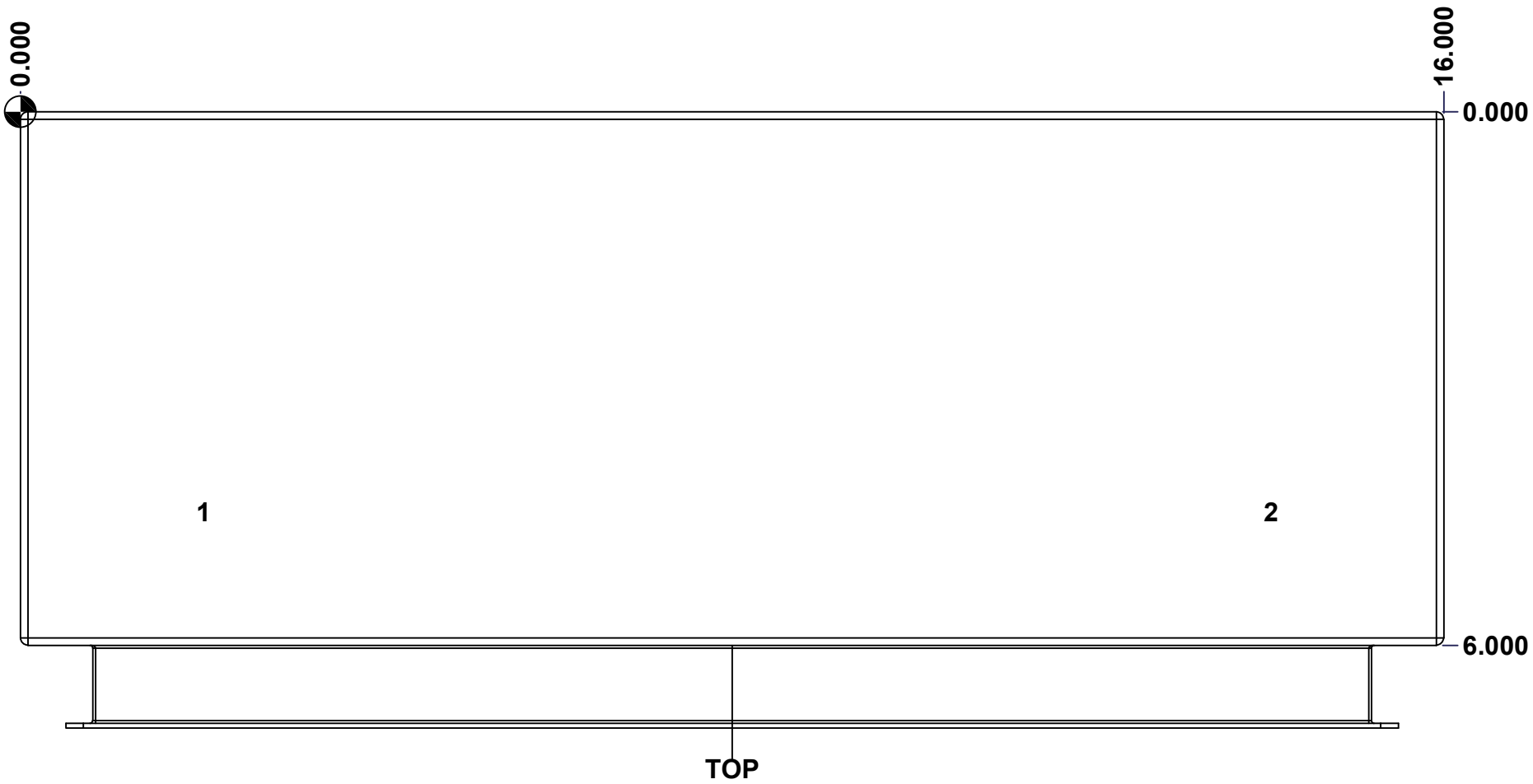

	Description	Status
	5412ESW 30" x 16" x 6" Body	(NULL)
	Part Number Numéro Pièce	Rev.
	<b>5412ESW301606THNOIPB</b>	<b>0</b>
		4
		15

This drawing is confidential and must not be reproduced or used without the consent of EXM

Ce dessin est confidentiel et ne doit pas être reproduit ou utilisé sans le consentement de EXM

<b>STANDARD FEATURES ARE NOT LISTED IN THIS HOLE TABLE</b>			
<b>HOLE TABLE - BOTTOM VIEW (CUSTOM FEATURE ONLY)</b>			
CUT-OUT	XDIM	YDIM	DESCRIPTION
1	2.000	4.500	INSUL. STUD M6 x 18mm (Inside)
2	14.000	4.500	INSUL. STUD M6 x 18mm (Inside)

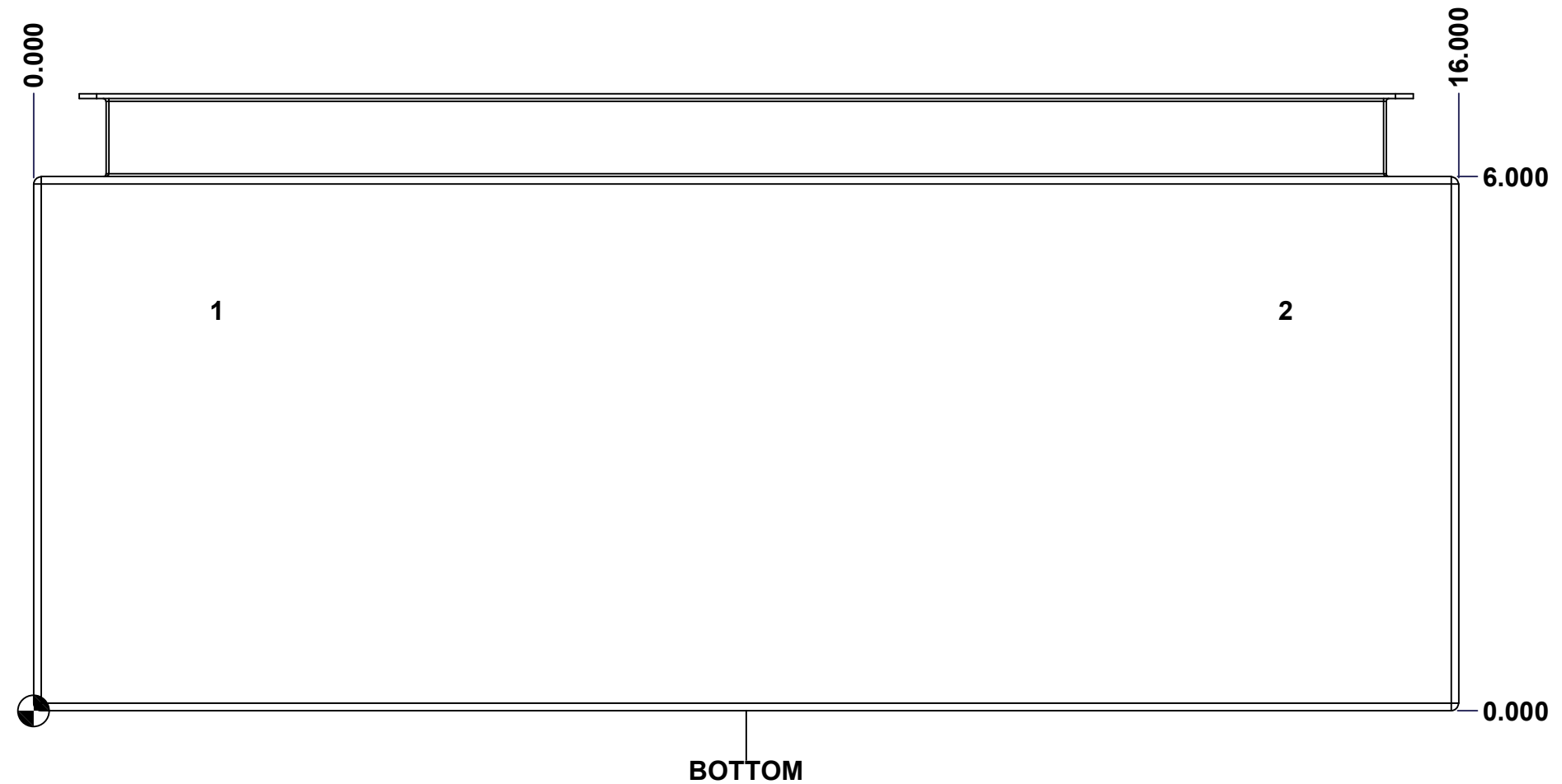

	Description	Status
	5412ESW 30" x 16" x 6" Body	(NULL)
	Part Number Numéro Pièce	Rev.
	<b>5412ESW301606THNOIPB</b>	<b>0</b>
		5
		15

This drawing is confidential and must not be reproduced or used without the consent of EXM

Ce dessin est confidentiel et ne doit pas être reproduit ou utilisé sans le consentement de EXM

**STANDARD FEATURES ARE NOT LISTED IN THIS HOLE TABLE**

**HOLE TABLE - BACK VIEW (CUSTOM FEATURE ONLY)**

CUT-OUT	XDIM	YDIM	DESCRIPTION
1	1.875	1.875	IP STUD M8 x 35mm (Inside)
2	1.875	28.125	IP STUD M8 x 35mm (Inside)
3	14.125	28.125	IP STUD M8 x 35mm (Inside)
4	14.125	1.875	IP STUD M8 x 35mm (Inside)
-----			
5	15.250	0.000	FOOT 885 ESMF3_OPEN
6	0.750	0.000	FOOT 885 ESMF3_OPEN
7	15.250	30.000	FOOT 885 ESMF3_CLOSE
8	0.750	30.000	FOOT 885 ESMF3_CLOSE

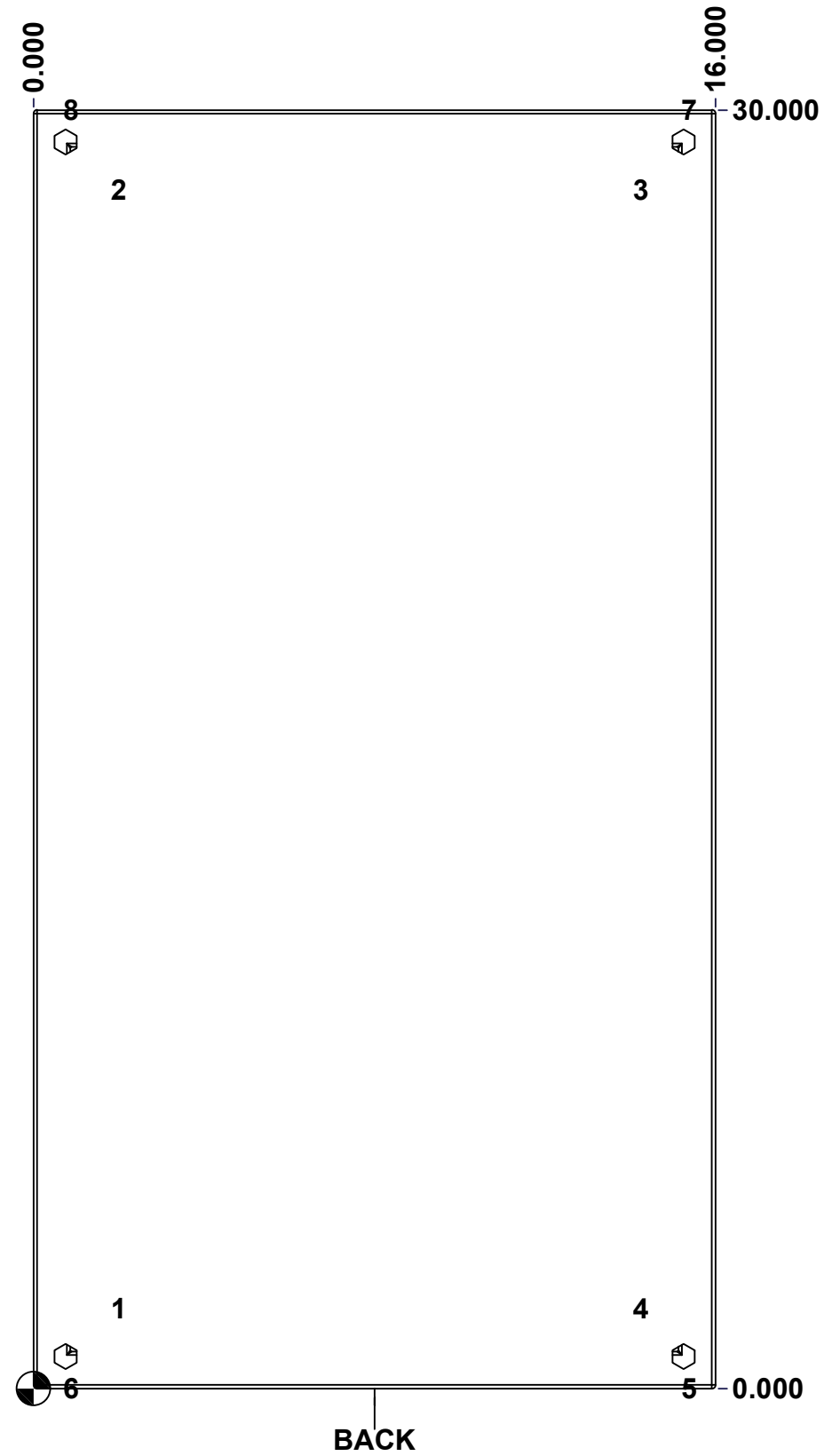

	Description	Status
	5412ESW 30" x 16" x 6" Body	(NULL)
Part Number Numéro Pièce <b>5412ESW301606THNOIPB</b>	Rev.	6
	<b>0</b>	15

This drawing is confidential and must not be reproduced or used without the consent of EXM

Ce dessin est confidentiel et ne doit pas être reproduit ou utilisé sans le consentement de EXM

No.	Revisions	Date	By/Par

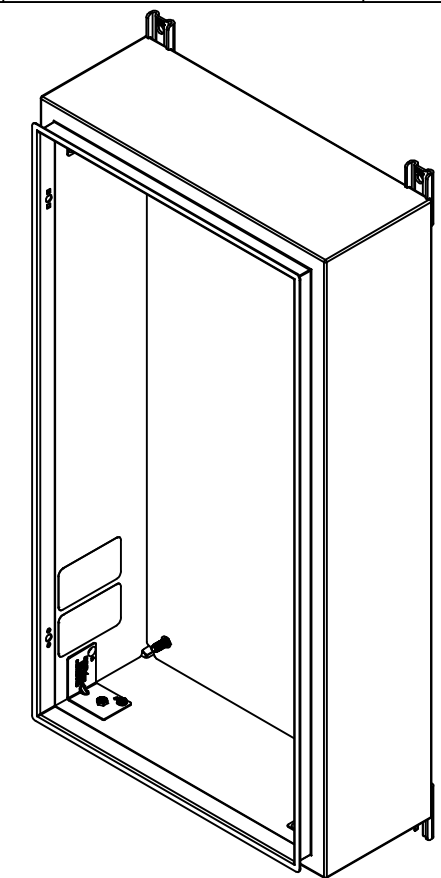

Isometric View



2	885ESMF3-FEET	0	885 ESMF3 Mounting Foot
4	RIVET_NUT_M10_FH_CE	0	Rivet Nut M10 (Low Profile Close End)
4	STK-Q-06660	2	M10 x 16mm Machine Screw
2	885ESMF3-FEET-A	0	885 ESMF3 Mounting Foot (Opened Slot)
2	STK-S-00100	0	3.5" x 2" Silver Milar Flexcon Sticker
1	STK-K-70554	3	5412 ESTH Accessory Kit
1	5412ESW301606THNOIPI-RS	0	5412ESW 30" x 16" Right Insulation
1	5412ESW301606THNOIPI-LS	0	5412ESW 30" x 16" Left Insulation
1	5412ESW301606THNOIPI-BT	0	5412ESW 30" x 16" Top and Bottom Insulation
1	5412ESW301606THNOIPI-TP	0	5412ESW 30" x 16" Top and Bottom Insulation
1	5412ESW301606THNOIPI-B	0	5412ESW 30" x 16" Back Insulation
4	STK-Q-16055	1	M6 x 18mm Stud (No Paint Cap Required)
1	STK-P-02400S	0	Powder Paint (Asa-61 Grey / Smooth)
4	STK-Q-16005	1	Stud M8 x 35 (No Paint Cap Required)
1	5412ESW301606THNOIPB-P	0	5412ESW 30" x 16" x 6" Body Part

Qty	Part Number	Rev	Description
Parts List			

<p>Tél: (450) 979-4373 Fax: (450) 979-4626 <a href="http://www.exmweb.com">www.exmweb.com</a></p>	<p>Flatness Aplatissement Max 3.0mm</p>
	<p>Projection</p>
Customer Client	Date
Drawn By Dessiné Par BoxCad: BoxCad	Date 21-Mar-23
Material Matière 16 Ga Cold Rolled A1008 CS Type B (1.4mm)	
Color Couleur Asa-61 Grey	Finish Fini Smooth
Description 5412ESW 30" x 16" x 6" Body	Detail Rev.
Part Number Numéro Pièce <b>5412ESW301606THNOIPB</b>	Rev. <b>0</b>

This drawing is confidential and must not be reproduced or used without the consent of EXM

Ce dessin est confidentiel et ne doit pas être reproduit ou utilisé sans le consentement de EXM

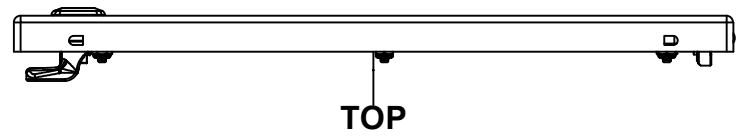

TOP

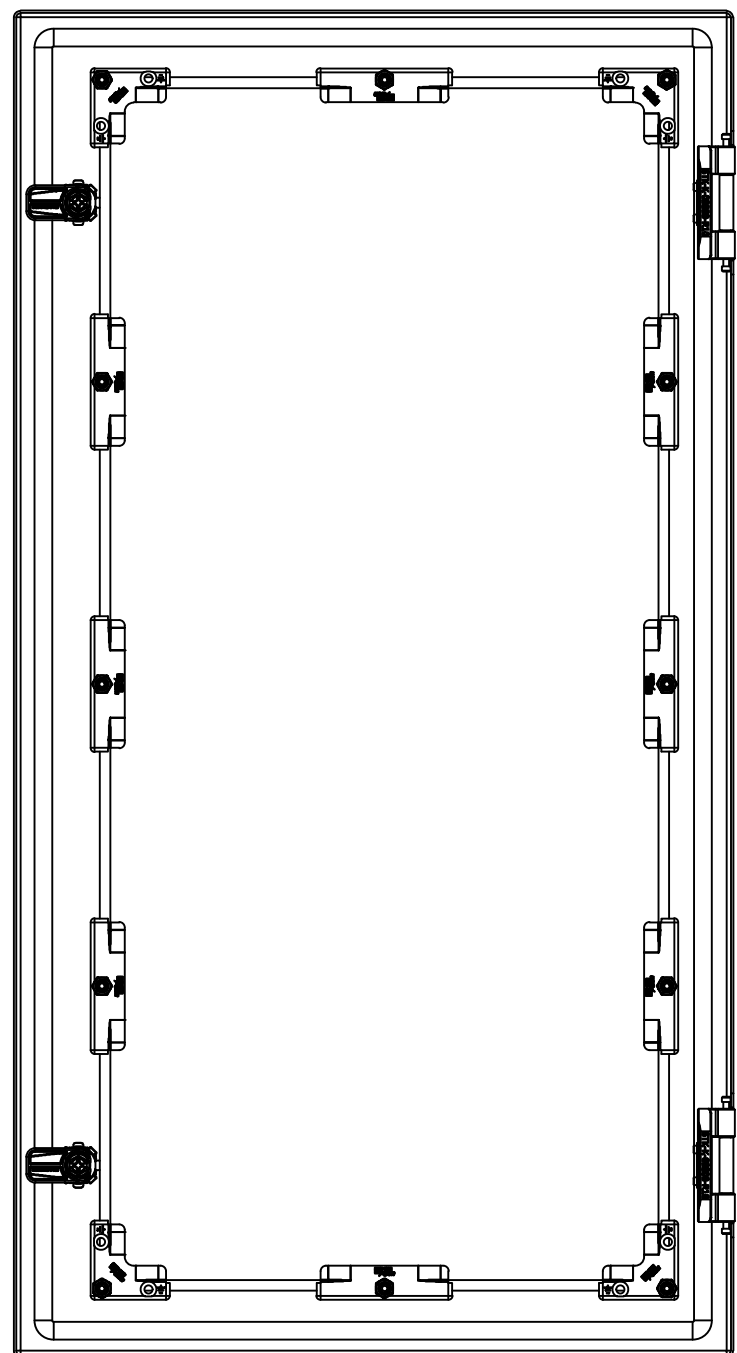

BACK



BOTTOM

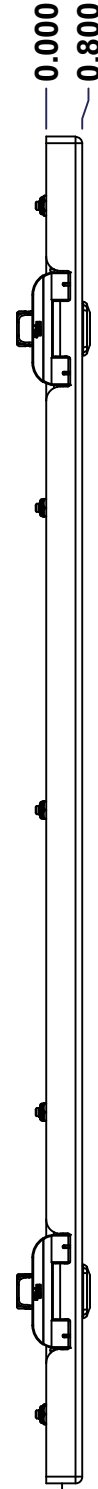

LEFT

0.000  
0.800

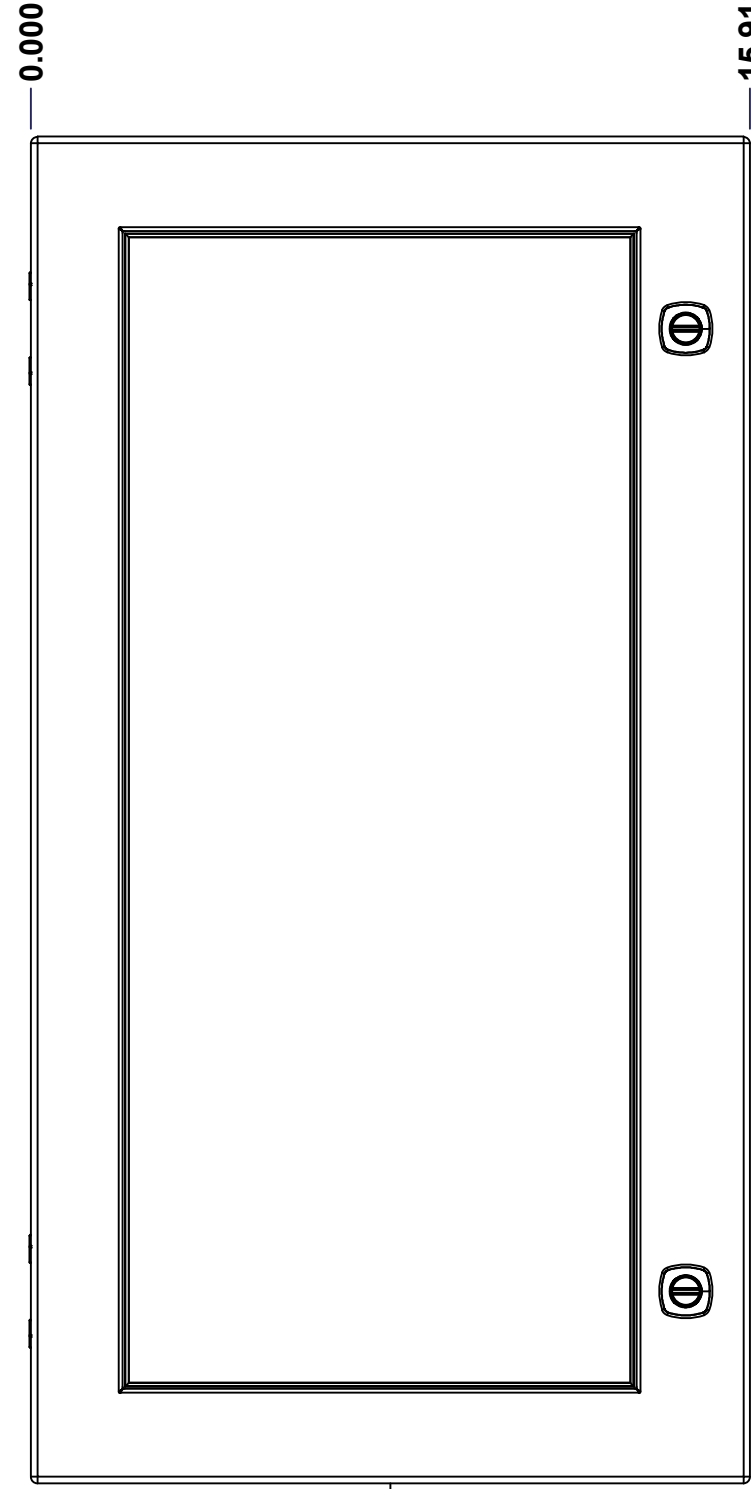

FRONT

0.000  
15.918

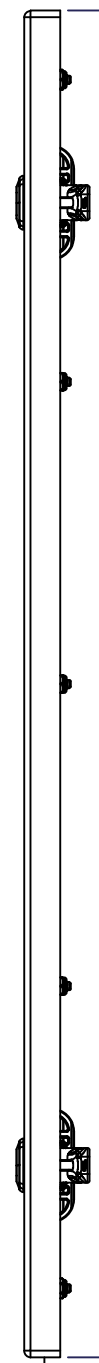

RIGHT

29.803

0.000

No.	Revisions	Date	By/Par

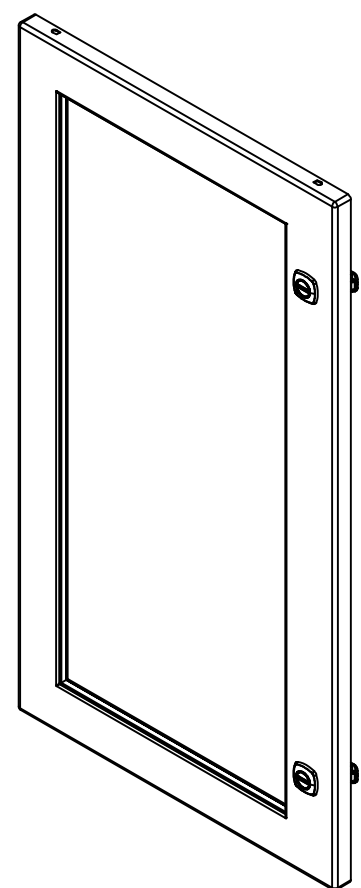

Isometric View

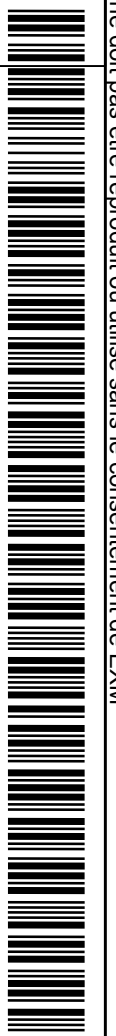

Tél: (450) 979-4373  
Fax: (450) 979-4626  
[www.exmweb.com](http://www.exmweb.com)

Flatness  
Aplatissement  
Max 3.0mm  
Projection

Customer Client	Date
Drawn By Dessiné Par BoxCad: BoxCad	Date 21-Mar-23
Material Matière 16 Ga Cold Rolled A1008 CS Type B (1.4mm)	
Color Couleur Asa-61 Grey	Finish Fini Smooth
Description 5412ESW 30" x 16" Cover	Detail Rev.
Part Number Numéro Pièce 5412ESW301606THNOIPC	Rev. 8
	0



This drawing is confidential and must not be reproduced or used without the consent of EXM

Ce dessin est confidentiel et ne doit pas être reproduit ou utilisé sans le consentement de EXM

**STANDARD FEATURES ARE NOT LISTED IN THIS HOLE TABLE**

**HOLE TABLE - FRONT VIEW (CUSTOM FEATURE ONLY)**

CUT-OUT	XDIM	YDIM	DESCRIPTION
1	1.469	8.214	STUD M6 x 18mm (Inside)
2	13.968	8.214	STUD M6 x 18mm (Inside)
3	1.469	14.902	STUD M6 x 18mm (Inside)
4	13.968	14.902	STUD M6 x 18mm (Inside)
5	1.469	21.589	STUD M6 x 18mm (Inside)
6	13.968	21.589	STUD M6 x 18mm (Inside)
7	1.469	28.276	STUD M6 x 18mm (Inside)
8	1.469	1.527	STUD M6 x 18mm (Inside)
9	7.719	28.276	STUD M6 x 18mm (Inside)
10	7.719	1.527	STUD M6 x 18mm (Inside)
11	13.968	28.276	STUD M6 x 18mm (Inside)
12	13.968	1.527	STUD M6 x 18mm (Inside)
-----			
13	14.494	25.553	880 SCQ4-SL
14	14.494	4.250	880 SCQ4-SL

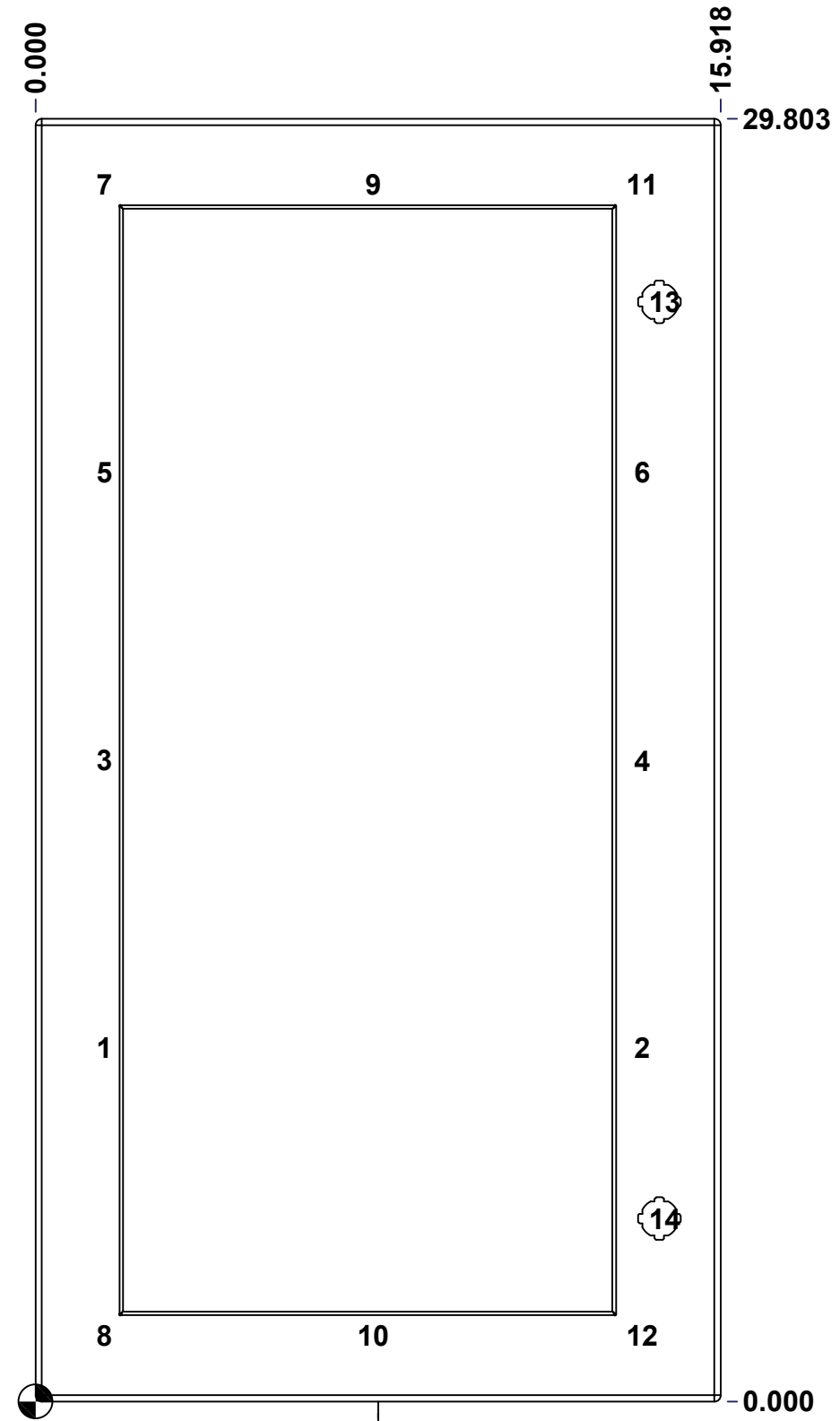

	Description	Status
	5412ESW 30" x 16" Cover	(NULL)
	Part Number Numéro Pièce	Rev.
	<b>5412ESW301606THNOIPC</b>	<b>0</b>
		9
		15

This drawing is confidential and must not be reproduced or used without the consent of EXM

Ce dessin est confidentiel et ne doit pas être reproduit ou utilisé sans le consentement de EXM

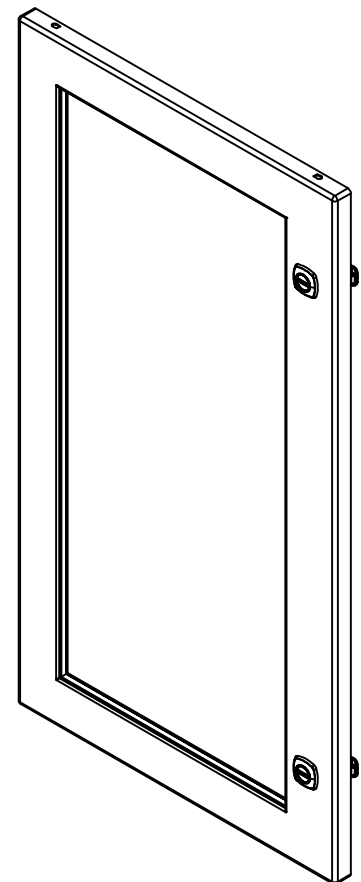

No.	Revisions	Date	By/Par



Isometric View

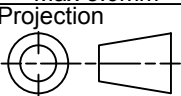

1	STK-P-02400S	0	Powder Paint (Asa-61 Grey / Smooth)
8	STK-Q-60701	2.1	880 WK - Lexan 1/4" Fixing Bracket
1	STK-A-60703	0	5412 ESW Lexan Bracket Kit
12	STK-Q-16052	0	M6 x 23mm Stud (No Paint Cap Required)
1	STK-G-02710	0	880 HWKG - Windows Kit Gasket
1	5412ESW301606THNOIP LXG	0	5412ESW 30" x 16" Lexan Gasket Part
1	5412ESW301606THNOIP LX	0	5412ESW 26.375" x 12.125" Lexan Part
1	5412ESW301606THNOIP G	0	5412ESW 30" x 16" Cover Gasket Part
1	5412ESW301606THNOIP C-P	0	5412ESW 30" x 16" Cover Part
2	STK-K-09800	10	5412 ES Hinge with 2 Captive Hinge Pins
2	STK-K-12500	16	5412 ES 1/4 Turn Lock
QTY	Part Number	Rev	Description
Parts List			

 Tél: (450) 979-4373 Fax: (450) 979-4626 <a href="http://www.exmweb.com">www.exmweb.com</a>		Flatness Aplatissement  Max 3.0mm
Customer Client Drawn By / Dessiné Par: BoxCad: BoxCad Material Matière: 16 Ga Cold Rolled A1008 CS Type B (1.4mm)		Projection 
Color Couleur: Asa-61 Grey Finish Fini: Smooth		Date: 21-Mar-23
Description: 5412ESW 30" x 16" Cover		Detail Rev.
Part Number / Numéro Pièce: <b>5412ESW301606THNOIPC</b>		Rev. 0 / 10 / 15

This drawing is confidential and must not be reproduced or used without the consent of EXM

Ce dessin est confidentiel et ne doit pas être reproduit ou utilisé sans le consentement de EXM

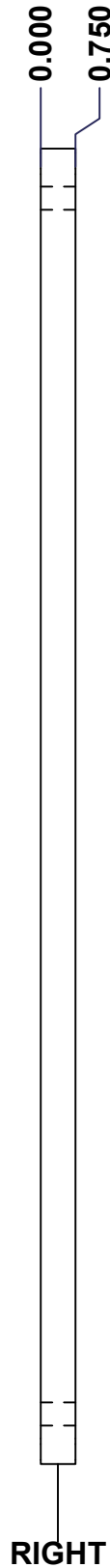
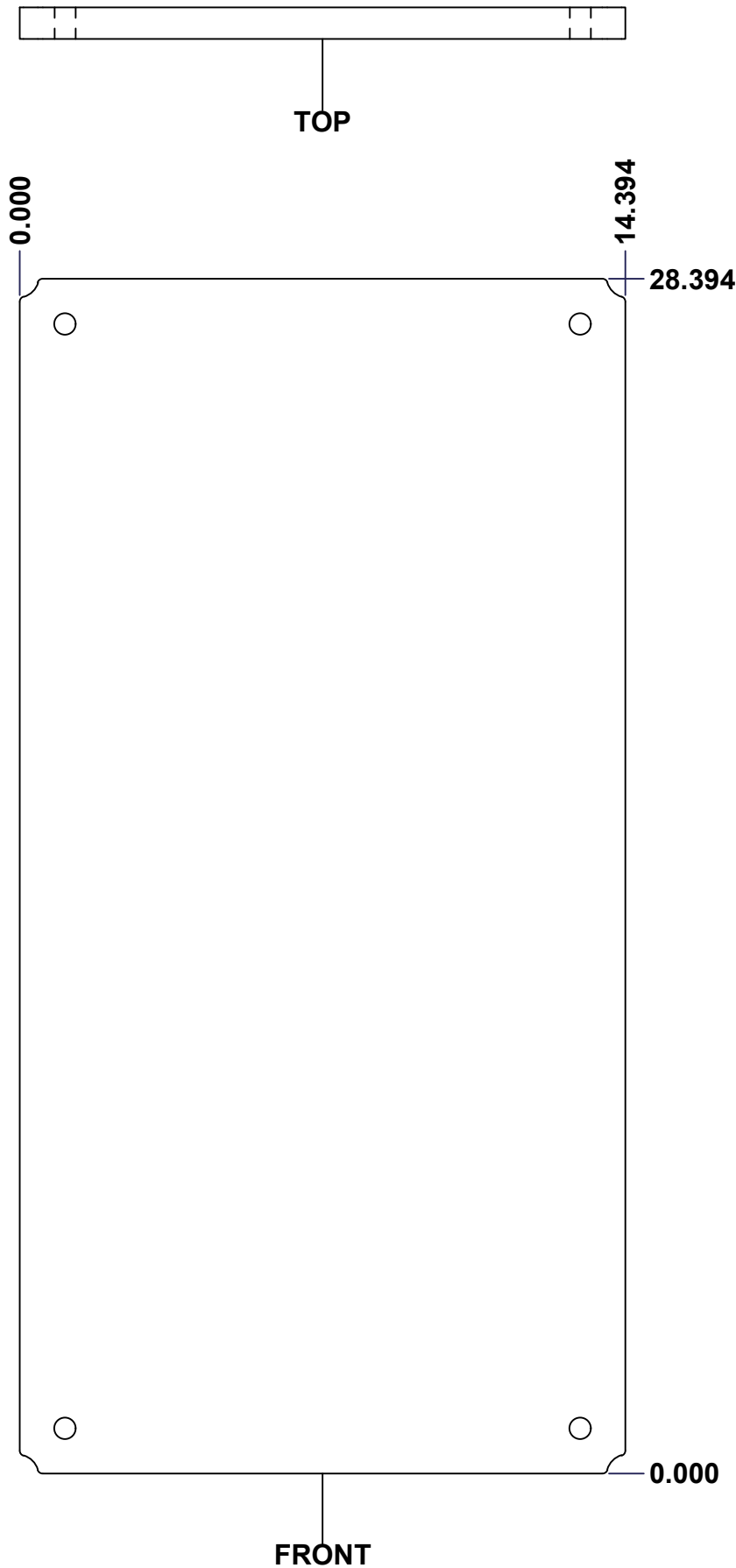

No.	Revisions	Date	By/Par

**Isometric View**

Tél: (450) 979-4373 Fax: (450) 979-4626 <a href="http://www.exmweb.com">www.exmweb.com</a>		Flatness Aplatissement
		Max 3.0mm
Projection		
Customer Client		Date
Drawn By Dessiné Par	BoxCad: Patrick Deschenes	Date 23-Jan-07
Material Matière	Polyisocyanurate	
Color Couleur	Aluminum	Finish Fini N/A
Description		Detail Rev.
5412ESW 30" x 16" Back Insulation		
Part Number Numéro Pièce	Rev. 0	11 / 15

SEE BILL OF MATERIAL ON LAST PAGE **5412ESW301606THNOIP-B**

This drawing is confidential and must not be reproduced or used without the consent of EXM

Ce dessin est confidentiel et ne doit pas être reproduit ou utilisé sans le consentement de EXM

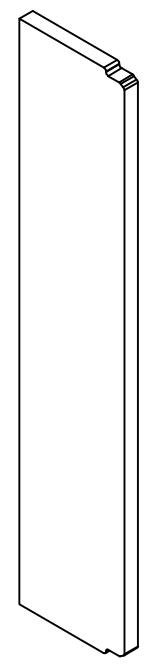
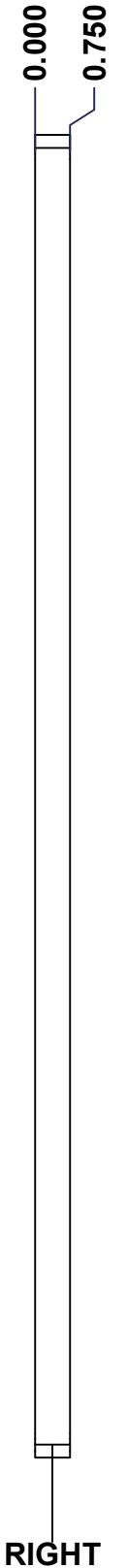
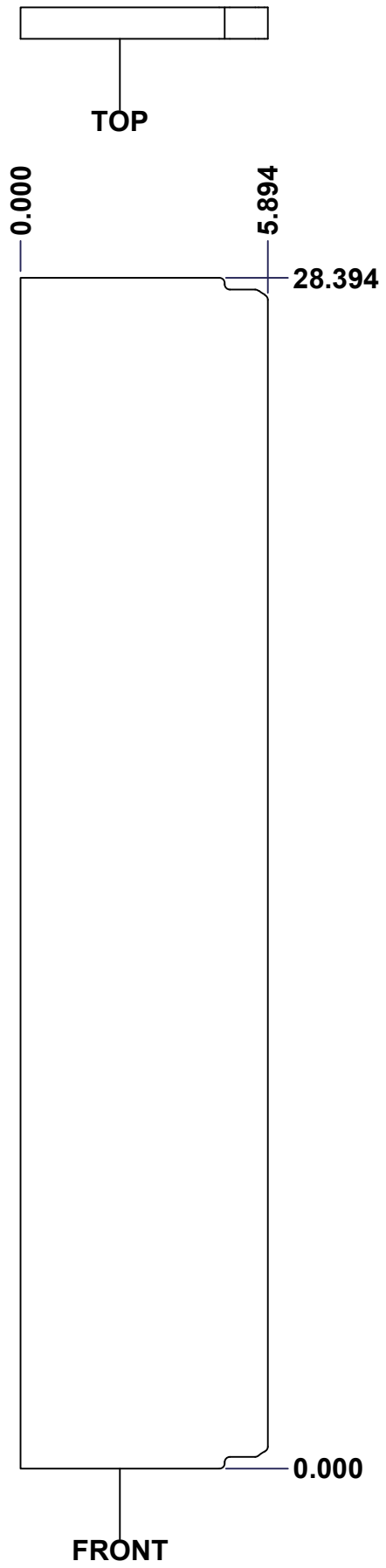

Isometric View

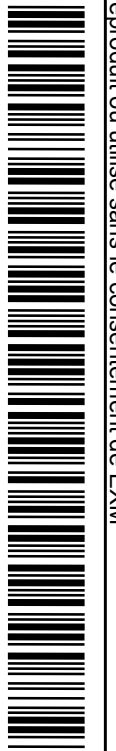

No.	Revisions	Date	By/Par

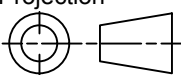
 Tél: (450) 979-4373 Fax: (450) 979-4626 <a href="http://www.exmweb.com">www.exmweb.com</a>		Flatness Aplatissement Max 3.0mm Projection 
Customer Client	Date	
Drawn By Dessiné Par	BoxCad: Patrick Deschenes	Date 23-Jan-07
Material Matière	Polyisocyanurate	
Color Couleur	Aluminum	Finish Fini N/A
Description	Detail Rev.	
5412ESW 30" x 16" Left Insulation		
Part Number Numéro Pièce	Rev.	12
5412ESW301606THNOIPI-LS	0	15

SEE BILL OF MATERIAL ON LAST PAGE

This drawing is confidential and must not be reproduced or used without the consent of EXM

Ce dessin est confidentiel et ne doit pas être reproduit ou utilisé sans le consentement de EXM

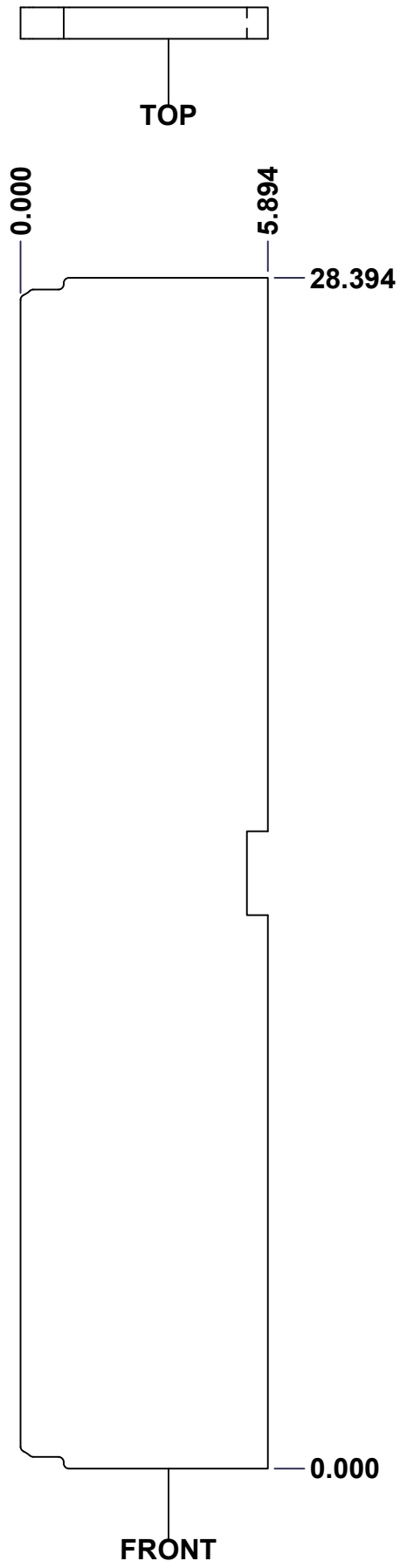

No.	Revisions	Date	By/Par

**Isometric View**

Tél: (450) 979-4373 Fax: (450) 979-4626 <a href="http://www.exmweb.com">www.exmweb.com</a>		Flatness Aplatissement Max 3.0mm
Projection		
Customer Client	Date	
Drawn By Dessiné Par	BoxCad: Patrick Deschenes	Date 23-Jan-07
Material Matière	Polyisocyanurate	
Color Couleur	Aluminum	Finish Fini N/A
Description		Detail Rev.
5412ESW 30" x 16" Right Insulation		
Part Number Numéro Pièce	Rev.	13
SEE BILL OF MATERIAL ON LAST PAGE		0

This drawing is confidential and must not be reproduced or used without the consent of EXM

Ce dessin est confidentiel et ne doit pas être reproduit ou utilisé sans le consentement de EXM

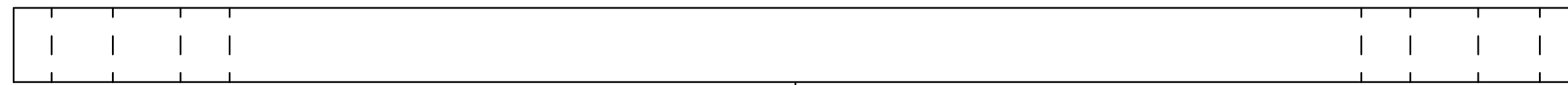

TOP

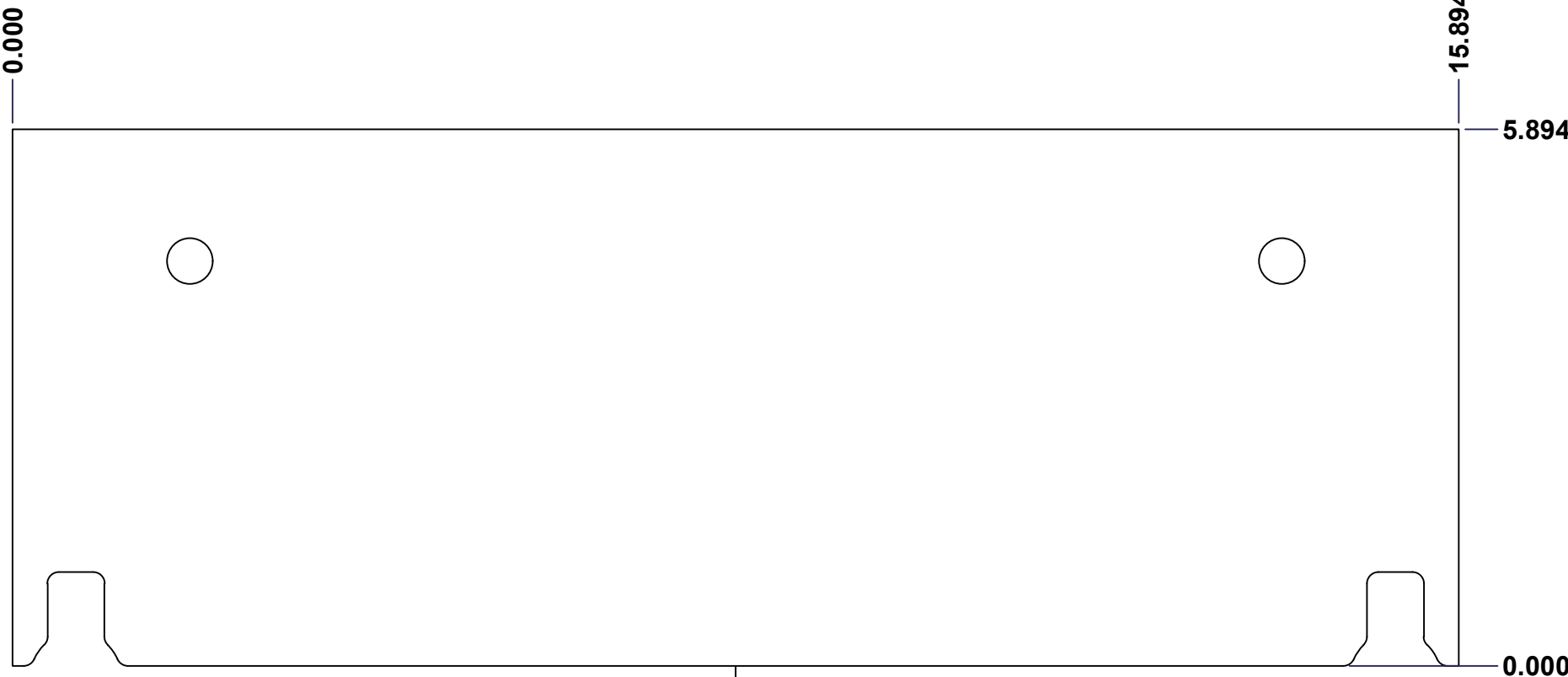

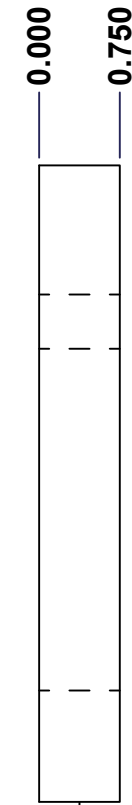

FRONT

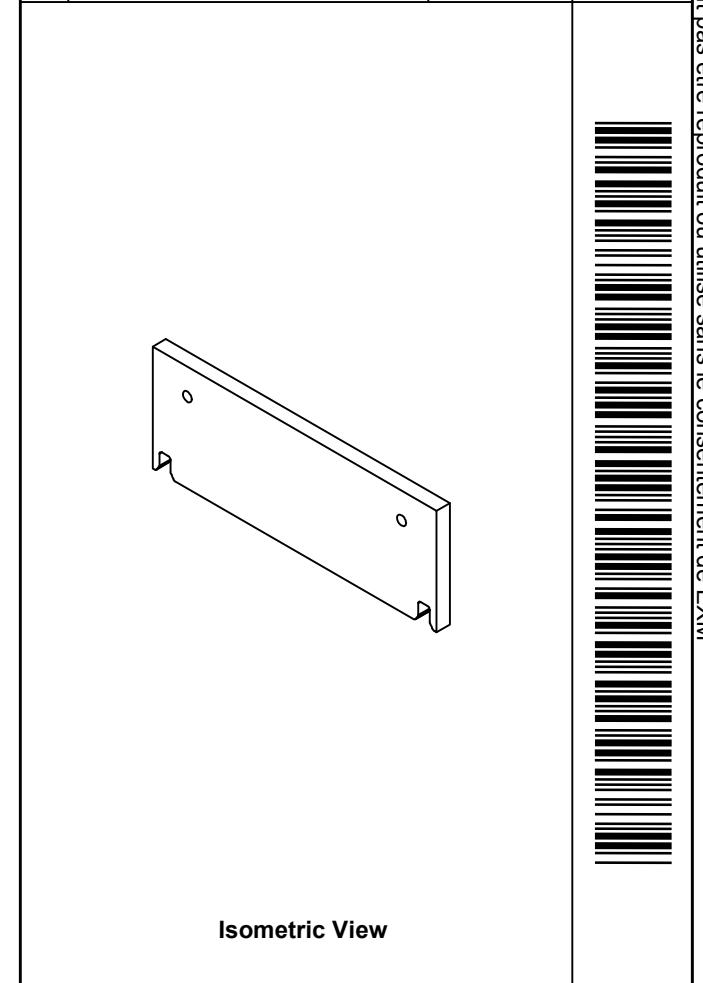

RIGHT

No.	Revisions	Date	By/Par

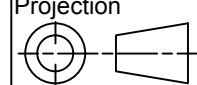

 Tél: (450) 979-4373 Fax: (450) 979-4626 <a href="http://www.exmweb.com">www.exmweb.com</a>		Flatness Aplatissement
		Max 3.0mm
Projection 		Date
Customer Client	Date	Date
Drawn By Dessiné Par	BoxCad: Patrick Deschenes	Date 23-Jan-07
Material Matière	Polyisocyanurate	
Color Couleur	Aluminum	Finish Fini N/A
Description	Detail Rev.	
5412ESW 30" x 16" Top and Bottom Insulation		
Part Number Numéro Pièce	Rev.	14
SEE BILL OF MATERIAL ON LAST PAGE	5412ESW301606THNOIPI-TP	0

This drawing is confidential and must not be reproduced or used without the consent of EXM

Ce dessin est confidentiel et ne doit pas être reproduit ou utilisé sans le consentement de EXM

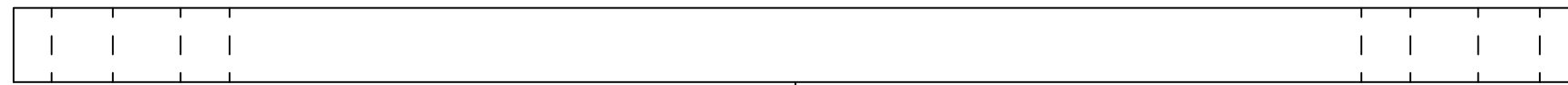

TOP

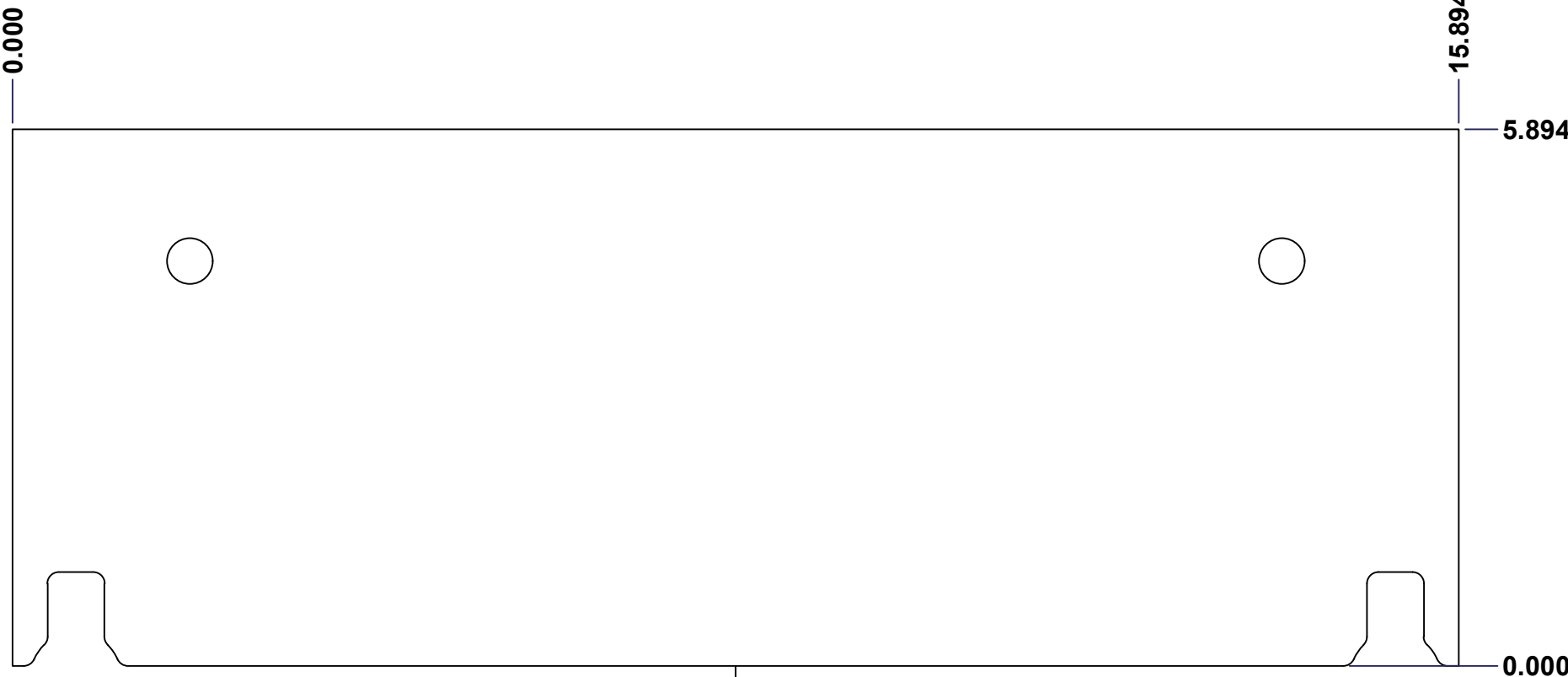

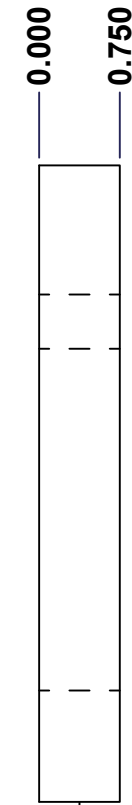

FRONT

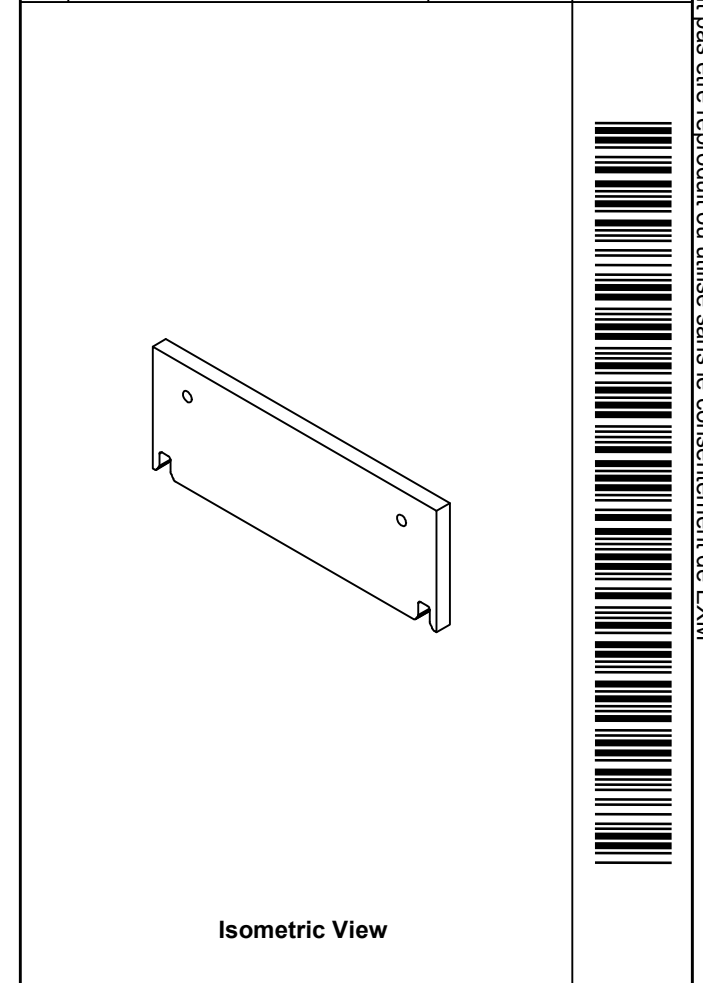

RIGHT

No.	Revisions	Date	By/Par



 Tél: (450) 979-4373 Fax: (450) 979-4626 <a href="http://www.exmweb.com">www.exmweb.com</a>		Flatness Aplatissement	
		Max 3.0mm	
Customer Client		Date	
Drawn By Dessiné Par		Date	
Material Matière		Polyisocyanurate	
Color Couleur		Finish Fini	
Aluminum		N/A	
Description			Detail Rev.
5412ESW 30" x 16" Top and Bottom Insulation			
Part Number Numéro Pièce		Rev.	15
SEE BILL OF MATERIAL ON LAST PAGE		5412ESW301606THNOIPI-BT	0

SEE BILL OF MATERIAL ON LAST PAGE 5412ESW301606THNOIPI-BT 0