

This drawing is confidential and must not be reproduced or used without the consent of EXM

Ce dessin est confidentiel et ne doit pas être reproduit ou utilisé sans le consentement de EXM

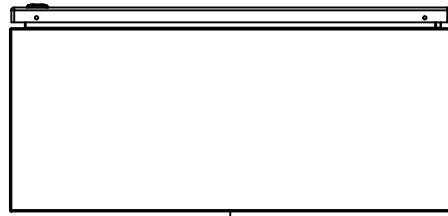

TOP

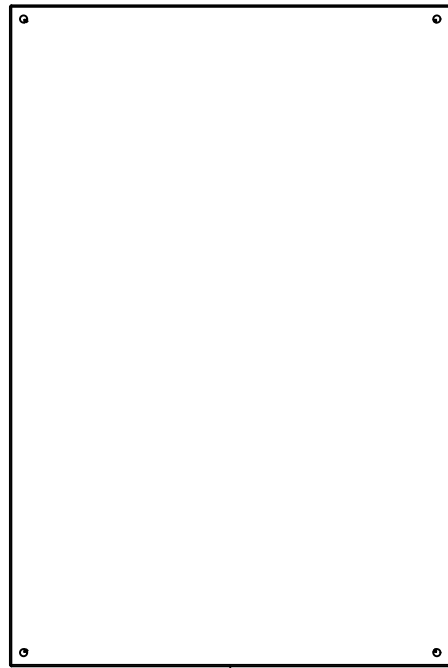

BACK

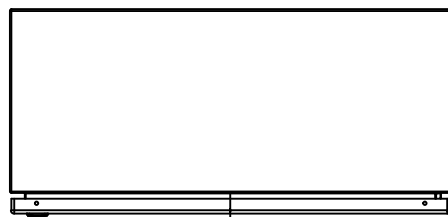

BOTTOM

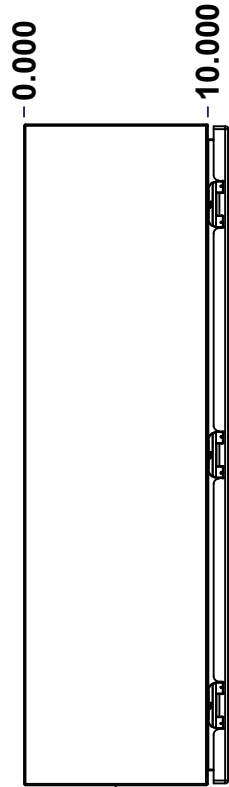

LEFT

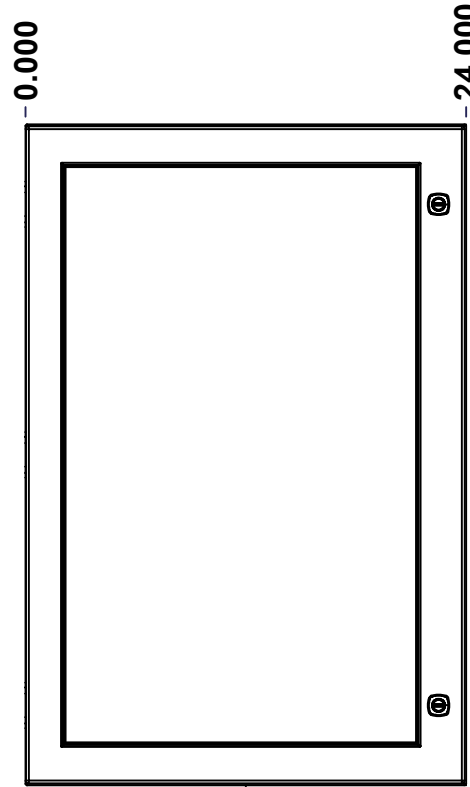

FRONT

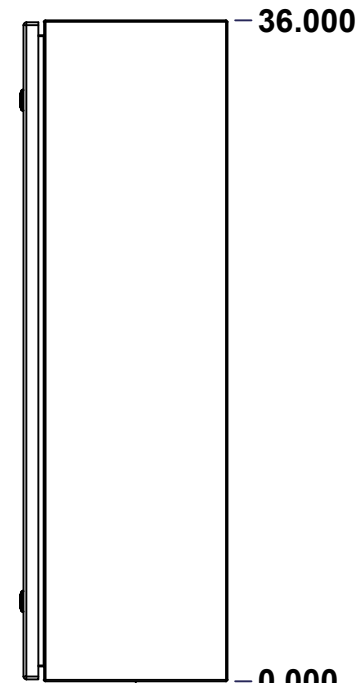

RIGHT

| No. | Revisions | Date | By/Par |
|-----|-----------|------|--------|
| | | | |
| | | | |
| | | | |
| | | | |
| | | | |

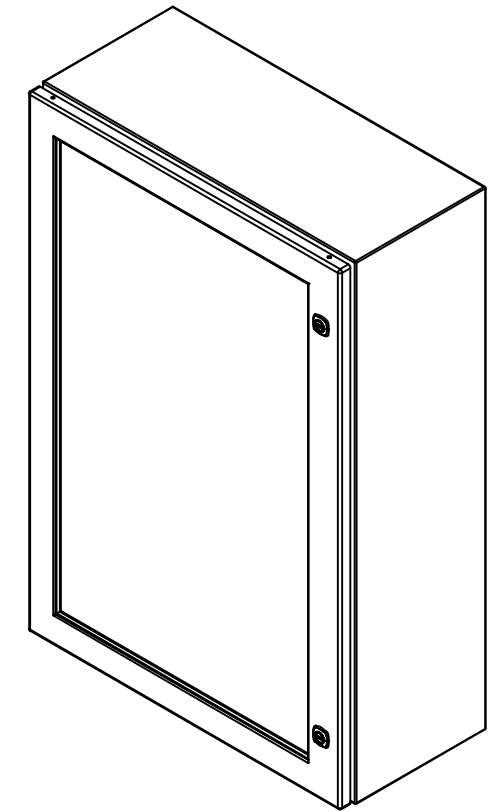

Isometric View



Tél: (450) 979-4373
 Fax: (450) 979-4626
www.exmweb.com

Flatness
Aplatissement

Max 3.0mm

Projection

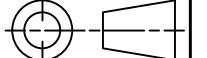

| | |
|---|-----------------------|
| Customer Client | Date |
| Drawn By Dessiné Par BoxCad: BoxCad | Date 14-Mar-23 |
| Material Matière 16 Ga Cold Rolled A1008 CS Type B (1.4mm) | |
| Color Couleur Asa-61 Grey | Finish Fini Smooth |
| Description 5412ESW 36" x 24" x 10" Assembly | Detail Rev. |
| Part Number Numéro Pièce 5412ESW362410NOIP | Rev. 0 |

SEE BILL OF MATERIAL ON LAST PAGE

1
9

This drawing is confidential and must not be reproduced or used without the consent of EXM

Ce dessin est confidentiel et ne doit pas être reproduit ou utilisé sans le consentement de EXM

| NOTE | |
|------|--|
| ITEM | DESCRIPTION |
| 1 | NEMA 4/12 Enclosure |
| 2 | C/W Standard ground studs on box and cover |
| 3 | W/O Standard door stiffener |
| 4 | W/O Inner panel |
| 5 | C/W Standard inner panel mounting studs |

| No. | Revisions | Date | By/Par |
|-----|-----------|------|--------|
| | | | |
| | | | |
| | | | |
| | | | |
| | | | |
| | | | |

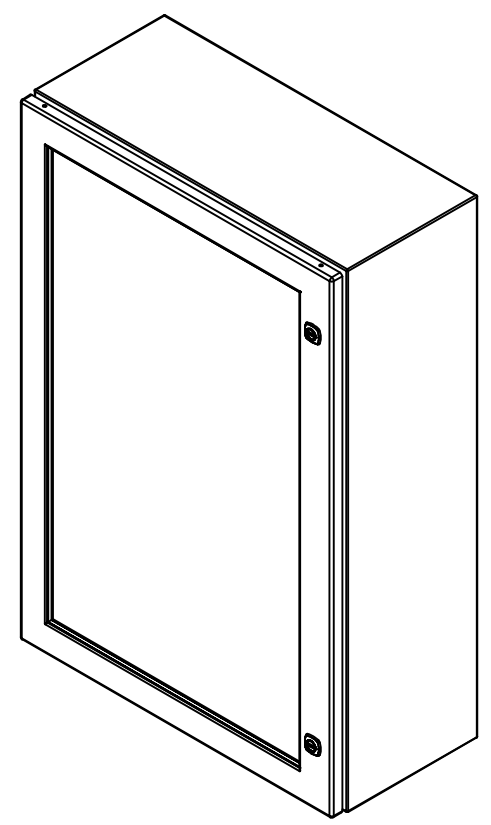

Isometric View

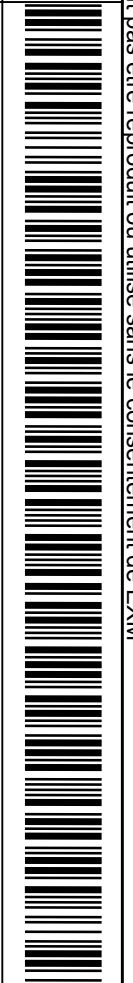

Tél: (450) 979-4373
 Fax: (450) 979-4626
www.exmweb.com

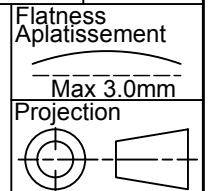

| | |
|---|-----------------|
| Customer Client | Date |
| Drawn By / Dessiné Par: BoxCad: BoxCad | Date: 14-Mar-23 |
| Material / Matière: 16 Ga Cold Rolled A1008 CS Type B (1.4mm) | |

| | |
|------------------------------|-----------------------|
| Color / Couleur: Asa-61 Grey | Finish / Fini: Smooth |
|------------------------------|-----------------------|

| | |
|---|-------------|
| Description: 5412ESW 36" x 24" x 10" Assembly | Detail Rev. |
|---|-------------|

| | | | |
|--|---------------|---|---|
| Part Number / Numéro Pièce: 5412ESW362410NOIP | Rev. 0 | 2 | 9 |
|--|---------------|---|---|

| PACKING | | |
|-----------------------|-----|--|
| ITEM | QTY | DESCRIPTION |
| Cardboard sleeve | 2 | Top and Bottom |
| Cardboard strip | 2 | Between back of enclosure and inner panel |
| Plastic bag | 1 | To protect cover surface and inside gasket |
| Plastic strap - Black | 2 | To Squeeze the 2 cardboard sleeve together |
| Packaging label | 1 | White label with product number |

| Qty | Part Number | Rev | Description |
|------------|--------------------|-----|--|
| 1 | STK-K-01800 | 5 | 5412 ES Accessory Kit |
| 1 | 5412ESW362410NOIPC | 0 | 5412ESW 36" x 24" Cover |
| 1 | 5412ESW362410NOIPB | 0 | 5412ESW 36" x 24" x 10" Body |
| 3 | STK-Q-04050-08 | 0 | M6 x 8mm Hexagon Socket Head Machine Screw |
| Parts List | | | |

This drawing is confidential and must not be reproduced or used without the consent of EXM

Ce dessin est confidentiel et ne doit pas être reproduit ou utilisé sans le consentement de EXM

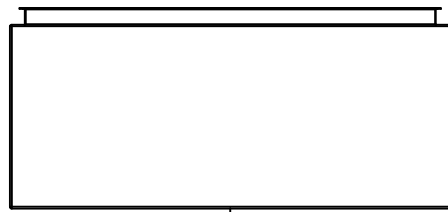

TOP

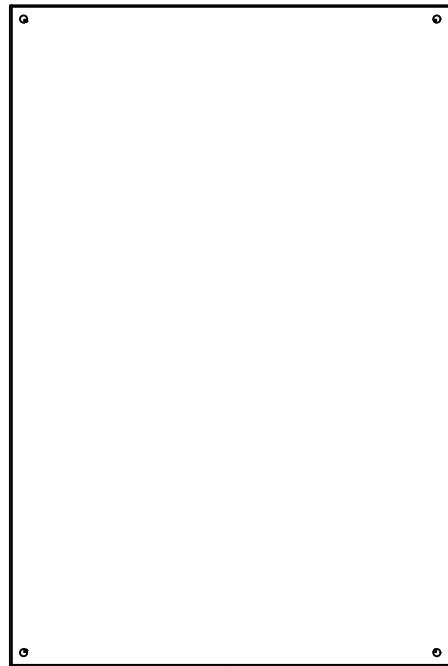

BACK

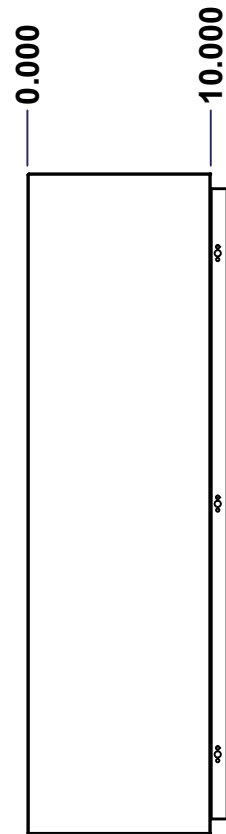

LEFT

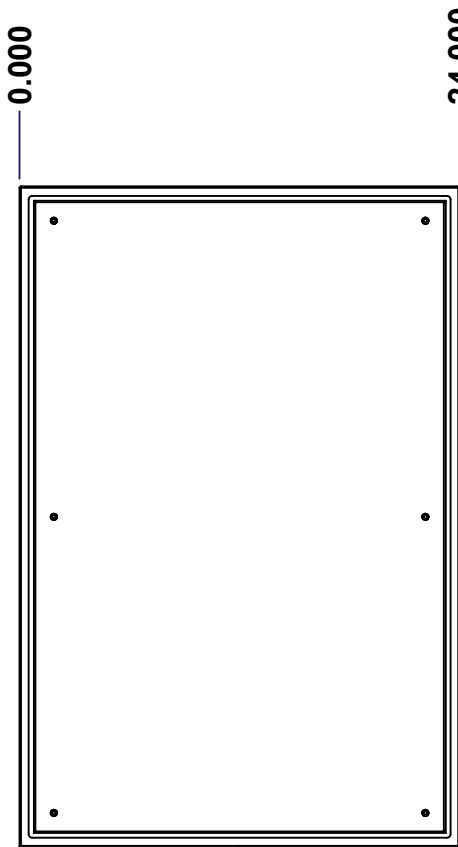

FRONT

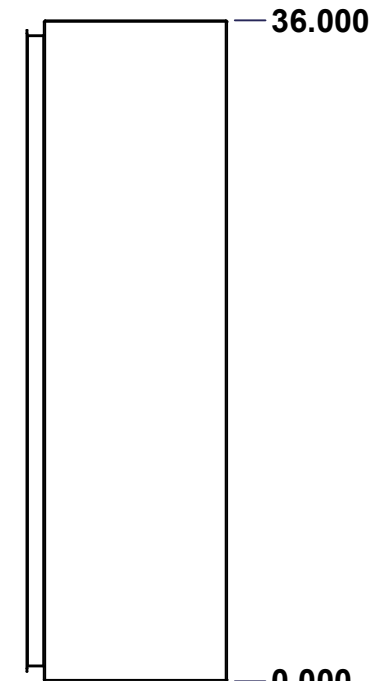

RIGHT



BOTTOM

| No. | Revisions | Date | By/Par |
|-----|-----------|------|--------|
| | | | |
| | | | |
| | | | |
| | | | |

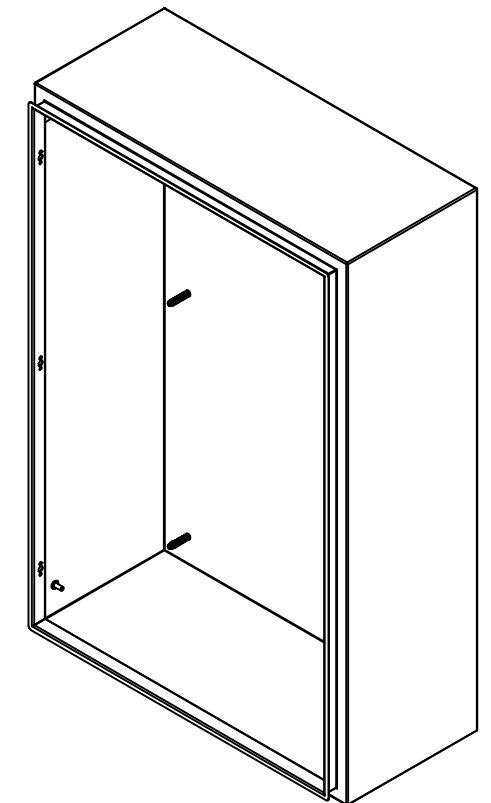

Isometric View

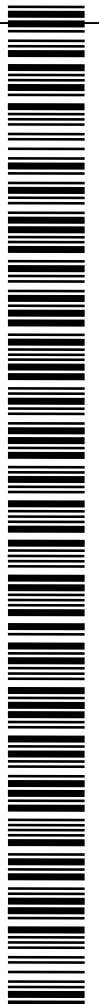

Tél: (450) 979-4373
 Fax: (450) 979-4626
www.exmweb.com

Flatness
Aplatissement

Max 3.0mm

Projection

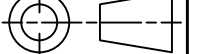

| | |
|---|-----------------------|
| Customer Client | Date |
| Drawn By Dessiné Par BoxCad: BoxCad | Date 14-Mar-23 |
| Material Matière 16 Ga Cold Rolled A1008 CS Type B (1.4mm) | |
| Color Couleur Asa-61 Grey | Finish Fini Smooth |
| Description 5412ESW 36" x 24" x 10" Body | Detail Rev. |
| Part Number Numéro Pièce 5412ESW362410NOIPB | Rev. 3 |
| | 0 |

SEE BILL OF MATERIAL ON LAST PAGE

This drawing is confidential and must not be reproduced or used without the consent of EXM

Ce dessin est confidentiel et ne doit pas être reproduit ou utilisé sans le consentement de EXM

| STANDARD FEATURES ARE NOT LISTED IN THIS HOLE TABLE | | | |
|---|-------|--------|-----------------------------|
| HOLE TABLE - LEFT VIEW (CUSTOM FEATURE ONLY) | | | |
| CUT-OUT | XDIM | YDIM | DESCRIPTION |
| 1 | 8.500 | 2.000 | GND STUD M6 x 16mm (Inside) |
| 2 | 8.000 | 34.000 | LABEL_EXM (Inside) |

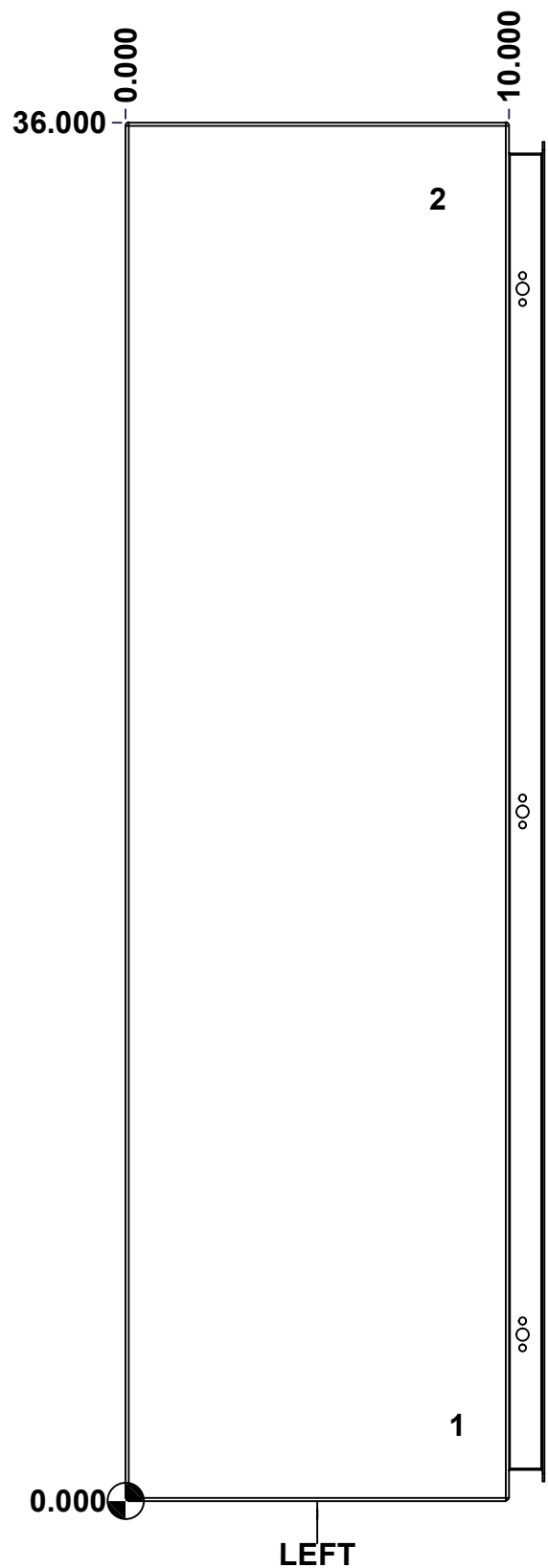

| | | | |
|--|------------------------------|----------|-----|
| | Description | Status | |
| | 5412ESW 36" x 24" x 10" Body | (NULL) | |
| | Part Number Numéro Pièce | Rev. | |
| | 5412ESW362410NOIPB | 0 | 4/9 |

This drawing is confidential and must not be reproduced or used without the consent of EXM

Ce dessin est confidentiel et ne doit pas être reproduit ou utilisé sans le consentement de EXM

STANDARD FEATURES ARE NOT LISTED IN THIS HOLE TABLE

HOLE TABLE - BACK VIEW (CUSTOM FEATURE ONLY)

| CUT-OUT | XDIM | YDIM | DESCRIPTION |
|---------|--------|--------|----------------------------|
| 1 | 1.875 | 1.875 | IP STUD M8 x 35mm (Inside) |
| 2 | 1.875 | 34.125 | IP STUD M8 x 35mm (Inside) |
| 3 | 22.125 | 34.125 | IP STUD M8 x 35mm (Inside) |
| 4 | 22.125 | 1.875 | IP STUD M8 x 35mm (Inside) |
| 5 | 1.875 | 18.000 | IP STUD M8 x 35mm (Inside) |
| 6 | 22.125 | 18.000 | IP STUD M8 x 35mm (Inside) |
| ----- | | | |
| 7 | 23.250 | 0.750 | RND Ø0.390 |
| 8 | 23.250 | 35.250 | RND Ø0.390 |
| 9 | 0.750 | 35.250 | RND Ø0.390 |
| 10 | 0.750 | 0.750 | RND Ø0.390 |

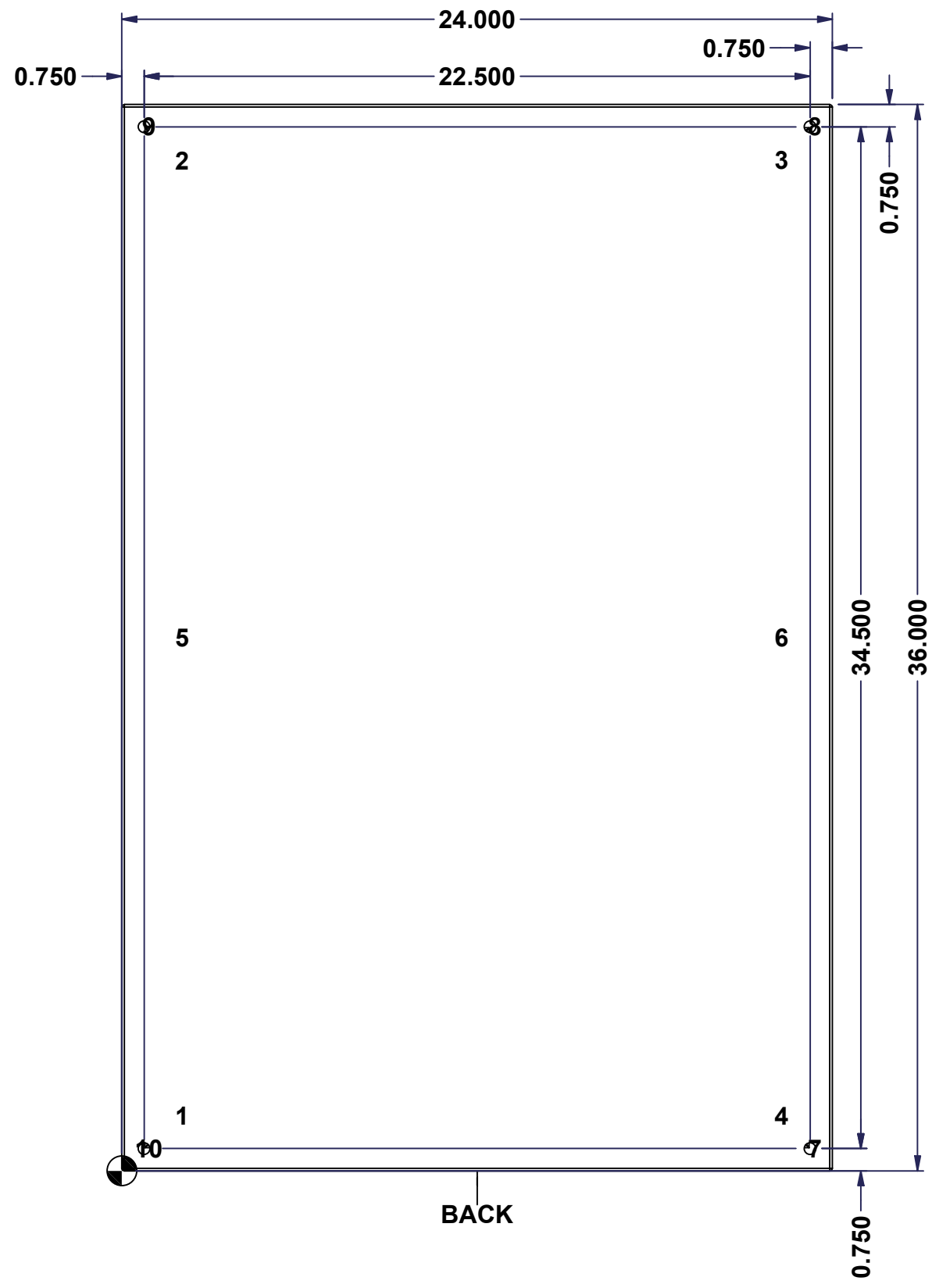

BACK

| | | | |
|--|------------------------------|----------|---|
| | Description | Status | |
| | 5412ESW 36" x 24" x 10" Body | (NULL) | |
| | Part Number | Rev. | 5 |
| | Numéro Pièce | 0 | 9 |
| | 5412ESW362410NOIPB | | |

This drawing is confidential and must not be reproduced or used without the consent of EXM

Ce dessin est confidentiel et ne doit pas être reproduit ou utilisé sans le consentement de EXM

| No. | Revisions | Date | By/Par |
|-----|-----------|------|--------|
| | | | |
| | | | |
| | | | |
| | | | |
| | | | |

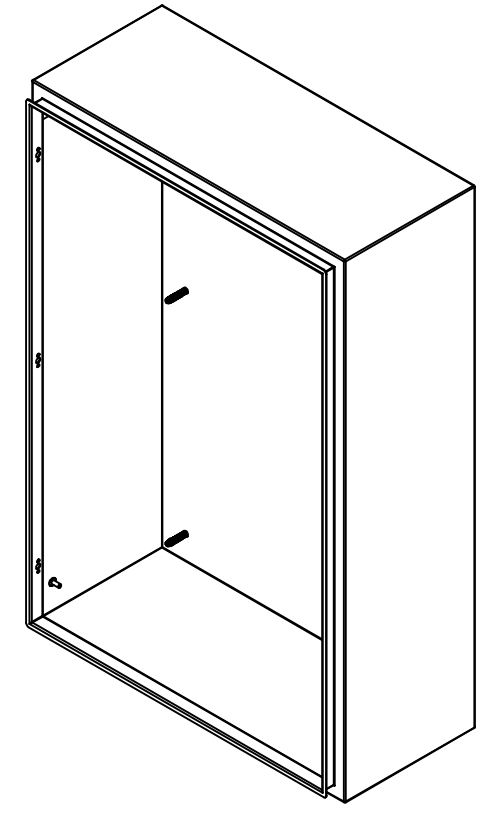

Isometric View



| | | |
|--|-----------------------|--|
|  Tél: (450) 979-4373 Fax: (450) 979-4626 www.exmweb.com | | Flatness Aplatissement Max 3.0mm |
| Customer Client | | Date |
| Drawn By Dessiné Par BoxCad: BoxCad | | Date 14-Mar-23 |
| Material Matière 16 Ga Cold Rolled A1008 CS Type B (1.4mm) | | |
| Color Couleur Asa-61 Grey | Finish Fini Smooth | |
| Description 5412ESW 36" x 24" x 10" Body | | Detail Rev. |
| Part Number Numéro Pièce 5412ESW362410NOIPB | | Rev. 6 0 |

| Qty | Part Number | Rev | Description |
|------------|----------------------|-----|--|
| 1 | STK-S-00100 | 0 | 3.5" x 2" Silver Milar Flexcon Sticker |
| 1 | STK-Q-16080 | 0 | Ground Stud M6 x 16mm Steel |
| 1 | STK-P-02400S | 0 | Powder Paint (Asa-61 Grey / Smooth) |
| 6 | STK-Q-16005 | 1 | Stud M8 x 35 (No Paint Cap Required) |
| 1 | 5412ESW362410NOIPB-P | 0 | 5412ESW 36" x 24" x 10" Body Part |
| Parts List | | | |

This drawing is confidential and must not be reproduced or used without the consent of EXM

Ce dessin est confidentiel et ne doit pas être reproduit ou utilisé sans le consentement de EXM

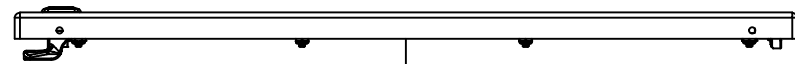

TOP

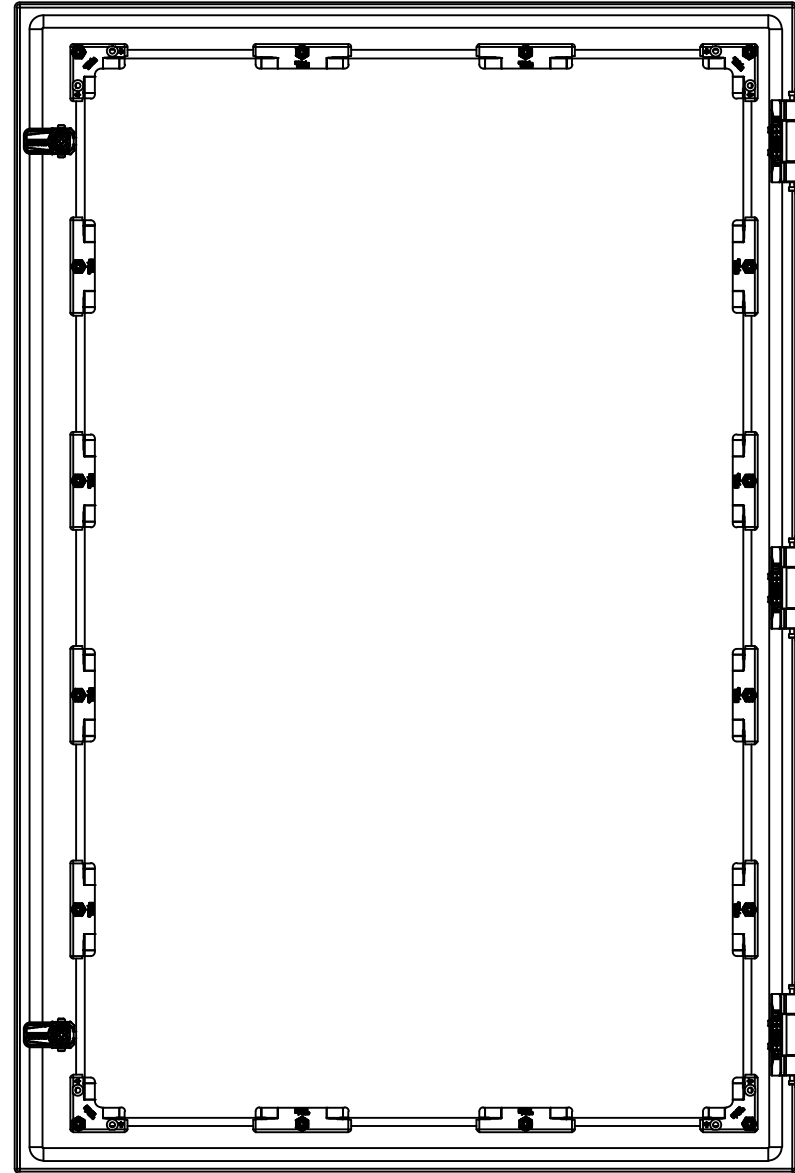

BACK

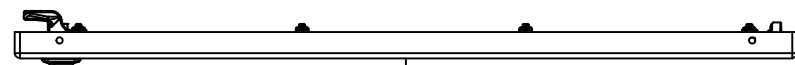

BOTTOM

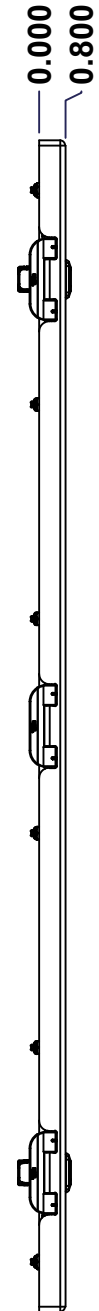

LEFT

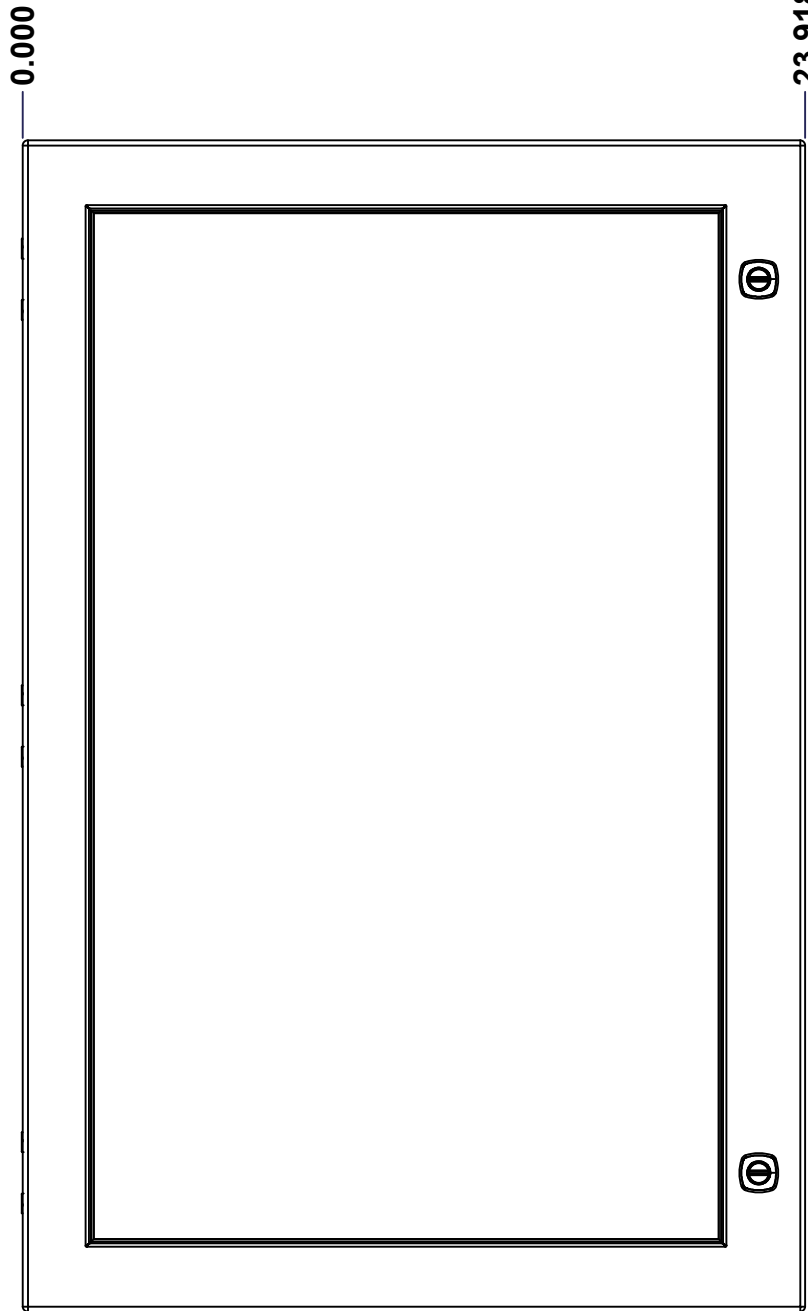

FRONT

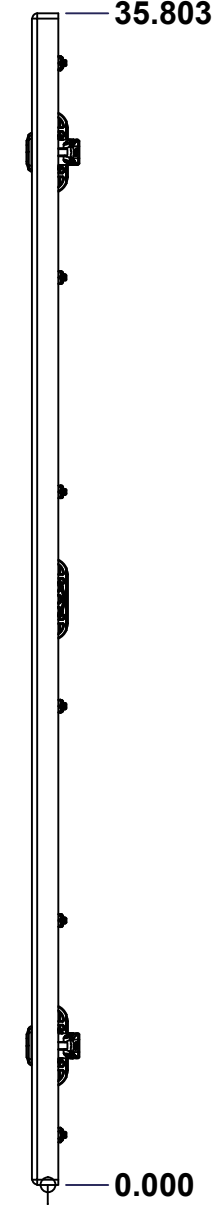

RIGHT

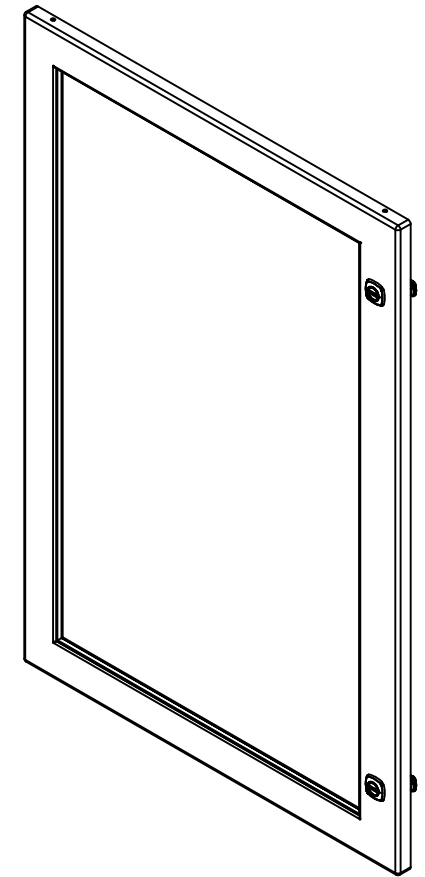

Isometric View

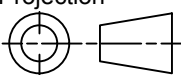

| No. | Revisions | Date | By/Par |
|-----|-----------|------|--------|
| | | | |
| | | | |
| | | | |
| | | | |

| | | |
|--|---|---|
|  Tél: (450) 979-4373 Fax: (450) 979-4626 www.exmweb.com | | Flatness Aplatissement Max 3.0mm Projection  |
| Customer Client | Date | |
| Drawn By Dessiné Par | BoxCad: BoxCad | Date 14-Mar-23 |
| Material Matière | 14 Ga Cold Rolled A1008 CS Type B (1.7mm) | |
| Color Couleur | Asa-61 Grey | Finish Fini Smooth |
| Description 5412ESW 36" x 24" Cover | | Detail Rev. |
| Part Number Numéro Pièce | Rev. 0 | 7 9 |

SEE BILL OF MATERIAL ON LAST PAGE

5412ESW362410NOIPC

This drawing is confidential and must not be reproduced or used without the consent of EXM

Ce dessin est confidentiel et ne doit pas être reproduit ou utilisé sans le consentement de EXM

STANDARD FEATURES ARE NOT LISTED IN THIS HOLE TABLE

HOLE TABLE - FRONT VIEW (CUSTOM FEATURE ONLY)

| CUT-OUT | XDIM | YDIM | DESCRIPTION |
|---------|--------|--------|-------------------------|
| 1 | 1.469 | 8.077 | STUD M6 x 18mm (Inside) |
| 2 | 21.968 | 8.077 | STUD M6 x 18mm (Inside) |
| 3 | 1.469 | 14.627 | STUD M6 x 18mm (Inside) |
| 4 | 21.968 | 14.627 | STUD M6 x 18mm (Inside) |
| 5 | 1.469 | 21.176 | STUD M6 x 18mm (Inside) |
| 6 | 21.968 | 21.176 | STUD M6 x 18mm (Inside) |
| 7 | 1.469 | 27.726 | STUD M6 x 18mm (Inside) |
| 8 | 21.968 | 27.726 | STUD M6 x 18mm (Inside) |
| 9 | 1.469 | 34.276 | STUD M6 x 18mm (Inside) |
| 10 | 1.469 | 1.527 | STUD M6 x 18mm (Inside) |
| 11 | 8.302 | 34.276 | STUD M6 x 18mm (Inside) |
| 12 | 8.302 | 1.527 | STUD M6 x 18mm (Inside) |
| 13 | 15.135 | 34.276 | STUD M6 x 18mm (Inside) |
| 14 | 15.135 | 1.527 | STUD M6 x 18mm (Inside) |
| 15 | 21.968 | 34.276 | STUD M6 x 18mm (Inside) |
| 16 | 21.968 | 1.527 | STUD M6 x 18mm (Inside) |
| ----- | | | |
| 17 | 22.494 | 31.553 | 880 SCQ4-SL |
| 18 | 22.494 | 4.250 | 880 SCQ4-SL |

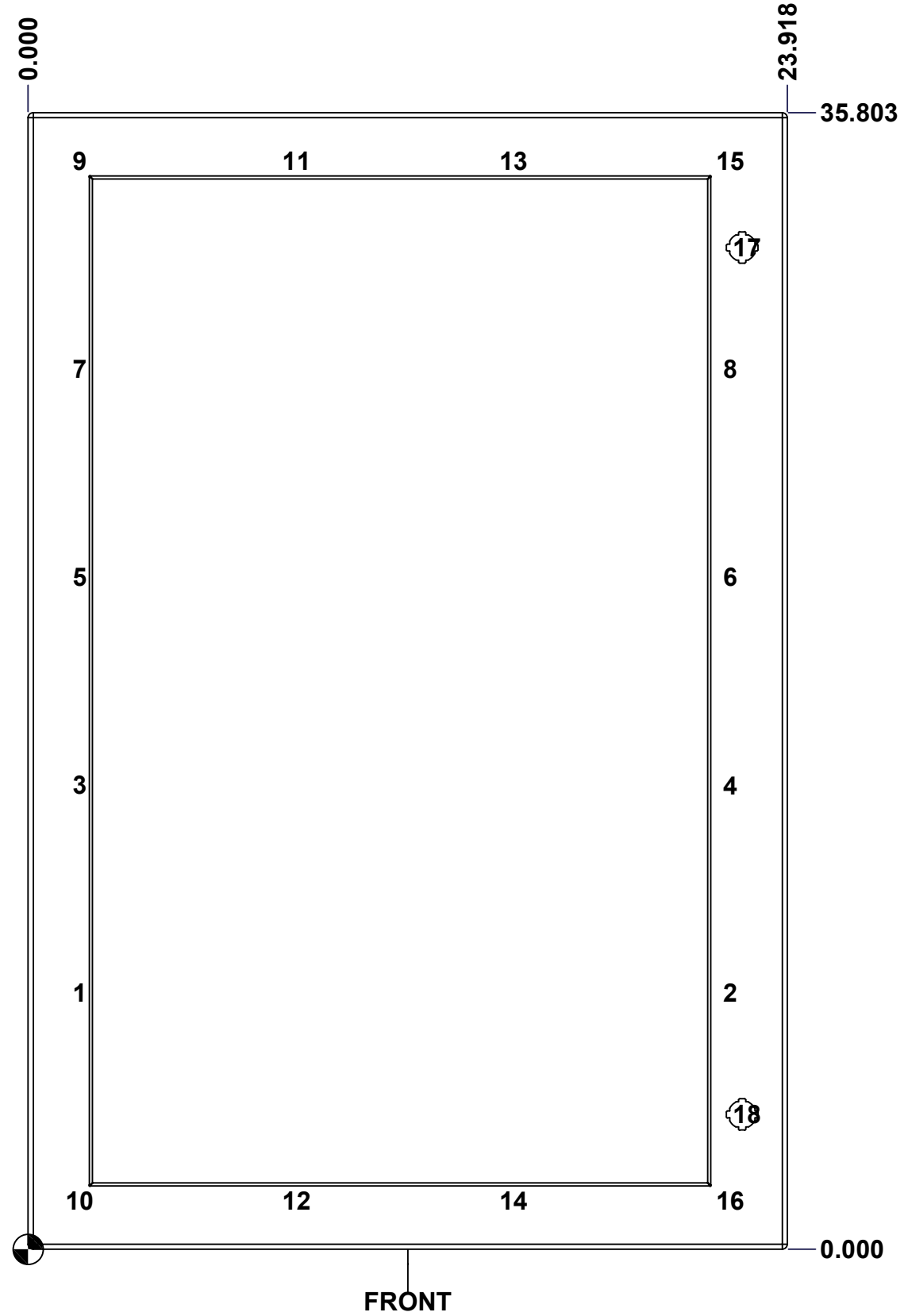

| | | |
|--|-------------------------|--------|
| | Description | Status |
| | 5412ESW 36" x 24" Cover | (NULL) |
| Part Number Numéro Pièce 5412ESW362410NOIPC | Rev. | 8 |
| | 0 | 9 |

This drawing is confidential and must not be reproduced or used without the consent of EXM

Ce dessin est confidentiel et ne doit pas être reproduit ou utilisé sans le consentement de EXM

| No. | Revisions | Date | By/Par |
|-----|-----------|------|--------|
| | | | |
| | | | |
| | | | |
| | | | |
| | | | |

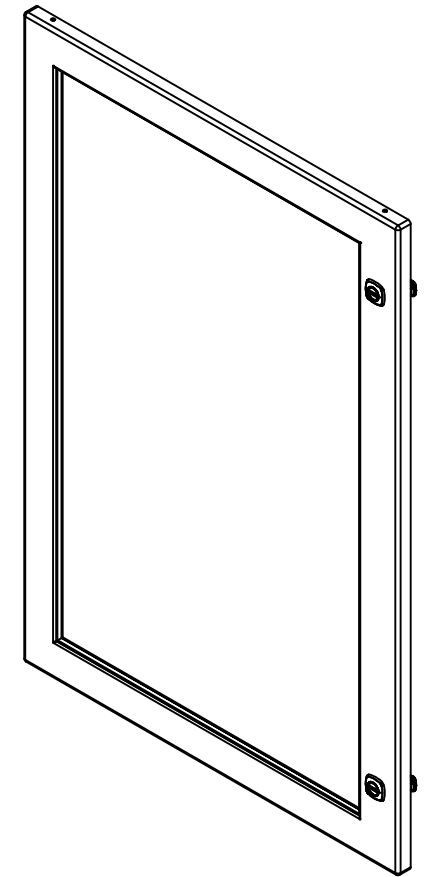

Isometric View

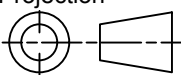

| Qty | Part Name | Rev | Description |
|------------|-----------------------|-----|---|
| 1 | STK-P-02400S | 0 | Powder Paint (Asa-61 Grey / Smooth) |
| 12 | STK-Q-60701 | 2.1 | 880 WK - Lexan 1/4" Fixing Bracket |
| 1 | STK-A-60703 | 0 | 5412 ESW Lexan Bracket Kit |
| 16 | STK-Q-16052 | 0 | M6 x 23mm Stud (No Paint Cap Required) |
| 1 | STK-G-02710 | 0 | 880 HWKG - Windows Kit Gasket |
| 1 | 5412ESW362410NOIPLX G | 0 | 5412ESW 36" x 24" Lexan Gasket Part |
| 1 | 5412ESW362410NOIPLX | 0 | 5412ESW 32.375" x 20.125" Lexan Part |
| 1 | 5412ESW362410NOIPG | 0 | 5412ESW 36" x 24" Cover Gasket Part |
| 1 | 5412ESW362410NOIPC-P | 0 | 5412ESW 36" x 24" Cover Part |
| 3 | STK-K-09800 | 10 | 5412 ES Hinge with 2 Captive Hinge Pins |
| 2 | STK-K-12500 | 16 | 5412 ES 1/4 Turn Lock |
| Parts List | | | |

| | | |
|--|---|---|
|  Tél: (450) 979-4373 Fax: (450) 979-4626 www.exmweb.com | | Flatness Aplatissement Max 3.0mm Projection  |
| Customer Client | Date | |
| Drawn By Dessiné Par | BoxCad: BoxCad | Date 14-Mar-23 |
| Material Matière | 14 Ga Cold Rolled A1008 CS Type B (1.7mm) | |
| Color Couleur | Asa-61 Grey | Finish Fini Smooth |
| Description | | Detail Rev. |
| 5412ESW 36" x 24" Cover | | |
| Part Number Numéro Pièce | Rev. | 9 |
| 5412ESW362410NOIPC | 0 | 9 |