

This drawing is confidential and must not be reproduced or used without the consent of EXM

Ce dessin est confidentiel et ne doit pas être reproduit ou utilisé sans le consentement de EXM

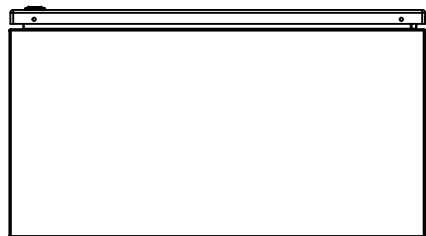

TOP

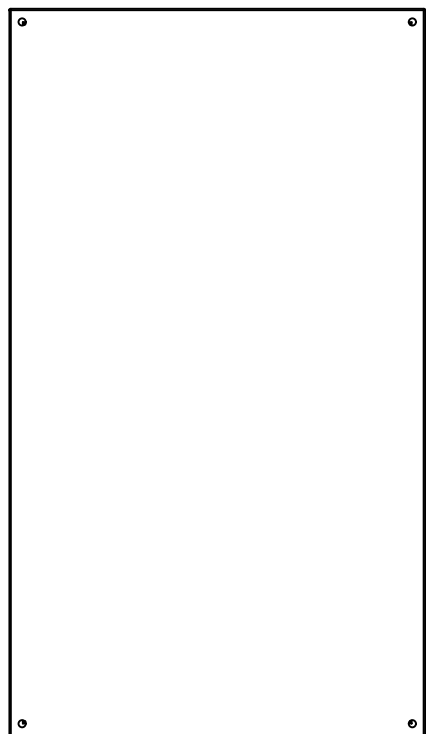

BACK

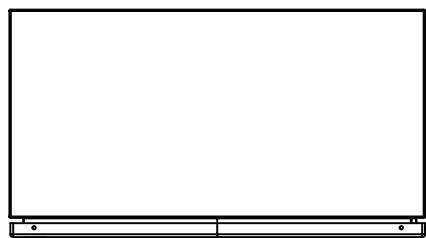

BOTTOM

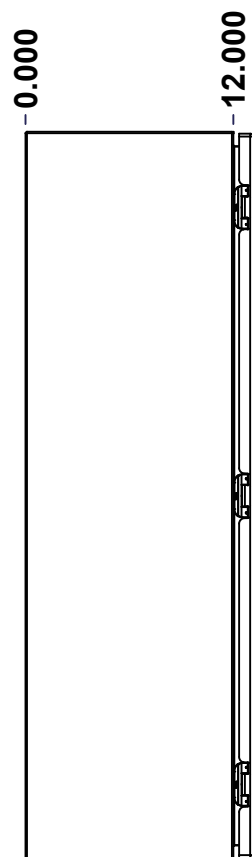

LEFT

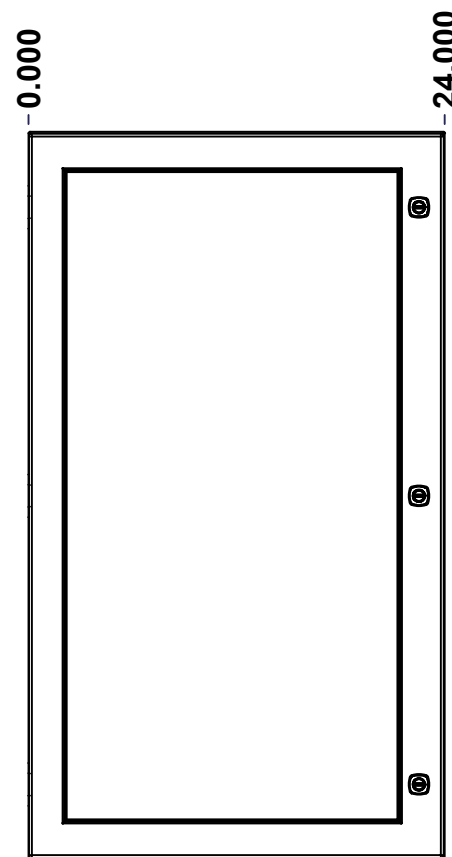

FRONT

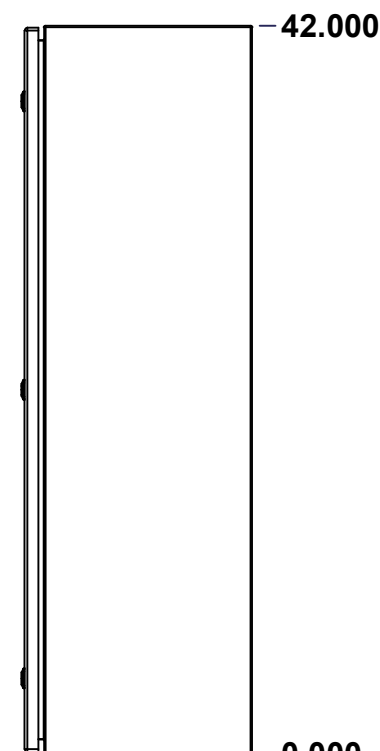

RIGHT

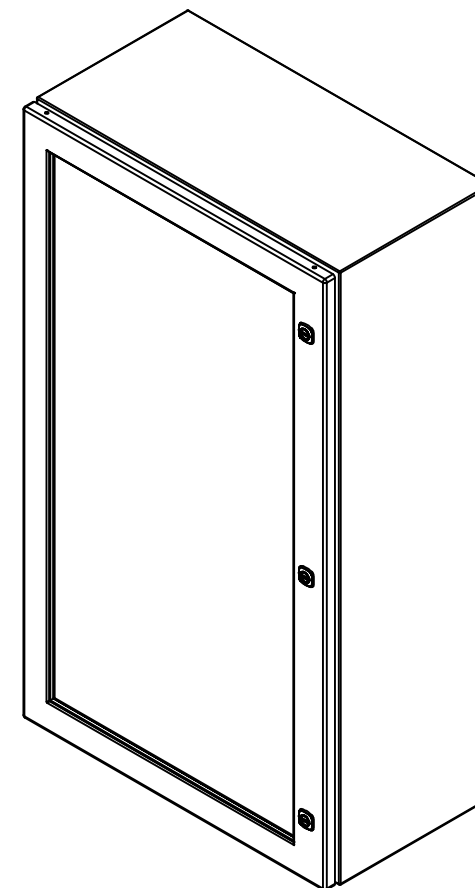

Isometric View

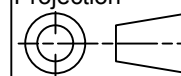

| No. | Revisions | Date | By/Par |
|-----|-----------|------|--------|
|     |           |      |        |
|     |           |      |        |
|     |           |      |        |
|     |           |      |        |
|     |           |      |        |

|  |   |   |
|--|---|---|
|  Tél: (450) 979-4373<br>Fax: (450) 979-4626<br><a href="http://www.exmweb.com">www.exmweb.com</a> |   | Flatness<br>Aplatissement<br>Max 3.0mm<br>Projection<br> |
| Customer Client  | Date                                      |   |
| Drawn By<br>Dessiné Par  | BoxCad: BoxCad                            | Date 14-Mar-23  |
| Material<br>Matière  | 16 Ga Cold Rolled A1008 CS Type B (1.4mm) |   |
| Color<br>Couleur   | Asa-61 Grey                               | Finish<br>Fini Smooth   |
| Description  | Detail Rev.                               |   |
| 5412ESW 42" x 24" x 12" Assembly   |   |   |
| Part Number<br>Numéro Pièce  | Rev.                                      | 1   |
| 5412ESW422412NOIP  | 0   | 9   |

SEE BILL OF MATERIAL ON LAST PAGE

This drawing is confidential and must not be reproduced or used without the consent of EXM

Ce dessin est confidentiel et ne doit pas être reproduit ou utilisé sans le consentement de EXM

| NOTE |  |
|------|--|
| ITEM | DESCRIPTION                                |
| 1    | NEMA 4/12 Enclosure                        |
| 2    | C/W Standard ground studs on box and cover |
| 3    | W/O Standard door stiffener                |
| 4    | W/O Inner panel                            |
| 5    | C/W Standard inner panel mounting studs    |

| No. | Revisions | Date | By/Par |
|-----|-----------|------|--------|
|     |           |      |        |
|     |           |      |        |
|     |           |      |        |
|     |           |      |        |
|     |           |      |        |
|     |           |      |        |

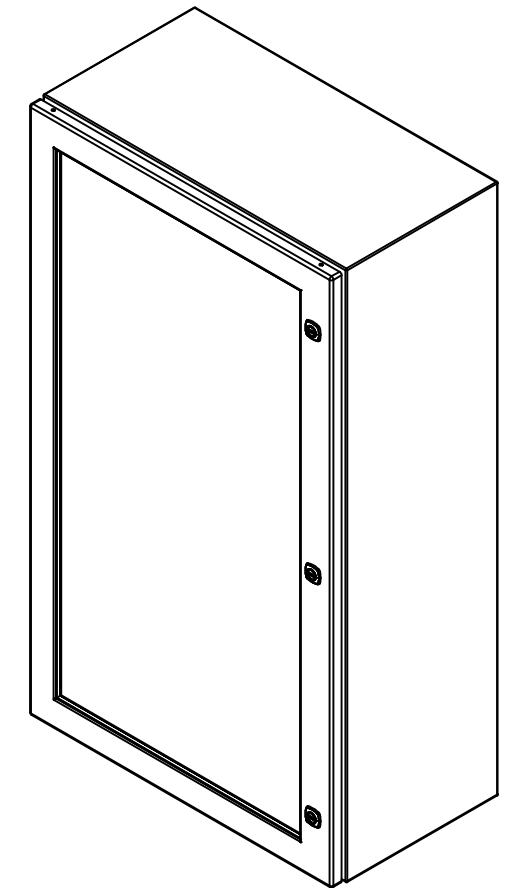

Isometric View



| PACKING               |     |  |
|-----------------------|-----|--|
| ITEM                  | QTY | DESCRIPTION                                    |
| Cardboard sleeve      | 2   | Top and Bottom                                 |
| Cardboard strip       | 2   | Between back of enclosure and inner panel      |
| Plastic bag           | 1   | To protect cover surface and inside gasket     |
| Cardboard corner      | 4   | To reinforced for the plastic strap tightening |
| Plastic strap - Black | 2   | To Squeeze the 2 cardboard sleeve together     |
| Packaging label       | 3   | White label with PN                            |
| Plastic strap- Green  | 2   | To secure the enclosure to the wood pallet     |
| Wood Pallet           | 1   | 2" deeper and 3" larger than enclosure size    |

|            |                    |     |  |
|------------|--------------------|-----|--|
| 1          | STK-K-01800        | 5   | 5412 ES Accessory Kit                      |
| 1          | 5412ESW422412NOIPC | 0   | 5412ESW 42" x 24" Cover                    |
| 1          | 5412ESW422412NOIPB | 0   | 5412ESW 42" x 24" x 12" Body               |
| 3          | STK-Q-04050-08     | 0   | M6 x 8mm Hexagon Socket Head Machine Screw |
| Qty        | Part Number        | Rev | Description                                |
| Parts List |                    |     |  |

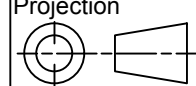
|  |   |
|--|---|
|  Tél: (450) 979-4373<br>Fax: (450) 979-4626<br><a href="http://www.exmweb.com">www.exmweb.com</a> | Flatness<br>Aplatissement<br>Max 3.0mm  |
|  | Projection<br> |
| Customer Client  | Date  |
| Drawn By<br>Dessiné Par BoxCad: BoxCad   | Date 14-Mar-23  |
| Material<br>Matière 16 Ga Cold Rolled A1008 CS Type B (1.4mm)  |   |
| Color<br>Couleur Asa-61 Grey   | Finish<br>Fini Smooth   |
| Description<br>5412ESW 42" x 24" x 12" Assembly  | Detail Rev.   |
| Part Number<br>Numéro Pièce<br><b>5412ESW422412NOIP</b>  | Rev. <b>0</b>   |
|  | 2<br>9  |

This drawing is confidential and must not be reproduced or used without the consent of EXM

Ce dessin est confidentiel et ne doit pas être reproduit ou utilisé sans le consentement de EXM

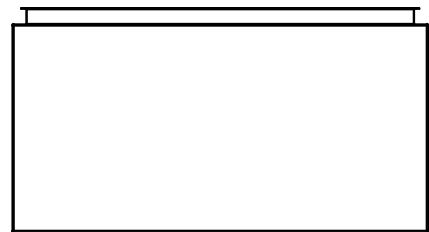

TOP

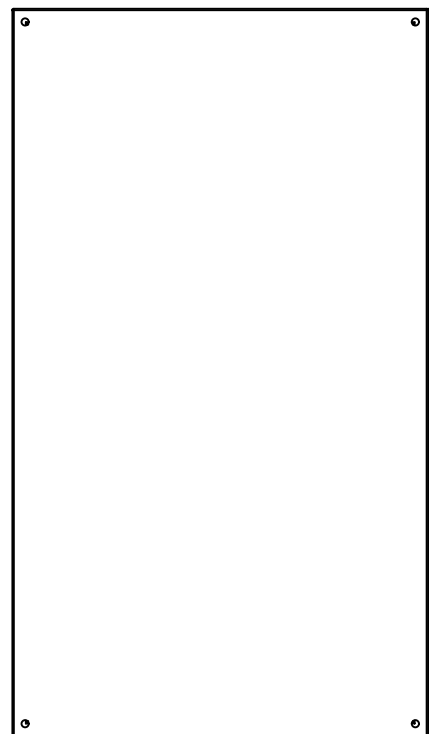

BACK



BOTTOM

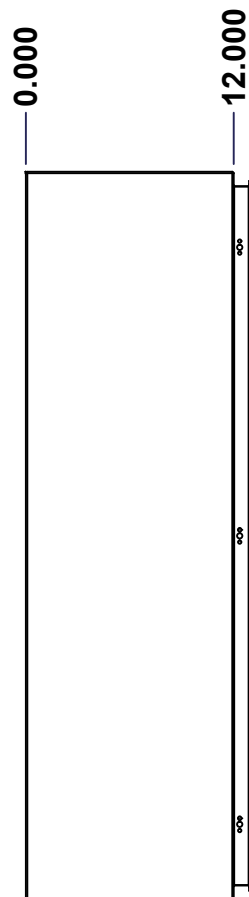

LEFT

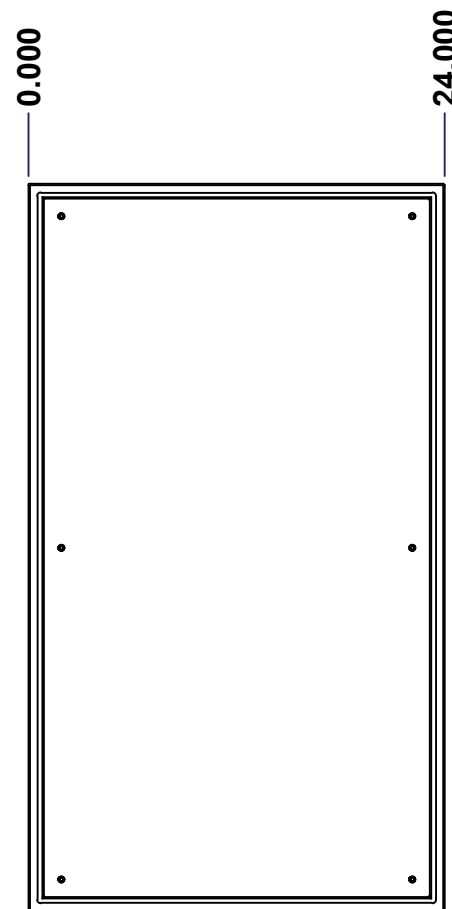

FRONT

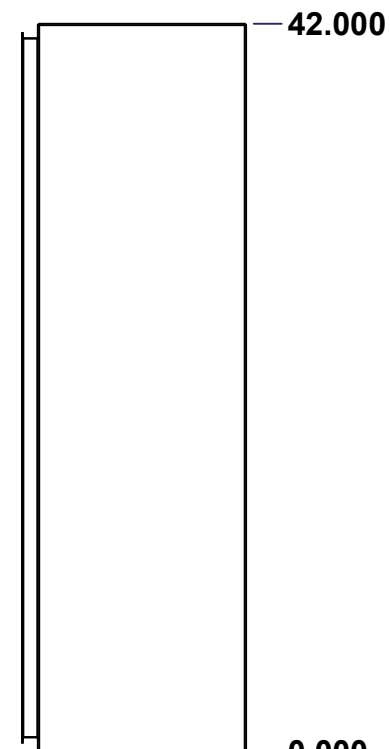

RIGHT

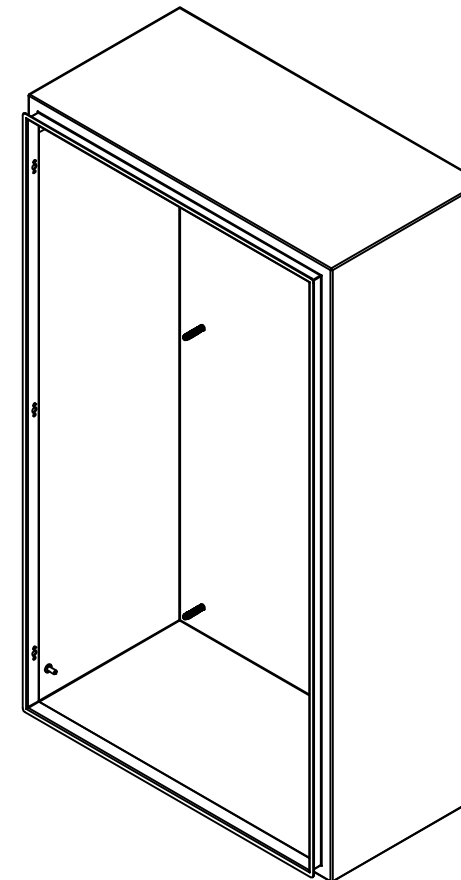

Isometric View

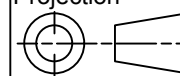

| No. | Revisions | Date | By/Par |
|-----|-----------|------|--------|
|     |           |      |        |
|     |           |      |        |
|     |           |      |        |
|     |           |      |        |
|     |           |      |        |

|  |   |   |
|--|---|---|
|  Tél: (450) 979-4373<br>Fax: (450) 979-4626<br><a href="http://www.exmweb.com">www.exmweb.com</a> |   | Flatness<br>Aplatissement<br>Max 3.0mm<br>Projection<br> |
| Customer Client  | Date                                      |   |
| Drawn By<br>Dessiné Par  | BoxCad: BoxCad                            | Date 14-Mar-23  |
| Material<br>Matière  | 16 Ga Cold Rolled A1008 CS Type B (1.4mm) |   |
| Color<br>Couleur   | Asa-61 Grey                               | Finish<br>Fini Smooth   |
| Description  | Detail Rev.                               |   |
| 5412ESW 42" x 24" x 12" Body   |   |   |
| Part Number<br>Numéro Pièce  | Rev. 0                                    | 3<br>9  |

SEE BILL OF MATERIAL ON LAST PAGE **5412ESW422412NOIPB**

This drawing is confidential and must not be reproduced or used without the consent of EXM

Ce dessin est confidentiel et ne doit pas être reproduit ou utilisé sans le consentement de EXM

| STANDARD FEATURES ARE NOT LISTED IN THIS HOLE TABLE |        |        |                             |
|---|--------|--------|-----------------------------|
| HOLE TABLE - LEFT VIEW (CUSTOM FEATURE ONLY)        |        |        |                             |
| CUT-OUT   | XDIM   | YDIM   | DESCRIPTION                 |
| 1   | 10.500 | 2.000  | GND STUD M6 x 16mm (Inside) |
| 2   | 10.000 | 40.000 | LABEL_EXM (Inside)          |

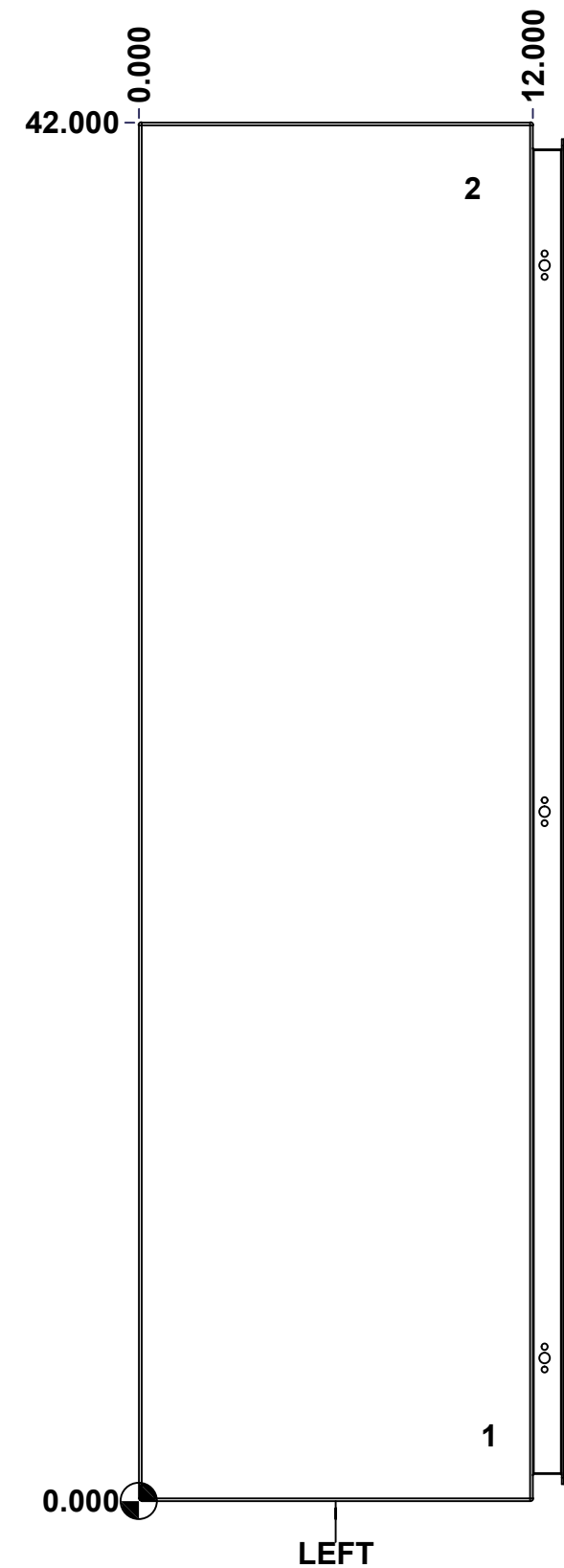

|  |                              |          |     |
|--|------------------------------|----------|-----|
|  | Description                  | Status   |     |
|  | 5412ESW 42" x 24" x 12" Body | (NULL)   |     |
|  | Part Number<br>Numéro Pièce  | Rev.     |     |
|  | <b>5412ESW422412NOIPB</b>    | <b>0</b> | 4/9 |

This drawing is confidential and must not be reproduced or used without the consent of EXM

Ce dessin est confidentiel et ne doit pas être reproduit ou utilisé sans le consentement de EXM

**STANDARD FEATURES ARE NOT LISTED IN THIS HOLE TABLE**

**HOLE TABLE - BACK VIEW (CUSTOM FEATURE ONLY)**

| CUT-OUT | XDIM   | YDIM   | DESCRIPTION                |
|---------|--------|--------|----------------------------|
| 1       | 1.875  | 1.875  | IP STUD M8 x 35mm (Inside) |
| 2       | 1.875  | 40.125 | IP STUD M8 x 35mm (Inside) |
| 3       | 22.125 | 40.125 | IP STUD M8 x 35mm (Inside) |
| 4       | 22.125 | 1.875  | IP STUD M8 x 35mm (Inside) |
| 5       | 1.875  | 21.000 | IP STUD M8 x 35mm (Inside) |
| 6       | 22.125 | 21.000 | IP STUD M8 x 35mm (Inside) |
| -----   |        |        |                            |
| 7       | 23.250 | 0.750  | RND Ø0.390                 |
| 8       | 23.250 | 41.250 | RND Ø0.390                 |
| 9       | 0.750  | 41.250 | RND Ø0.390                 |
| 10      | 0.750  | 0.750  | RND Ø0.390                 |

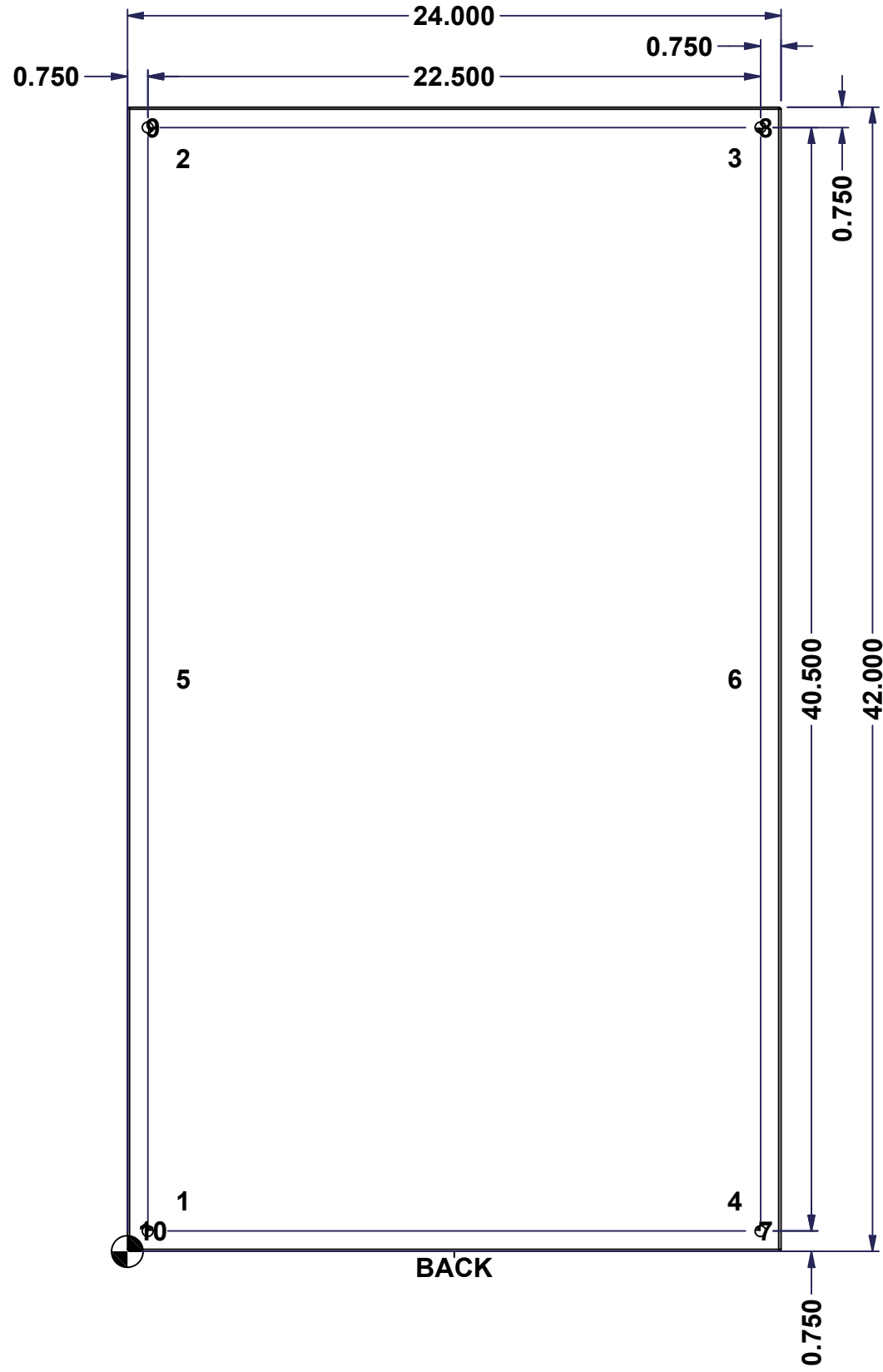

|  |                              |          |   |
|--|------------------------------|----------|---|
|  | Description                  | Status   |   |
|  | 5412ESW 42" x 24" x 12" Body | (NULL)   |   |
|  | Part Number<br>Numéro Pièce  | Rev.     | 5 |
|  | <b>5412ESW422412NOIPB</b>    | <b>0</b> | 9 |

This drawing is confidential and must not be reproduced or used without the consent of EXM

Ce dessin est confidentiel et ne doit pas être reproduit ou utilisé sans le consentement de EXM

| No. | Revisions | Date | By/Par |
|-----|-----------|------|--------|
|     |           |      |        |
|     |           |      |        |
|     |           |      |        |
|     |           |      |        |
|     |           |      |        |

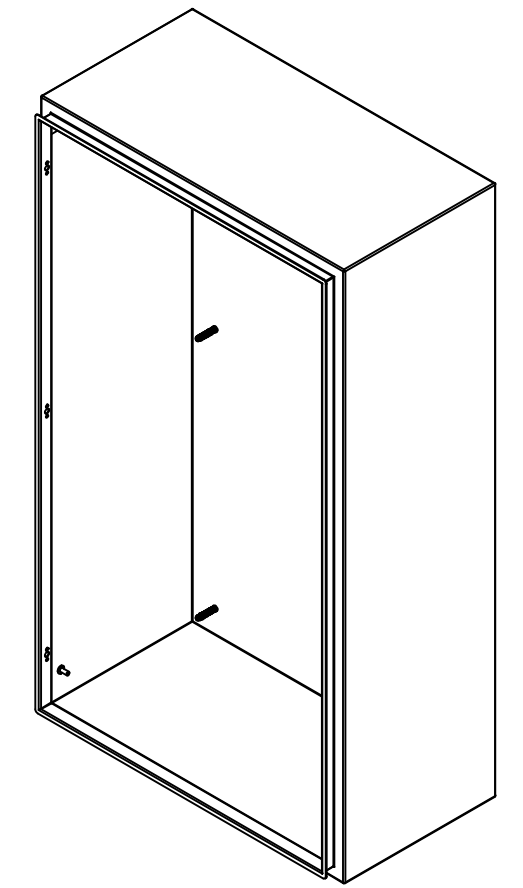

Isometric View

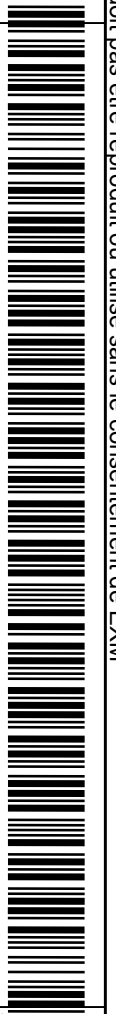

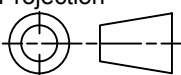
|  |   |   |
|--|---|---|
|  Tél: (450) 979-4373<br>Fax: (450) 979-4626<br><a href="http://www.exmweb.com">www.exmweb.com</a> |   | Flatness<br>Aplatissement<br>Max 3.0mm<br>Projection<br> |
| Customer Client  | Date                                      |   |
| Drawn By<br>Dessiné Par  | BoxCad: BoxCad                            | Date 14-Mar-23  |
| Material<br>Matière  | 16 Ga Cold Rolled A1008 CS Type B (1.4mm) |   |
| Color<br>Couleur   | Asa-61 Grey                               | Finish<br>Fini Smooth   |
| Description  |   | Detail Rev.   |
| 5412ESW 42" x 24" x 12" Body   |   |   |
| Part Number<br>Numéro Pièce  | Rev. 0                                    | 6 / 9   |
| <b>5412ESW422412NOIPB</b>  |   |   |

| Qty        | Part Number          | Rev | Description                            |
|------------|----------------------|-----|--|
| 1          | STK-S-00100          | 0   | 3.5" x 2" Silver Milar Flexcon Sticker |
| 1          | STK-Q-16080          | 0   | Ground Stud M6 x 16mm Steel            |
| 1          | STK-P-02400S         | 0   | Powder Paint (Asa-61 Grey / Smooth)    |
| 6          | STK-Q-16005          | 1   | Stud M8 x 35 (No Paint Cap Required)   |
| 1          | 5412ESW422412NOIPB-P | 0   | 5412ESW 42" x 24" x 12" Body Part      |
| Parts List |                      |     |  |

This drawing is confidential and must not be reproduced or used without the consent of EXM

Ce dessin est confidentiel et ne doit pas être reproduit ou utilisé sans le consentement de EXM

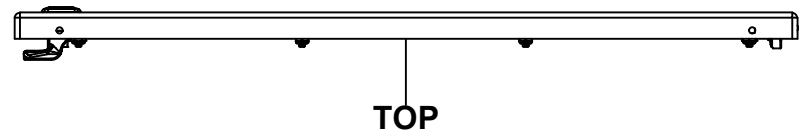

TOP

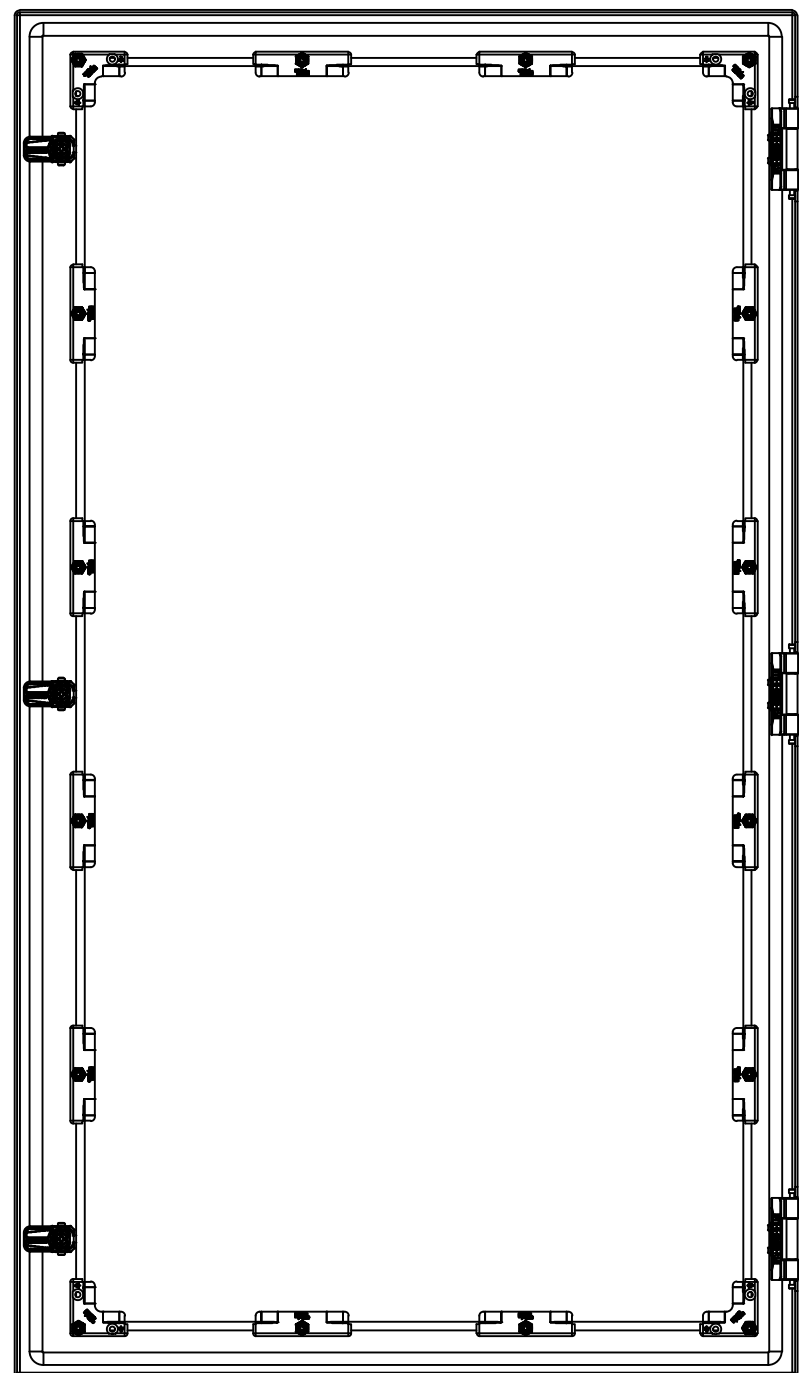

BACK



BOTTOM

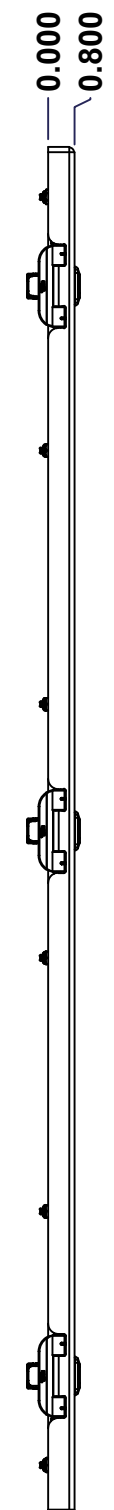

LEFT

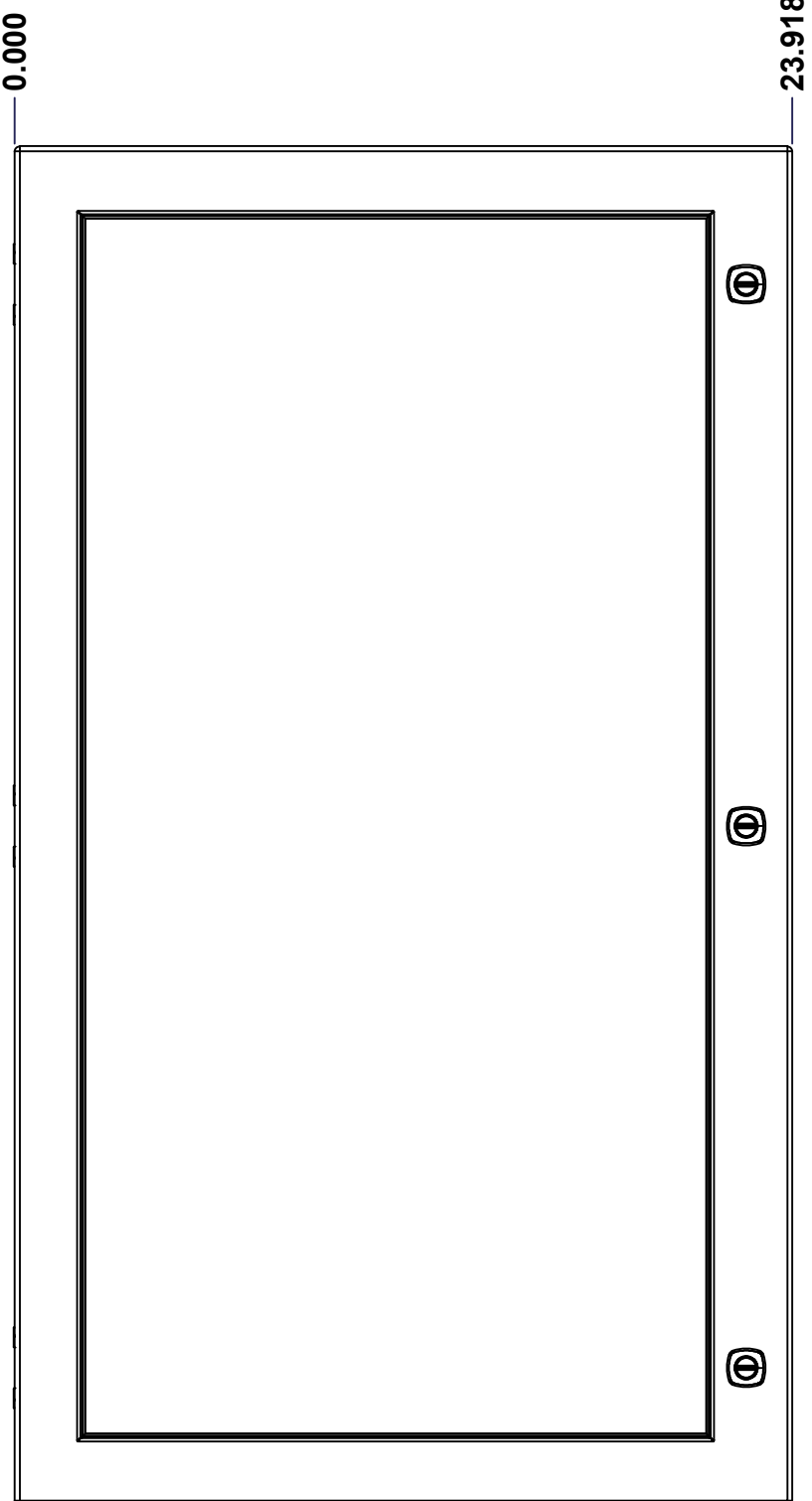

FRONT

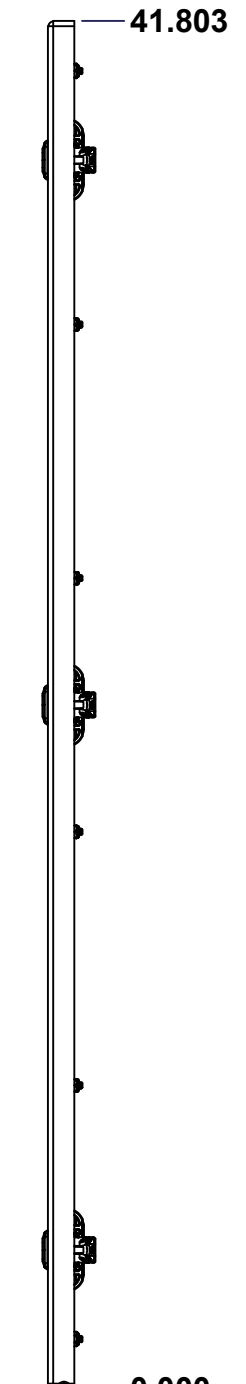

RIGHT

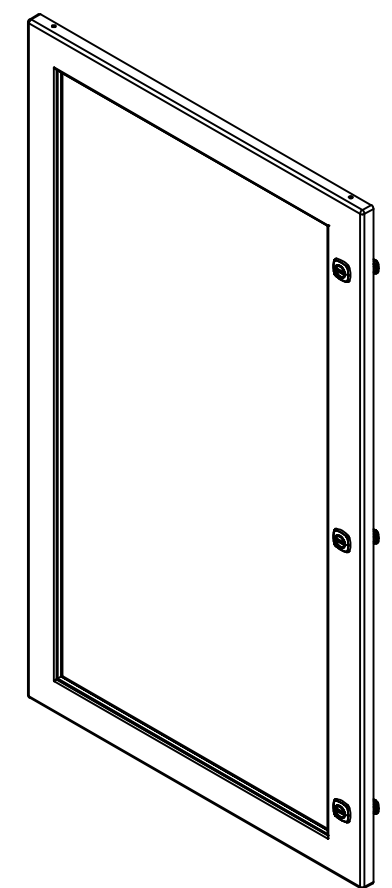

Isometric View

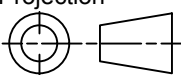

| No. | Revisions | Date | By/Par |
|-----|-----------|------|--------|
|     |           |      |        |
|     |           |      |        |
|     |           |      |        |
|     |           |      |        |

|  |   |   |
|--|---|---|
|  Tél: (450) 979-4373<br>Fax: (450) 979-4626<br><a href="http://www.exmweb.com">www.exmweb.com</a> |   | Flatness<br>Aplatissement<br>Max 3.0mm<br>Projection<br> |
| Customer<br>Client   | Date                                      |   |
| Drawn By<br>Dessiné Par  | BoxCad: BoxCad                            | Date 14-Mar-23  |
| Material<br>Matière  | 14 Ga Cold Rolled A1008 CS Type B (1.7mm) |   |
| Color<br>Couleur   | Asa-61 Grey                               | Finish<br>Fini Smooth   |
| Description<br>5412ESW 42" x 24" Cover   |   | Detail Rev.   |
| Part Number<br>Numéro Pièce  | Rev. 0                                    | 7<br>9  |

SEE BILL OF MATERIAL ON LAST PAGE

**5412ESW422412NOIPC**

This drawing is confidential and must not be reproduced or used without the consent of EXM

Ce dessin est confidentiel et ne doit pas être reproduit ou utilisé sans le consentement de EXM

| STANDARD FEATURES ARE NOT LISTED IN THIS HOLE TABLE |        |        |                         |
|---|--------|--------|-------------------------|
| HOLE TABLE - FRONT VIEW (CUSTOM FEATURE ONLY)       |        |        |                         |
| CUT-OUT   | XDIM   | YDIM   | DESCRIPTION             |
| 1   | 1.469  | 9.277  | STUD M6 x 18mm (Inside) |
| 2   | 21.968 | 9.277  | STUD M6 x 18mm (Inside) |
| 3   | 1.469  | 17.027 | STUD M6 x 18mm (Inside) |
| 4   | 21.968 | 17.027 | STUD M6 x 18mm (Inside) |
| 5   | 1.469  | 24.776 | STUD M6 x 18mm (Inside) |
| 6   | 21.968 | 24.776 | STUD M6 x 18mm (Inside) |
| 7   | 1.469  | 32.526 | STUD M6 x 18mm (Inside) |
| 8   | 21.968 | 32.526 | STUD M6 x 18mm (Inside) |
| 9   | 1.469  | 40.276 | STUD M6 x 18mm (Inside) |
| 10  | 1.469  | 1.527  | STUD M6 x 18mm (Inside) |
| 11  | 8.302  | 40.276 | STUD M6 x 18mm (Inside) |
| 12  | 8.302  | 1.527  | STUD M6 x 18mm (Inside) |
| 13  | 15.135 | 40.276 | STUD M6 x 18mm (Inside) |
| 14  | 15.135 | 1.527  | STUD M6 x 18mm (Inside) |
| 15  | 21.968 | 40.276 | STUD M6 x 18mm (Inside) |
| 16  | 21.968 | 1.527  | STUD M6 x 18mm (Inside) |
| -----   |        |        |                         |
| 17  | 22.494 | 37.553 | 880 SCQ4-SL             |
| 18  | 22.494 | 20.902 | 880 SCQ4-SL             |
| 19  | 22.494 | 4.250  | 880 SCQ4-SL             |

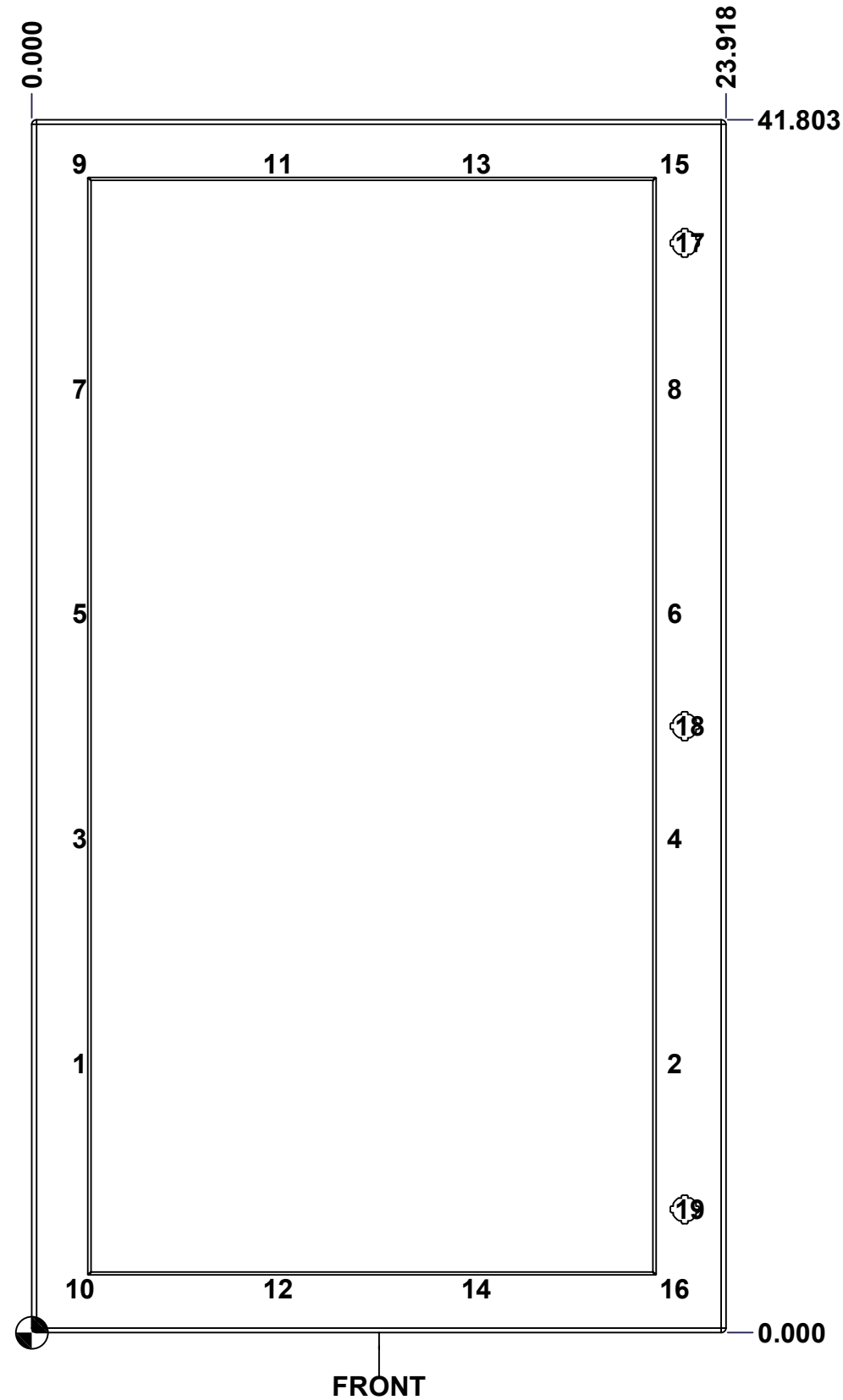

|  |                             |        |
|--|-----------------------------|--------|
|  | Description                 | Status |
|  | 5412ESW 42" x 24" Cover     | (NULL) |
|  | Part Number<br>Numéro Pièce | Rev.   |
|  | 5412ESW422412NOIPC          | 0      |
|  |                             | 8      |
|  |                             | 9      |



This drawing is confidential and must not be reproduced or used without the consent of EXM

Ce dessin est confidentiel et ne doit pas être reproduit ou utilisé sans le consentement de EXM

| No. | Revisions | Date | By/Par |
|-----|-----------|------|--------|
|     |           |      |        |
|     |           |      |        |
|     |           |      |        |
|     |           |      |        |
|     |           |      |        |

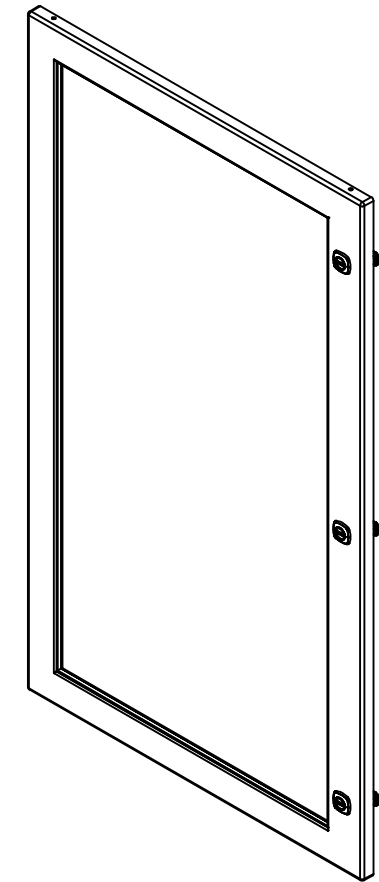

Isometric View

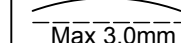
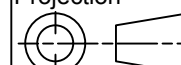

|            |                          |     |   |
|------------|--------------------------|-----|---|
| 1          | STK-P-02400S             | 0   | Powder Paint (Asa-61 Grey / Smooth)     |
| 12         | STK-Q-60701              | 2.1 | 880 WK - Lexan 1/4" Fixing Bracket      |
| 1          | STK-A-60703              | 0   | 5412 ESW Lexan Bracket Kit              |
| 16         | STK-Q-16052              | 0   | M6 x 23mm Stud (No Paint Cap Required)  |
| 1          | STK-G-02710              | 0   | 880 HWKG - Windows Kit Gasket           |
| 1          | 5412ESW422412NOIPLX<br>G | 0   | 5412ESW 42" x 24" Lexan Gasket Part     |
| 1          | 5412ESW422412NOIPLX      | 0   | 5412ESW 38.375" x 20.125" Lexan Part    |
| 1          | 5412ESW422412NOIPG       | 0   | 5412ESW 42" x 24" Cover Gasket Part     |
| 1          | 5412ESW422412NOIPC-P     | 0   | 5412ESW 42" x 24" Cover Part            |
| 3          | STK-K-09800              | 10  | 5412 ES Hinge with 2 Captive Hinge Pins |
| 3          | STK-K-12500              | 16  | 5412 ES 1/4 Turn Lock                   |
| Qty        | Part Name                | Rev | Description                             |
| Parts List |                          |     |   |

|  |   |   |
|--|---|---|
|  Tél: (450) 979-4373<br>Fax: (450) 979-4626<br><a href="http://www.exmweb.com">www.exmweb.com</a> |   | Flatness<br>Aplatissement<br> Max 3.0mm<br>Projection<br> |
| Customer<br>Client   | Date                                      | Date  |
| Drawn By<br>Dessiné Par  | BoxCad: BoxCad                            | Date 14-Mar-23  |
| Material<br>Matière  | 14 Ga Cold Rolled A1008 CS Type B (1.7mm) |   |
| Color<br>Couleur   | Asa-61 Grey                               | Finish<br>Fini<br>Smooth  |
| Description  | Detail Rev.                               |   |
| 5412ESW 42" x 24" Cover  |   |   |
| Part Number<br>Numéro Pièce  | Rev.                                      | 9   |
| <b>5412ESW422412NOIPC</b>  | <b>0</b>                                  | <b>9</b>  |