

This drawing is confidential and must not be reproduced or used without the consent of EXM

Ce dessin est confidentiel et ne doit pas être reproduit ou utilisé sans le consentement de EXM

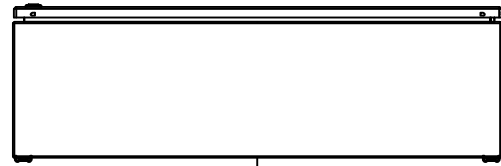

TOP

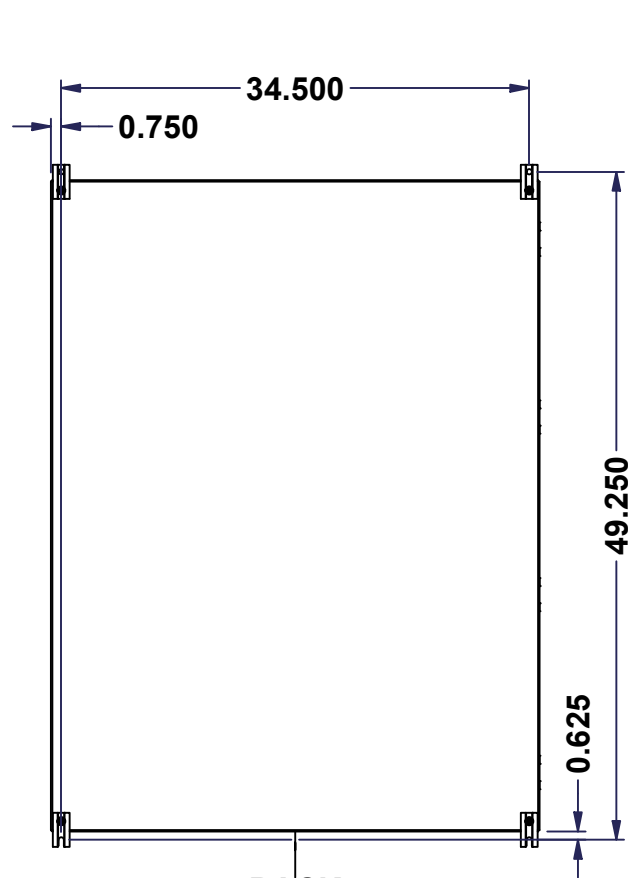

BACK

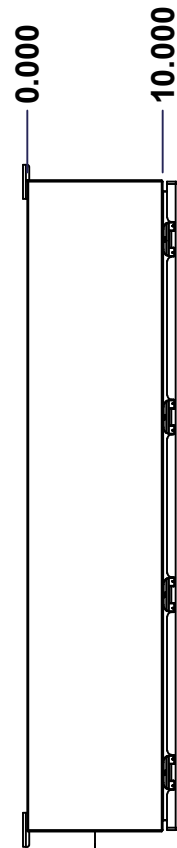

LEFT

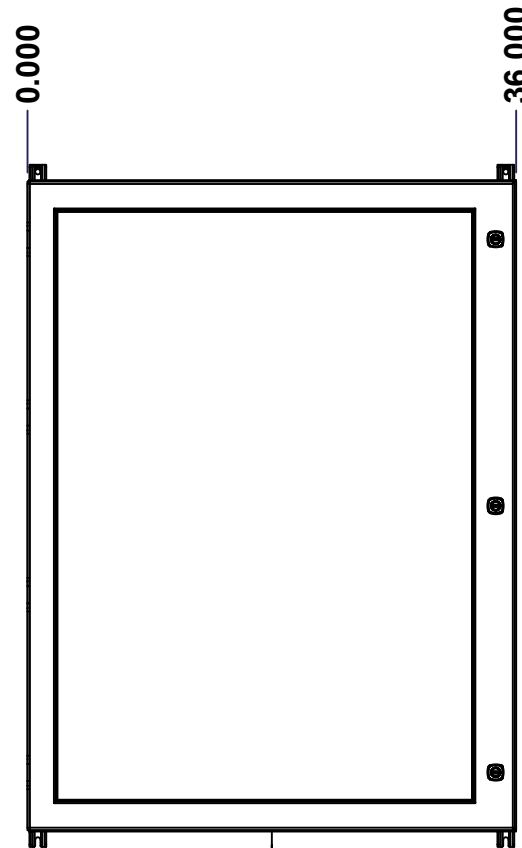

FRONT

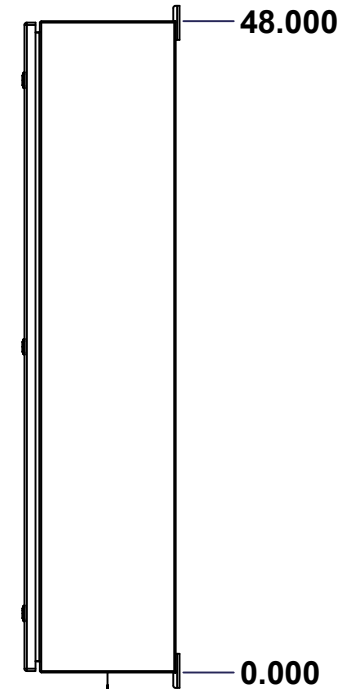

RIGHT

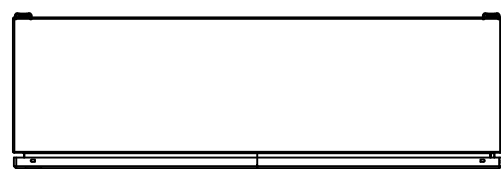

BOTTOM

No.	Revisions	Date	By/Par

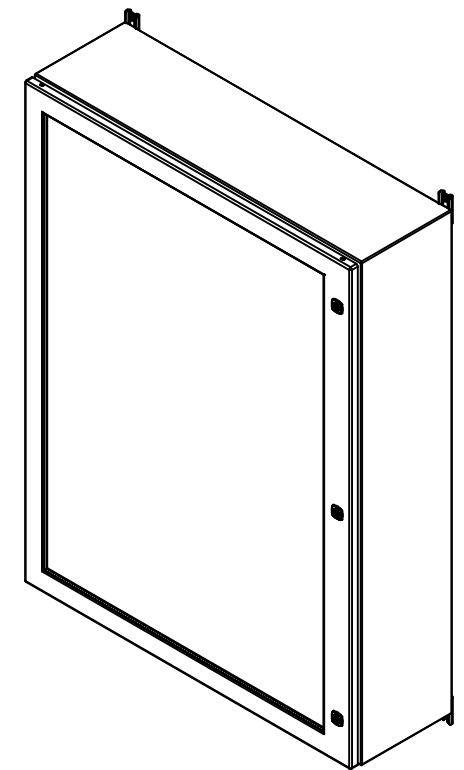

Isometric View



Tél: (450) 979-4373
 Fax: (450) 979-4626
www.exmweb.com

Flatness
Aplatissement

Max 3.0mm

Projection

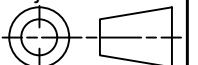

Customer Client	Date
Drawn By / Dessiné Par: BoxCad: BoxCad	Date: 16-Mar-23
Material / Matière: 14 Ga Cold Rolled A1008 CS Type B (1.7mm)	
Color / Couleur: Asa-61 Grey	Finish / Fini: Smooth
Description: 5412ESW 48" x 36" x 10" Assembly	Detail Rev.
Part Number / Numéro Pièce: 5412ESW483610TH	Rev. 1

SEE BILL OF MATERIAL ON LAST PAGE

This drawing is confidential and must not be reproduced or used without the consent of EXM

Ce dessin est confidentiel et ne doit pas être reproduit ou utilisé sans le consentement de EXM

NOTE	
ITEM	DESCRIPTION
1	NEMA 4/12 Enclosure
2	C/W Standard ground studs on box and cover
3	W/O Standard door stiffener
4	C/W Standard inner panel (Included)
5	C/W Standard inner panel mounting studs
6	C/W 885 ESMF3_OPEN Sold separately (Installed)
7	C/W 885 ESMF3_CLOSE Sold separately (Installed)
8	C/W R5 Insulation (Installed by EXM)

No.	Revisions	Date	By/Par

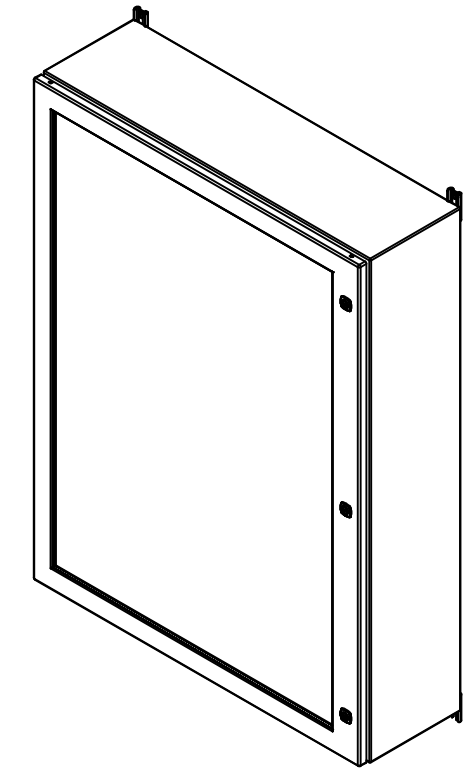

Isometric View

 Tél: (450) 979-4373
 Fax: (450) 979-4626
www.exmweb.com

Flatness
 Aplatissement

 Max 3.0mm
 Projection

Customer Client	Date
Drawn By Dessiné Par BoxCad: BoxCad	Date 16-Mar-23
Material Matière 14 Ga Cold Rolled A1008 CS Type B (1.7mm)	

Color Couleur Asa-61 Grey	Finish Fini Smooth
Description 5412ESW 48" x 36" x 10" Assembly	Detail Rev.
Part Number Numéro Pièce 5412ESW483610TH	Rev. 0

PACKING		
ITEM	QTY	DESCRIPTION
Cardboard sleeve	2	Top and Bottom
Cardboard strip	2	Between back of enclosure and inner panel
Plastic bag	1	To protect cover surface and inside gasket
Cardboard corner	4	To reinforced for the plastic strap tightening
Plastic strap - Black	2	To Squeeze the 2 cardboard sleeve together
Packaging label	3	White label with PN
Plastic strap- Green	2	To secure the enclosure to the wood pallet
Wood Pallet	1	2" deeper and 3" larger than enclosure size

Qty	Part Number	Rev	Description
8	STK-Q-00600	2	M12 to M8 Adaptor
1	881 SP4836G	0	881 SP - Inner Panel
1	STK-K-01800	5	5412 ES Accessory Kit
1	5412ESW483610THC	0	5412ESW 48" x 36" Cover
1	5412ESW483610THB	0	5412ESW 48" x 36" x 10" Body
4	STK-Q-04050-08	0	M6 x 8mm Hexagon Socket Head Machine Screw
Parts List			

This drawing is confidential and must not be reproduced or used without the consent of EXM

Ce dessin est confidentiel et ne doit pas être reproduit ou utilisé sans le consentement de EXM

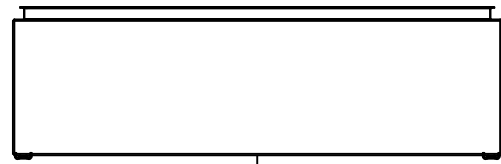

TOP

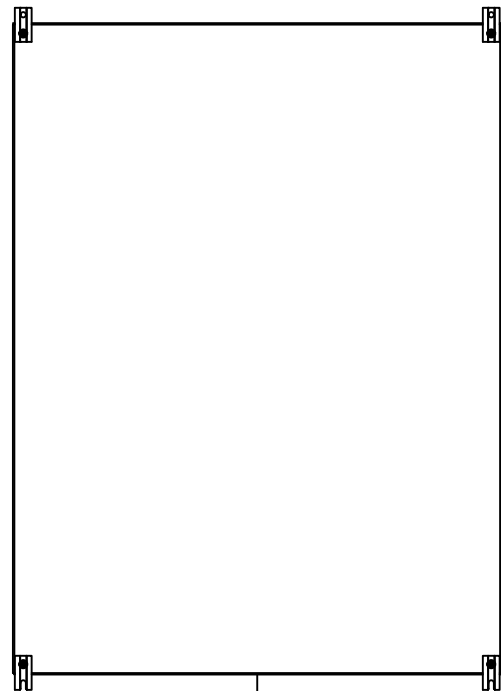

BACK

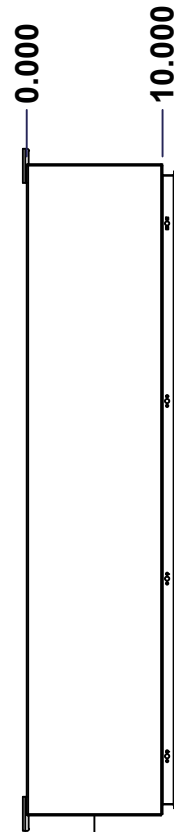

LEFT

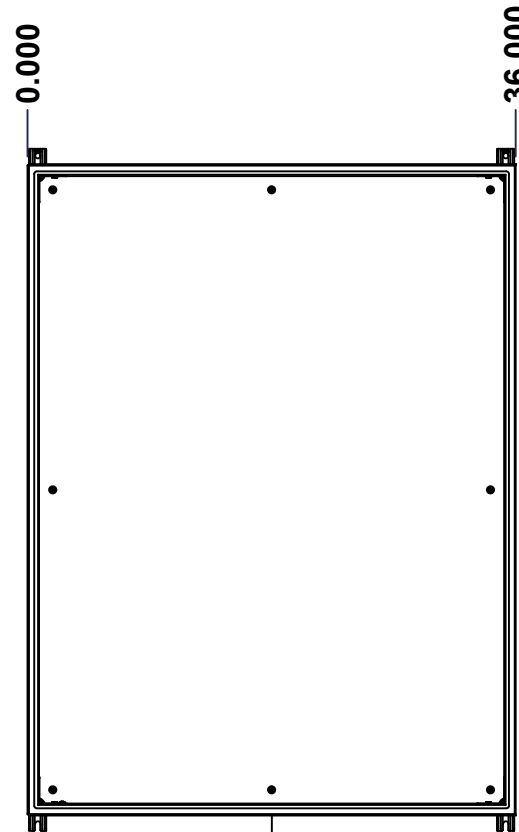

FRONT

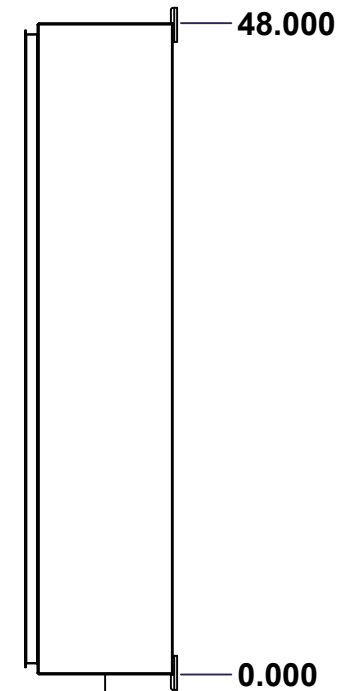

RIGHT

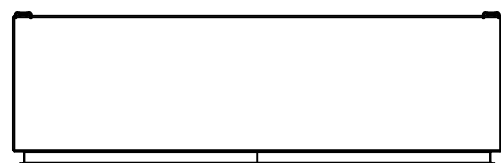

BOTTOM

No.	Revisions	Date	By/Par

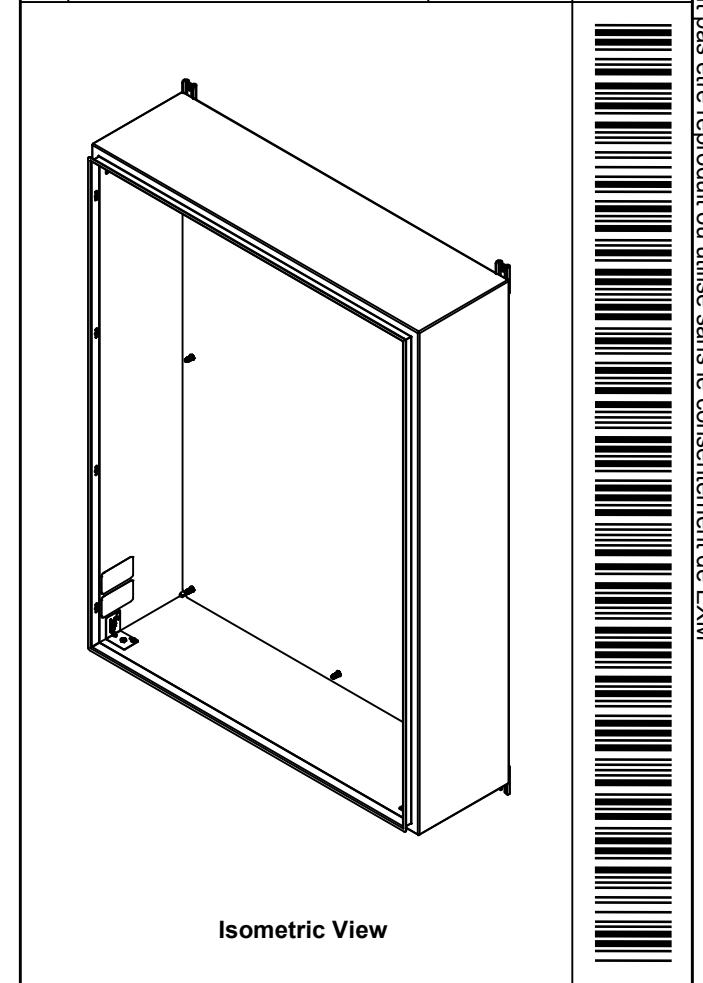

Isometric View

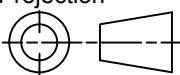

 Tél: (450) 979-4373 Fax: (450) 979-4626 www.exmweb.com		Flatness Aplatissement Max 3.0mm Projection 
Customer Client	Date	
Drawn By Dessiné Par	BoxCad: BoxCad	Date 16-Mar-23
Material Matière	14 Ga Cold Rolled A1008 CS Type B (1.7mm)	
Color Couleur	Asa-61 Grey	Finish Fini Smooth
Description	Detail Rev.	
5412ESW 48" x 36" x 10" Body		
Part Number Numéro Pièce	Rev. 0	3 / 15

SEE BILL OF MATERIAL ON LAST PAGE

5412ESW483610THB

This drawing is confidential and must not be reproduced or used without the consent of EXM

Ce dessin est confidentiel et ne doit pas être reproduit ou utilisé sans le consentement de EXM

STANDARD FEATURES ARE NOT LISTED IN THIS HOLE TABLE			
HOLE TABLE - TOP VIEW (CUSTOM FEATURE ONLY)			
CUT-OUT	XDIM	YDIM	DESCRIPTION
1	2.000	8.500	INSUL. STUD M6 x 18mm (Inside)
2	34.000	8.500	INSUL. STUD M6 x 18mm (Inside)

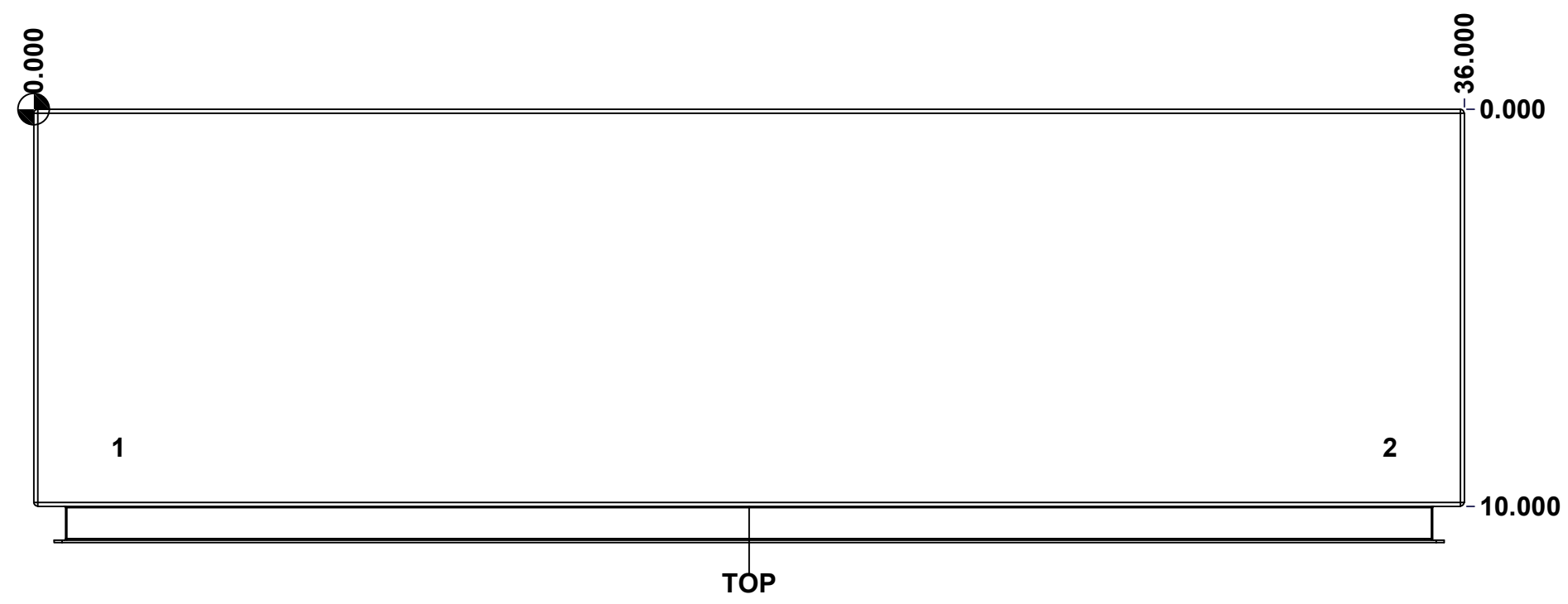

	Description	Status	
	5412ESW 48" x 36" x 10" Body	(NULL)	
	Part Number Numéro Pièce	Rev.	4
	5412ESW483610THB	0	15

This drawing is confidential and must not be reproduced or used without the consent of EXM

Ce dessin est confidentiel et ne doit pas être reproduit ou utilisé sans le consentement de EXM

STANDARD FEATURES ARE NOT LISTED IN THIS HOLE TABLE			
HOLE TABLE - BOTTOM VIEW (CUSTOM FEATURE ONLY)			
CUT-OUT	XDIM	YDIM	DESCRIPTION
1	2.000	8.500	INSUL. STUD M6 x 18mm (Inside)
2	34.000	8.500	INSUL. STUD M6 x 18mm (Inside)

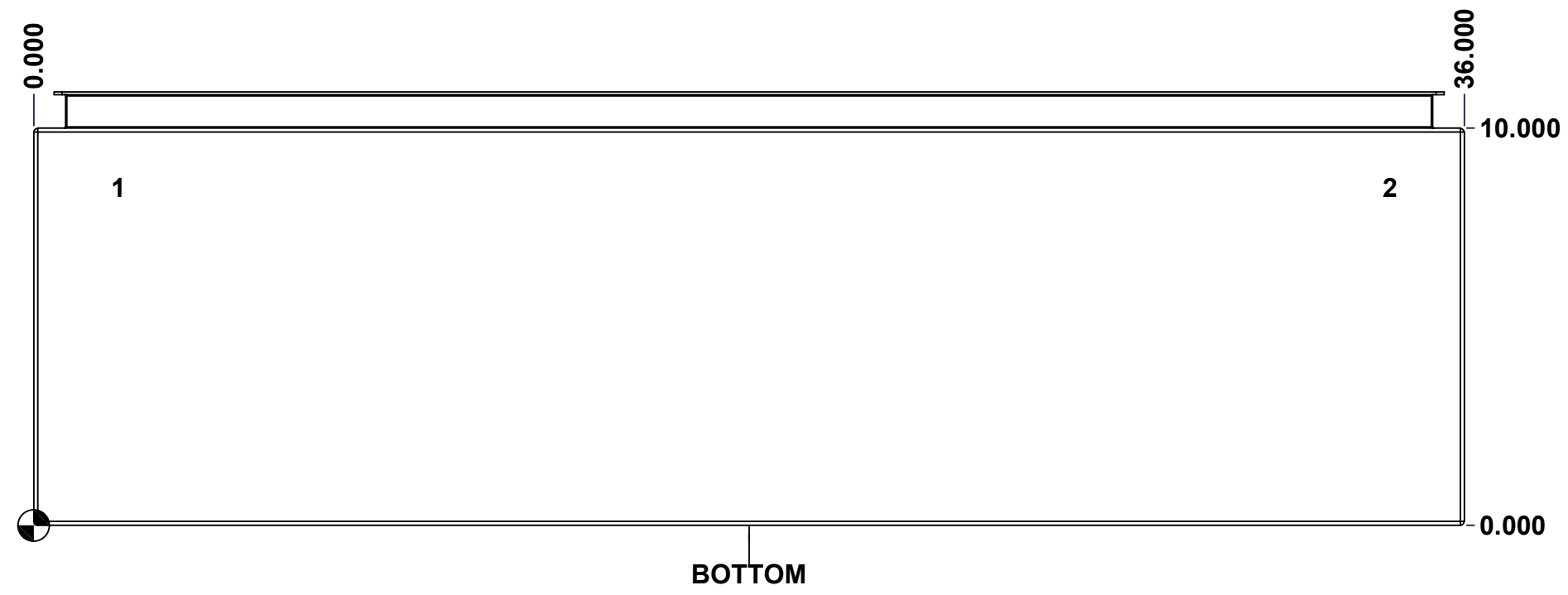

	Description	Status	
	5412ESW 48" x 36" x 10" Body	(NULL)	
	Part Number Numéro Pièce	Rev.	5
	5412ESW483610THB	0	15

This drawing is confidential and must not be reproduced or used without the consent of EXM

Ce dessin est confidentiel et ne doit pas être reproduit ou utilisé sans le consentement de EXM

STANDARD FEATURES ARE NOT LISTED IN THIS HOLE TABLE

HOLE TABLE - BACK VIEW (CUSTOM FEATURE ONLY)

CUT-OUT	XDIM	YDIM	DESCRIPTION
1	1.875	1.875	IP STUD M8 x 35mm (Inside)
2	1.875	46.125	IP STUD M8 x 35mm (Inside)
3	34.125	46.125	IP STUD M8 x 35mm (Inside)
4	34.125	1.875	IP STUD M8 x 35mm (Inside)
5	1.875	24.000	IP STUD M8 x 35mm (Inside)
6	34.125	24.000	IP STUD M8 x 35mm (Inside)
7	18.000	1.875	IP STUD M8 x 35mm (Inside)
8	18.000	46.125	IP STUD M8 x 35mm (Inside)

9	35.250	0.000	FOOT 885 ESMF3_OPEN
10	0.750	48.000	FOOT 885 ESMF3_CLOSE
11	0.750	0.000	FOOT 885 ESMF3_OPEN
12	35.250	48.000	FOOT 885 ESMF3_CLOSE

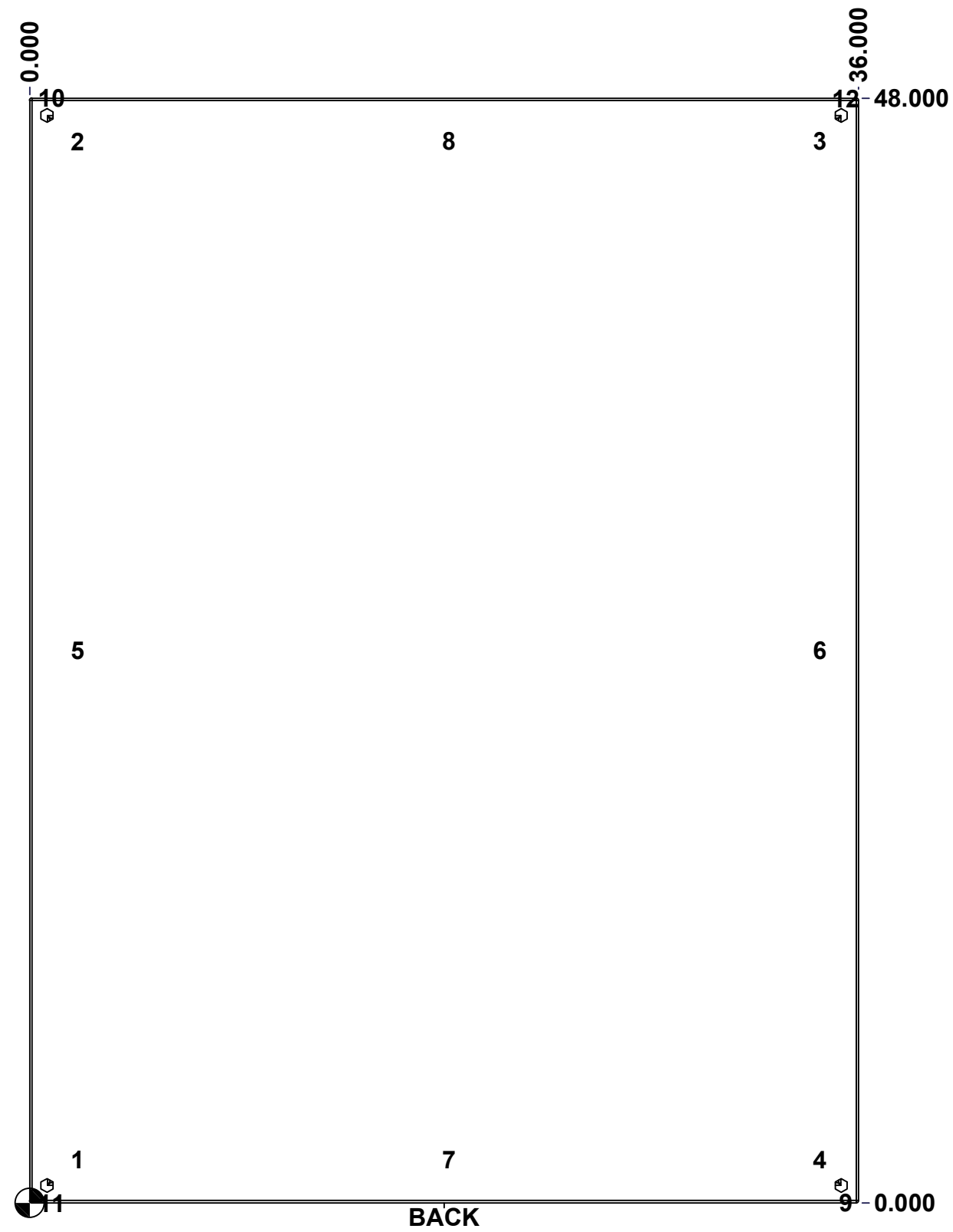

	Description	Status
	5412ESW 48" x 36" x 10" Body	(NULL)
Part Number Numéro Pièce	5412ESW483610THB	Rev. 6
		0

This drawing is confidential and must not be reproduced or used without the consent of EXM

Ce dessin est confidentiel et ne doit pas être reproduit ou utilisé sans le consentement de EXM

No.	Revisions	Date	By/Par

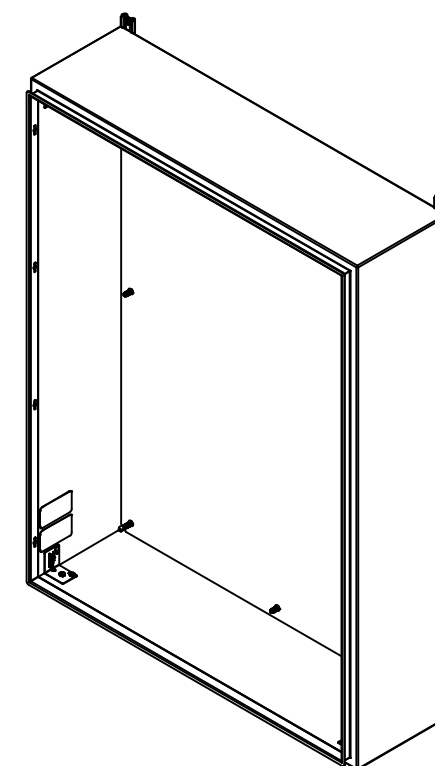

Isometric View



2	885ESMF3-FEET	0	885 ESMF3 Mounting Foot
4	RIVET_NUT_M10_FH_CE	0	Rivet Nut M10 (Low Profile Close End)
4	STK-Q-06660	2	M10 x 16mm Machine Screw
2	885ESMF3-FEET-A	0	885 ESMF3 Mounting Foot (Opened Slot)
2	STK-S-00100	0	3.5" x 2" Silver Milar Flexcon Sticker
1	STK-K-70554	3	5412 ESTH Accessory Kit
1	5412ESW483610THI-RS	0	5412ESW 48" x 36" Right Insulation
1	5412ESW483610THI-LS	0	5412ESW 48" x 36" Left Insulation
1	5412ESW483610THI-BT	0	5412ESW 48" x 36" Top and Bottom Insulation
1	5412ESW483610THI-TP	0	5412ESW 48" x 36" Top and Bottom Insulation
1	5412ESW483610THI-B	0	5412ESW 48" x 36" Back Insulation
4	STK-Q-16055	1	M6 x 18mm Stud (No Paint Cap Required)
1	STK-P-02400S	0	Powder Paint (Asa-61 Grey / Smooth)
8	STK-Q-16005	1	Stud M8 x 35 (No Paint Cap Required)
1	5412ESW483610THB-P	0	5412ESW 48" x 36" x 10" Body Part

Qty	Part Number	Rev	Description
Parts List			

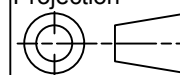
 Tél: (450) 979-4373 Fax: (450) 979-4626 www.exmweb.com	Flatness Aplatissement	Max 3.0mm
	Projection	
Customer Client	Date	
Drawn By Dessiné Par	BoxCad: BoxCad	Date 16-Mar-23
Material Matière	14 Ga Cold Rolled A1008 CS Type B (1.7mm)	
Color Couleur	Asa-61 Grey	Finish Fini Smooth
Description	5412ESW 48" x 36" x 10" Body	
Part Number Numéro Pièce	Rev. 0	7 / 15
5412ESW483610THB		

This drawing is confidential and must not be reproduced or used without the consent of EXM

Ce dessin est confidentiel et ne doit pas être reproduit ou utilisé sans le consentement de EXM

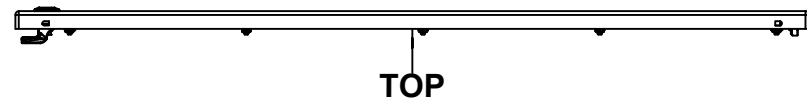

TOP

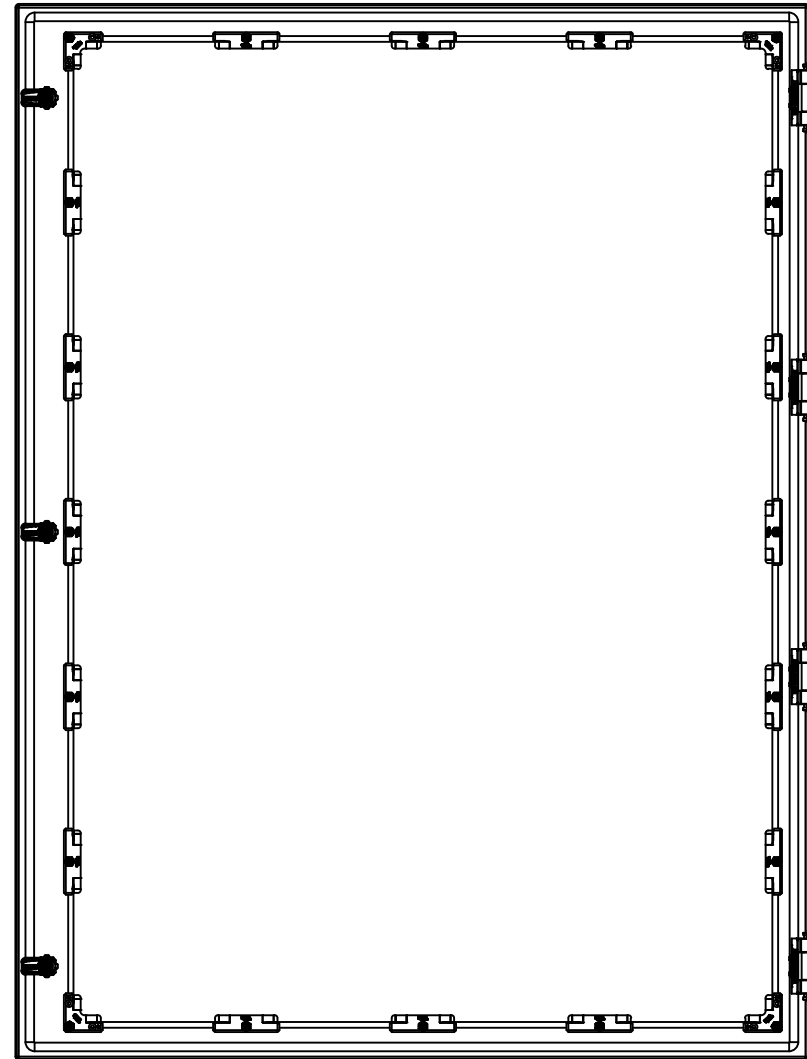

BACK

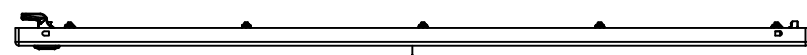

BOTTOM

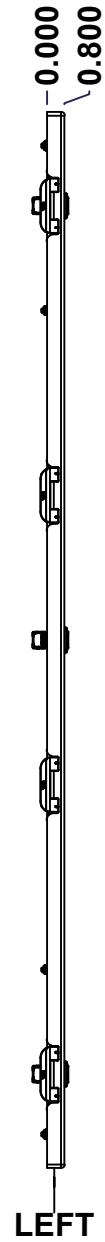

LEFT

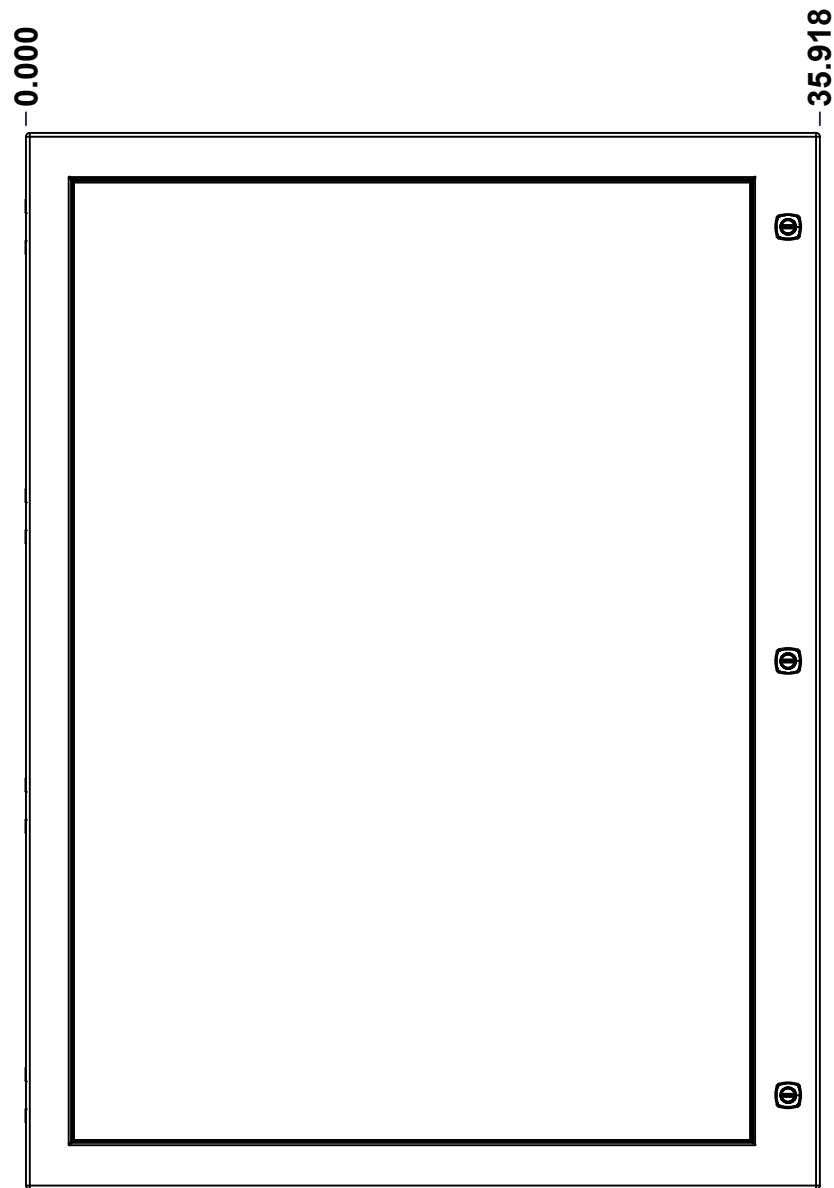

FRONT

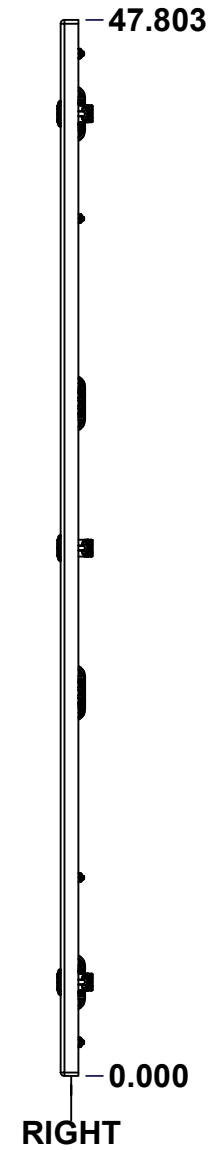

RIGHT

No.	Revisions	Date	By/Par

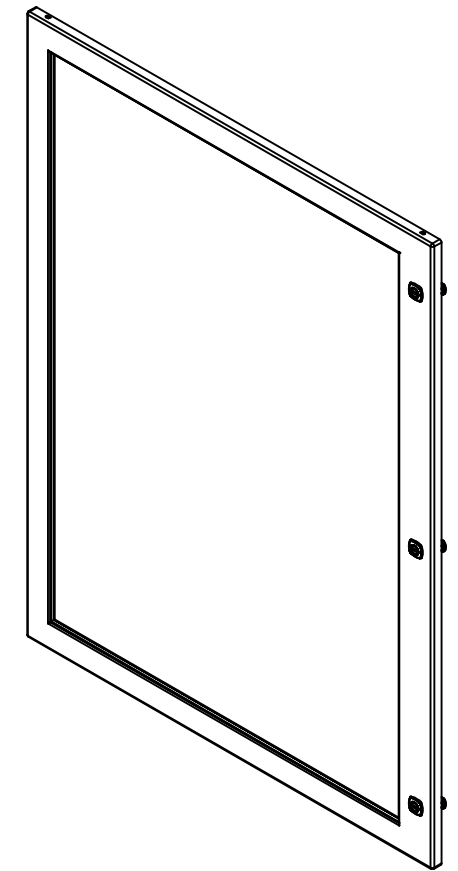

Isometric View

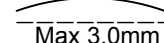
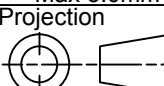

 Tél: (450) 979-4373 Fax: (450) 979-4626 www.exmweb.com		Flatness Aplatissement  Max 3.0mm	
		Projection 	
Customer Client		Date	
Drawn By Dessiné Par BoxCad: BoxCad		Date 16-Mar-23	
Material Matière 14 Ga Cold Rolled A1008 CS Type B (1.7mm)			
Color Couleur Asa-61 Grey		Finish Fini Smooth	
Description 5412ESW 48" x 36" Cover			Detail Rev.
Part Number Numéro Pièce 5412ESW483610THC		Rev. 0	8 / 15

SEE BILL OF MATERIAL ON LAST PAGE

This drawing is confidential and must not be reproduced or used without the consent of EXM

Ce dessin est confidentiel et ne doit pas être reproduit ou utilisé sans le consentement de EXM

STANDARD FEATURES ARE NOT LISTED IN THIS HOLE TABLE

HOLE TABLE - FRONT VIEW (CUSTOM FEATURE ONLY)

CUT-OUT	XDIM	YDIM	DESCRIPTION
1	1.469	8.985	STUD M6 x 18mm (Inside)
2	33.468	8.985	STUD M6 x 18mm (Inside)
3	1.469	16.443	STUD M6 x 18mm (Inside)
4	33.468	16.443	STUD M6 x 18mm (Inside)
5	1.469	23.902	STUD M6 x 18mm (Inside)
6	33.468	23.902	STUD M6 x 18mm (Inside)
7	1.469	31.360	STUD M6 x 18mm (Inside)
8	33.468	31.360	STUD M6 x 18mm (Inside)
9	1.469	38.818	STUD M6 x 18mm (Inside)
10	33.468	38.818	STUD M6 x 18mm (Inside)
11	1.469	46.276	STUD M6 x 18mm (Inside)
12	1.469	1.527	STUD M6 x 18mm (Inside)
13	9.469	46.276	STUD M6 x 18mm (Inside)
14	9.469	1.527	STUD M6 x 18mm (Inside)
15	17.469	46.276	STUD M6 x 18mm (Inside)
16	17.469	1.527	STUD M6 x 18mm (Inside)
17	25.468	46.276	STUD M6 x 18mm (Inside)
18	25.468	1.527	STUD M6 x 18mm (Inside)
19	33.468	46.276	STUD M6 x 18mm (Inside)
20	33.468	1.527	STUD M6 x 18mm (Inside)

21	34.494	43.553	880 SCQ4-SL
22	34.494	23.902	880 SCQ4-SL
23	34.494	4.250	880 SCQ4-SL

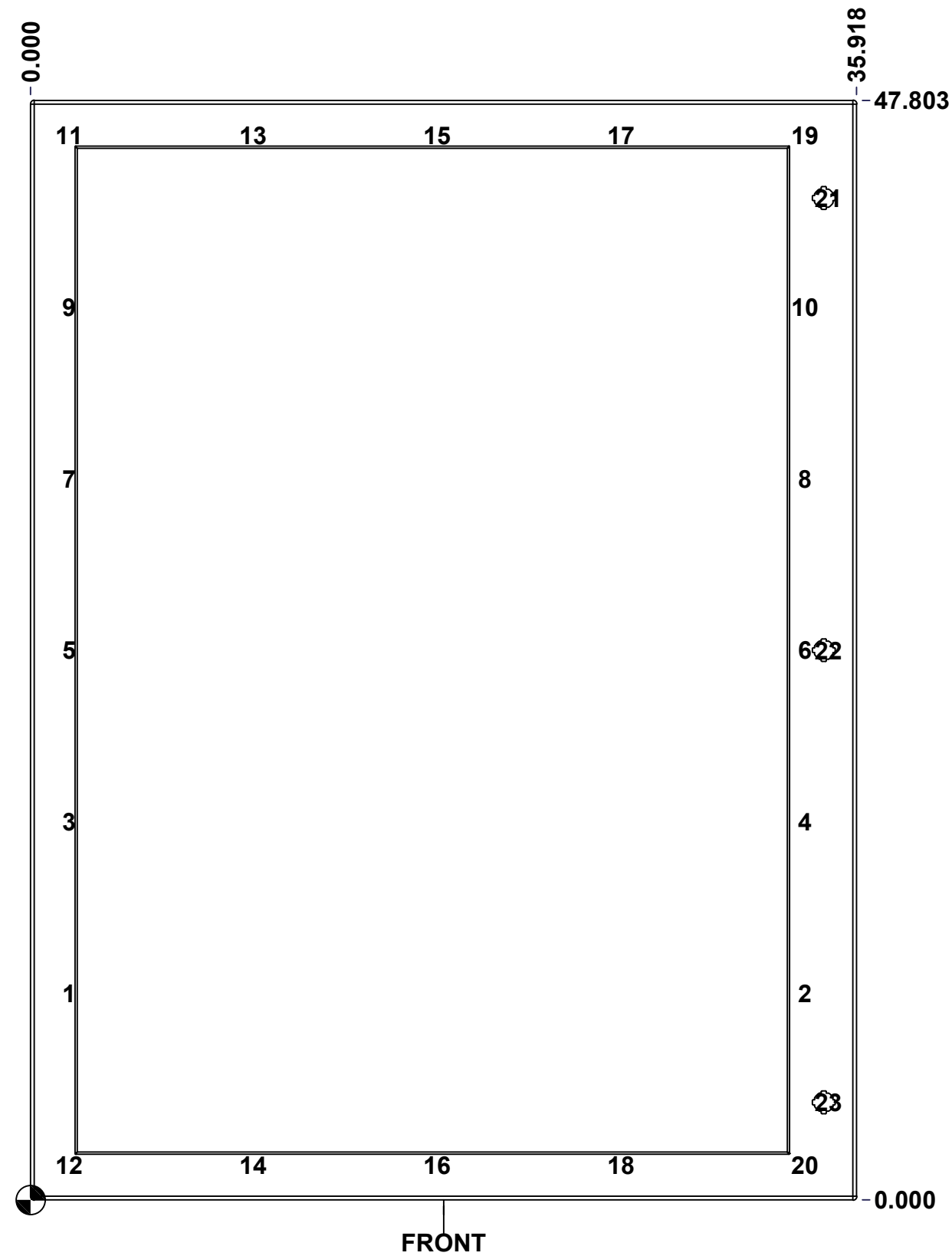

FRONT

	Description	Status
	5412ESW 48" x 36" Cover	(NULL)
	Part Number	Rev.
	Numéro Pièce	9
	5412ESW483610THC	0
		15

This drawing is confidential and must not be reproduced or used without the consent of EXM

Ce dessin est confidentiel et ne doit pas être reproduit ou utilisé sans le consentement de EXM

No.	Revisions	Date	By/Par

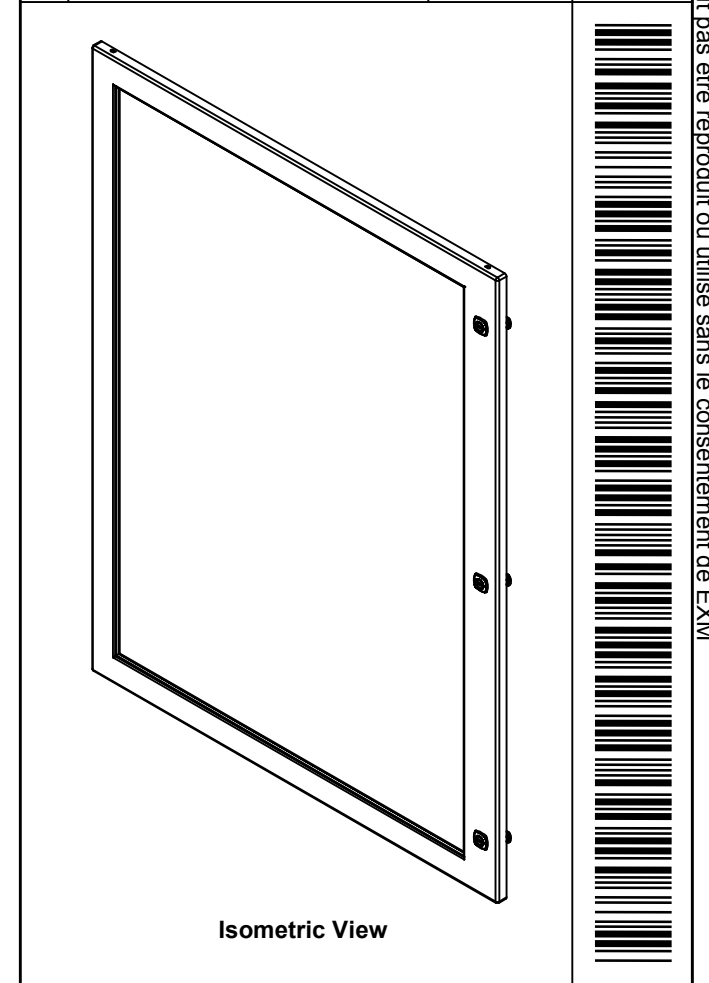

EXM
www.exmweb.com

Tél: (450) 979-4373
Fax: (450) 979-4626

Flatness
Aplatissement
Max 3.0mm

Projection

1	STK-P-02400S	0	Powder Paint (Asa-61 Grey / Smooth)
16	STK-Q-60701	2.1	880 WK - Lexan 1/4" Fixing Bracket
1	STK-A-60703	0	5412 ESW Lexan Bracket Kit
20	STK-Q-16052	0	M6 x 23mm Stud (No Paint Cap Required)
1	STK-G-02710	0	880 HWKG - Windows Kit Gasket
1	5412ESW483610THLXG	0	5412ESW 48" x 36" Lexan Gasket Part
1	5412ESW483610THLX	0	5412ESW 44.375" x 32.125" Lexan Part
1	5412ESW483610THG	0	5412ESW 48" x 36" Cover Gasket Part
1	5412ESW483610THC-P	0	5412ESW 48" x 36" Cover Part
4	STK-K-09800	10	5412 ES Hinge with 2 Captive Hinge Pins
3	STK-K-12500	16	5412 ES 1/4 Turn Lock
QTY	Part Number	Rev	Description
Parts List			

Customer Client	Date
Drawn By / Dessiné Par: BoxCad: BoxCad	Date: 16-Mar-23
Material / Matière: 14 Ga Cold Rolled A1008 CS Type B (1.7mm)	
Color / Couleur: Asa-61 Grey	Finish / Fini: Smooth
Description: 5412ESW 48" x 36" Cover	Detail Rev.:
Part Number / Numéro Pièce: 5412ESW483610THC	Rev. 0
	10
	15

This drawing is confidential and must not be reproduced or used without the consent of EXM

Ce dessin est confidentiel et ne doit pas être reproduit ou utilisé sans le consentement de EXM

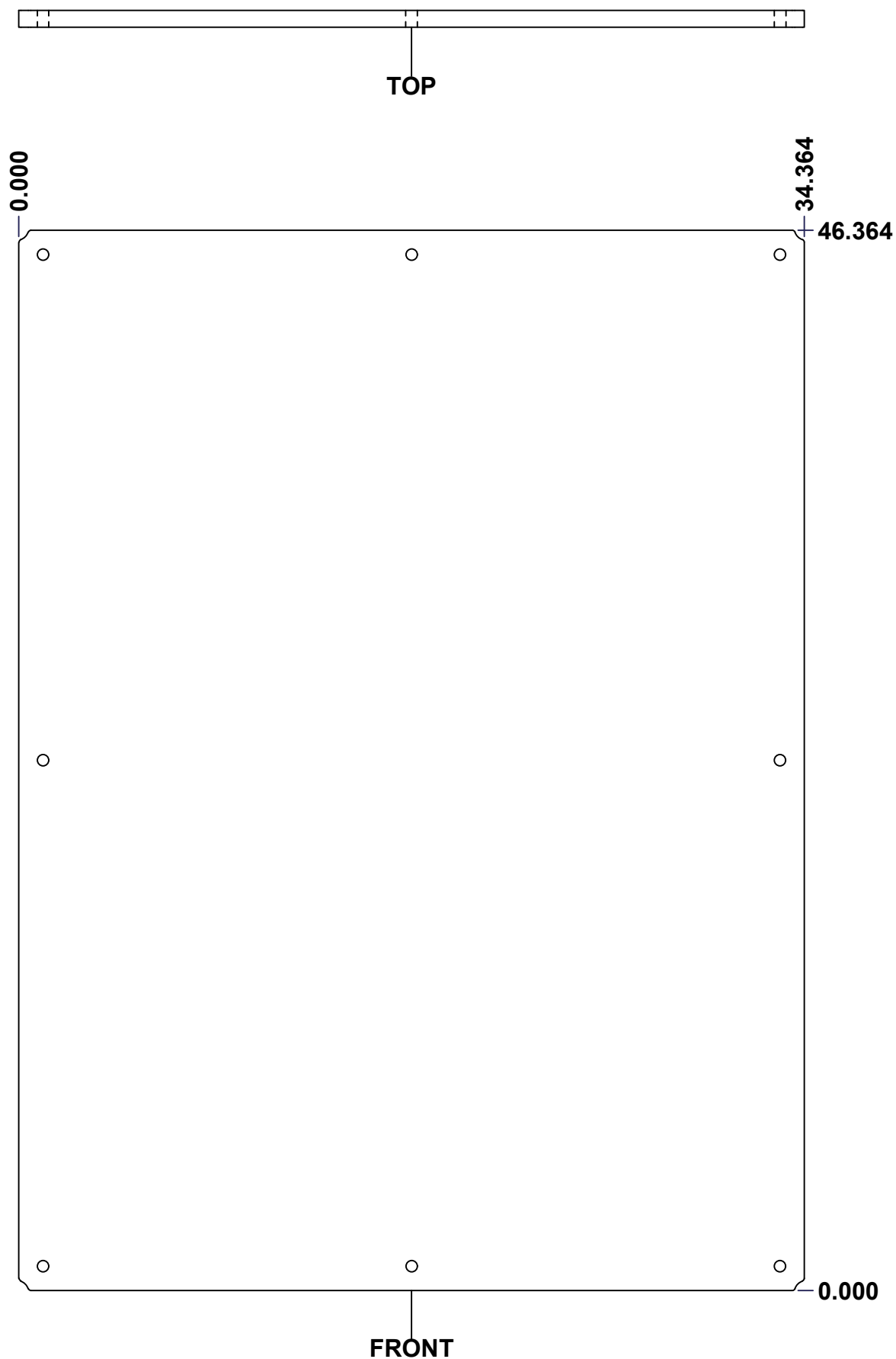

No.	Revisions	Date	By/Par

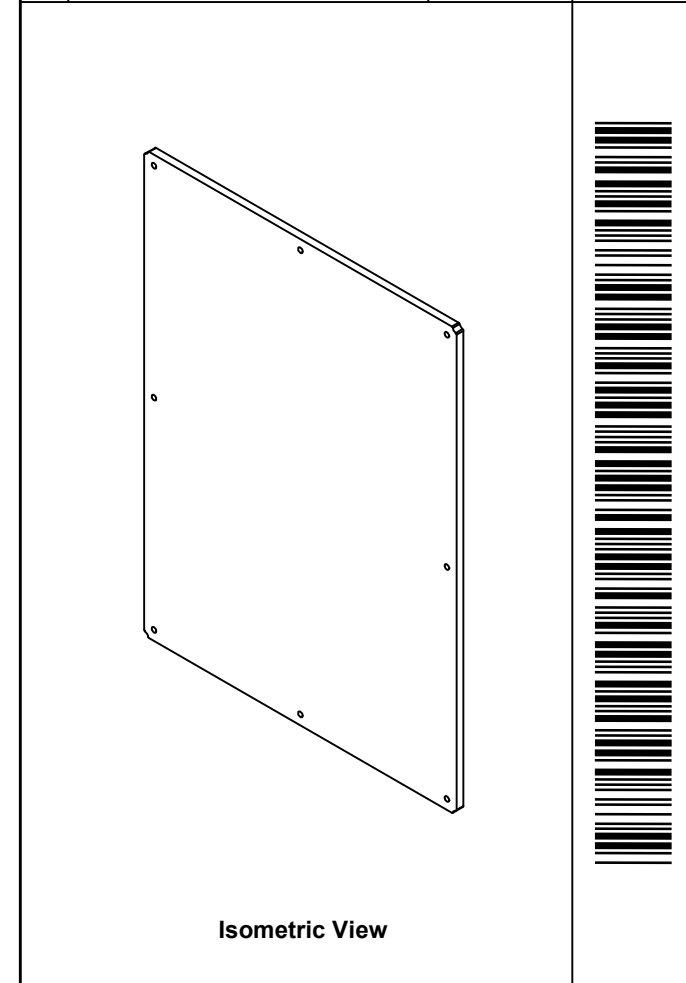

Isometric View

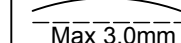
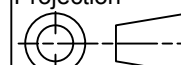
 Tél: (450) 979-4373 Fax: (450) 979-4626 www.exmweb.com		Flatness Aplatissement  Max 3.0mm
Projection 		Date 23-Jan-07
Customer Client	Date	
Drawn By Dessiné Par	BoxCad: Patrick Deschenes	Date 23-Jan-07
Material Matière	Polyisocyanurate	
Color Couleur	Aluminum	Finish Fini N/A
Description 5412ESW 48" x 36" Back Insulation		Detail Rev.
Part Number Numéro Pièce	Rev. 0	11 / 15

SEE BILL OF MATERIAL ON LAST PAGE

5412ESW483610THI-B

This drawing is confidential and must not be reproduced or used without the consent of EXM

Ce dessin est confidentiel et ne doit pas être reproduit ou utilisé sans le consentement de EXM

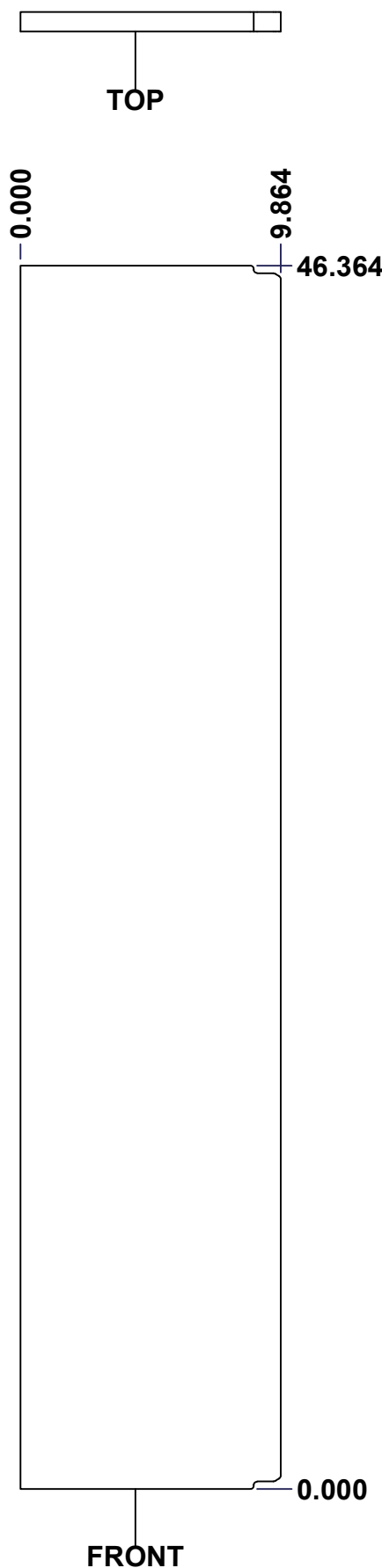

No.	Revisions	Date	By/Par

Isometric View

Tél: (450) 979-4373 Fax: (450) 979-4626 www.exmweb.com		Flatness Aplatissement Max 3.0mm
Projection 		Date 23-Jan-07
Customer Client	Date	
Drawn By Dessiné Par	BoxCad: Patrick Deschenes	Date 23-Jan-07
Material Matière	Polyisocyanurate	
Color Couleur	Aluminum	Finish Fini N/A
Description 5412ESW 48" x 36" Left Insulation		Detail Rev.
Part Number Numéro Pièce	Rev. 0	12 15

SEE BILL OF MATERIAL ON LAST PAGE

5412ESW483610THI-LS

This drawing is confidential and must not be reproduced or used without the consent of EXM

Ce dessin est confidentiel et ne doit pas être reproduit ou utilisé sans le consentement de EXM

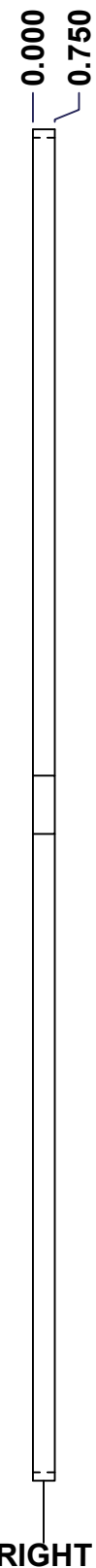
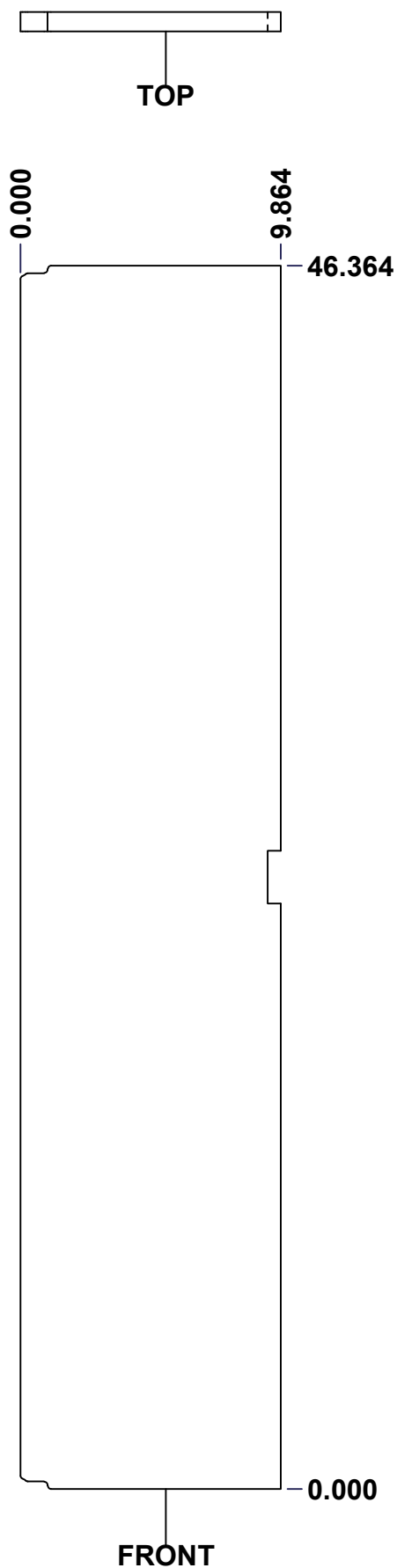

Isometric View

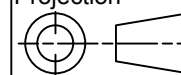

No.	Revisions	Date	By/Par

 Tél: (450) 979-4373 Fax: (450) 979-4626 www.exmweb.com		Flatness Aplatissement Max 3.0mm
Projection 		Customer Client Date
Drawn By Dessiné Par BoxCad: Patrick Deschenes		Date 23-Jan-07
Material Matière Polyisocyanurate		
Color Couleur Aluminum	Finish Fini N/A	
Description 5412ESW 48" x 36" Right Insulation		Detail Rev.
Part Number Numéro Pièce 5412ESW483610THI-RS		Rev. 13 0

SEE BILL OF MATERIAL ON LAST PAGE

This drawing is confidential and must not be reproduced or used without the consent of EXM

Ce dessin est confidentiel et ne doit pas être reproduit ou utilisé sans le consentement de EXM



TOP

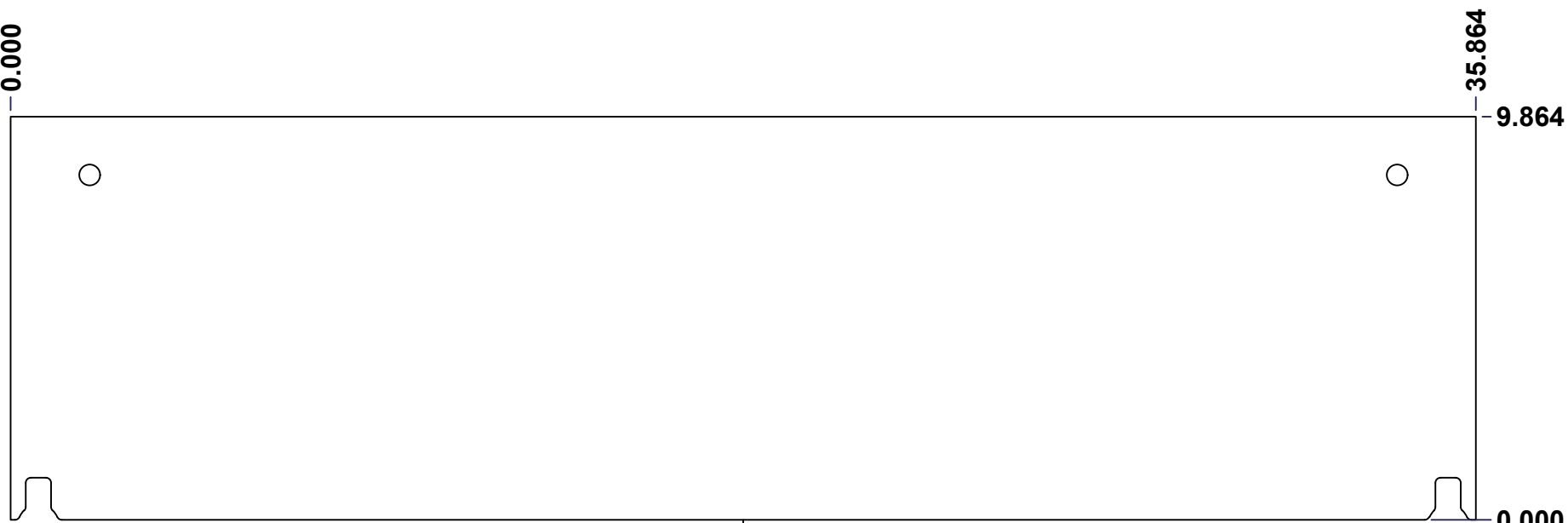

FRONT

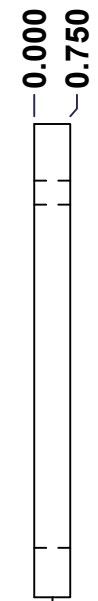

RIGHT

No.	Revisions	Date	By/Par

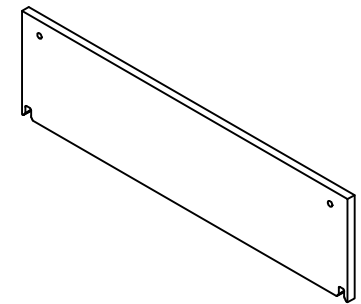

Isometric View



Tél: (450) 979-4373
 Fax: (450) 979-4626
www.exmweb.com

Flatness
Aplatissement
Max 3.0mm
Projection

Customer Client	Date
Drawn By / Dessiné Par: BoxCad: Patrick Deschenes	Date: 23-Jan-07
Material / Matière: Polyisocyanurate	
Color / Couleur: Aluminum	Finish / Fini: N/A
Description: 5412ESW 48" x 36" Top and Bottom Insulation	Detail Rev.
Part Number / Numéro Pièce: 5412ESW483610THI-TP	Rev. 0

SEE BILL OF MATERIAL ON LAST PAGE

This drawing is confidential and must not be reproduced or used without the consent of EXM

Ce dessin est confidentiel et ne doit pas être reproduit ou utilisé sans le consentement de EXM



TOP

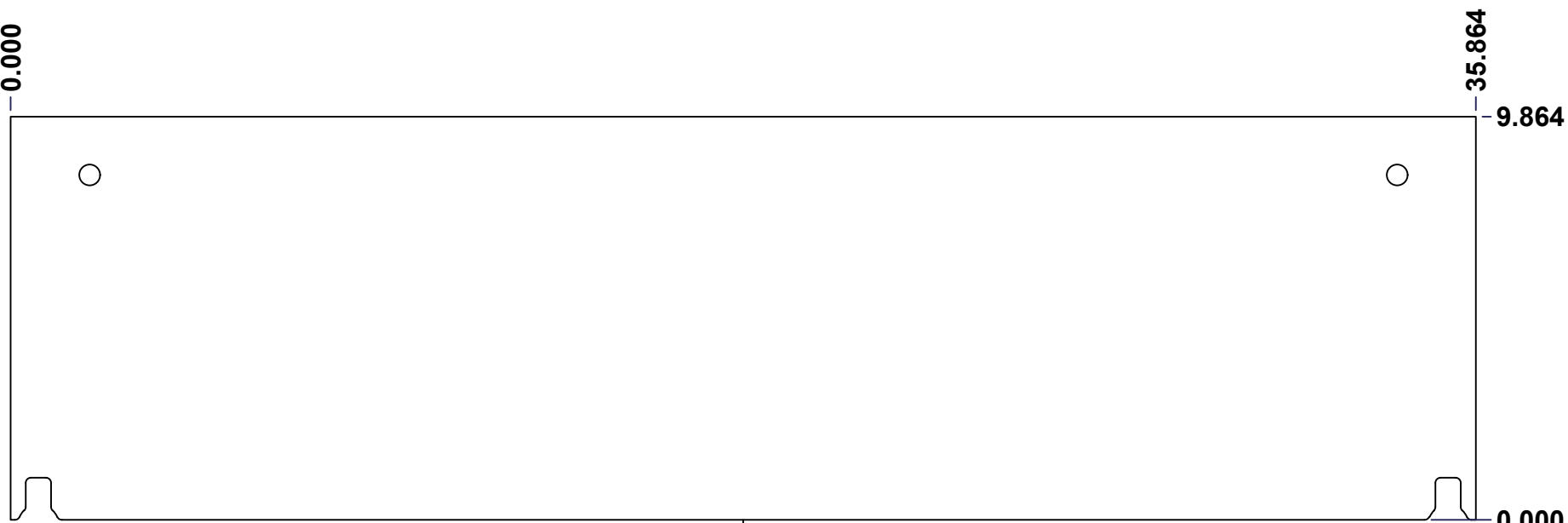

FRONT



RIGHT

No.	Revisions	Date	By/Par

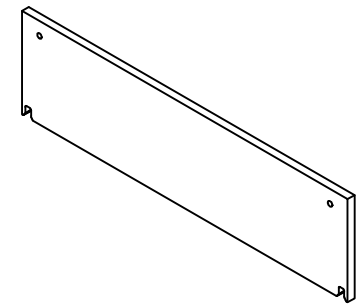

Isometric View



Tél: (450) 979-4373
 Fax: (450) 979-4626
www.exmweb.com

Flatness
Aplatissement

Max 3.0mm

Projection

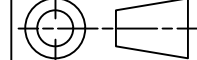

Customer Client	Date
Drawn By / Dessiné Par: BoxCad: Patrick Deschenes	Date: 23-Jan-07
Material / Matière: Polyisocyanurate	
Color / Couleur: Aluminum	Finish / Fini: N/A
Description: 5412ESW 48" x 36" Top and Bottom Insulation	Detail Rev.
Part Number / Numéro Pièce: 5412ESW483610THI-BT	Rev. 0

SEE BILL OF MATERIAL ON LAST PAGE

This drawing is confidential and must not be reproduced or used without the consent of EXM

Ce dessin est confidentiel et ne doit pas être reproduit ou utilisé sans le consentement de EXM

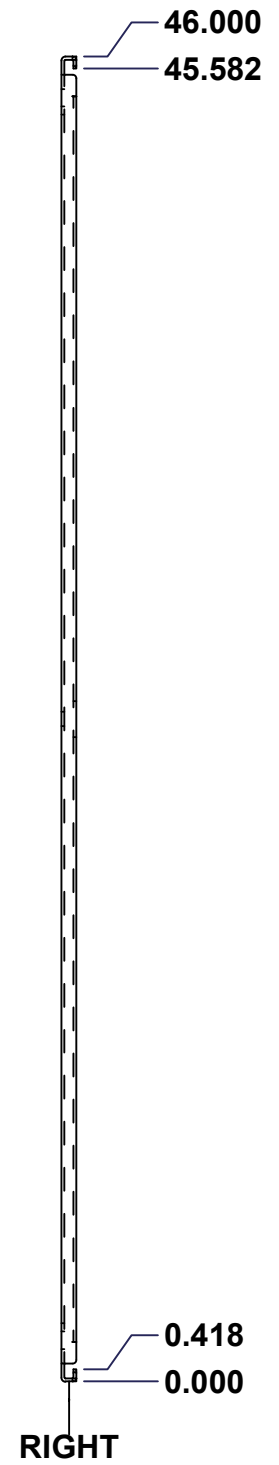
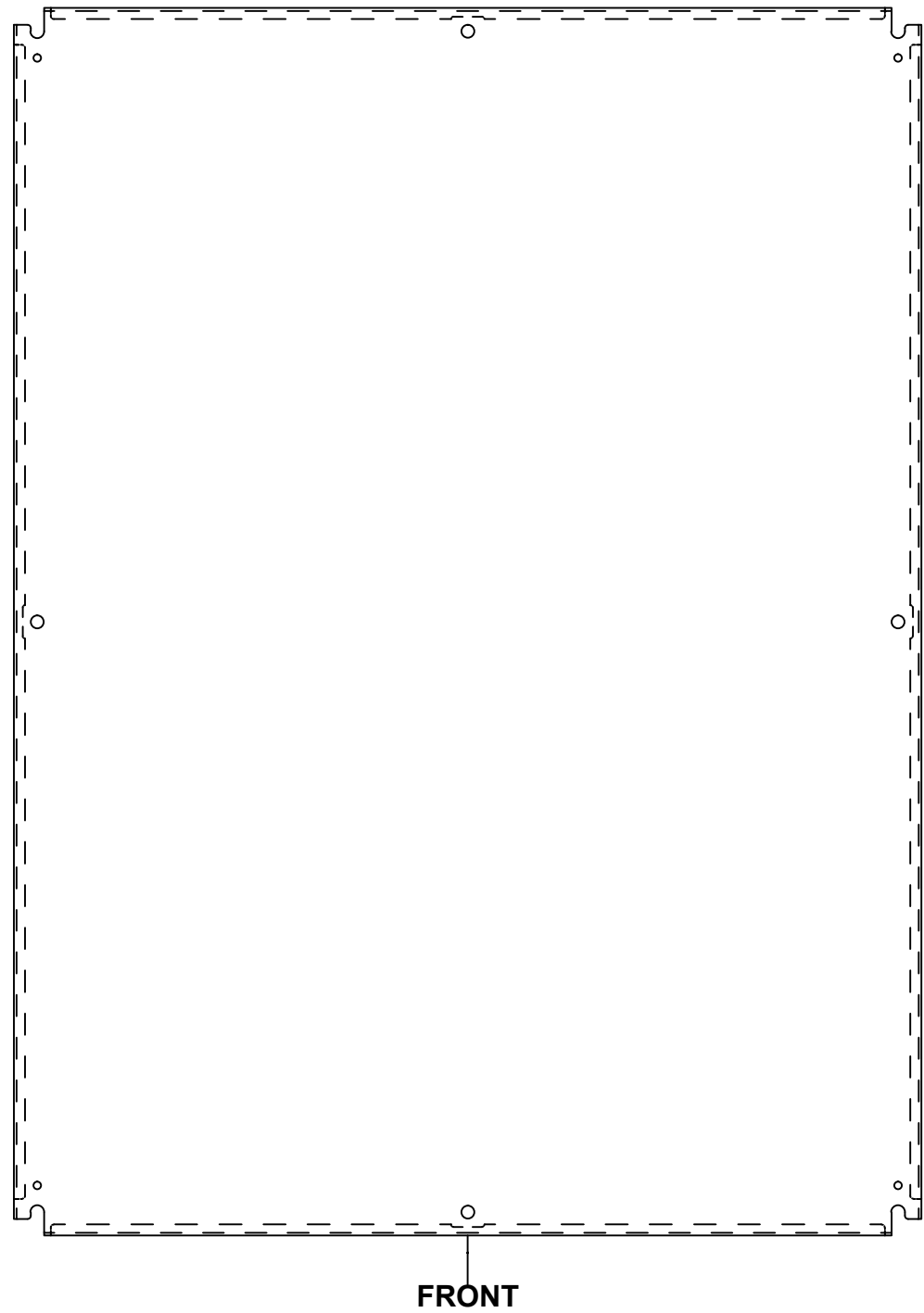
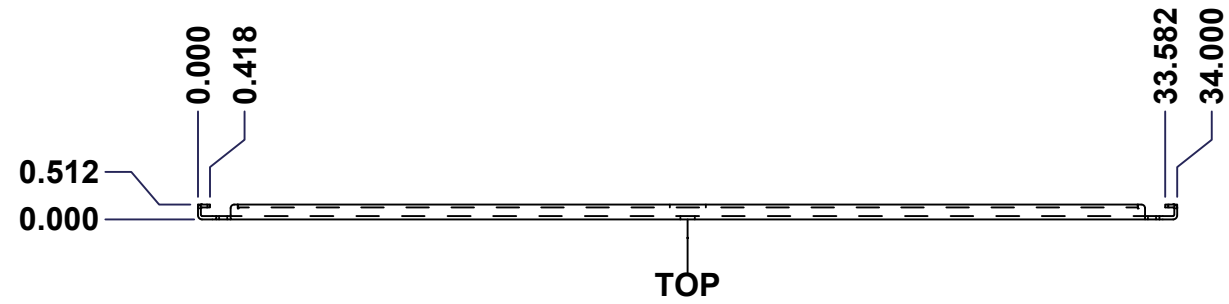

No.	Revisions	Date	By/Par

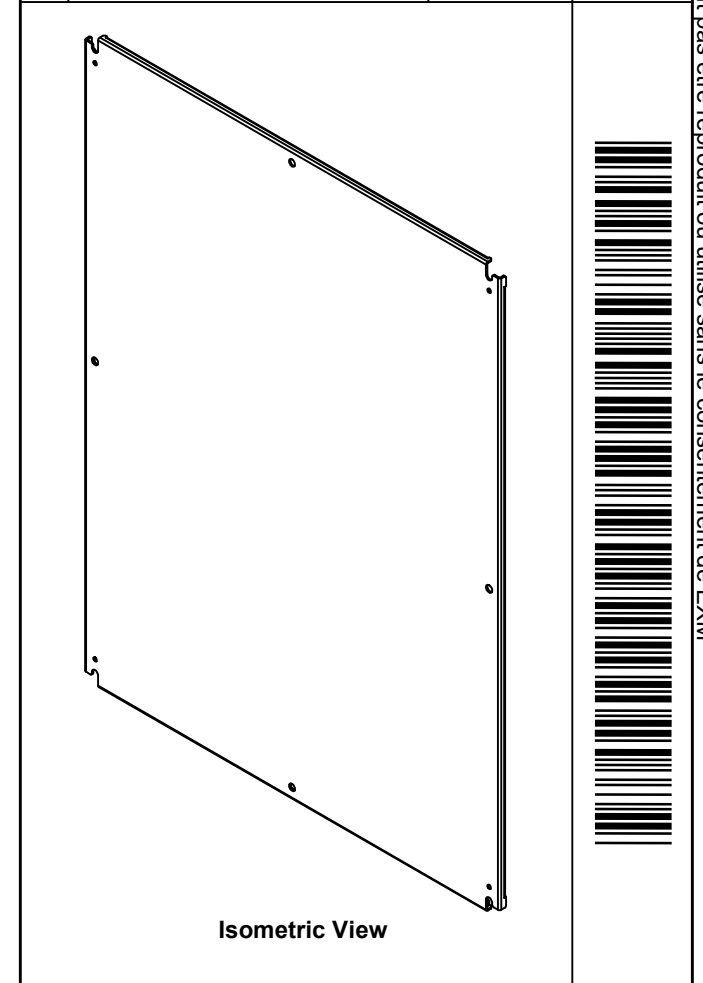

Tél: (450) 979-4373 Fax: (450) 979-4626 www.exmweb.com		Flatness Aplatissement Max 3.0mm Projection
Customer Client	Date	
Drawn By Dessiné Par	BoxCad	Date 23-Jan-07
Material Matière	See Part List	
Color Couleur	See Part List	Finish Fini See Part List
Description		Detail Rev.
881 SP - Inner Panel		
Part Number Numéro Pièce	881 SP4836G	Rev. 1 0 2

Qty	Part Number	Rev	Description	Material	Color	Finish
1	881 SP4836G-P	0	881 SP - Inner Panel Part	12 Ga Galvanized	Unpainted	Galvanized

Parts List

This drawing is confidential and must not be reproduced or used without the consent of EXM

Ce dessin est confidentiel et ne doit pas être reproduit ou utilisé sans le consentement de EXM

Table 1			FRONT VIEW
CUT-OUT	XDIM	YDIM	DESCRIPTION
1	17.000	0.875	MTG STUD HOLE (RND Ø0.500)
2	0.875	23.000	MTG STUD HOLE (RND Ø0.500)
3	33.125	23.000	MTG STUD HOLE (RND Ø0.500)
4	17.000	45.125	MTG STUD HOLE (RND Ø0.500)
5	0.875	1.875	GROUND HOLE (RND Ø0.290)
6	33.125	1.875	GROUND HOLE (RND Ø0.290)
7	0.875	44.125	GROUND HOLE (RND Ø0.290)
8	33.125	44.125	GROUND HOLE (RND Ø0.290)

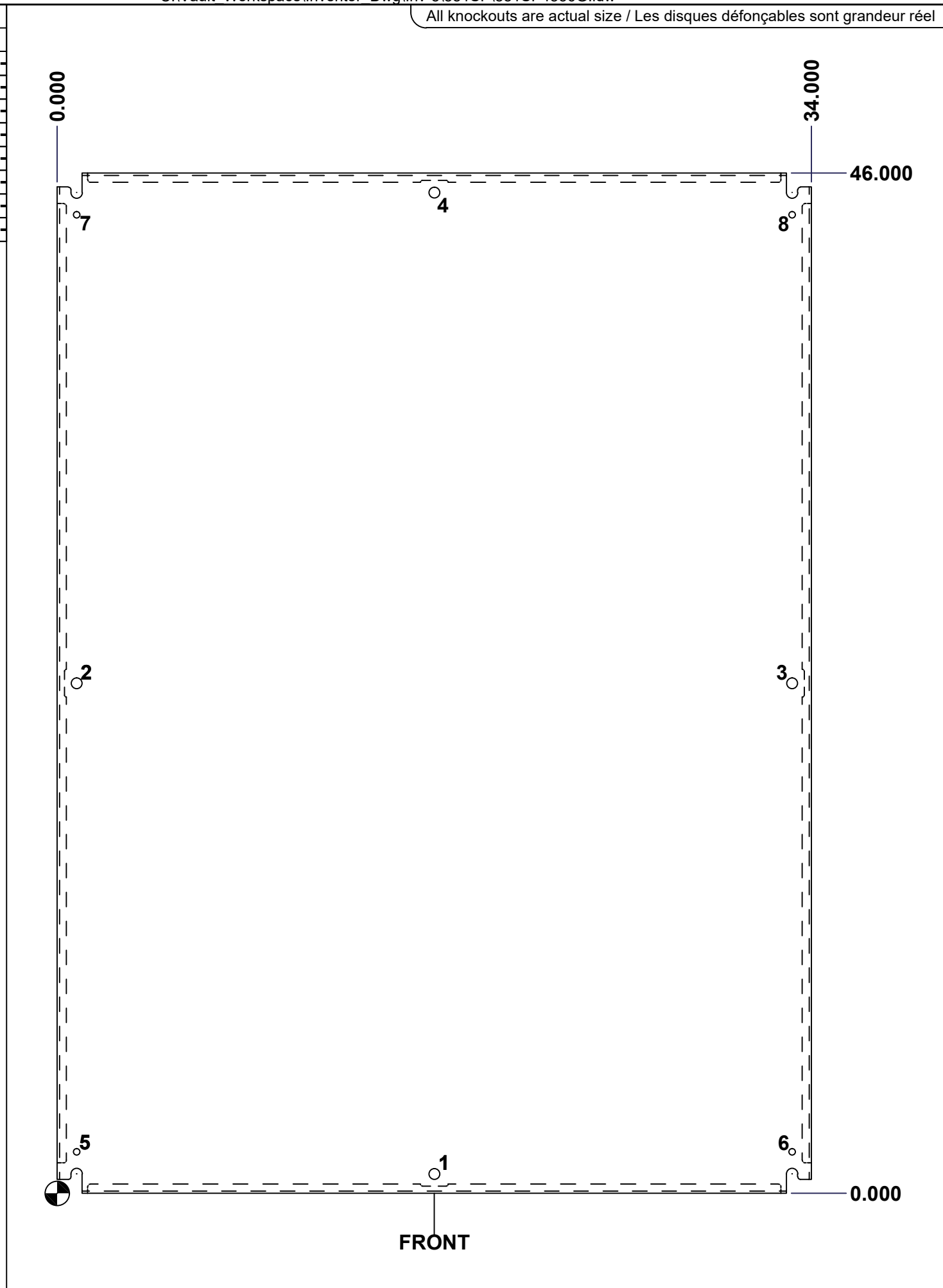

All knockouts are actual size / Les disques défonçables sont grandeur réel

No.	Revisions	Date	By/Par

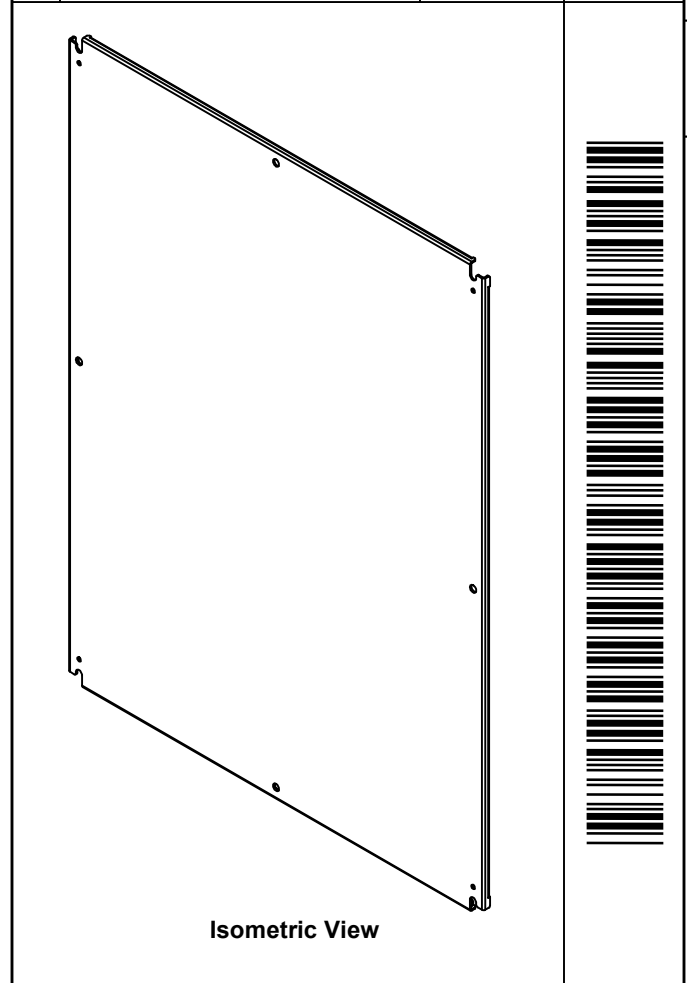

	Tél: (450) 979-4373 Fax: (450) 979-4626 www.exmweb.com	Flatness Aplatissement Max 3.0mm
		Projection
Customer Client		Date
Drawn By Dessiné Par	BoxCad	Date 23-Jan-07
Material Matière	See Part List	
Color Couleur	See Part List	Finish Fini See Part List
Description 881 SP - Inner Panel		Detail Rev.
Part Number Numéro Pièce	881 SP4836G	Rev. 2 0