

This drawing is confidential and must not be reproduced or used without the consent of EXM

Ce dessin est confidentiel et ne doit pas être reproduit ou utilisé sans le consentement de EXM

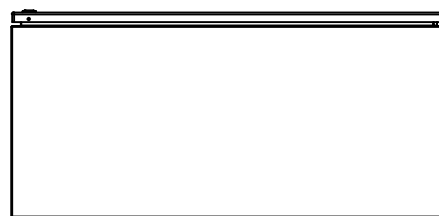

TOP

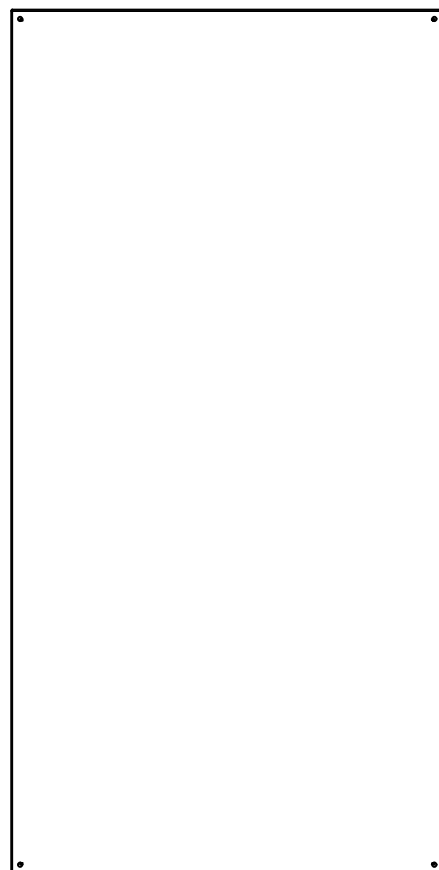

BACK

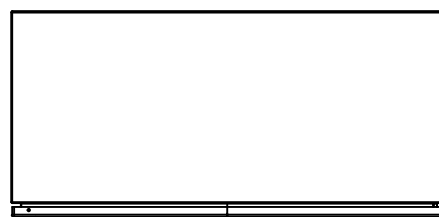

BOTTOM

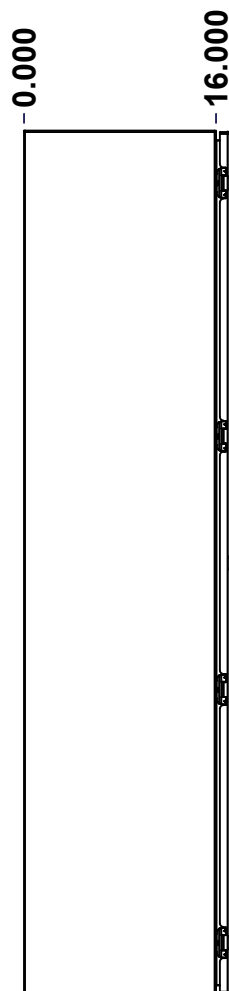

LEFT

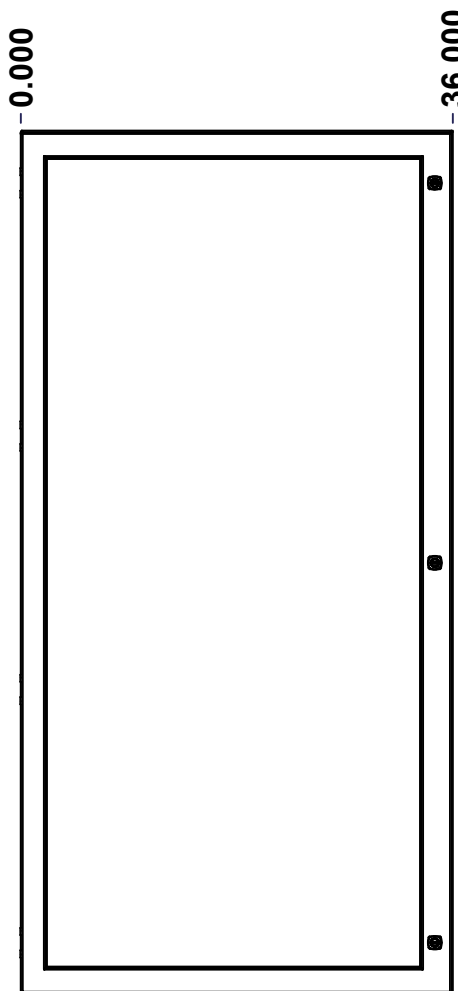

FRONT

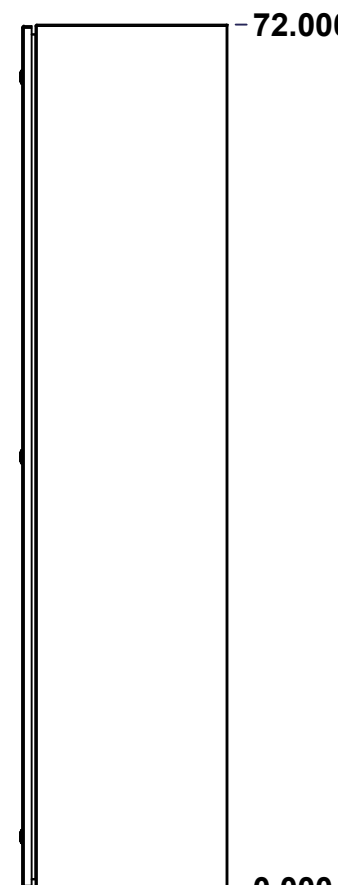

RIGHT

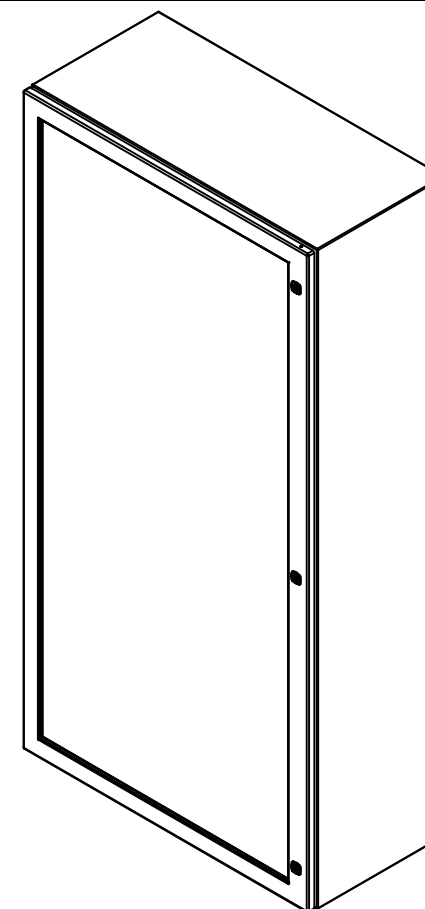

Isometric View



No.	Revisions	Date	By/Par

 Tél: (450) 979-4373 Fax: (450) 979-4626 <a href="http://www.exmweb.com">www.exmweb.com</a>		Flatness Aplatissement  Max 3.0mm Projection 
Customer Client	Date	
Drawn By Dessiné Par	BoxCad: BoxCad	Date 14-Mar-23
Material Matière	14 Ga Cold Rolled A1008 CS Type B (1.7mm)	
Color Couleur	Asa-61 Grey	Finish Fini Smooth
Description	Detail Rev.	
5412ESW 72" x 36" x 16" Assembly		
Part Number Numéro Pièce	Rev. 0	1 9

SEE BILL OF MATERIAL ON LAST PAGE

**5412ESW723616NOIP**

This drawing is confidential and must not be reproduced or used without the consent of EXM

Ce dessin est confidentiel et ne doit pas être reproduit ou utilisé sans le consentement de EXM

NOTE	
ITEM	DESCRIPTION
1	NEMA 4/12 Enclosure
2	C/W Standard ground studs on box and cover
3	W/O Standard door stiffener
4	W/O Inner panel
5	C/W Standard inner panel mounting studs

No.	Revisions	Date	By/Par

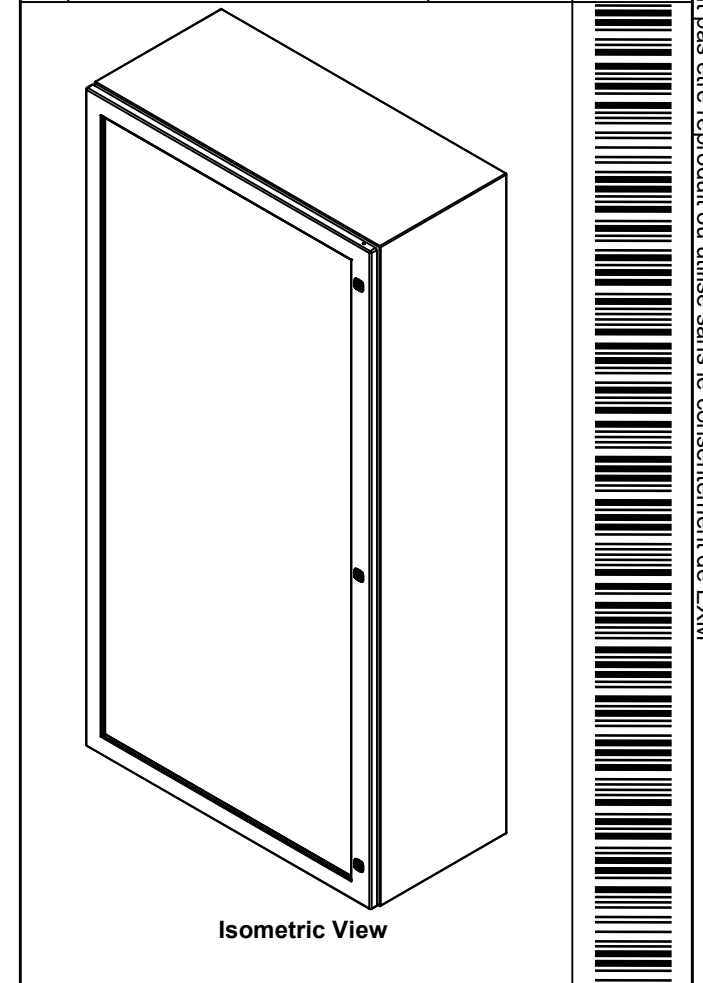

PACKING		
ITEM	QTY	DESCRIPTION
Cardboard sleeve	2	Top and Bottom
Cardboard strip	2	Between back of enclosure and inner panel
Plastic bag	1	To protect cover surface and inside gasket
Cardboard corner	4	To reinforced for the plastic strap tightening
Plastic strap - Black	2	To Squeeze the 2 cardboard sleeve together
Packaging label	3	White label with PN
Plastic strap- Green	2	To secure the enclosure to the wood pallet
Wood Pallet	1	2" deeper and 3" larger than enclosure size

1	STK-K-01800	5	5412 ES Accessory Kit
1	5412ESW723616NOIPC	0	5412ESW 72" x 36" Cover
1	5412ESW723616NOIPB	0	5412ESW 72" x 36" x 16" Body
4	STK-Q-04050-08	0	M6 x 8mm Hexagon Socket Head Machine Screw
Qty	Part Number	Rev	Description
Parts List			

	Flatness Aplatissement Max 3.0mm
	Projection 
Customer Client	Date
Drawn By Dessiné Par BoxCad: BoxCad	Date 14-Mar-23
Material Matière 14 Ga Cold Rolled A1008 CS Type B (1.7mm)	
Color Couleur Asa-61 Grey	Finish Fini Smooth
Description 5412ESW 72" x 36" x 16" Assembly	
Part Number Numéro Pièce <b>5412ESW723616NOIP</b>	Rev. 0 2 9

This drawing is confidential and must not be reproduced or used without the consent of EXM

Ce dessin est confidentiel et ne doit pas être reproduit ou utilisé sans le consentement de EXM

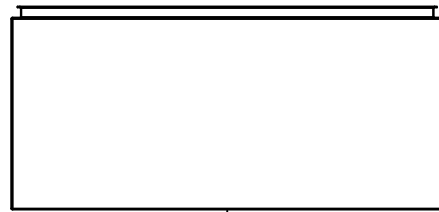

TOP

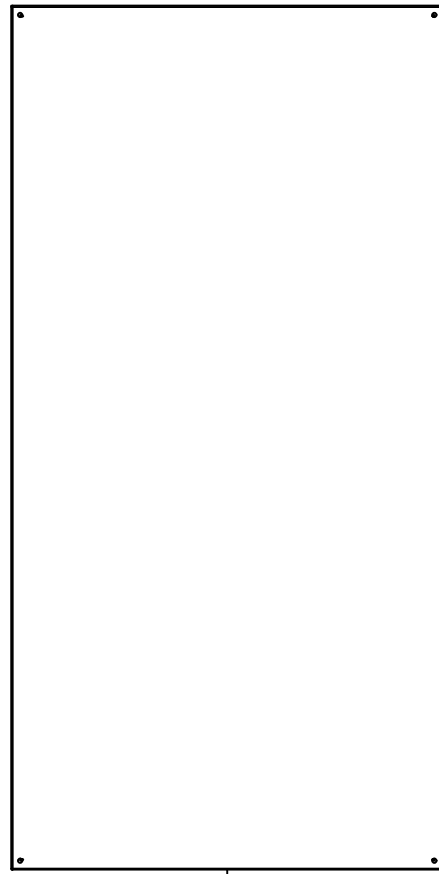

BACK



BOTTOM

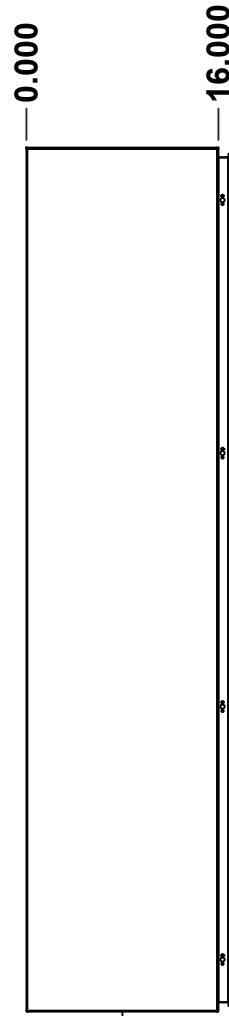

LEFT

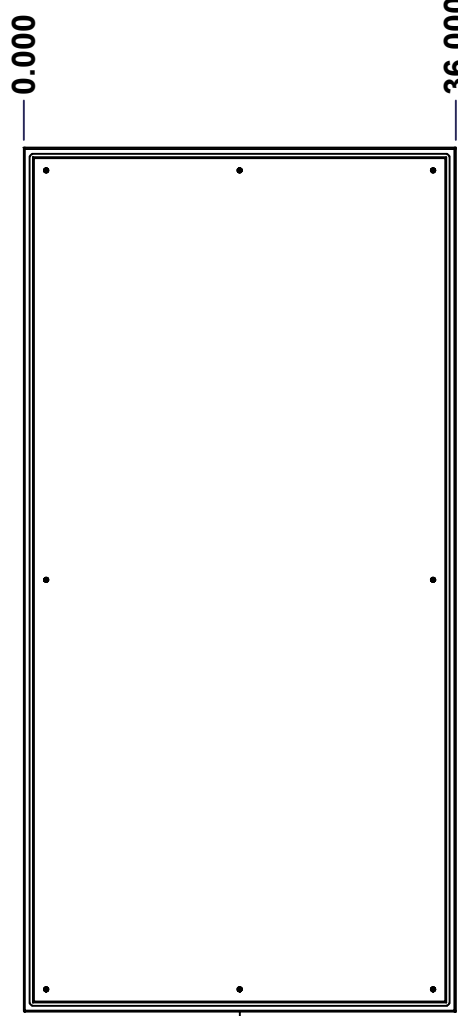

FRONT

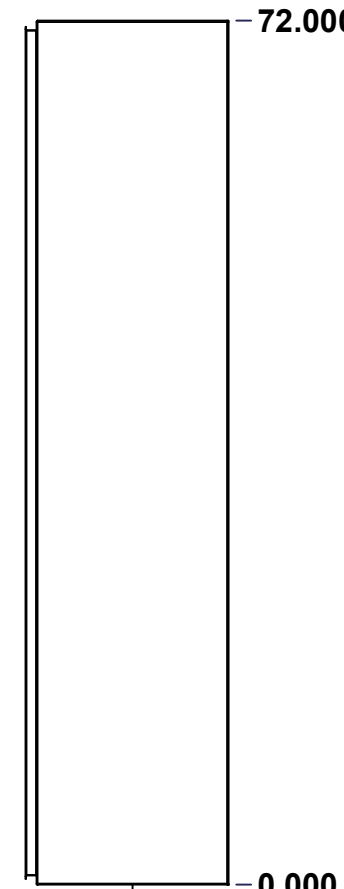

RIGHT

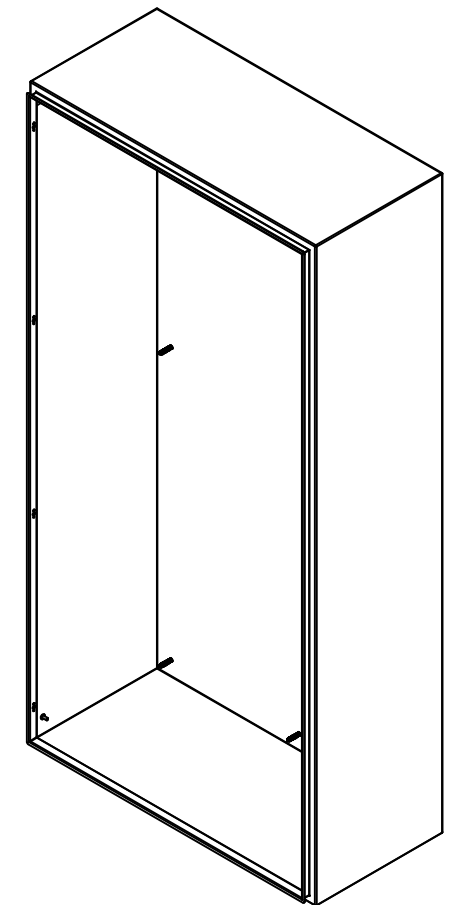

Isometric View

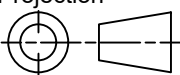

No.	Revisions	Date	By/Par

 Tél: (450) 979-4373 Fax: (450) 979-4626 <a href="http://www.exmweb.com">www.exmweb.com</a>		Flatness Aplatissement Max 3.0mm Projection 
Customer Client	Date	
Drawn By Dessiné Par	BoxCad: BoxCad	Date 14-Mar-23
Material Matière	14 Ga Cold Rolled A1008 CS Type B (1.7mm)	
Color Couleur	Asa-61 Grey	Finish Fini Smooth
Description	Detail Rev.	
5412ESW 72" x 36" x 16" Body		
Part Number Numéro Pièce	Rev. 0	3 9
<b>SEE BILL OF MATERIAL ON LAST PAGE 5412ESW723616NOIPB</b>		

This drawing is confidential and must not be reproduced or used without the consent of EXM

Ce dessin est confidentiel et ne doit pas être reproduit ou utilisé sans le consentement de EXM

STANDARD FEATURES ARE NOT LISTED IN THIS HOLE TABLE			
HOLE TABLE - LEFT VIEW (CUSTOM FEATURE ONLY)			
CUT-OUT	XDIM	YDIM	DESCRIPTION
1	14.500	2.000	GND STUD M6 x 16mm (Inside)
2	14.000	70.000	LABEL_EXM (Inside)

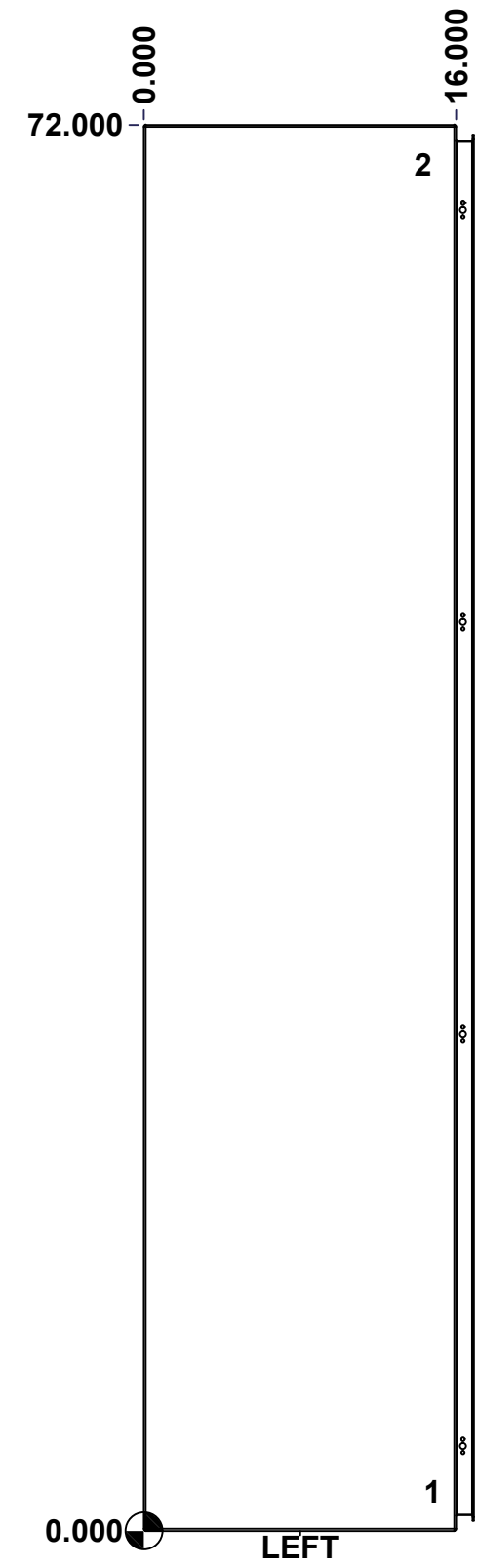

	Description	Status	
	5412ESW 72" x 36" x 16" Body	(NULL)	
	Part Number Numéro Pièce	Rev.	
	<b>5412ESW723616NOIPB</b>	<b>0</b>	4/9

This drawing is confidential and must not be reproduced or used without the consent of EXM

Ce dessin est confidentiel et ne doit pas être reproduit ou utilisé sans le consentement de EXM

**STANDARD FEATURES ARE NOT LISTED IN THIS HOLE TABLE**

**HOLE TABLE - BACK VIEW (CUSTOM FEATURE ONLY)**

CUT-OUT	XDIM	YDIM	DESCRIPTION
1	1.875	1.875	IP STUD M8 x 35mm (Inside)
2	1.875	70.125	IP STUD M8 x 35mm (Inside)
3	34.125	70.125	IP STUD M8 x 35mm (Inside)
4	34.125	1.875	IP STUD M8 x 35mm (Inside)
5	1.875	36.000	IP STUD M8 x 35mm (Inside)
6	34.125	36.000	IP STUD M8 x 35mm (Inside)
7	18.000	1.875	IP STUD M8 x 35mm (Inside)
8	18.000	70.125	IP STUD M8 x 35mm (Inside)
-----			
9	35.250	0.750	RND Ø0.390
10	35.250	71.250	RND Ø0.390
11	0.750	71.250	RND Ø0.390
12	0.750	0.750	RND Ø0.390

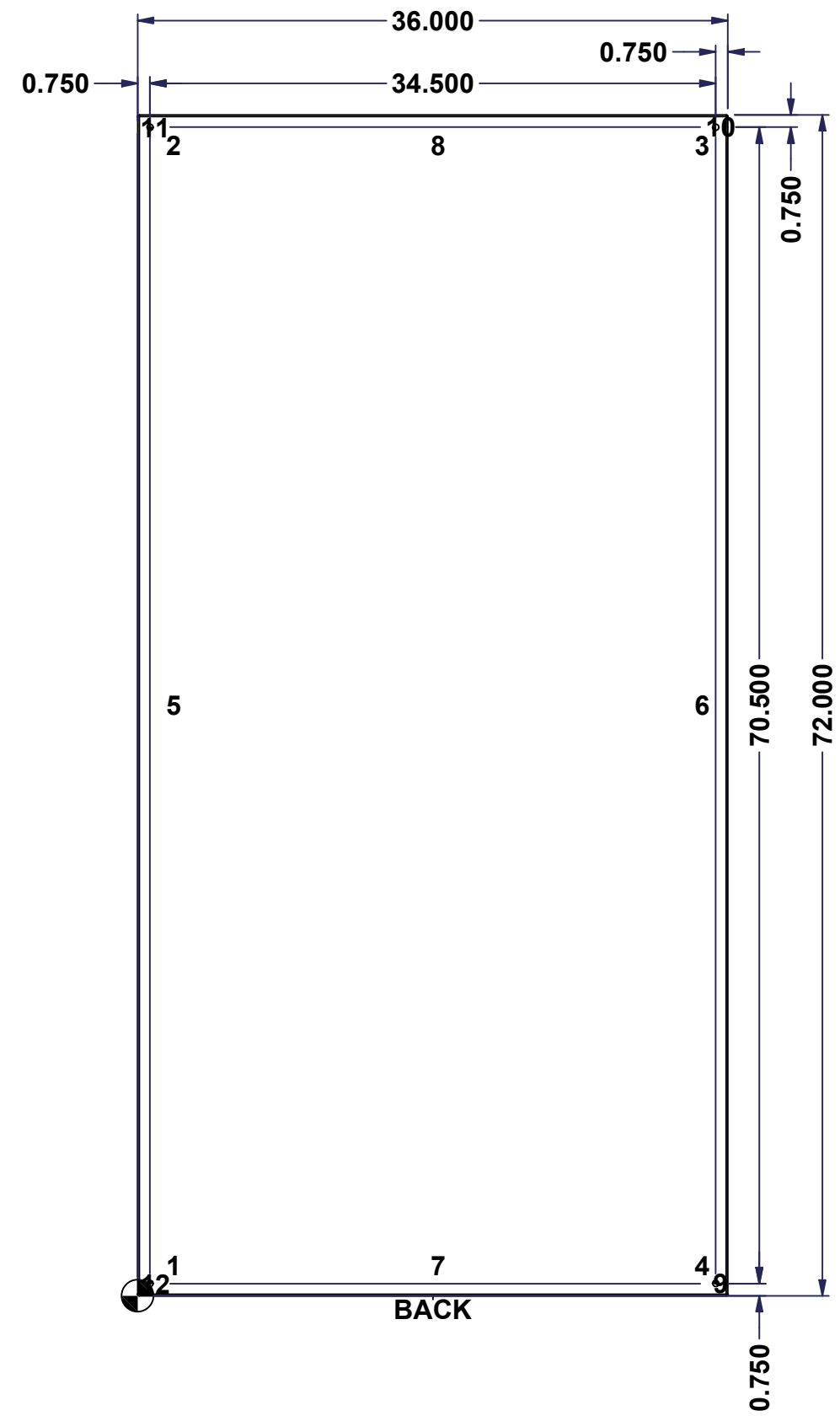

BACK

	Description	Status
	5412ESW 72" x 36" x 16" Body	(NULL)
	Part Number Numéro Pièce	Rev.
	5412ESW723616NOIPB	5
		0
		9

This drawing is confidential and must not be reproduced or used without the consent of EXM

Ce dessin est confidentiel et ne doit pas être reproduit ou utilisé sans le consentement de EXM

No.	Revisions	Date	By/Par

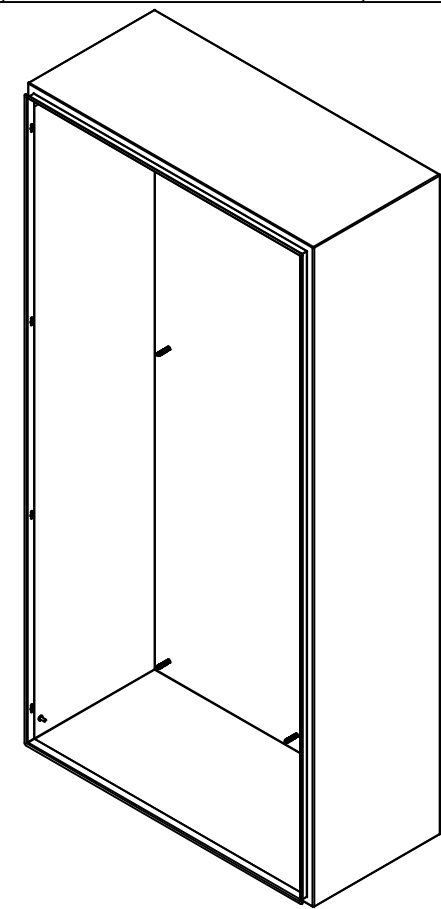

Isometric View

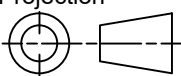

 Tél: (450) 979-4373 Fax: (450) 979-4626 <a href="http://www.exmweb.com">www.exmweb.com</a>		Flatness Aplatissement Max 3.0mm Projection 
Customer Client	Date	
Drawn By Dessiné Par	BoxCad: BoxCad	Date 14-Mar-23
Material Matière	14 Ga Cold Rolled A1008 CS Type B (1.7mm)	
Color Couleur	Asa-61 Grey	Finish Fini Smooth
Description		Detail Rev.
5412ESW 72" x 36" x 16" Body		
Part Number Numéro Pièce	Rev.	6
<b>5412ESW723616NOIPB</b>	<b>0</b>	9

Qty	Part Number	Rev	Description
1	STK-S-00100	0	3.5" x 2" Silver Milar Flexcon Sticker
1	STK-Q-16080	0	Ground Stud M6 x 16mm Steel
1	STK-P-02400S	0	Powder Paint (Asa-61 Grey / Smooth)
8	STK-Q-16005	1	Stud M8 x 35 (No Paint Cap Required)
1	5412ESW723616NOIPB-P	0	5412ESW 72" x 36" x 16" Body Part
Parts List			

This drawing is confidential and must not be reproduced or used without the consent of EXM

Ce dessin est confidentiel et ne doit pas être reproduit ou utilisé sans le consentement de EXM

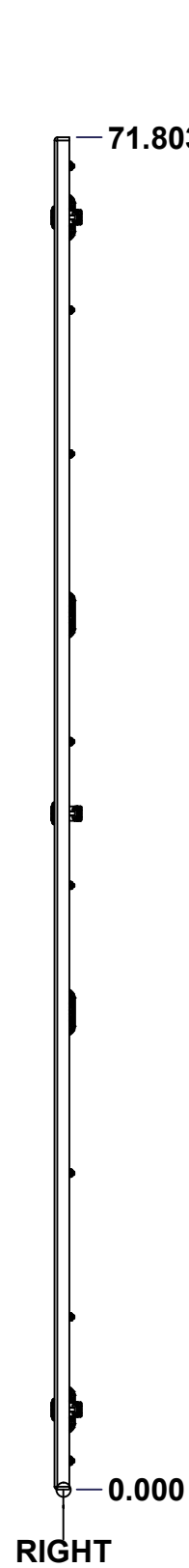
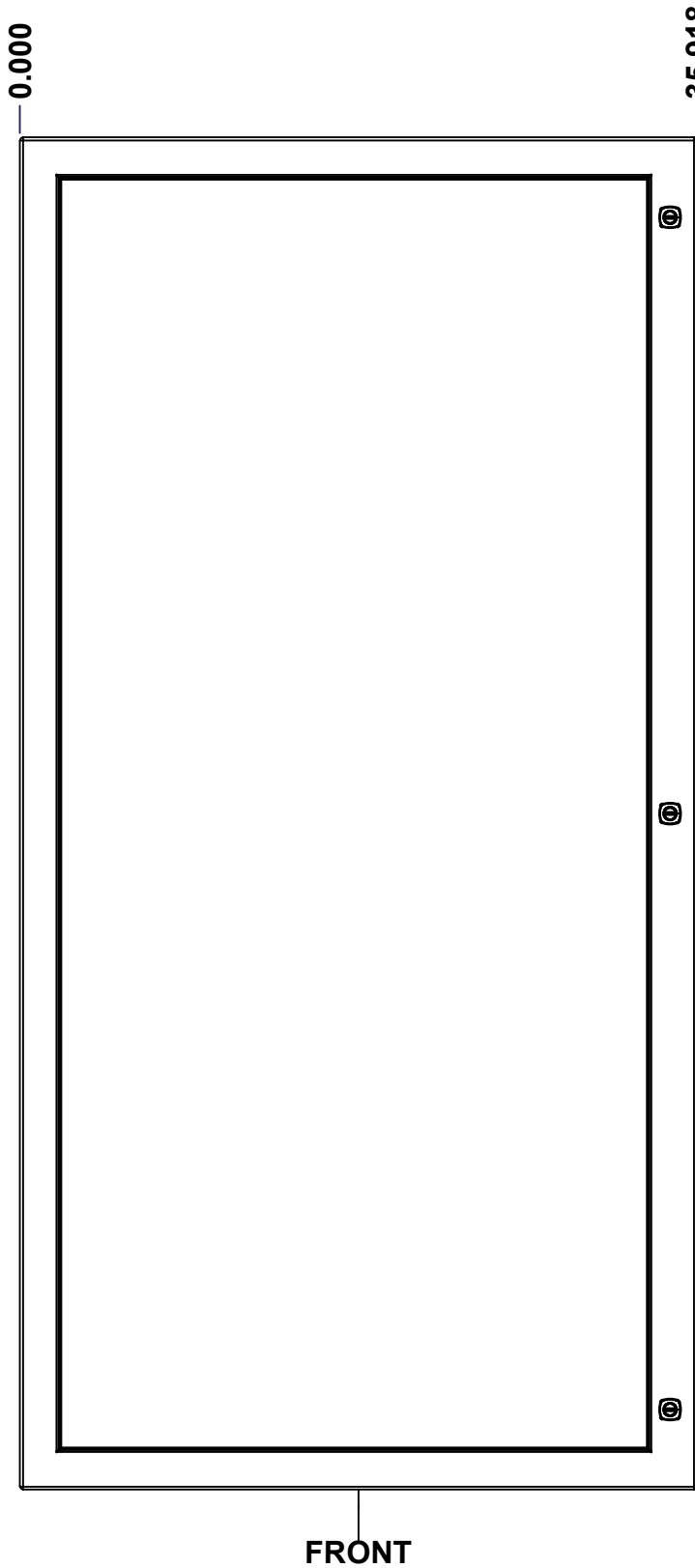
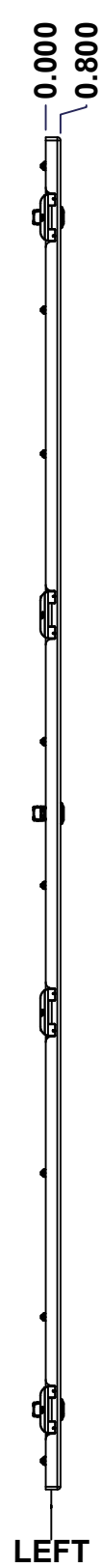
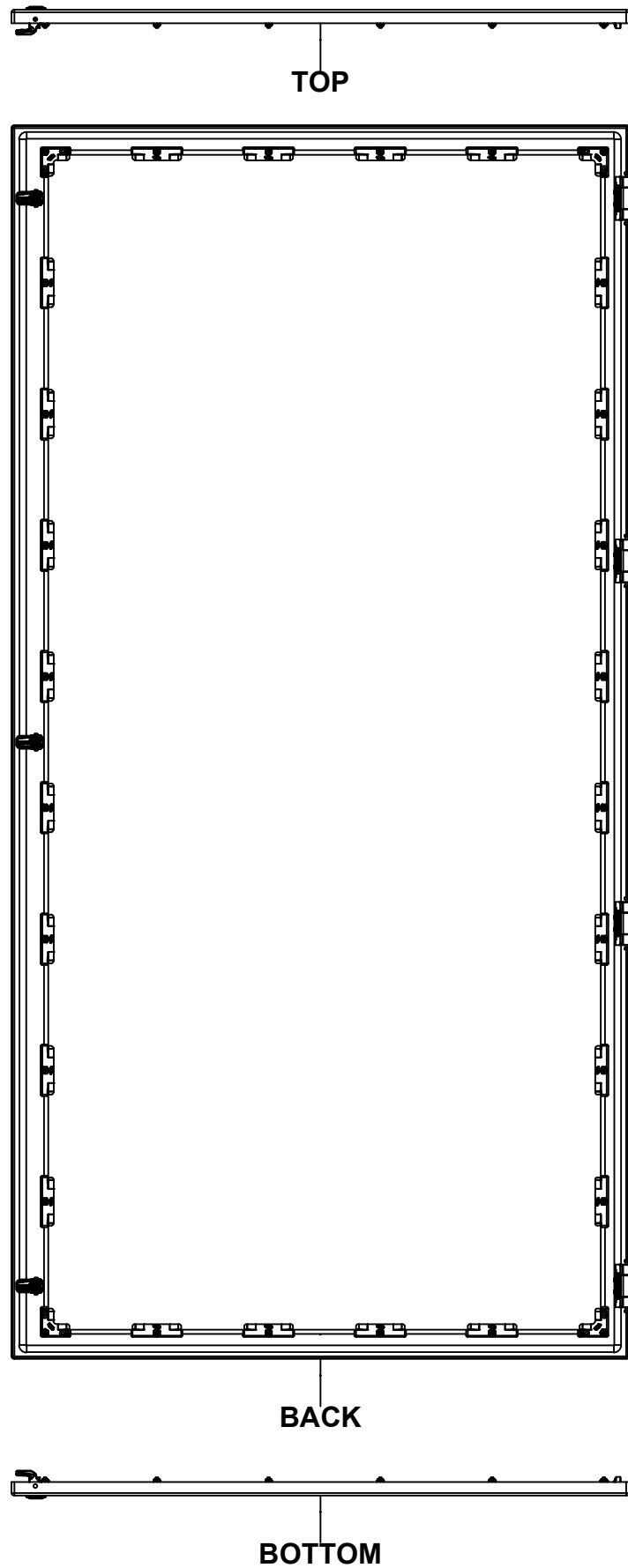

No.	Revisions	Date	By/Par

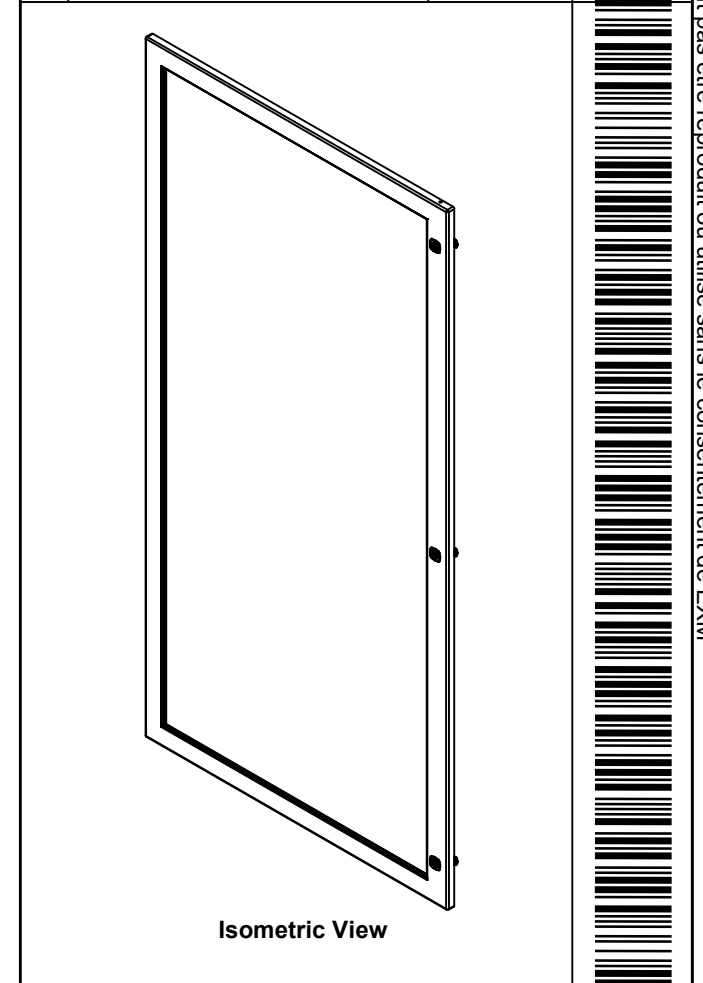

<p>Tél: (450) 979-4373                  Fax: (450) 979-4626  <a href="http://www.exmweb.com">www.exmweb.com</a></p>	Flatness Aplatissement Max 3.0mm
	Projection 
Customer Client	Date
Drawn By Dessiné Par BoxCad: BoxCad	Date 14-Mar-23
Material Matière 14 Ga Cold Rolled A1008 CS Type B (1.7mm)	
Color Couleur Asa-61 Grey	Finish Fini Smooth
Description 5412ESW 72" x 36" Cover	Detail Rev.
Part Number Numéro Pièce <b>5412ESW723616NOIPC</b>	Rev. <b>0</b>

SEE BILL OF MATERIAL ON LAST PAGE

7  
9

This drawing is confidential and must not be reproduced or used without the consent of EXM

Ce dessin est confidentiel et ne doit pas être reproduit ou utilisé sans le consentement de EXM

STANDARD FEATURES ARE NOT LISTED IN THIS HOLE TABLE			
HOLE TABLE - FRONT VIEW (CUSTOM FEATURE ONLY)			
CUT-OUT	XDIM	YDIM	DESCRIPTION
1	1.469	9.166	STUD M6 x 18mm (Inside)
2	33.968	9.166	STUD M6 x 18mm (Inside)
3	1.469	16.805	STUD M6 x 18mm (Inside)
4	33.968	16.805	STUD M6 x 18mm (Inside)
5	1.469	24.443	STUD M6 x 18mm (Inside)
6	33.968	24.443	STUD M6 x 18mm (Inside)
7	1.469	32.082	STUD M6 x 18mm (Inside)
8	33.968	32.082	STUD M6 x 18mm (Inside)
9	1.469	39.721	STUD M6 x 18mm (Inside)
10	33.968	39.721	STUD M6 x 18mm (Inside)
11	1.469	47.360	STUD M6 x 18mm (Inside)
12	33.968	47.360	STUD M6 x 18mm (Inside)
13	1.469	54.998	STUD M6 x 18mm (Inside)
14	33.968	54.998	STUD M6 x 18mm (Inside)
15	1.469	62.637	STUD M6 x 18mm (Inside)
16	33.968	62.637	STUD M6 x 18mm (Inside)
17	1.469	70.276	STUD M6 x 18mm (Inside)
18	1.469	1.527	STUD M6 x 18mm (Inside)
19	7.969	70.276	STUD M6 x 18mm (Inside)
20	7.969	1.527	STUD M6 x 18mm (Inside)
21	14.469	70.276	STUD M6 x 18mm (Inside)
22	14.469	1.527	STUD M6 x 18mm (Inside)
23	20.968	70.276	STUD M6 x 18mm (Inside)
24	20.968	1.527	STUD M6 x 18mm (Inside)
25	27.468	70.276	STUD M6 x 18mm (Inside)
26	27.468	1.527	STUD M6 x 18mm (Inside)
27	33.968	70.276	STUD M6 x 18mm (Inside)
28	33.968	1.527	STUD M6 x 18mm (Inside)
-----			
29	34.494	4.250	880 SCQ4-SL
30	34.494	67.553	880 SCQ4-SL
31	34.494	35.902	880 SCQ4-SL

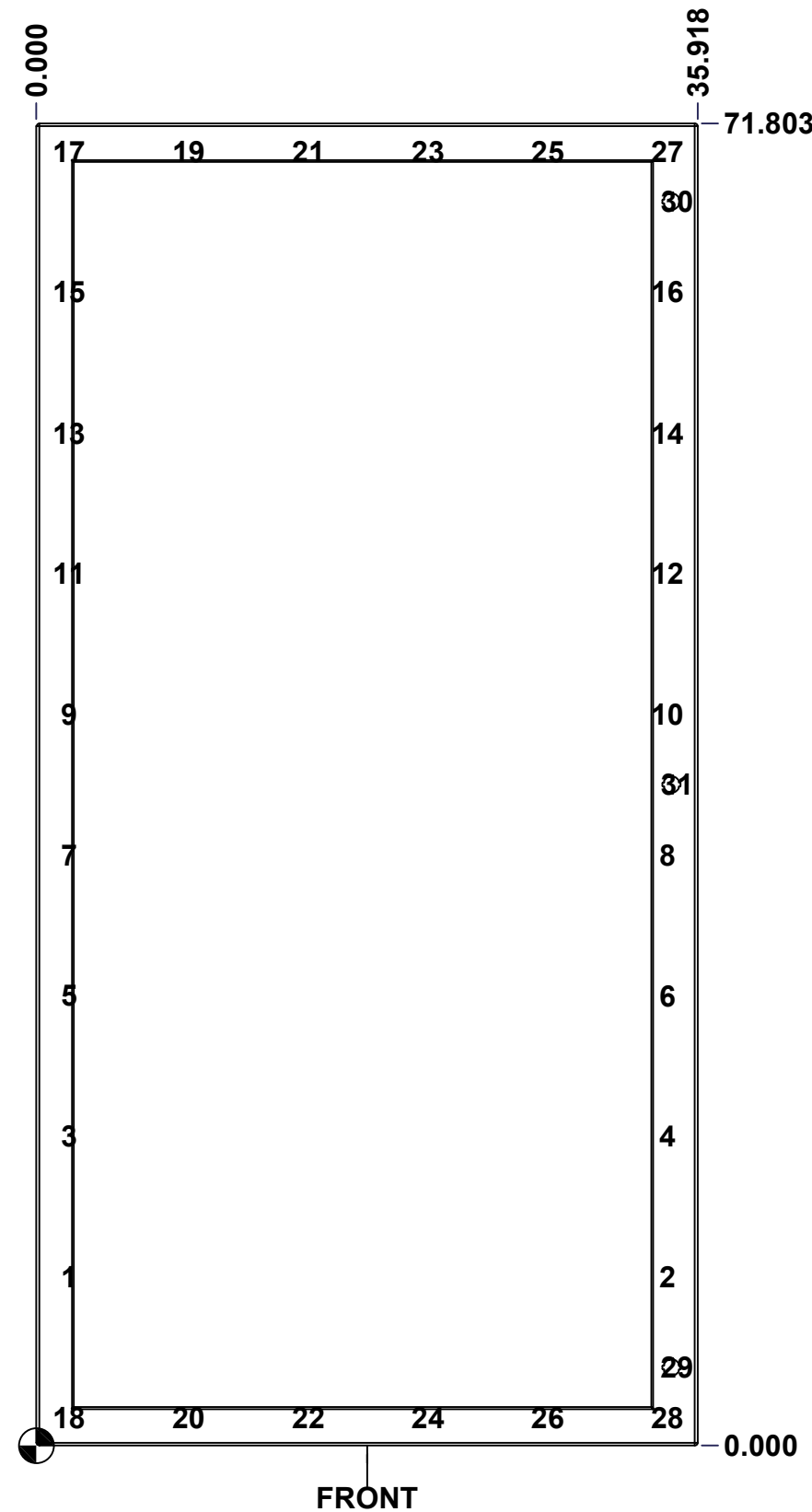

	Description	Status	
	5412ESW 72" x 36" Cover	(NULL)	
	Part Number	Rev.	8
	Numéro Pièce	<b>0</b>	9
	<b>5412ESW723616NOIPC</b>		



This drawing is confidential and must not be reproduced or used without the consent of EXM

Ce dessin est confidentiel et ne doit pas être reproduit ou utilisé sans le consentement de EXM

No.	Revisions	Date	By/Par

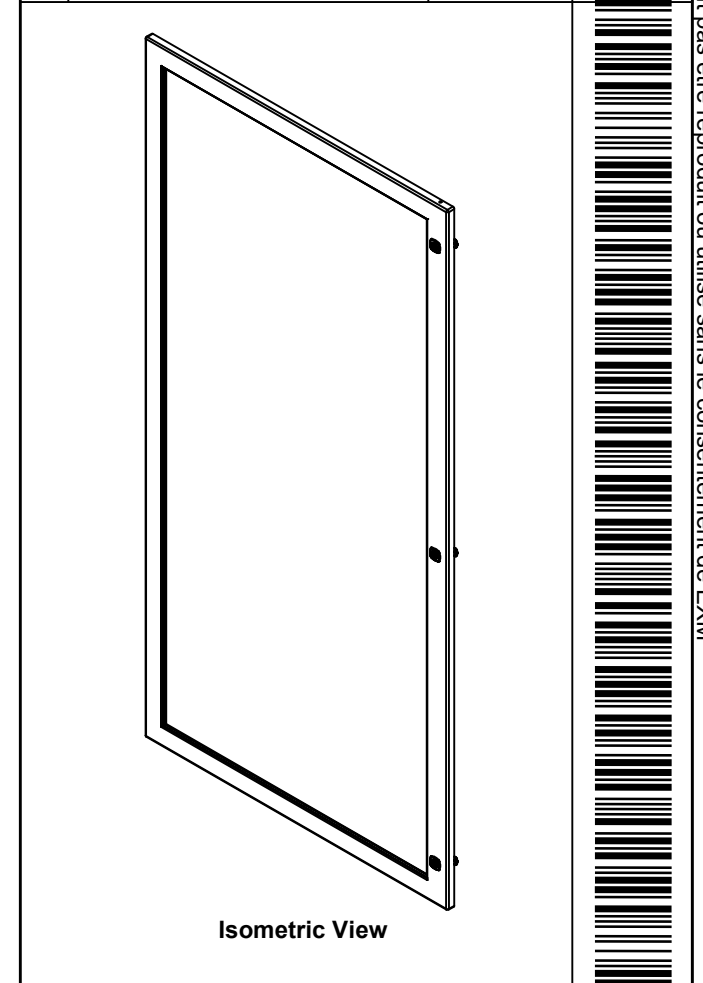

1	STK-P-02400S	0	Powder Paint (Asa-61 Grey / Smooth)
24	STK-Q-60701	2.1	880 WK - Lexan 1/4" Fixing Bracket
1	STK-A-60703	0	5412 ESW Lexan Bracket Kit
28	STK-Q-16052	0	M6 x 23mm Stud (No Paint Cap Required)
1	STK-G-02710	0	880 HWKG - Windows Kit Gasket
1	5412ESW723616NOIPLX G	0	5412ESW 72" x 36" Lexan Gasket Part
1	5412ESW723616NOIPLX	0	5412ESW 68.375" x 32.125" Lexan Part
1	5412ESW723616NOIPG	0	5412ESW 72" x 36" Cover Gasket Part
1	5412ESW723616NOIPC-P	0	5412ESW 72" x 36" Cover Part
4	STK-K-09800	10	5412 ES Hinge with 2 Captive Hinge Pins
3	STK-K-12500	16	5412 ES 1/4 Turn Lock
Qty	Part Name	Rev	Description
Parts List			

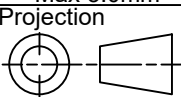
 Tél: (450) 979-4373 Fax: (450) 979-4626 <a href="http://www.exmweb.com">www.exmweb.com</a>		Flatness Aplatissement Max 3.0mm Projection 
Customer Client	Date	
Drawn By Dessiné Par	BoxCad: BoxCad	Date 14-Mar-23
Material Matière	14 Ga Cold Rolled A1008 CS Type B (1.7mm)	
Color Couleur	Asa-61 Grey	Finish Fini Smooth
Description		Detail Rev.
5412ESW 72" x 36" Cover		
Part Number Numéro Pièce	Rev.	9
<b>5412ESW723616NOIPC</b>	<b>0</b>	9