

This drawing is confidential and must not be reproduced or used without the consent of EXM

Ce dessin est confidentiel et ne doit pas être reproduit ou utilisé sans le consentement de EXM

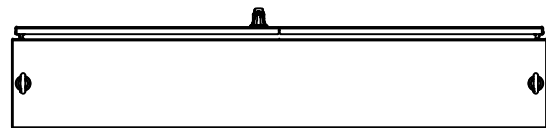

TOP

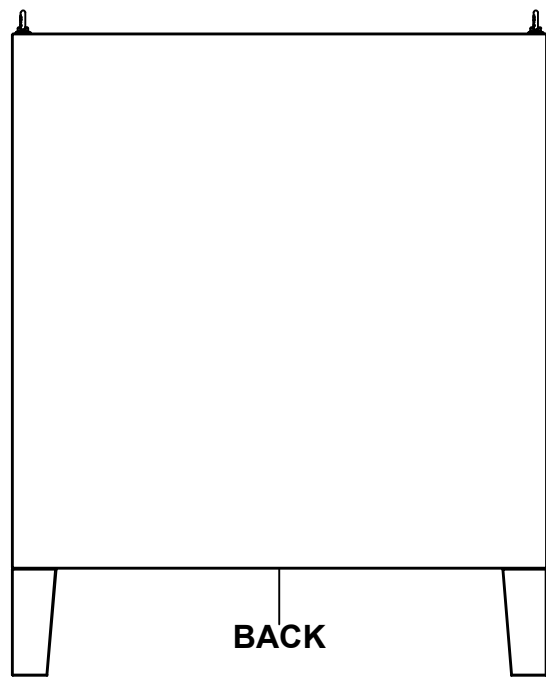

BACK

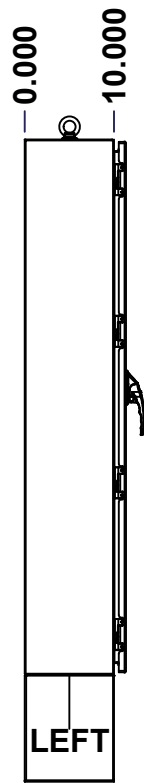

LEFT

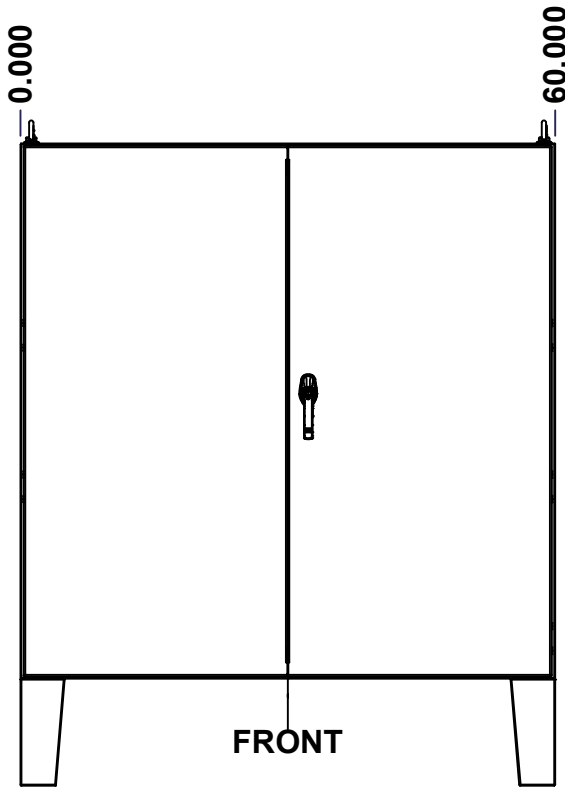

FRONT

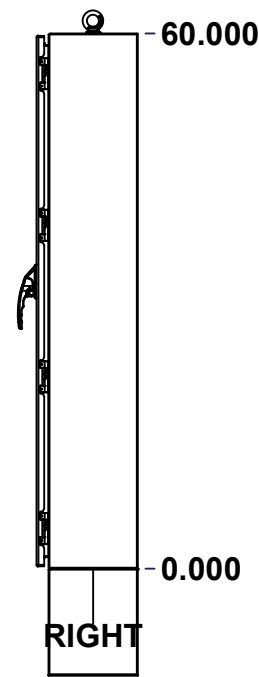

RIGHT

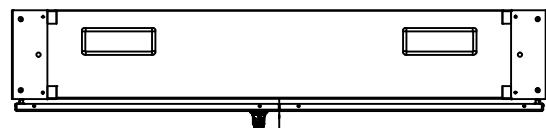

BOTTOM

No.	Revisions	Date	By/Par

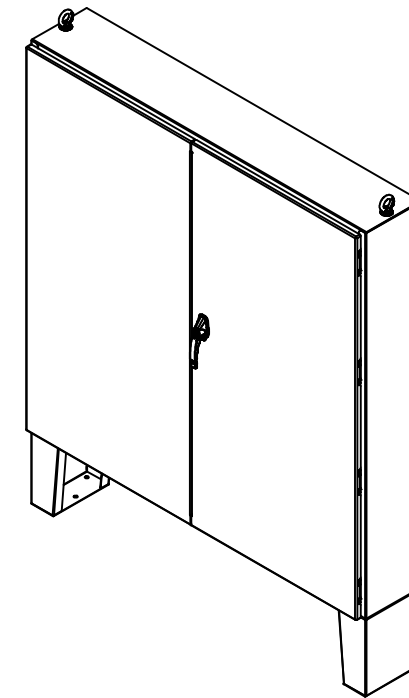

Isometric View



Tél: (450) 979-4373  
 Fax: (450) 979-4626  
[www.exmweb.com](http://www.exmweb.com)

Flatness  
Aplatissement

Max 3.0mm

Projection

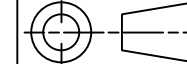

Customer Client	Date
Drawn By Dessiné Par	Date 09-Sep-14

Material  
Matière 12 Ga Cold Rolled A1008 CS Type B (2.5mm)

Color  
Couleur Asa-61 Grey

Finish  
Fini Smooth

Description  
5500DDS 60" x 60" x 10" Assembly

Detail Rev.

Part Number Numéro Pièce	Rev.	1
<b>5500DDS606010</b>	<b>0</b>	17

SEE BILL OF MATERIAL ON LAST PAGE

This drawing is confidential and must not be reproduced or used without the consent of EXM

Ce dessin est confidentiel et ne doit pas être reproduit ou utilisé sans le consentement de EXM

NOTE	
ITEM	DESCRIPTION
1	NEMA 12, 13 Enclosure (IP55)
2	C/W Standard ground studs on box and cover
3	C/W Standard door stiffener
4	C/W Standard inner panel (Included)
5	C/W Standard inner panel mounting studs
6	C/W Eyebolts sold separately (Installed by EXM)
7	C/W Mounting feet sold separately (Installed)
8	C/W Struts installed (Included)

No.	Revisions	Date	By/Par

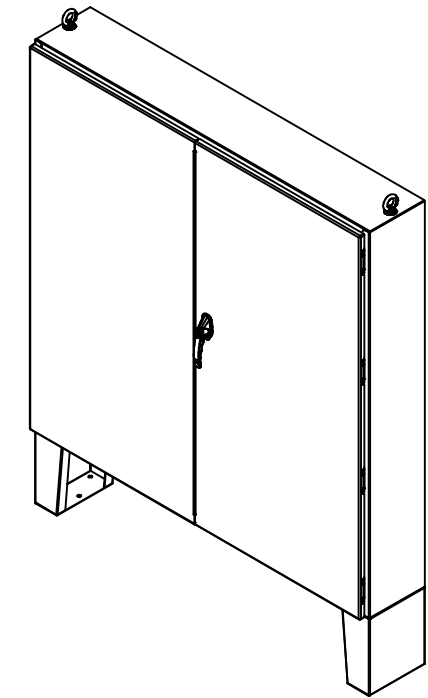

Isometric View



Tél: (450) 979-4373  
 Fax: (450) 979-4626  
[www.exmweb.com](http://www.exmweb.com)

Flatness  
Aplatissement

Max 3.0mm

Projection

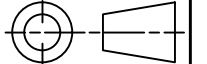

Customer Client	Date
Drawn By Dessiné Par	BoxCad: BoxCad Date 09-Sep-14
Material Matière	12 Ga Cold Rolled A1008 CS Type B (2.5mm)
Color Couleur	Asa-61 Grey Finish Fini Smooth
Description	Detail Rev.
5500DDS 60" x 60" x 10" Assembly	
Part Number Numéro Pièce	Rev. 2
<b>5500DDS606010</b>	<b>0</b>

Qty	Part Number	Rev	Description
1	5500DDS606010MF	0	885 MFHD 12" x 10" Mounting Feet
8	STK-Q-07320	0	Flange Lock Nut M10
1	885SP6060G	0	885 SP6060G Inner Panel
1	880EB14	2	Eye Bolt M14 (Pack of 2)
8	STK-Q-07620	0	M10 Plastic Spacer 0.875"
1	5500DDS606010FD	0	5500DDS 60" x 60" Cover
1	5500DDS606010LD	0	5500DDS 60" x 60" Cover
1	5500DDS606010B	0	5500DDS 60" x 60" x 10" Body
2	5500DDS606010GP	0	5500DDS Gland Plate
8	STK-Q-04050-10	8	M6 x 10mm Hexagon Socket Head Machine Screw with Nyseal
Parts List			

PACKING		
ITEM	QTY	DESCRIPTION
Cardboard sleeve	2	Top and Bottom
Cardboard strip	2	Between back of enclosure and inner panel
Plastic bag	1	To protect cover surface and inside gasket
Cardboard corner	4	To reinforced for the plastic strap tightening
Plastic strap - Black	2	To Squeeze 2 cardboard sleeve together
Packaging label	3	White label with PN
Plastic strap- Green	2	To secure the enclosure to the wood pallet
Wood Pallet	1	2" deeper and 3" larger than enclosure size

This drawing is confidential and must not be reproduced or used without the consent of EXM

Ce dessin est confidentiel et ne doit pas être reproduit ou utilisé sans le consentement de EXM

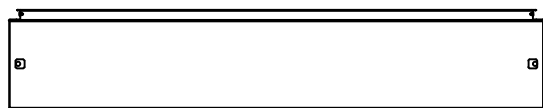

TOP

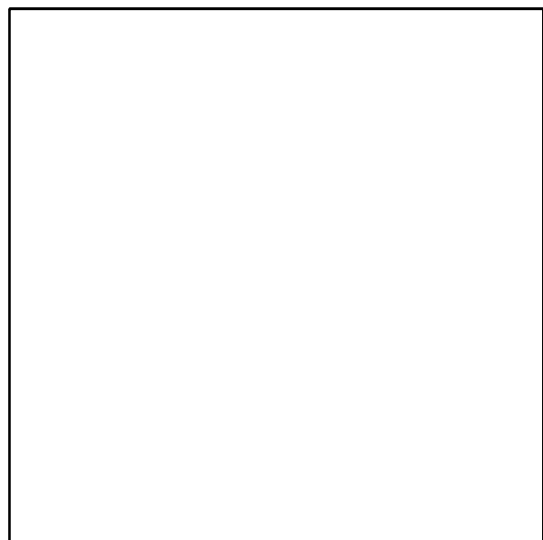

BACK

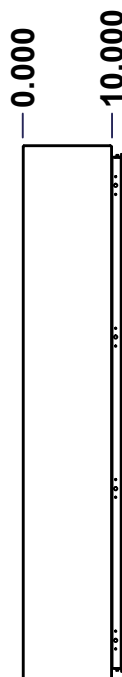

LEFT

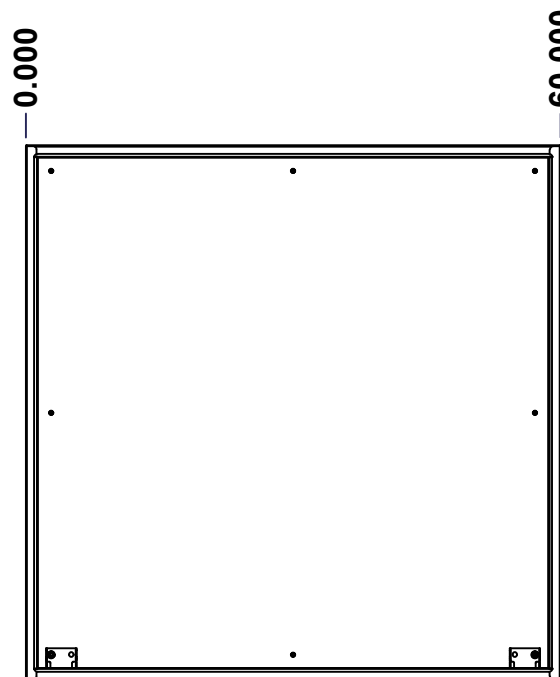

FRONT

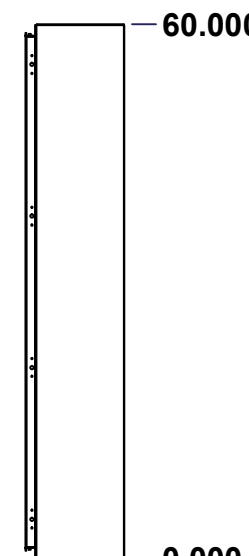

RIGHT

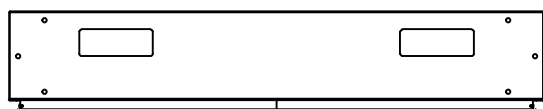

BOTTOM

No.	Revisions	Date	By/Par

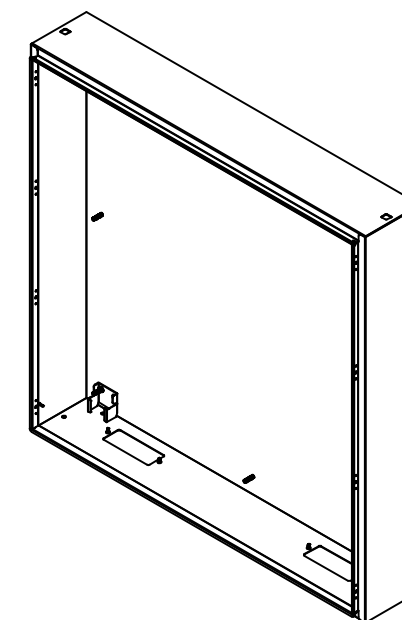

Isometric View



Tél: (450) 979-4373  
 Fax: (450) 979-4626  
[www.exmweb.com](http://www.exmweb.com)

Flatness  
Aplatissement

Max 3.0mm

Projection



Customer Client	Date
Drawn By Dessiné Par BoxCad: BoxCad	Date 09-Sep-14
Material Matière 12 Ga Cold Rolled A1008 CS Type B (2.5mm)	
Color Couleur Asa-61 Grey	Finish Fini Smooth
Description 5500DDS 60" x 60" x 10" Body	Detail Rev.
Part Number Numéro Pièce <b>5500DDS606010B</b>	Rev. 3 <b>0</b>

SEE BILL OF MATERIAL ON LAST PAGE

This drawing is confidential and must not be reproduced or used without the consent of EXM

Ce dessin est confidentiel et ne doit pas être reproduit ou utilisé sans le consentement de EXM

**STANDARD FEATURES ARE NOT LISTED IN THIS HOLE TABLE**

**HOLE TABLE - TOP VIEW (CUSTOM FEATURE ONLY)**

CUT-OUT	XDIM	YDIM	DESCRIPTION
1	44.911	5.911	Struts CR400 21.500" (Inside)
2	14.911	5.911	Struts CR400 21.500" (Inside)
3	44.911	6.840	STUDS M6 x 10mm (Inside)
4	55.777	5.911	STUDS M6 x 10mm (Inside)
5	14.911	6.840	STUDS M6 x 10mm (Inside)
6	25.777	5.911	STUDS M6 x 10mm (Inside)

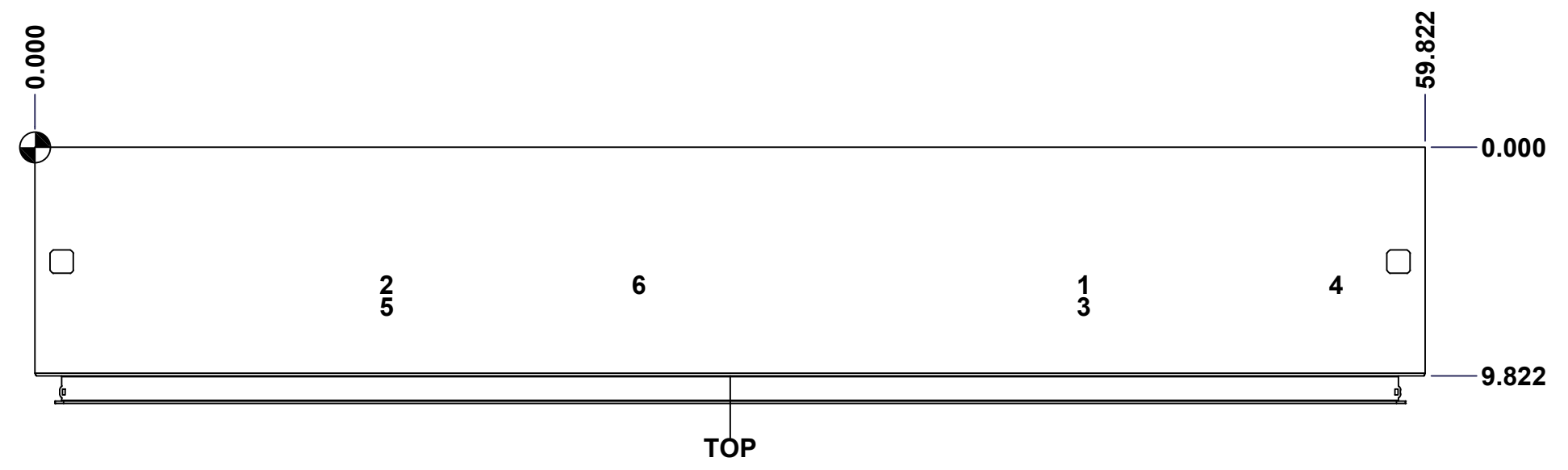

	Description	Status
	5500DDS 60" x 60" x 10" Body	(NULL)
Part Number Numéro Pièce <b>5500DDS606010B</b>	Rev.	4
	<b>0</b>	17

This drawing is confidential and must not be reproduced or used without the consent of EXM

Ce dessin est confidentiel et ne doit pas être reproduit ou utilisé sans le consentement de EXM

STANDARD FEATURES ARE NOT LISTED IN THIS HOLE TABLE			
HOLE TABLE - RIGHT VIEW (CUSTOM FEATURE ONLY)			
CUT-OUT	XDIM	YDIM	DESCRIPTION
1	8.411	3.286	GND STUD M6 x 16mm (Inside)

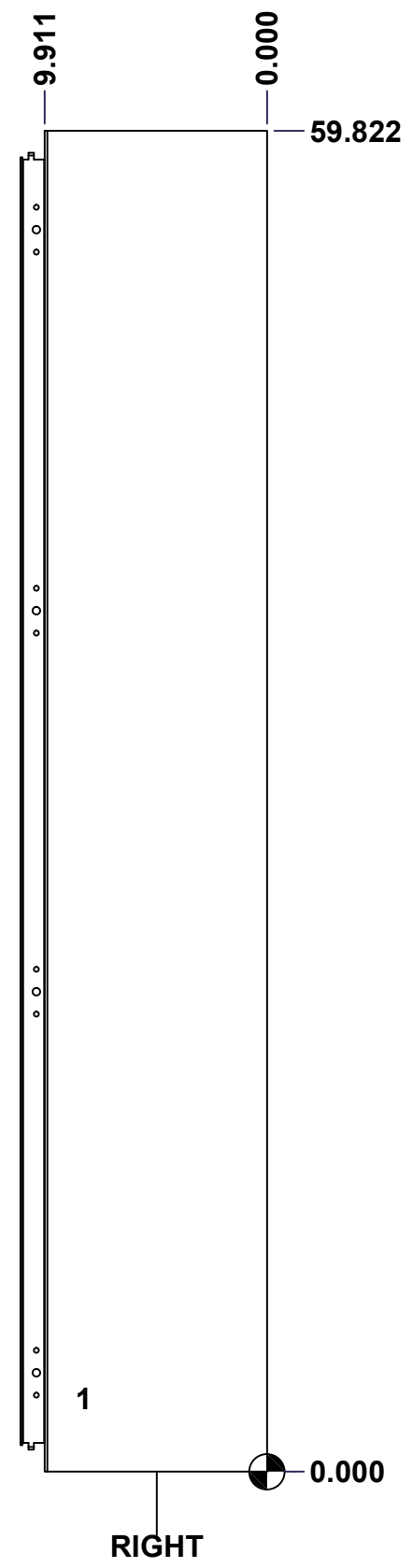

	Description	Status
	5500DDS 60" x 60" x 10" Body	(NULL)
	Part Number Numéro Pièce	Rev.
	<b>5500DDS606010B</b>	<b>0</b> / 5
		17

This drawing is confidential and must not be reproduced or used without the consent of EXM

Ce dessin est confidentiel et ne doit pas être reproduit ou utilisé sans le consentement de EXM

**STANDARD FEATURES ARE NOT LISTED IN THIS HOLE TABLE**

**HOLE TABLE - BOTTOM VIEW (CUSTOM FEATURE ONLY)**

CUT-OUT	XDIM	YDIM	DESCRIPTION
1	7.286	3.411	GP STUD M6 x 16mm (Inside)
2	16.536	3.411	GP STUD M6 x 16mm (Inside)
3	43.286	3.411	GP STUD M6 x 16mm (Inside)
4	52.536	3.411	GP STUD M6 x 16mm (Inside)
-----			
5	3.911	0.911	RND Ø0.500
6	0.911	4.911	RND Ø0.500
7	3.911	8.911	RND Ø0.500
8	55.911	0.911	RND Ø0.500
9	58.911	4.911	RND Ø0.500
10	55.911	8.911	RND Ø0.500

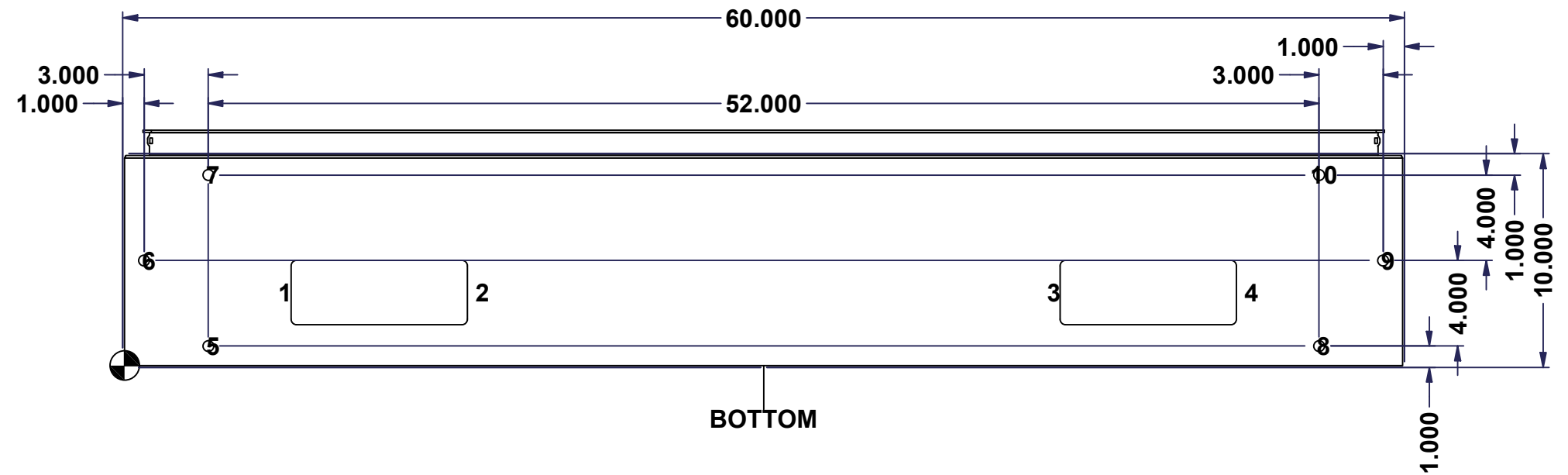

	Description	Status
	5500DDS 60" x 60" x 10" Body	(NULL)
	Part Number Numéro Pièce	Rev.
	<b>5500DDS606010B</b>	<b>0</b> / 6
		17

This drawing is confidential and must not be reproduced or used without the consent of EXM

Ce dessin est confidentiel et ne doit pas être reproduit ou utilisé sans le consentement de EXM

<b>STANDARD FEATURES ARE NOT LISTED IN THIS HOLE TABLE</b>			
<b>HOLE TABLE - LEFT VIEW (CUSTOM FEATURE ONLY)</b>			
CUT-OUT	XDIM	YDIM	DESCRIPTION
1	8.411	3.286	GND STUD M6 x 16mm (Inside)

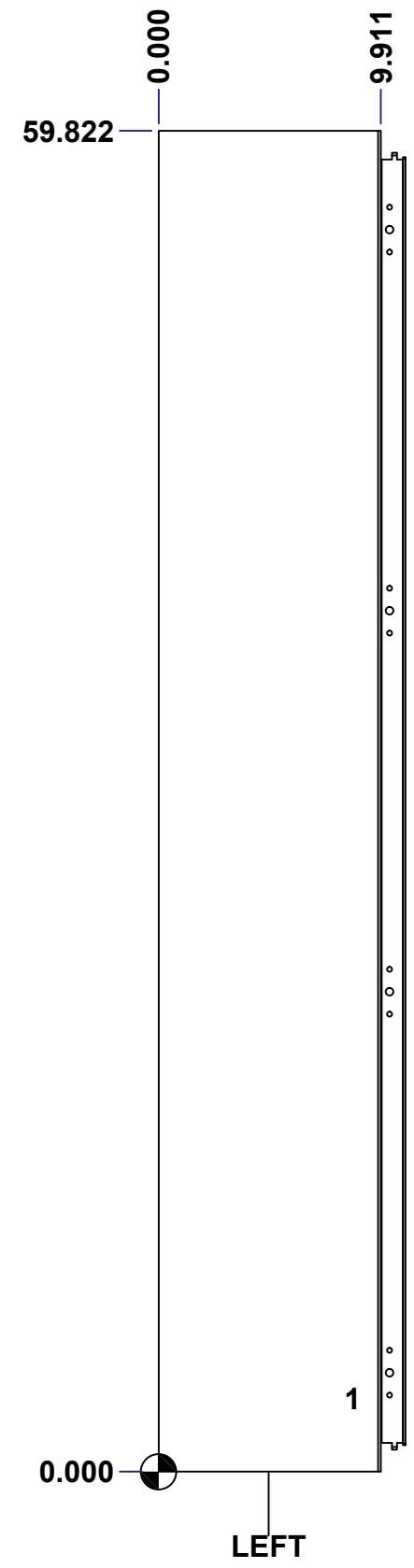

	Description	Status	
	5500DDS 60" x 60" x 10" Body	(NULL)	
	Part Number Numéro Pièce	Rev.	7
	<b>5500DDS606010B</b>	<b>0</b>	17

This drawing is confidential and must not be reproduced or used without the consent of EXM

Ce dessin est confidentiel et ne doit pas être reproduit ou utilisé sans le consentement de EXM

**STANDARD FEATURES ARE NOT LISTED IN THIS HOLE TABLE**

**HOLE TABLE - BACK VIEW (CUSTOM FEATURE ONLY)**

CUT-OUT	XDIM	YDIM	DESCRIPTION
1	2.786	2.786	IP STUD M10 x 40mm (Inside)
2	57.036	2.786	IP STUD M10 x 40mm (Inside)
3	2.786	29.911	IP STUD M10 x 40mm (Inside)
4	57.036	29.911	IP STUD M10 x 40mm (Inside)
5	2.786	57.036	IP STUD M10 x 40mm (Inside)
6	57.036	57.036	IP STUD M10 x 40mm (Inside)
7	29.911	2.786	IP STUD M10 x 40mm (Inside)
8	29.911	57.036	IP STUD M10 x 40mm (Inside)

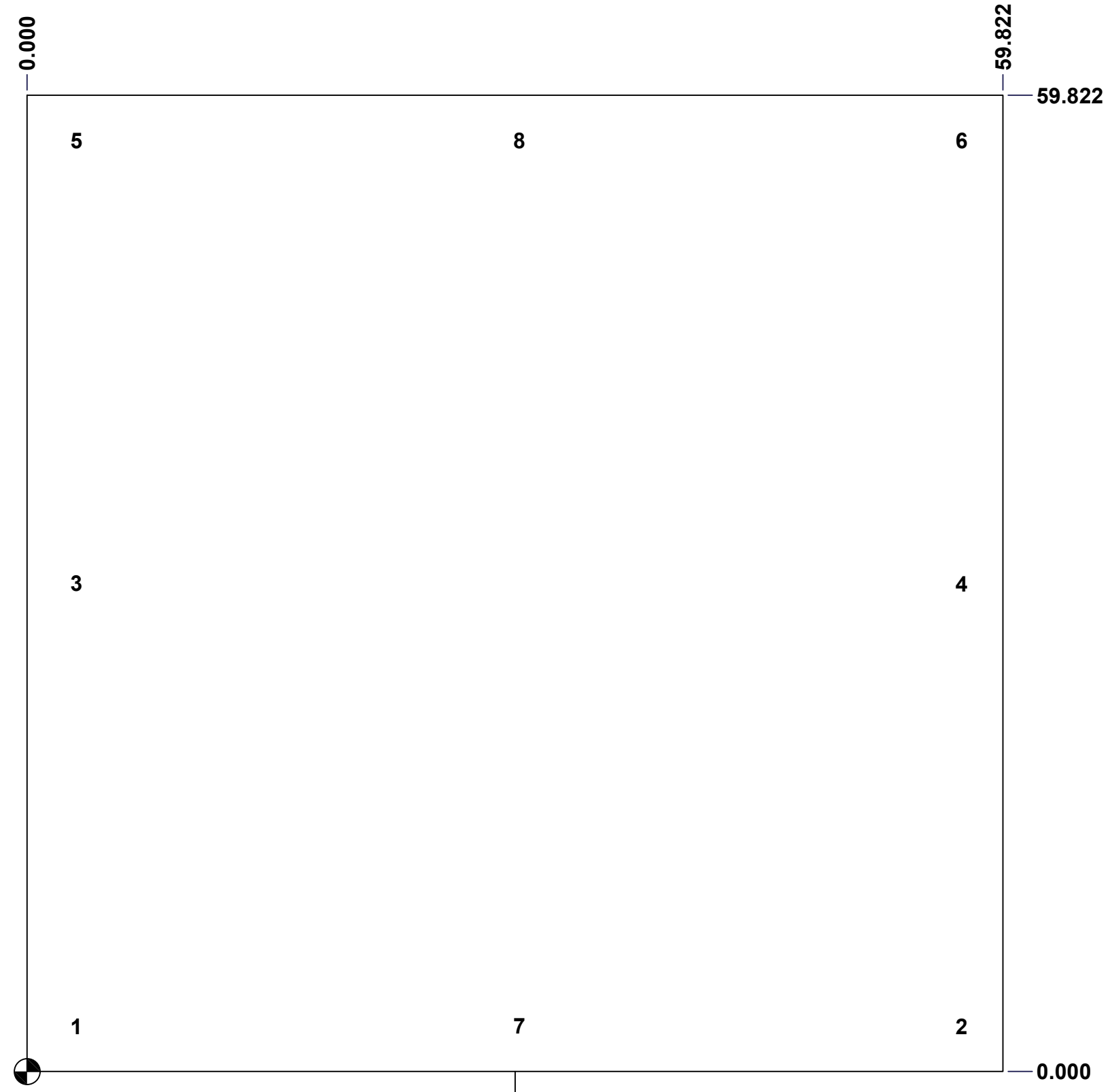

	Description	Status
	5500DDS 60" x 60" x 10" Body	(NULL)
	Part Number Numéro Pièce	Rev.
	<b>5500DDS606010B</b>	<b>0</b> / 8
		17



This drawing is confidential and must not be reproduced or used without the consent of EXM

Ce dessin est confidentiel et ne doit pas être reproduit ou utilisé sans le consentement de EXM

No.	Revisions	Date	By/Par

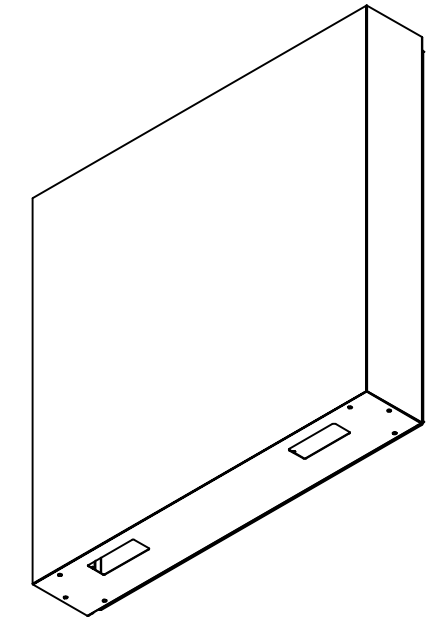

Isometric View



4	STK-Q-16030	0	Stud M6 x 10mm Steel
2	STK-Q-74930	0	Eyebolt Lifting Angle (6.750")
1	STK-P-02400S	0	Powder Paint (Asa-61 Grey / Smooth)
2	STK-Q-07320	0	Flange Lock Nut M10
2	STK-Q-07618	1	5500 Series Inner Panel Support Bracket
8	STK-Q-16100	0	Stud M10 x 40mm Steel
1	5500DDS606010BT-P	0	5500DDS 60" x 10" Bottom Part
1	5500DDS606010T-P	0	5500DDS 60" x 10" Top Part
1	5500DDS606010RS-P	0	5500DDS 60" x 60" Right Part
1	5500DDS606010LS-P	0	5500DDS 60" x 60" Left Part
1	5500DDS606010B-P	0	5500DDS 60" x 60" Back Part
2	5500DDS606010_CR400 MS_21.5	0	Commercial Roll Mild Steel (21.5in long)
6	STK-Q-16080	0	Ground Stud M6 x 16mm Steel

Qty	Part Number	Rev	Description
Parts List			

	Tél: (450) 979-4373 Fax: (450) 979-4626 <a href="http://www.exmweb.com">www.exmweb.com</a>	Flatness Aplatissement Max 3.0mm
	Projection 	Customer Client
Drawn By Dessiné Par BoxCad: BoxCad	Date 09-Sep-14	Detail Rev.
Material Matière 12 Ga Cold Rolled A1008 CS Type B (2.5mm)	Color Couleur Asa-61 Grey	Finish Fini Smooth
Description 5500DDS 60" x 60" x 10" Body		Rev. 9 0
Part Number Numéro Pièce <b>5500DDS606010B</b>		17

This drawing is confidential and must not be reproduced or used without the consent of EXM

Ce dessin est confidentiel et ne doit pas être reproduit ou utilisé sans le consentement de EXM

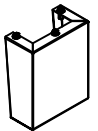
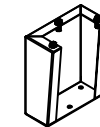
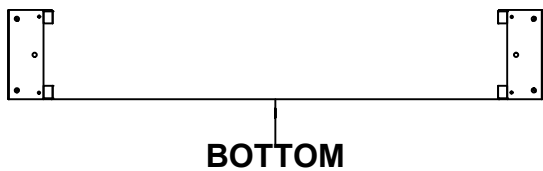
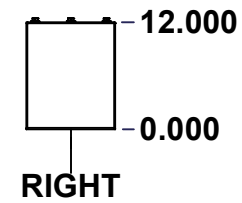
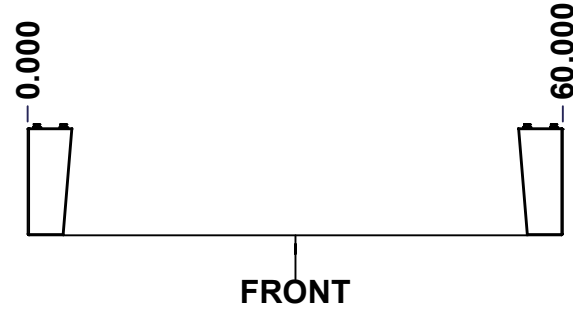
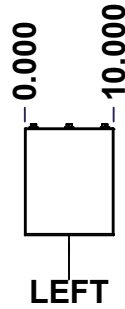
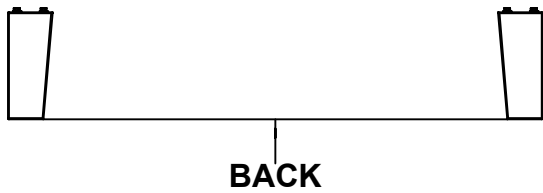
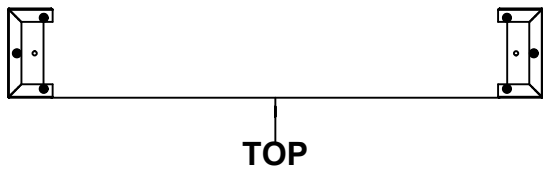

**Isometric View**



No.	Revisions	Date	By/Par

 Tél: (450) 979-4373 Fax: (450) 979-4626 <a href="http://www.exmweb.com">www.exmweb.com</a>		Flatness Aplatissement
		Max 3.0mm
Customer Client		Date
Drawn By Dessiné Par BoxCad: BoxCad		Date 09-Sep-14
Material Matière 12 Ga Cold Rolled A1008 CS Type B (2.5mm)		
Color Couleur	Asa-61 Grey	Finish Fini Smooth
Description 885 MFHD 12" x 10" Mounting Feet		Detail Rev.
Part Number Numéro Pièce <b>5500DDS606010MF</b>		Rev. 10 <b>0</b>

**SEE BILL OF MATERIAL ON LAST PAGE**

This drawing is confidential and must not be reproduced or used without the consent of EXM

Ce dessin est confidentiel et ne doit pas être reproduit ou utilisé sans le consentement de EXM

No.	Revisions	Date	By/Par

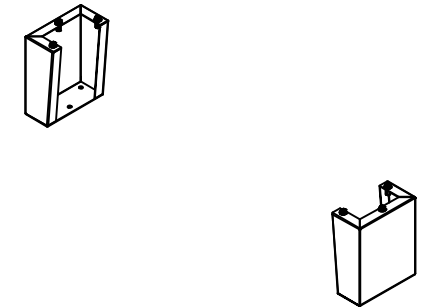

Isometric View



Tél: (450) 979-4373  
 Fax: (450) 979-4626  
[www.exmweb.com](http://www.exmweb.com)

Flatness  
Aplatissement  
Max 3.0mm  
Projection

Customer Client	Date
Drawn By / Dessiné Par: BoxCad: BoxCad	Date: 09-Sep-14
Material / Matière: 12 Ga Cold Rolled A1008 CS Type B (2.5mm)	

Color / Couleur: Asa-61 Grey	Finish / Fini: Smooth
------------------------------	-----------------------

Description: 885 MFHD 12" x 10" Mounting Feet	Detail Rev.
---	-------------

Part Number / Numéro Pièce: <b>5500DDS606010MF</b>	Rev. 0	11 / 17
--	--------	---------

Qty	Part Name	Rev	Description
1	STK-P-02400S	0	Powder Paint (Asa-61 Grey / Smooth)
6	RIVET_NUT_M10_FH_CE	0	Rivet Nut M10 (Low Profile Close End)
1	5500DDS606010MFR-P	0	885 MFHD 12" x 10" Right Mounting Feet Part
1	5500DDS606010MFL-P	0	885 MFHD 12" x 10" Left Mounting Feet Part
3	STK-K-11600	2	885 MF Accessory Kit
Parts List			

This drawing is confidential and must not be reproduced or used without the consent of EXM

Ce dessin est confidentiel et ne doit pas être reproduit ou utilisé sans le consentement de EXM

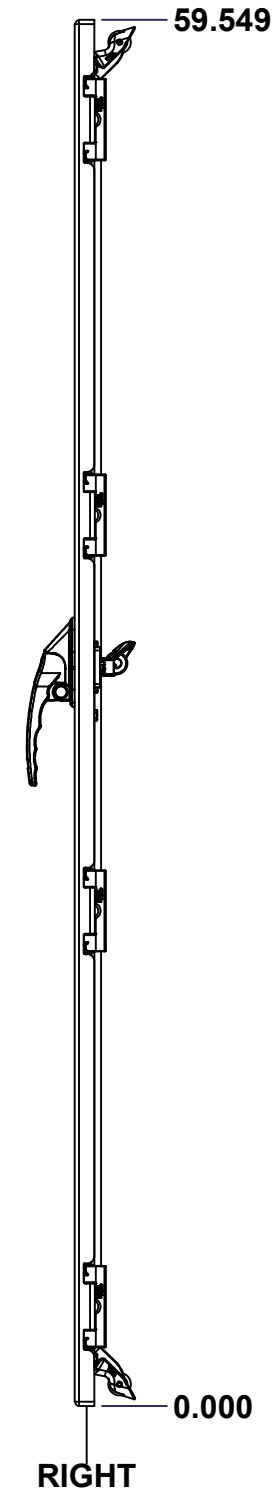
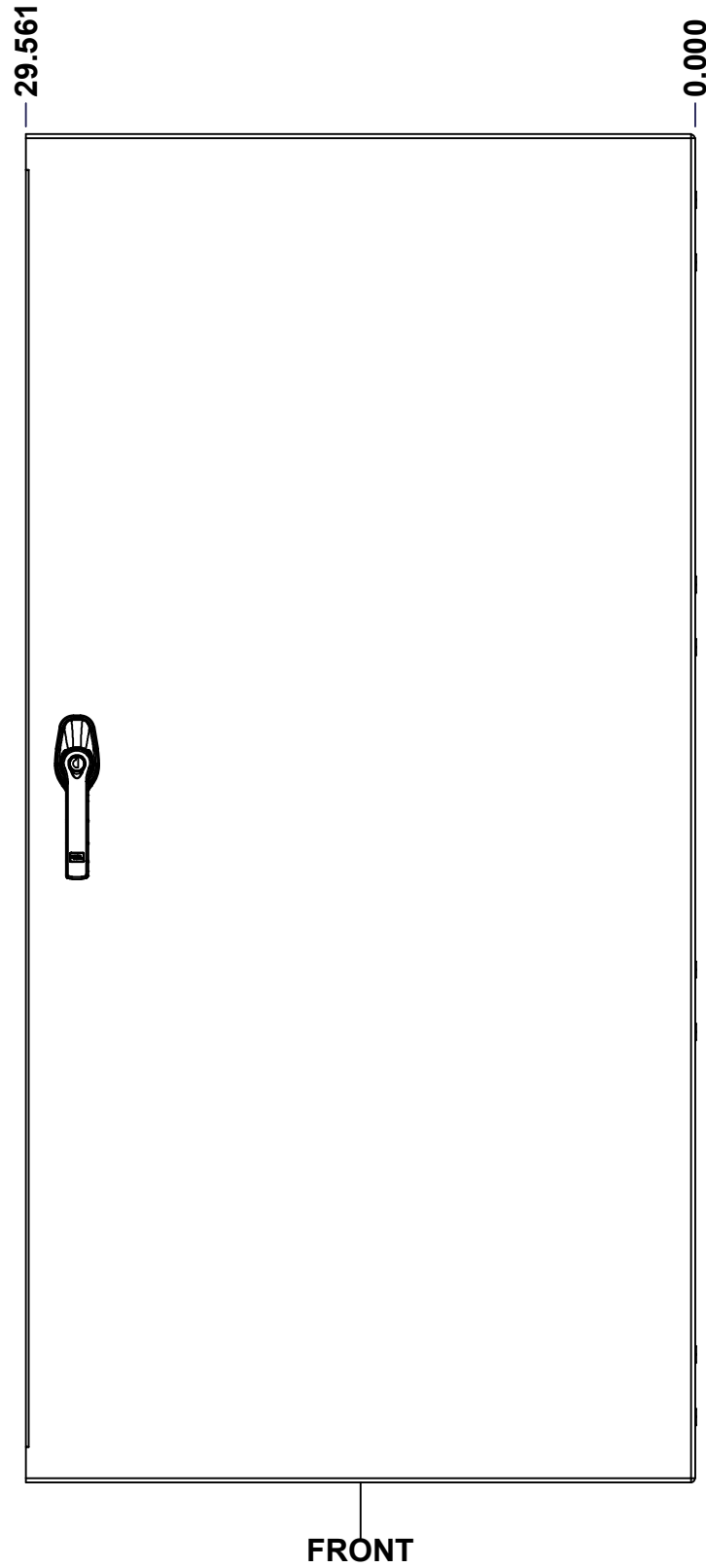
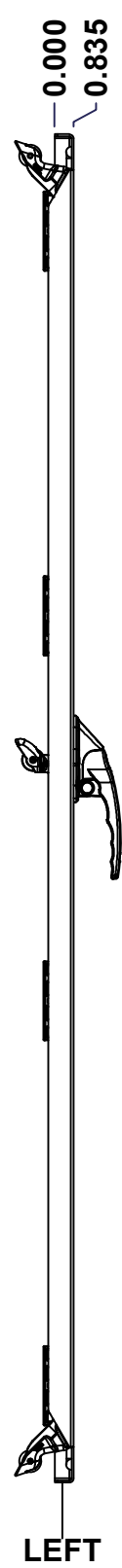
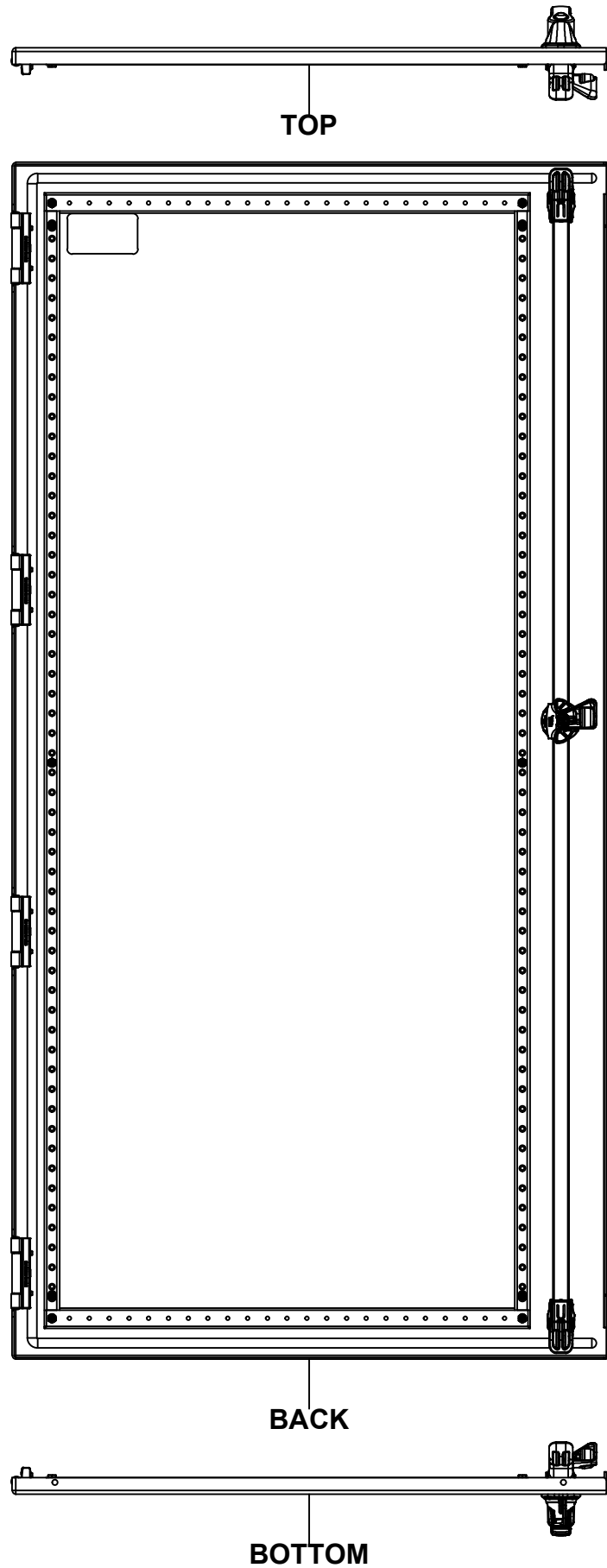

No.	Revisions	Date	By/Par

**Isometric View**

Tél: (450) 979-4373 Fax: (450) 979-4626 <a href="http://www.exmweb.com">www.exmweb.com</a>		Flatness Aplatissement
		Max 3.0mm
Customer Client		Date
Drawn By Dessiné Par BoxCad: BoxCad		Date 09-Sep-14
Material Matière 12 Ga Cold Rolled A1008 CS Type B (2.5mm)		
Color Couleur	Asa-61 Grey	Finish Fini Smooth
Description 5500DDS 60" x 60" Cover		Detail Rev.
Part Number Numéro Pièce <b>5500DDS606010LD</b>		Rev. 12 <b>0</b>

SEE BILL OF MATERIAL ON LAST PAGE

This drawing is confidential and must not be reproduced or used without the consent of EXM

Ce dessin est confidentiel et ne doit pas être reproduit ou utilisé sans le consentement de EXM

**STANDARD FEATURES ARE NOT LISTED IN THIS HOLE TABLE**

**HOLE TABLE - FRONT VIEW (CUSTOM FEATURE ONLY)**

CUT-OUT	XDIM	YDIM	DESCRIPTION
1	1.983	2.028	STUD M6 x 18mm (Inside)
2	1.983	29.675	STUD M6 x 18mm (Inside)
3	1.983	57.521	STUD M6 x 18mm (Inside)
4	1.983	3.139	STUD M6 x 18mm (Inside)
5	1.983	56.409	STUD M6 x 18mm (Inside)
6	25.390	2.028	STUD M6 x 18mm (Inside)
7	25.390	29.675	STUD M6 x 18mm (Inside)
8	25.390	57.521	STUD M6 x 18mm (Inside)
9	25.390	3.139	STUD M6 x 18mm (Inside)
10	25.390	56.409	STUD M6 x 18mm (Inside)
11	27.311	6.118	LARGE CBAR GUIDE (Inside)
12	27.311	53.430	LARGE CBAR GUIDE (Inside)
-----	-----	-----	-----
13	27.311	31.743	HANDLE 885 ESL2A-APHK @ 0.0°

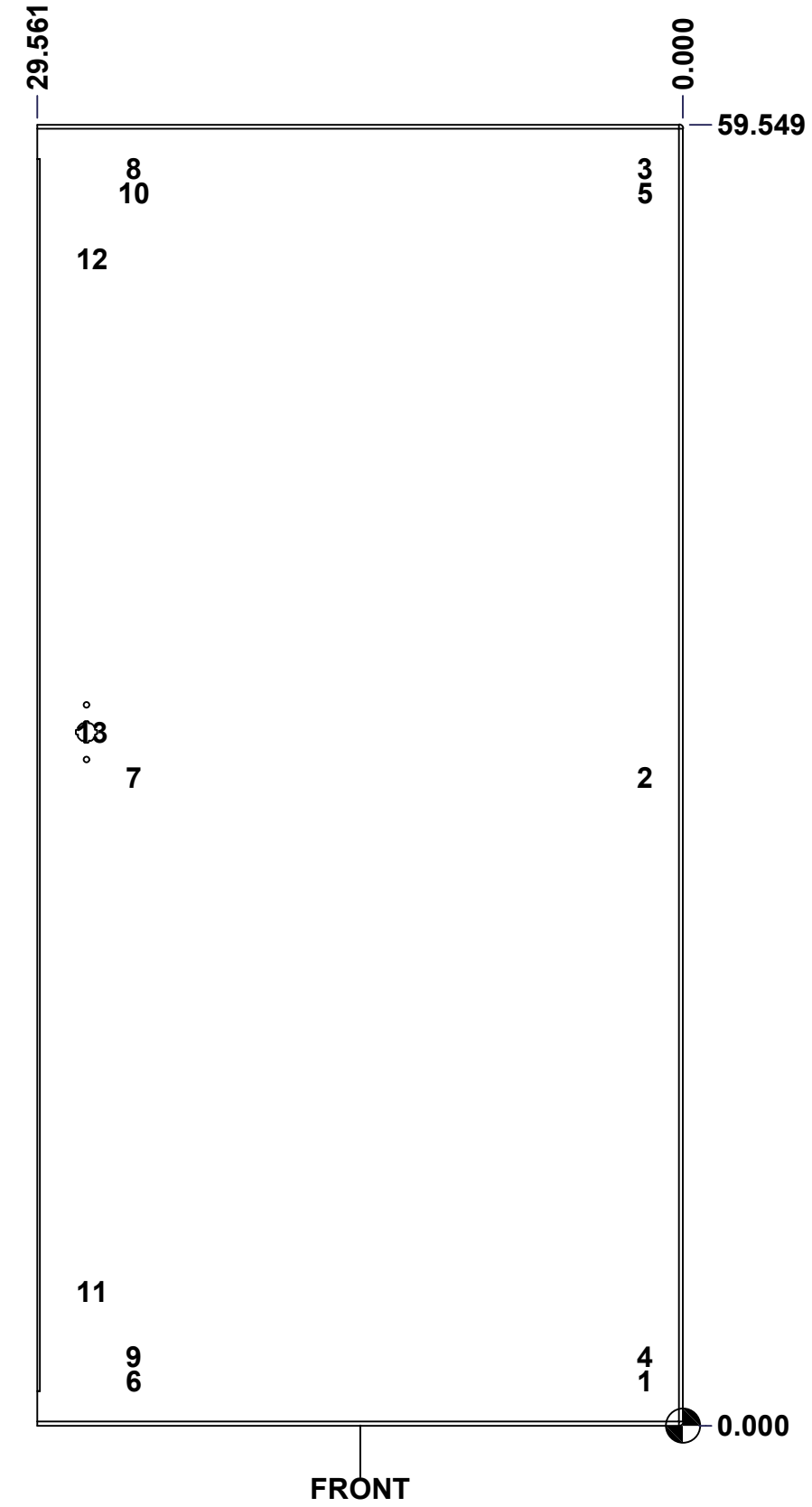

FRONT

	Description	Status
	5500DDS 60" x 60" Cover	(NULL)
	Part Number Numéro Pièce	Rev.
	<b>5500DDS606010LD</b>	<b>0</b>
		13
		17

This drawing is confidential and must not be reproduced or used without the consent of EXM

Ce dessin est confidentiel et ne doit pas être reproduit ou utilisé sans le consentement de EXM

No.	Revisions	Date	By/Par

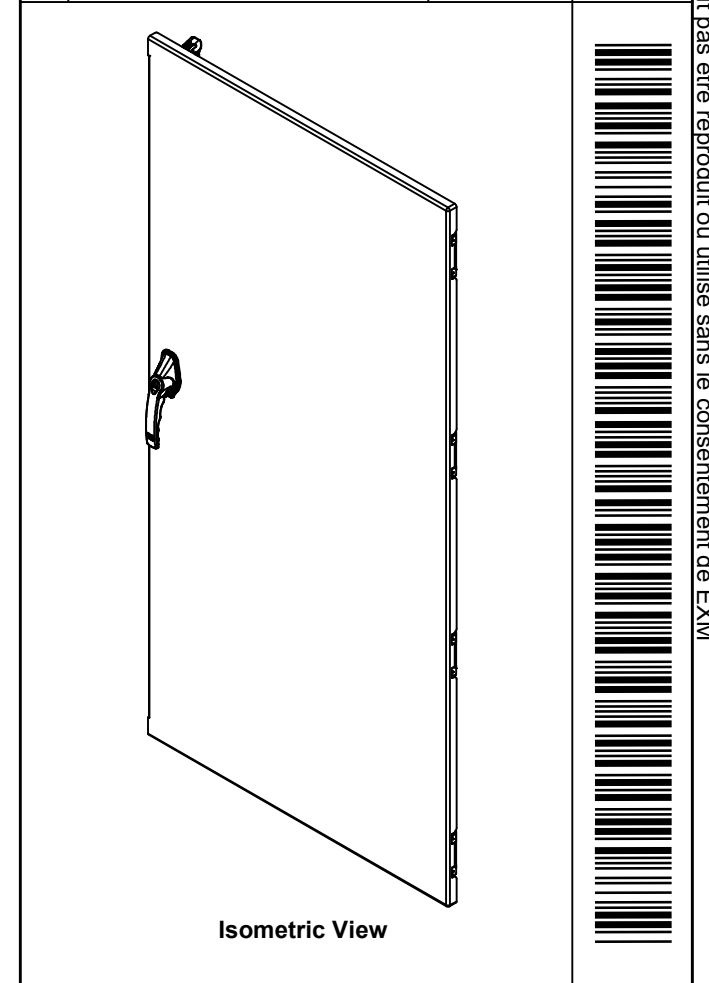

1	STK-Q-47541	1	5500 DDS Lower Closing Bar 60"
1	STK-Q-47531	0	5500 DDS Upper Closing Bar 60"
1	STK-A-50537	3	9500 Handle Cam Assembly (Left Side, Grip 36mm)
1	STK-Q-90051	3	5412 ES - Handle Cam Spacer
1	885ESL2A-APHK	7	885 ESL2A-APHK - Zinc Die Cast L-Handle Padlockable Assy
1	STK-P-02400S	0	Powder Paint (Asa-61 Grey / Smooth)
1	STK-S-00100	0	3.5" x 2" Silver Milar Flexcon Sticker
1	STK-K-10710	3	5500 DDS - Door Stiffener Assembly
2	STK-Q-16410	0	Guide Stud - Largel (No Paint Cap Required)
10	STK-Q-16055	1	M6 x 18mm Stud (No Paint Cap Required)
1	5500DDS606010LDG	0	5500DDS 60" x 60" Lock Door Gasket
1	5500DDS606010LD-P	0	5500DDS 60" x 60" Lock Door Part
2	STK-A-90025	0	9500 - Cabinet Closing Bar End (Large)
4	STK-K-09860	7	Cabinet Hinge with Captive Pins
2	STK-Q-07220	1	M6 Nylon Insert Lock Nut

QTY	Part Number	Rev	Description
Parts List			

 Tél: (450) 979-4373 Fax: (450) 979-4626 <a href="http://www.exmweb.com">www.exmweb.com</a>		Flatness Aplatissement
		Max 3.0mm
Customer Client		Date
Drawn By Dessiné Par BoxCad: BoxCad		Date 09-Sep-14
Material Matière 12 Ga Cold Rolled A1008 CS Type B (2.5mm)		
Color Couleur Asa-61 Grey	Finish Fini Smooth	
Description 5500DDS 60" x 60" Cover		Detail Rev.
Part Number Numéro Pièce <b>5500DDS606010LD</b>		Rev. 0
		14 17

This drawing is confidential and must not be reproduced or used without the consent of EXM

Ce dessin est confidentiel et ne doit pas être reproduit ou utilisé sans le consentement de EXM

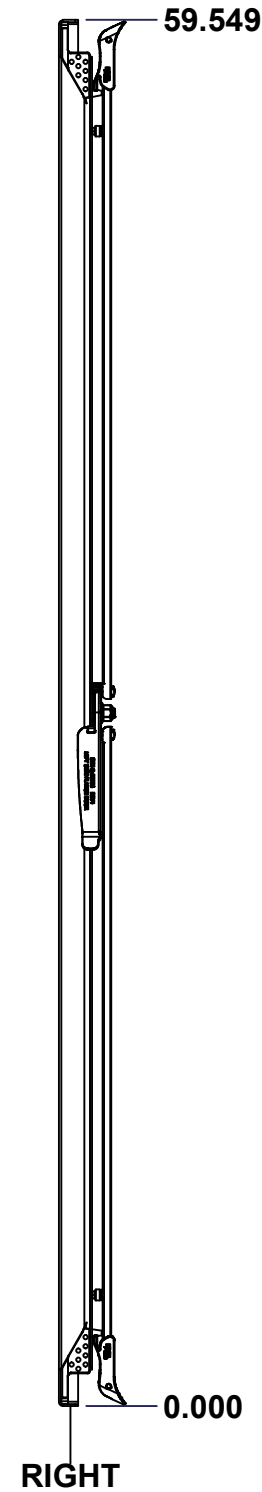
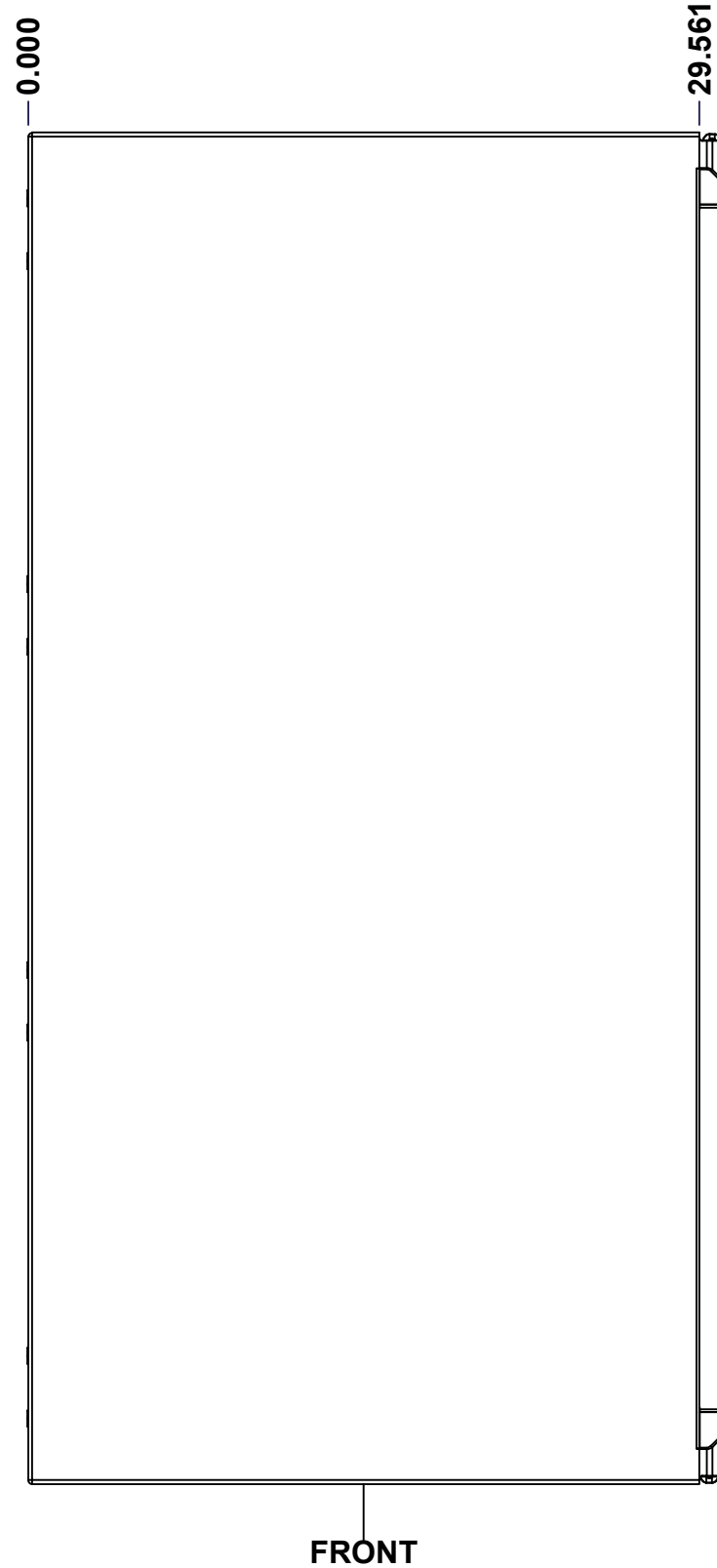
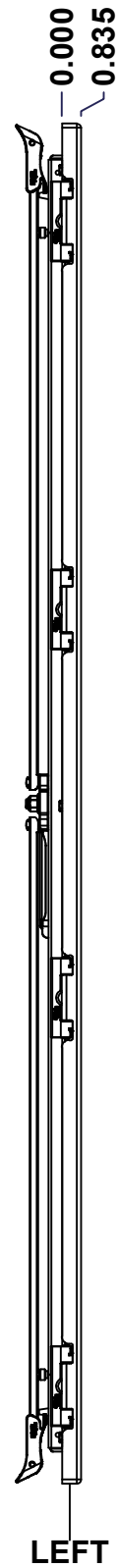
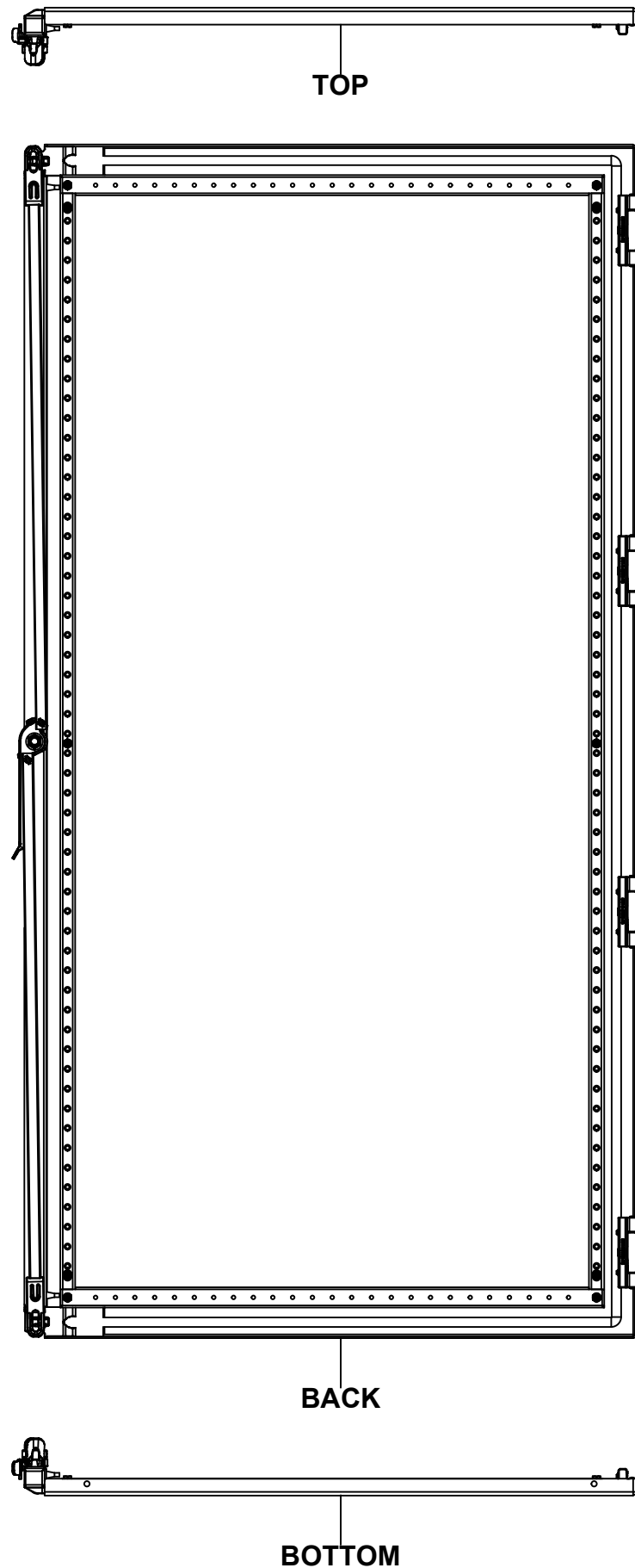

No.	Revisions	Date	By/Par

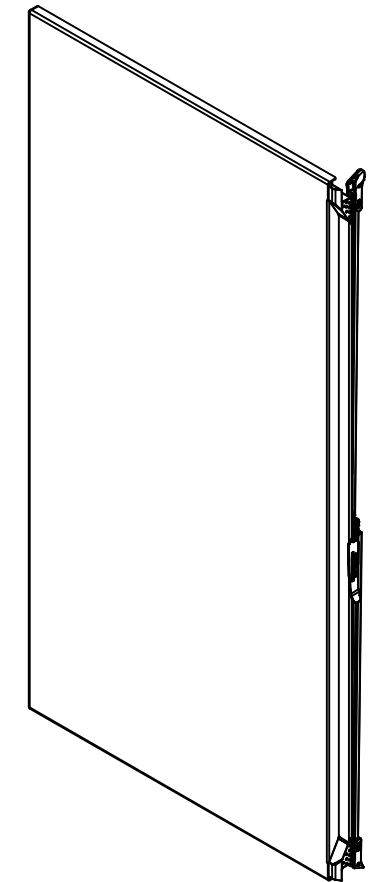

Isometric View



Tél: (450) 979-4373  
 Fax: (450) 979-4626  
[www.exmweb.com](http://www.exmweb.com)

Flatness  
Aplatissement

Max 3.0mm

Projection

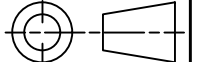

Customer Client	Date
Drawn By Dessiné Par BoxCad: BoxCad	Date 09-Sep-14
Material Matière 12 Ga Cold Rolled A1008 CS Type B (2.5mm)	
Color Couleur Asa-61 Grey	Finish Fini Smooth
Description 5500DDS 60" x 60" Cover	Detail Rev.
Part Number Numéro Pièce <b>5500DDS606010FD</b>	Rev. 15 <b>0</b> 17

SEE BILL OF MATERIAL ON LAST PAGE

This drawing is confidential and must not be reproduced or used without the consent of EXM

Ce dessin est confidentiel et ne doit pas être reproduit ou utilisé sans le consentement de EXM

**STANDARD FEATURES ARE NOT LISTED IN THIS HOLE TABLE**

**HOLE TABLE - FRONT VIEW (CUSTOM FEATURE ONLY)**

CUT-OUT	XDIM	YDIM	DESCRIPTION
1	2.000	2.028	STUD M6 x 18mm (Inside)
2	2.000	29.675	STUD M6 x 18mm (Inside)
3	2.000	57.521	STUD M6 x 18mm (Inside)
4	2.000	3.139	STUD M6 x 18mm (Inside)
5	2.000	56.409	STUD M6 x 18mm (Inside)
6	28.407	2.028	STUD M6 x 18mm (Inside)
7	28.407	29.675	STUD M6 x 18mm (Inside)
8	28.407	57.521	STUD M6 x 18mm (Inside)
9	28.407	3.139	STUD M6 x 18mm (Inside)
10	28.407	56.409	STUD M6 x 18mm (Inside)
11	30.061	4.774	SMALL CBAR GUIDE (Inside)
12	30.061	54.774	SMALL CBAR GUIDE (Inside)
13	30.061	29.774	STUD M10 x 25mm (Inside)

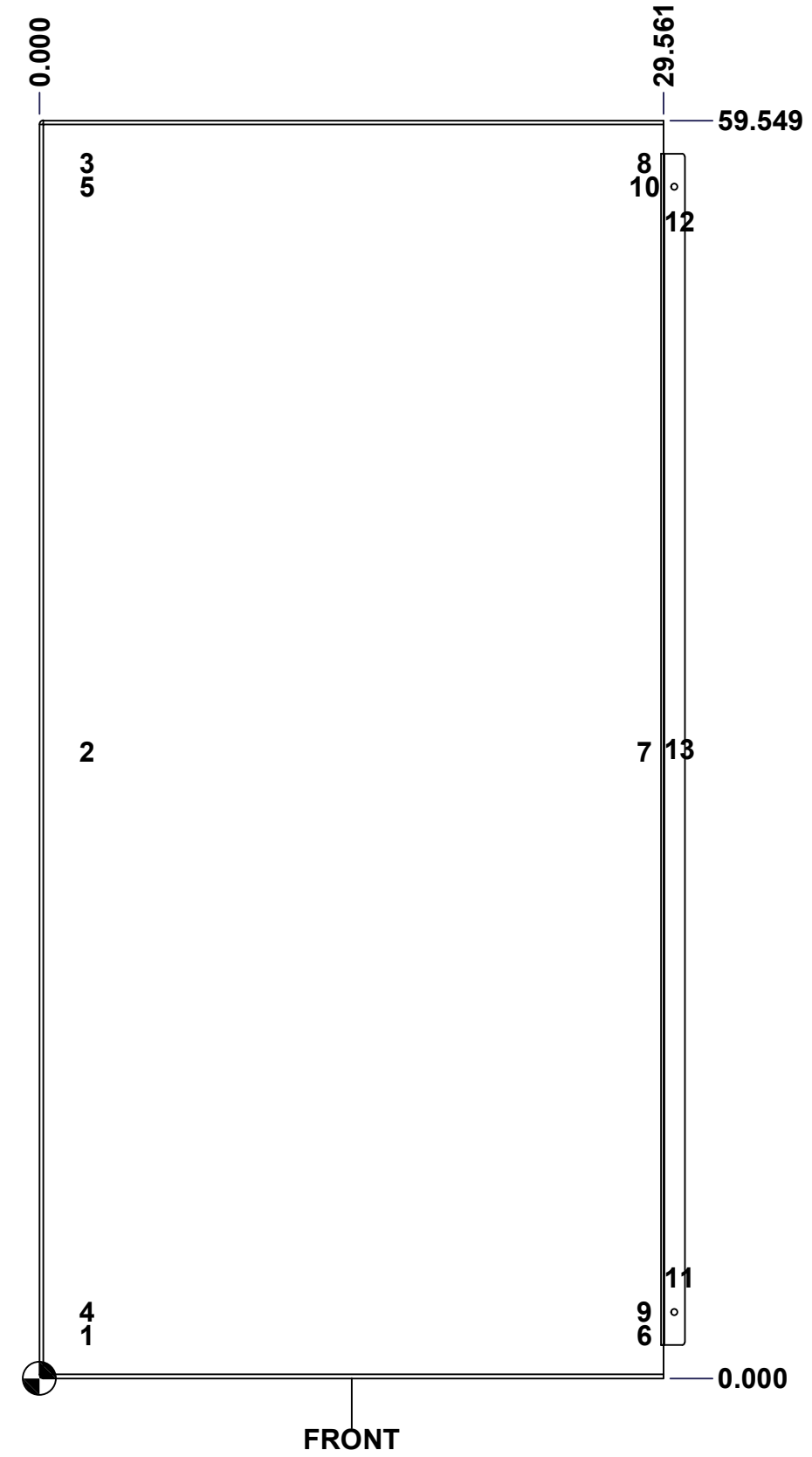

FRONT

	Description	Status	
	5500DDS 60" x 60" Cover	(NULL)	
	Part Number Numéro Pièce	Rev.	16
	5500DDS606010FD	0	17



This drawing is confidential and must not be reproduced or used without the consent of EXM

Ce dessin est confidentiel et ne doit pas être reproduit ou utilisé sans le consentement de EXM

No.	Revisions	Date	By/Par

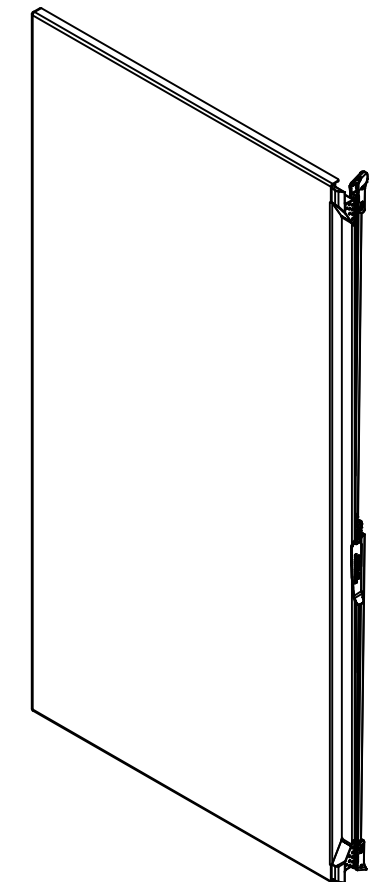

Isometric View



1	STK-G-03400	1	5500 DD Lower Flange Door Gasket
1	STK-G-03300	2	5500 DD Upper Flange Door Gasket
2	STK-Q-90045	1	5500 DDS Flange Door Closing Bar End Assembly
2	STK-Q-45670-60	2	5500 DDS - Flange Door Closing Bar
1	STK-Q-07440	0	M10 Nylon Insert Flanged Lock Nut
1	STK-Q-50568	1	Flange Door Handle Spacer
1	STK-A-50556	4	Left Side Flange Door Handle Assembly
1	STK-K-20710	4	5500 DDS - Flange Door Stiffener Assembly
1	STK-Q-15005	0	Stud M10 x 25mm
2	STK-Q-16405	7	Guide Stud - Small (No Paint Cap Required)
10	STK-Q-16055	1	M6 x 18mm Stud (No Paint Cap Required)
1	STK-G-00701	0	1" x 1/4" Self-Adhesive Neoprene Gasket
1	5500DDS606010FDG	0	5500DDS 60" x 60" Flange Door Gasket
1	5500DDS606010FD-P	0	5500DDS 60" x 60" Flange Door Part
4	STK-K-09860	7	Cabinet Hinge with Captive Pins

QTY	Part Number	Rev	Description
Parts List			

Tél: (450) 979-4373 Fax: (450) 979-4626 <a href="http://www.exmweb.com">www.exmweb.com</a>	Flatness Aplatissement	Max 3.0mm
	Projection	
Customer Client	Date	
Drawn By Dessiné Par	BoxCad: BoxCad	Date 09-Sep-14
Material Matière	12 Ga Cold Rolled A1008 CS Type B (2.5mm)	
Color Couleur	Asa-61 Grey	Finish Fini Smooth
Description	Detail Rev.	
5500DDS 60" x 60" Cover		
Part Number Numéro Pièce	Rev.	17
<b>5500DDS606010FD</b>	<b>0</b>	17

This drawing is confidential and must not be reproduced or used without the consent of EXM

Ce dessin est confidentiel et ne doit pas être reproduit ou utilisé sans le consentement de EXM

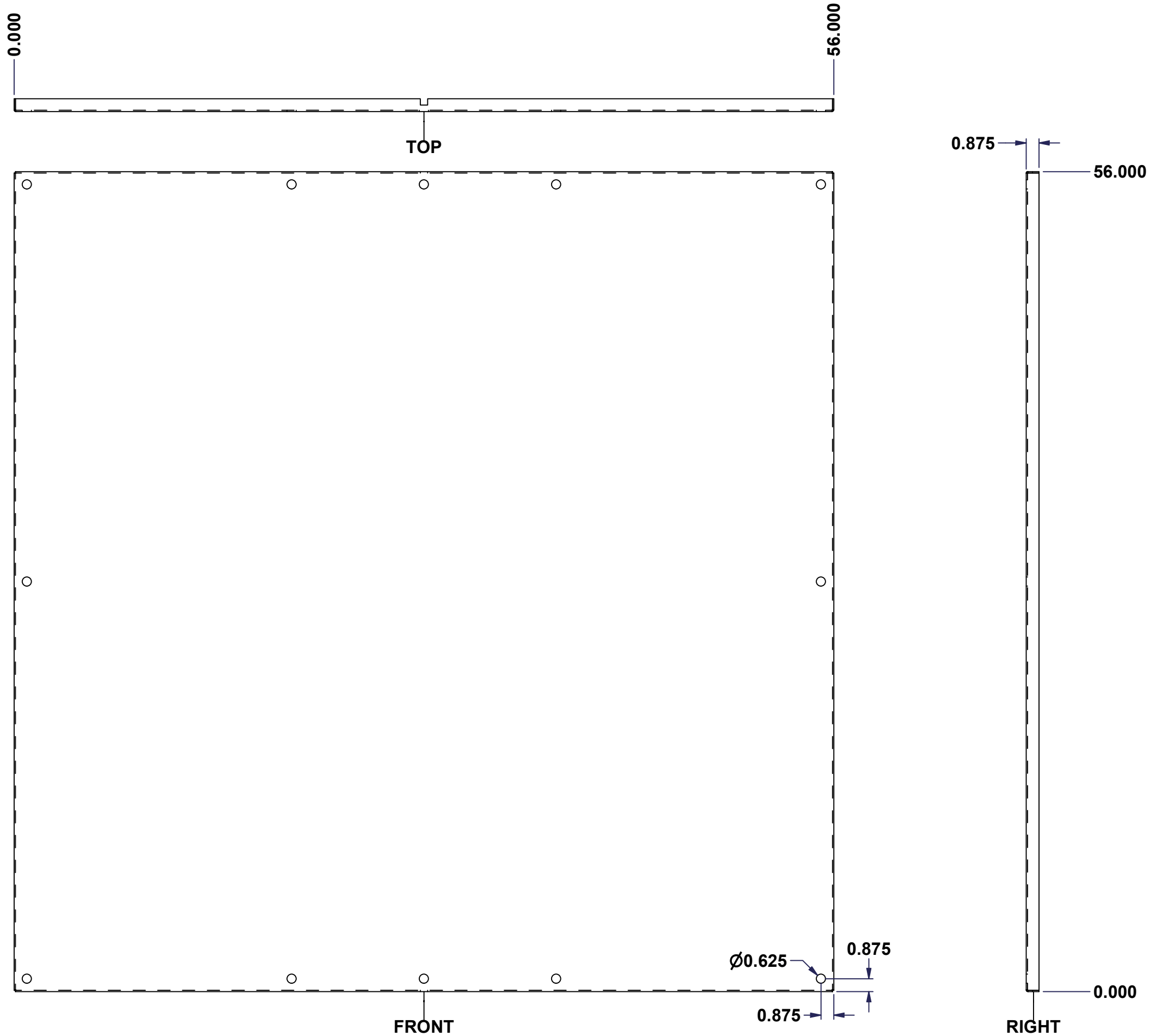

SEE BILL OF MATERIAL ON LAST PAGE

No.	Revisions	Date	By/Par

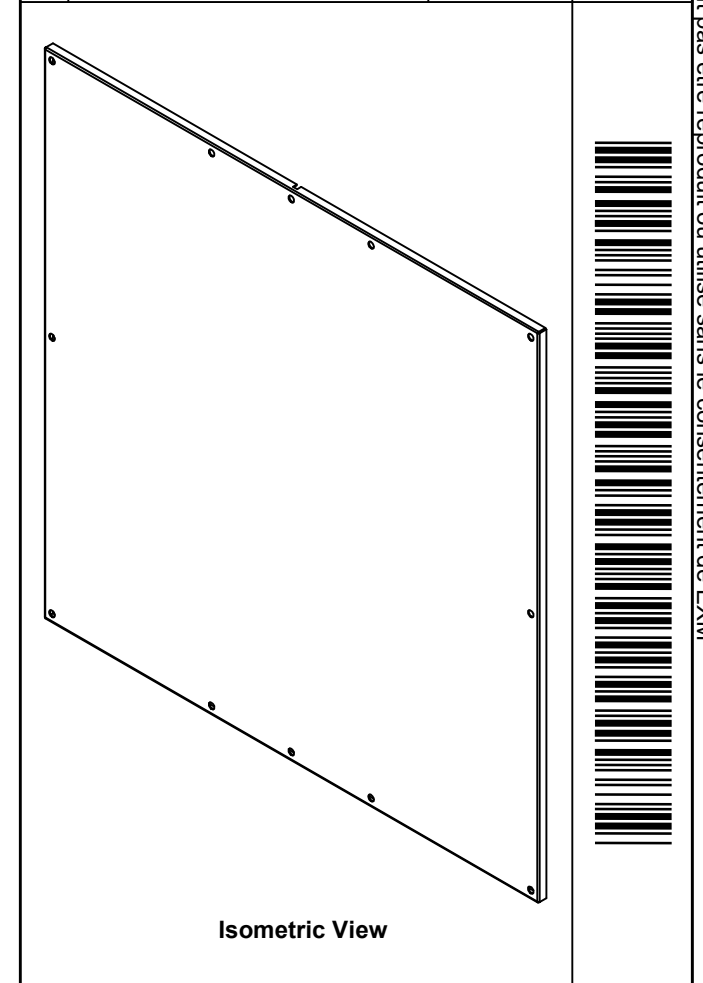



<p>Tél: (450) 979-4373 Fax: (450) 979-4626 www.exmweb.com</p>	Flatness Aplatissement Max 3.0mm
	Projection 
Customer Client	Date
Drawn By Dessiné Par BoxCad	Date 04/11/2009
Material Matière 12 Ga Galvanized (2.5mm)	
Color Couleur Unpainted	Finish Fini Unpainted
Description 885 SP6060G Inner Panel	
Detail Rev.	
Part Number Numéro Pièce <b>885SP6060G</b>	Rev. 1 2

This drawing is confidential and must not be reproduced or used without the consent of EXM

Ce dessin est confidentiel et ne doit pas être reproduit ou utilisé sans le consentement de EXM

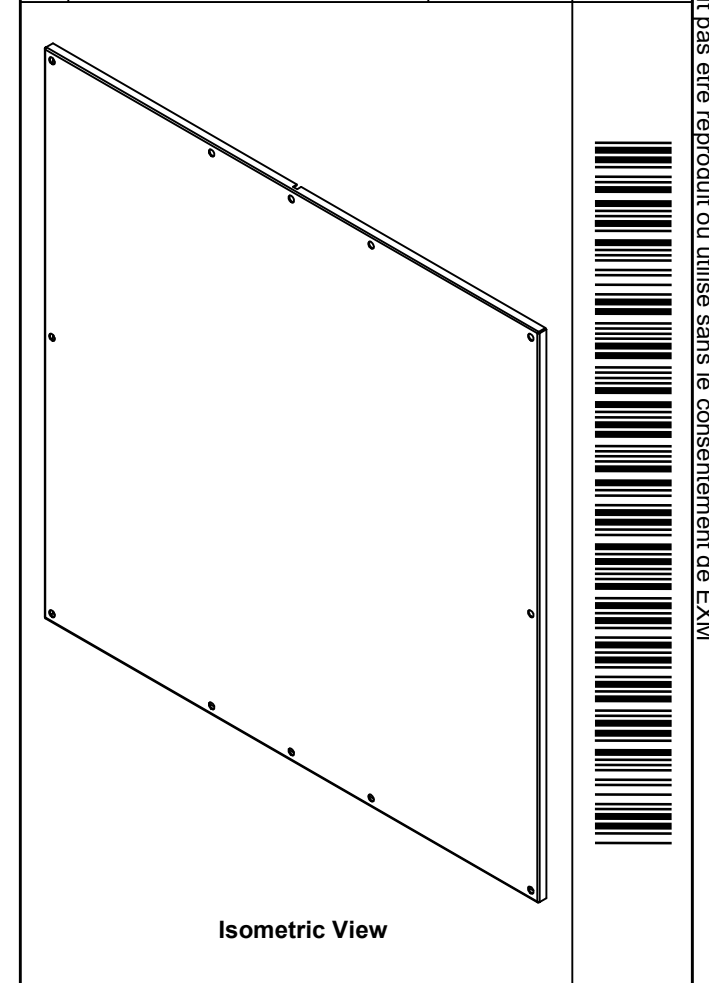
No.	Revisions	Date	By/Par

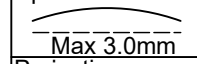

 Tél: (450) 979-4373 Fax: (450) 979-4626 www.exmweb.com		Flatness Aplatissement  Max 3.0mm
Customer Client		Date
Drawn By Dessiné Par BoxCad		Date 04/11/2009
Material Matière 12 Ga Galvanized (2.5mm)		
Color Couleur Unpainted	Finish Fini Unpainted	
Description 885 SP6060G Inner Panel		Detail Rev.
Part Number Numéro Pièce <b>885SP6060G</b>		Rev. <b>0</b> / 2

Qty	Part Number	Rev	Description
1	885SP6060G-P	0	885 SP6060G Inner Panel Part
Parts List			