

This drawing is confidential and must not be reproduced or used without the consent of EXM

Ce dessin est confidentiel et ne doit pas être reproduit ou utilisé sans le consentement de EXM

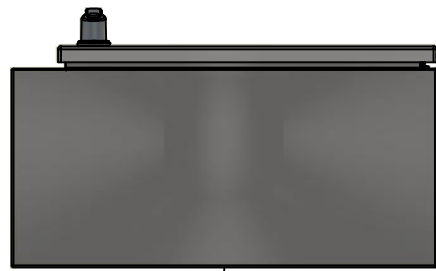

TOP

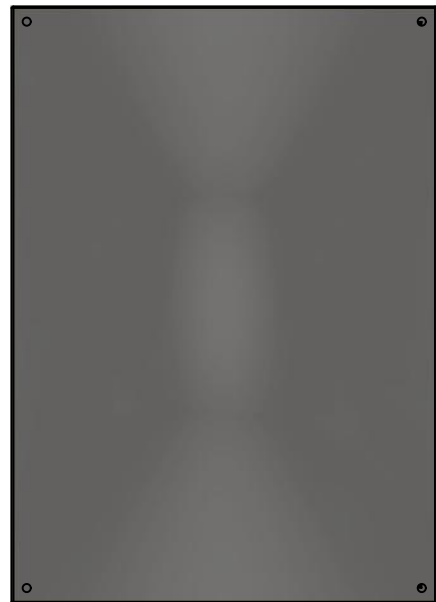

BACK



LEFT



FRONT



RIGHT

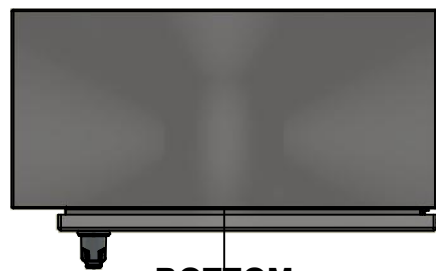

BOTTOM

| No. | Revisions | Date | By/Par |
|-----|-----------|------|--------|
|     |           |      |        |
|     |           |      |        |
|     |           |      |        |
|     |           |      |        |



Isometric View



Tél: (450) 979-4373  
 Fax: (450) 979-4626  
[www.exmweb.com](http://www.exmweb.com)

Flatness  
Aplatissement

Max 3.0mm

Projection

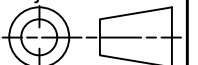

|   |                        |
|---|------------------------|
| Customer Client                                       | Date                   |
| Drawn By<br>Dessiné Par BoxCad: BoxCad                | Date 2014-10-27        |
| Material<br>Matière 16 Ga Stainless Steel 304 (1.4mm) |                        |
| Color<br>Couleur Unpainted                            | Finish<br>Fini Brushed |
| Description<br>5500ESSY 30" x 21.375" x 10" Assembly  | Detail Rev.            |
| Part Number<br>Numéro Pièce 5500ESSY302110            | Rev. 0                 |

SEE BILL OF MATERIAL ON LAST PAGE

This drawing is confidential and must not be reproduced or used without the consent of EXM

Ce dessin est confidentiel et ne doit pas être reproduit ou utilisé sans le consentement de EXM

| NOTE |  |
|------|--|
| ITEM | DESCRIPTION                                |
| 1    | NEMA 12/13 Enclosure                       |
| 2    | C/W Standard ground studs on box and cover |
| 3    | C/W Standard door stiffener                |
| 4    | C/W Standard inner panel (Included)        |
| 5    | C/W Standard inner panel mounting studs    |
| 6    | C/W 880 PP included (Not installed)        |

| No. | Revisions | Date | By/Par |
|-----|-----------|------|--------|
|     |           |      |        |
|     |           |      |        |
|     |           |      |        |
|     |           |      |        |
|     |           |      |        |
|     |           |      |        |



Isometric View



Tél: (450) 979-4373  
 Fax: (450) 979-4626  
[www.exmweb.com](http://www.exmweb.com)



| PACKING               |     |  |
|-----------------------|-----|--|
| ITEM                  | QTY | DESCRIPTION                                |
| Cardboard sleeve      | 2   | Top and Bottom                             |
| Cardboard strip       | 2   | Between back of enclosure and inner panel  |
| Plastic bag           | 1   | To protect cover surface and inside gasket |
| Plastic strap - Black | 2   | To Squeeze the 2 cardboard sleeve together |
| Packaging label       | 1   | White label with product number            |

|            |                 |     |  |
|------------|-----------------|-----|--|
| 1          | STK-K-01800     | 5   | 5412 ES Accessory Kit  |
| 1          | 880 PP          | 6   | Self Adhesive Print Pocket   |
| 1          | 5500ESSY302110C | 0   | 5500ESSY 30" x 21.375" Cover   |
| 4          | STK-Q-07310     | 2   | Flange Lock Nut M8   |
| 1          | 881 SP3020G     | 0   | 881 SP - Inner Panel   |
| 4          | STK-Q-07610     | 8   | M8 Plastic Spacer 22.2mm   |
| 1          | 5500ESSY302110B | 0   | 5500ESSY 30" x 21.375" x 10" Body                                      |
| 2          | STK-Q-04051-07  | 8   | M6 x 7mm Stainless Steel Hexagon Socket Head Machine Screw with Nyseal |
| Qty        | Part Number     | Rev | Description  |
| Parts List |                 |     |  |

|                                       |                                   |
|---------------------------------------|-----------------------------------|
| Customer Client                       | Date                              |
| Drawn By<br>Dessiné Par               | Date 2014-10-27                   |
| Material<br>Matière                   | 16 Ga Stainless Steel 304 (1.4mm) |
| Color<br>Couleur                      | Unpainted                         |
| Finish<br>Fini                        | Brushed                           |
| Description                           | Detail Rev.                       |
| 5500ESSY 30" x 21.375" x 10" Assembly |                                   |
| Part Number<br>Numéro Pièce           | Rev.                              |
| <b>5500ESSY302110</b>                 | <b>0</b>                          |
|                                       | 2                                 |
|                                       | 9                                 |

This drawing is confidential and must not be reproduced or used without the consent of EXM

Ce dessin est confidentiel et ne doit pas être reproduit ou utilisé sans le consentement de EXM

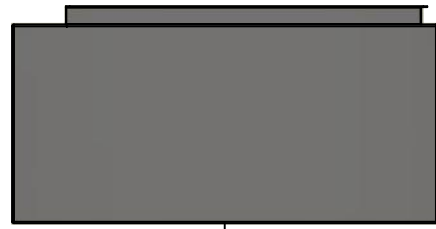

TOP

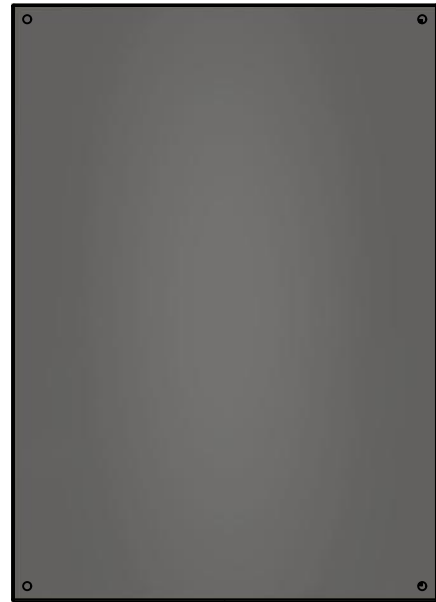

BACK

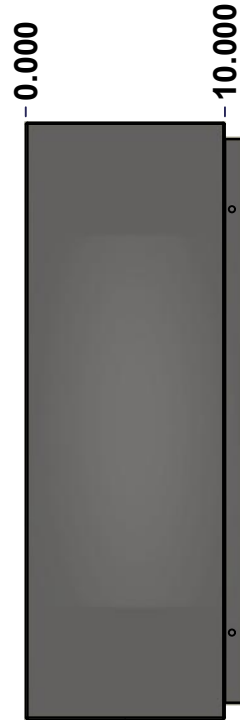

LEFT

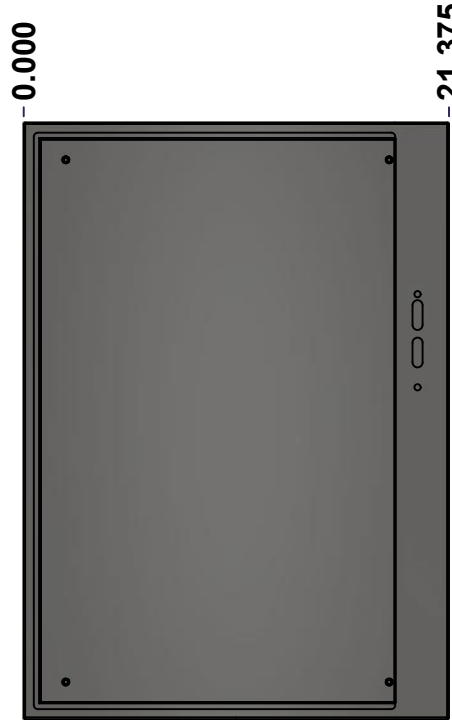

FRONT



RIGHT

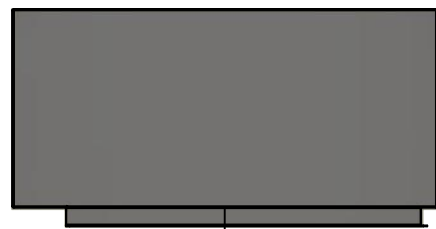

BOTTOM

| No. | Revisions | Date | By/Par |
|-----|-----------|------|--------|
|     |           |      |        |
|     |           |      |        |
|     |           |      |        |
|     |           |      |        |



Isometric View



Tél: (450) 979-4373  
 Fax: (450) 979-4626  
[www.exmweb.com](http://www.exmweb.com)

Flatness  
Aplatissement

Max 3.0mm

Projection

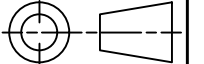

|   |                        |
|---|------------------------|
| Customer Client                                       | Date                   |
| Drawn By<br>Dessiné Par BoxCad: BoxCad                | Date 2014-10-27        |
| Material<br>Matière 16 Ga Stainless Steel 304 (1.4mm) |                        |
| Color<br>Couleur Unpainted                            | Finish<br>Fini Brushed |
| Description<br>5500ESSY 30" x 21.375" x 10" Body      | Detail Rev.            |
| Part Number<br>Numéro Pièce <b>5500ESSY302110B</b>    | Rev. 3<br><b>0</b>     |

SEE BILL OF MATERIAL ON LAST PAGE

This drawing is confidential and must not be reproduced or used without the consent of EXM

Ce dessin est confidentiel et ne doit pas être reproduit ou utilisé sans le consentement de EXM

| <b>STANDARD FEATURES ARE NOT LISTED IN THIS HOLE TABLE</b> |       |       |                             |
|--|-------|-------|-----------------------------|
| <b>HOLE TABLE - LEFT VIEW (CUSTOM FEATURE ONLY)</b>        |       |       |                             |
| CUT-OUT  | XDIM  | YDIM  | DESCRIPTION                 |
| 1  | 8.500 | 2.000 | GND STUD M6 x 16mm (Inside) |

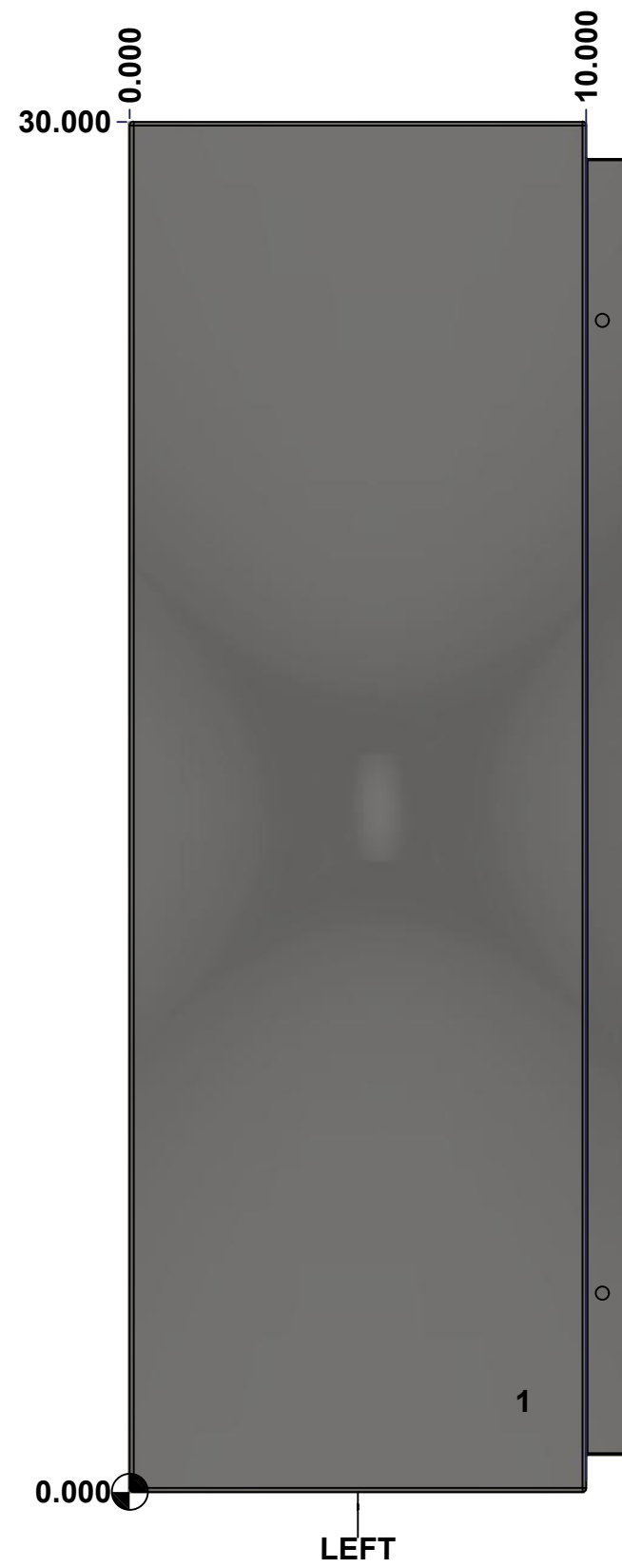

|  |                                   |          |     |
|--|-----------------------------------|----------|-----|
|  | Description                       | Status   |     |
|  | 5500ESSY 30" x 21.375" x 10" Body | (NULL)   |     |
|  | Part Number<br>Numéro Pièce       | Rev.     |     |
|  | <b>5500ESSY302110B</b>            | <b>0</b> | 4/9 |

This drawing is confidential and must not be reproduced or used without the consent of EXM

Ce dessin est confidentiel et ne doit pas être reproduit ou utilisé sans le consentement de EXM

**STANDARD FEATURES ARE NOT LISTED IN THIS HOLE TABLE**

**HOLE TABLE - BACK VIEW (CUSTOM FEATURE ONLY)**

| CUT-OUT | XDIM   | YDIM   | DESCRIPTION                |
|---------|--------|--------|----------------------------|
| 1       | 3.000  | 1.875  | IP STUD M8 x 35mm (Inside) |
| 2       | 3.000  | 28.125 | IP STUD M8 x 35mm (Inside) |
| 3       | 19.250 | 28.125 | IP STUD M8 x 35mm (Inside) |
| 4       | 19.250 | 1.875  | IP STUD M8 x 35mm (Inside) |
| -----   |        |        |                            |
| 5       | 20.625 | 0.750  | RND Ø0.390                 |
| 6       | 20.625 | 29.250 | RND Ø0.390                 |
| 7       | 0.750  | 29.250 | RND Ø0.390                 |
| 8       | 0.750  | 0.750  | RND Ø0.390                 |

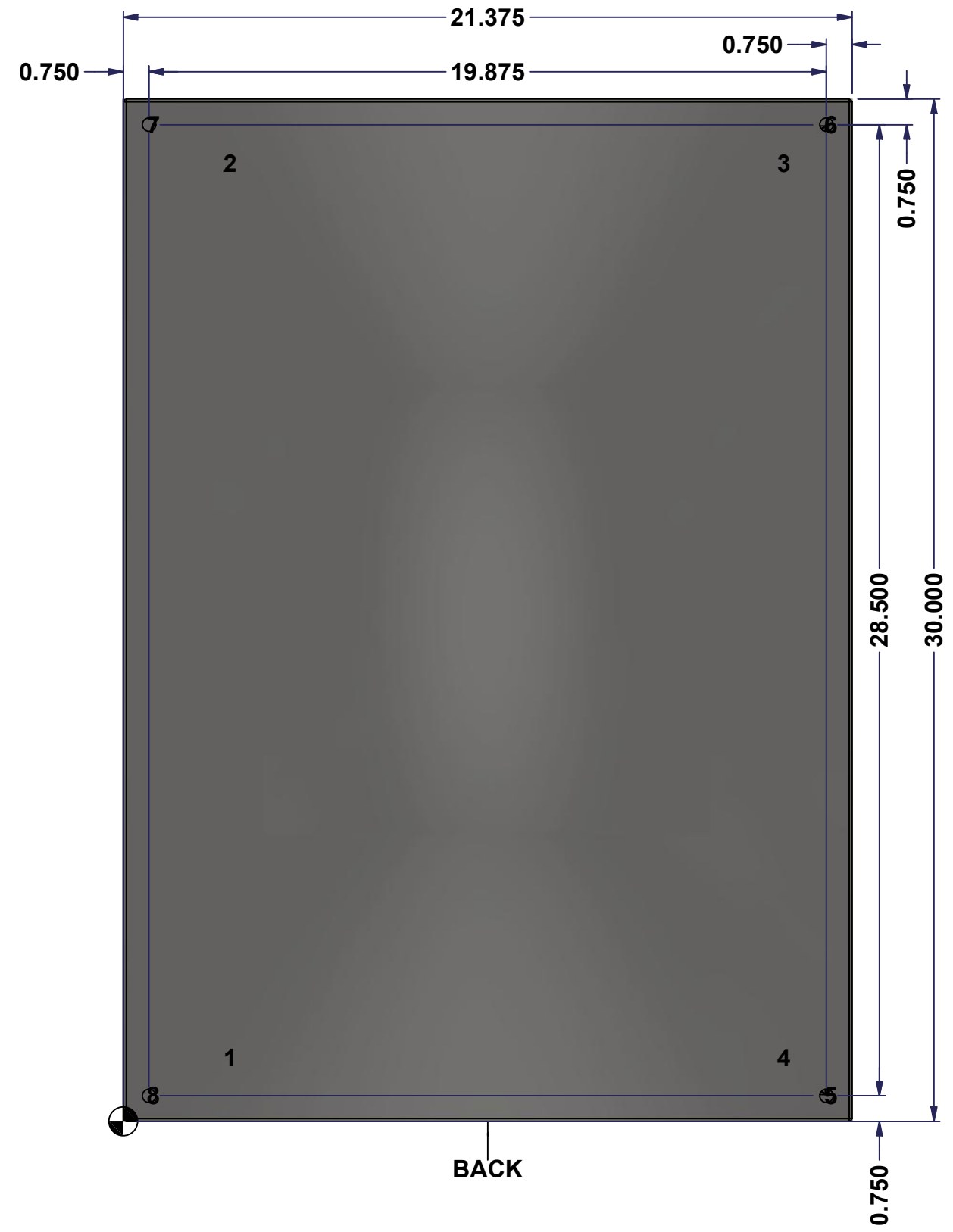

BACK

|  |                                   |        |   |
|--|-----------------------------------|--------|---|
|  | Description                       | Status |   |
|  | 5500ESSY 30" x 21.375" x 10" Body | (NULL) |   |
|  | Part Number                       | Rev.   | 5 |
|  | 5500ESSY302110B                   | 0      | 9 |

This drawing is confidential and must not be reproduced or used without the consent of EXM

Ce dessin est confidentiel et ne doit pas être reproduit ou utilisé sans le consentement de EXM

| No. | Revisions | Date | By/Par |
|-----|-----------|------|--------|
|     |           |      |        |
|     |           |      |        |
|     |           |      |        |
|     |           |      |        |
|     |           |      |        |

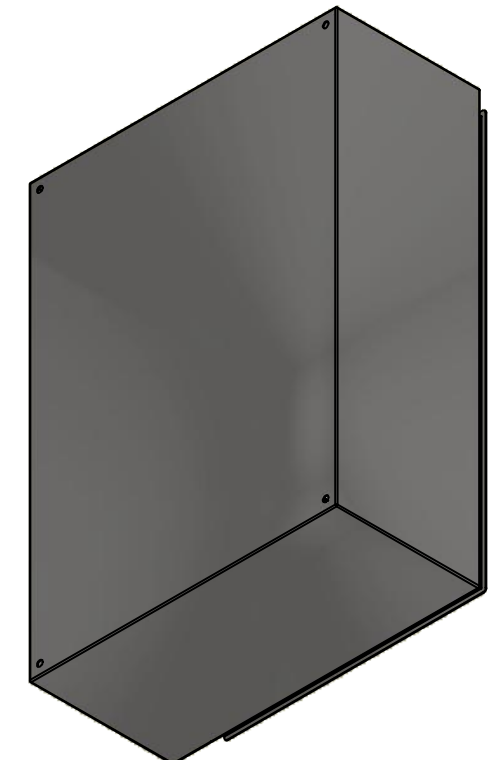

Isometric View

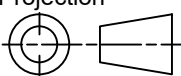

|  |                                   |   |
|--|-----------------------------------|---|
|  Tél: (450) 979-4373<br>Fax: (450) 979-4626<br><a href="http://www.exmweb.com">www.exmweb.com</a> | Flatness<br>Aplatissement         | Max 3.0mm   |
|  | Projection                        |  |
| Customer<br>Client   | Date                              |   |
| Drawn By<br>Dessiné Par  | BoxCad: BoxCad                    | Date 2014-10-27   |
| Material<br>Matière  | 16 Ga Stainless Steel 304 (1.4mm) |   |
| Color<br>Couleur   | Unpainted                         | Finish<br>Fini<br>Brushed   |
| Description  | Detail Rev.                       |   |
| 5500ESSY 30" x 21.375" x 10" Body  |                                   |   |
| Part Number<br>Numéro Pièce  | Rev.                              | 6   |
| <b>5500ESSY302110B</b>   | <b>0</b>                          | 9   |

| Qty        | Part Number       | Rev | Description                            |
|------------|-------------------|-----|--|
| 1          | STK-Q-16085       | 0   | Ground Stud M6 x 16mm Stainless Steel  |
| 4          | STK-Q-16020       | 1   | Stud M8 x 35mm Stainless Steel         |
| 1          | 5500ESSY302110B-P | 0   | 5500ESSY 30" x 21.375" x 10" Body Part |
| Parts List |                   |     |  |

This drawing is confidential and must not be reproduced or used without the consent of EXM

Ce dessin est confidentiel et ne doit pas être reproduit ou utilisé sans le consentement de EXM

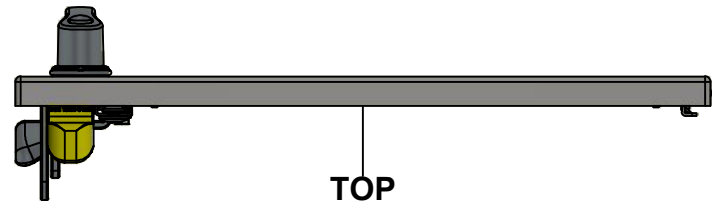

TOP

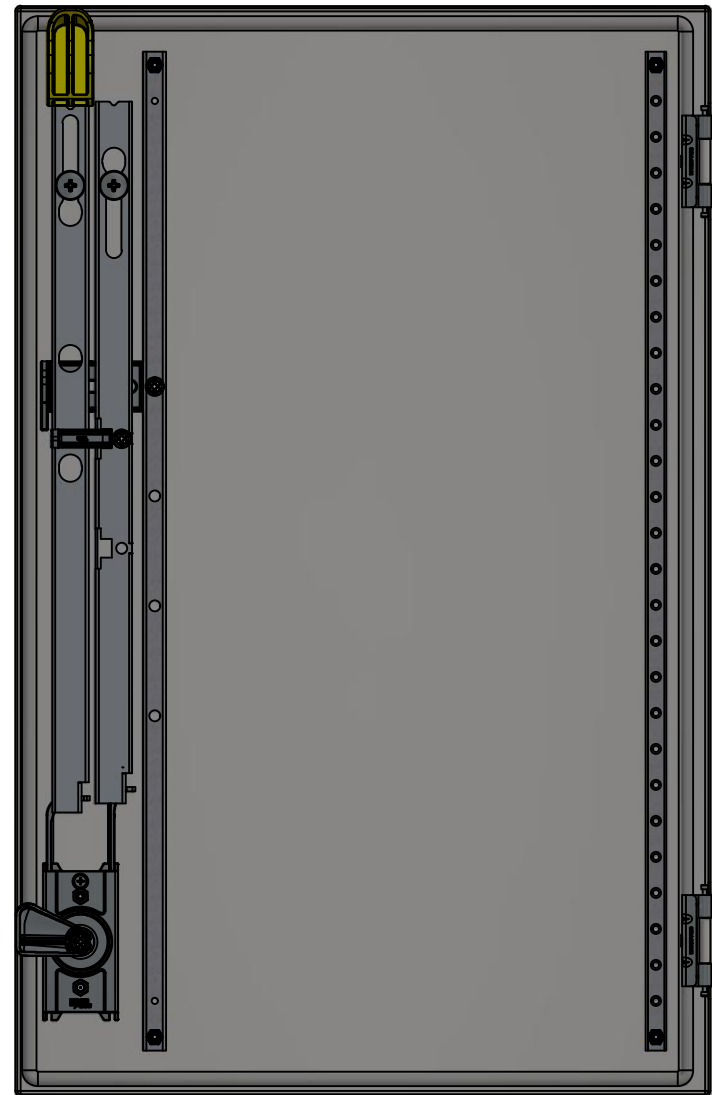

BACK

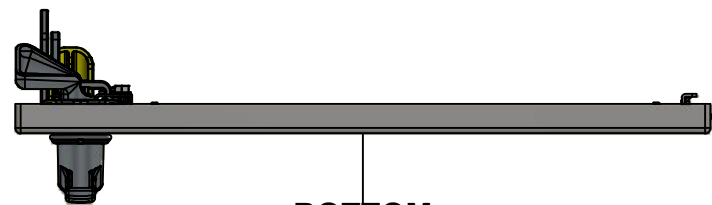

BOTTOM

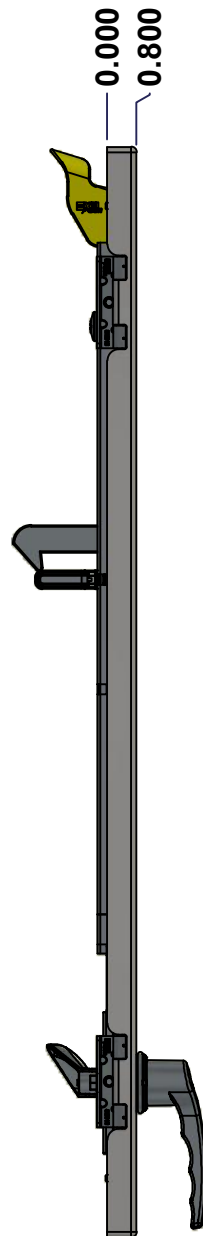

LEFT

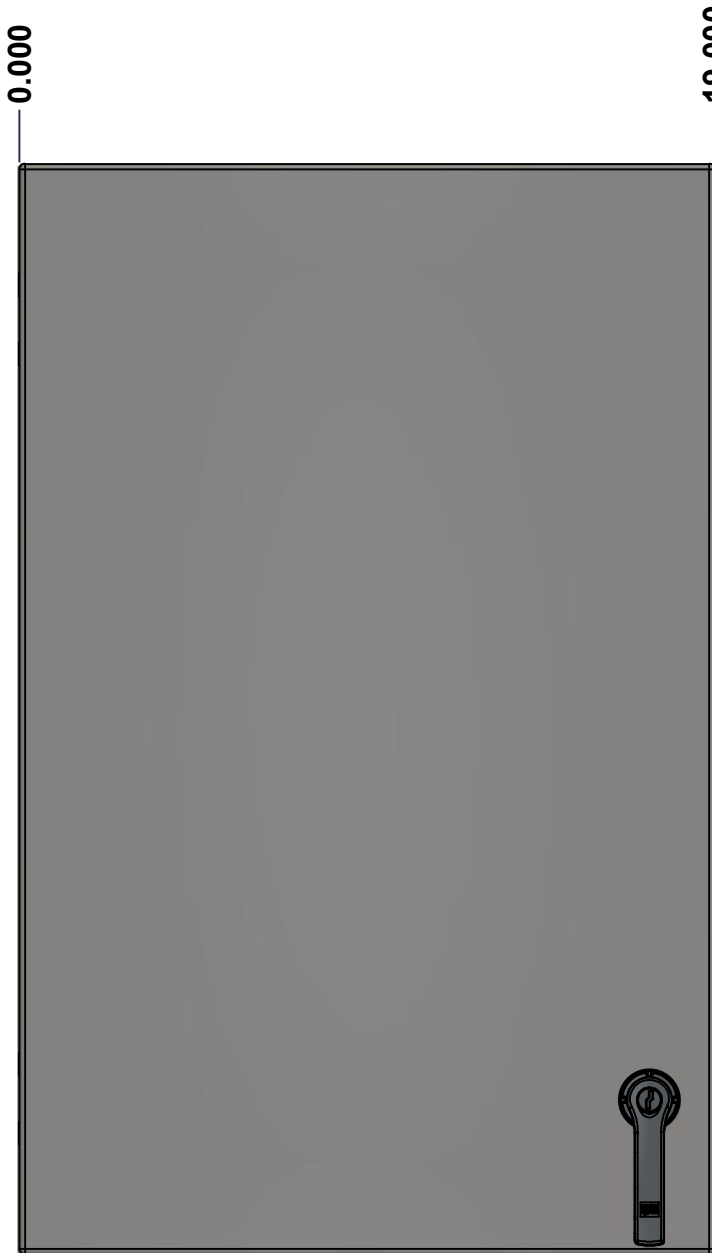

FRONT

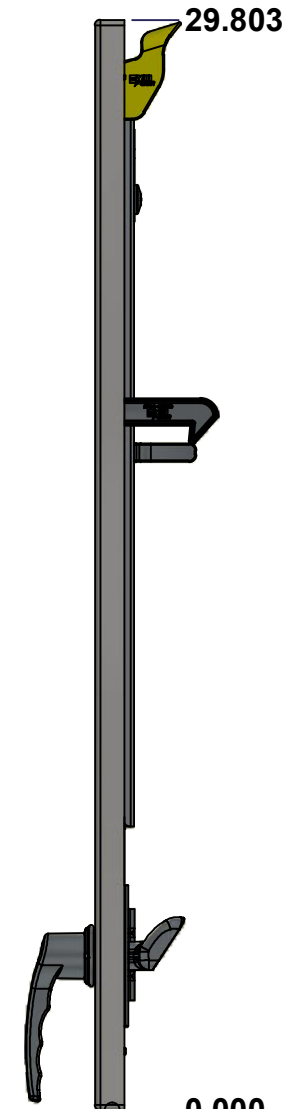

RIGHT

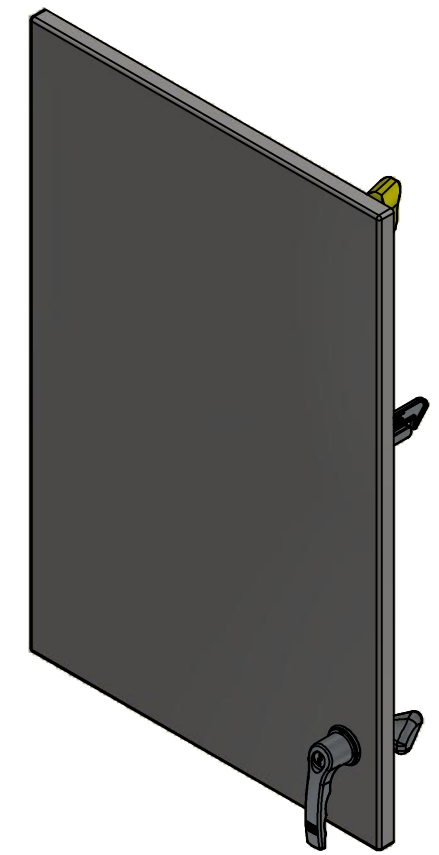

Isometric View

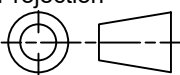

| No. | Revisions | Date | By/Par |
|-----|-----------|------|--------|
|     |           |      |        |
|     |           |      |        |
|     |           |      |        |
|     |           |      |        |
|     |           |      |        |

|  |                                   |   |
|--|-----------------------------------|---|
|  Tél: (450) 979-4373<br>Fax: (450) 979-4626<br><a href="http://www.exmweb.com">www.exmweb.com</a> |                                   | Flatness<br>Aplatissement<br>Max 3.0mm<br>Projection<br> |
| Customer Client  | Date                              |   |
| Drawn By<br>Dessiné Par  | BoxCad: BoxCad                    | Date 2014-10-27   |
| Material<br>Matière  | 16 Ga Stainless Steel 304 (1.4mm) |   |
| Color<br>Couleur   | Unpainted                         | Finish<br>Fini<br>Brushed   |
| Description  | Detail Rev.                       |   |
| 5500ESSY 30" x 21.375" Cover   |                                   |   |
| Part Number<br>Numéro Pièce  | Rev.                              | 7   |
| 5500ESSY302110C  | 0                                 | 9   |

SEE BILL OF MATERIAL ON LAST PAGE

This drawing is confidential and must not be reproduced or used without the consent of EXM

Ce dessin est confidentiel et ne doit pas être reproduit ou utilisé sans le consentement de EXM

**STANDARD FEATURES ARE NOT LISTED IN THIS HOLE TABLE**

**HOLE TABLE - FRONT VIEW (CUSTOM FEATURE ONLY)**

| CUT-OUT | XDIM   | YDIM   | DESCRIPTION                 |
|---------|--------|--------|-----------------------------|
| 1       | 1.486  | 1.614  | STUD M6 x 18mm (Inside)     |
| 2       | 1.486  | 28.189 | STUD M6 x 18mm (Inside)     |
| 3       | 15.194 | 28.189 | STUD M6 x 18mm (Inside)     |
| 4       | 15.194 | 1.614  | STUD M6 x 18mm (Inside)     |
| 5       | 17.496 | 19.401 | STUD M6 x 18mm (Inside)     |
| 6       | 17.496 | 16.401 | STUD M6 x 18mm (Inside)     |
| 7       | 17.496 | 24.896 | STUD M6 x 18mm (Inside)     |
| 8       | 16.311 | 24.896 | STUD M6 x 18mm (Inside)     |
| 9       | 17.219 | 2.969  | STUD M6 x 18mm (Inside)     |
| 10      | 17.219 | 5.469  | STUD M6 x 18mm (Inside)     |
| -----   | -----  | -----  | -----                       |
| 11      | 17.219 | 4.219  | HANDLE 885 ESL2A-LSS @ 0.0° |

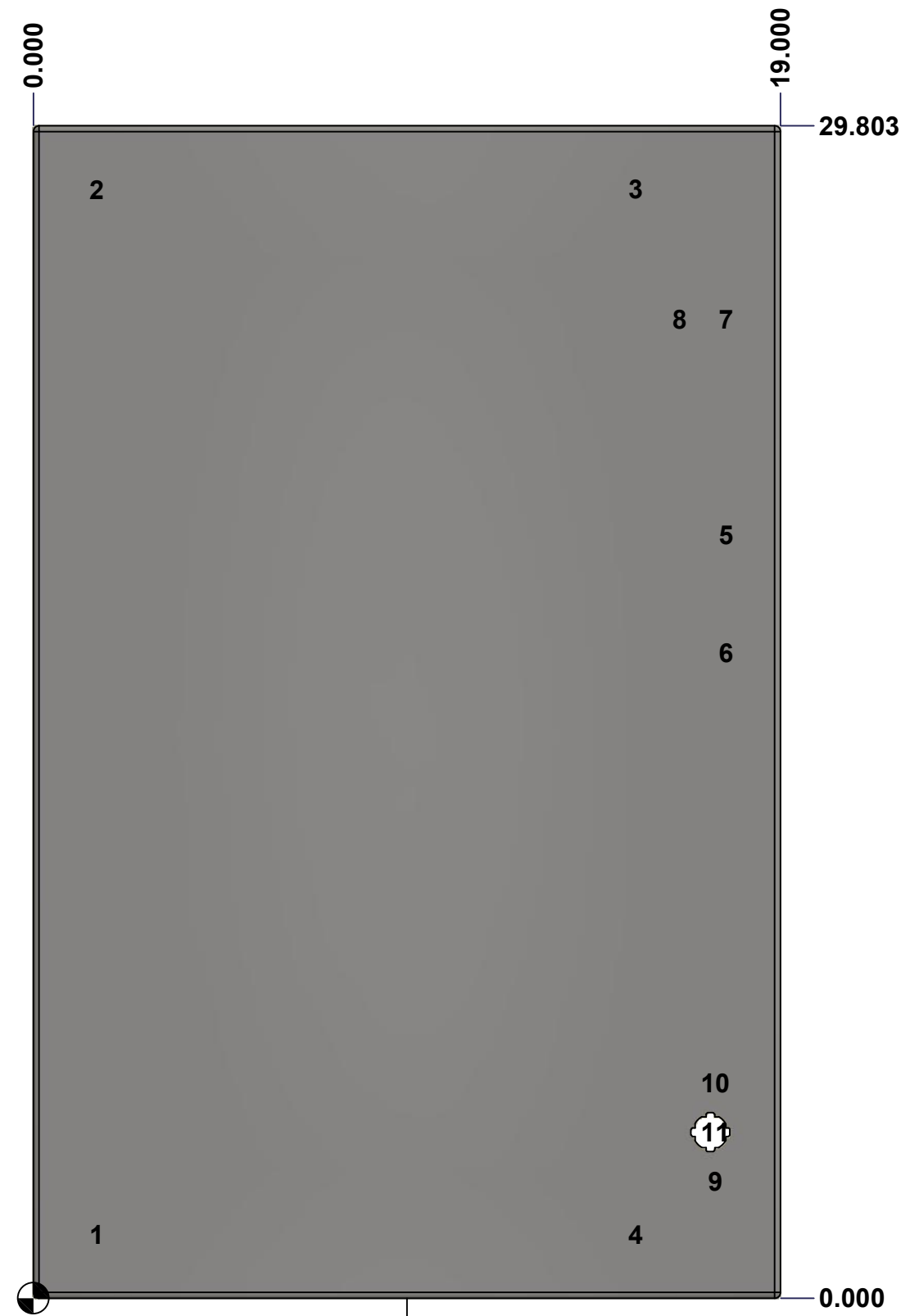

FRONT

|  |                              |  |        |
|--|------------------------------|--|--------|
|  | Description                  |  | Status |
|  | 5500ESSY 30" x 21.375" Cover |  | (NULL) |
|  | Part Number<br>Numéro Pièce  |  | Rev.   |
|  | <b>5500ESSY302110C</b>       |  | 8<br>9 |



This drawing is confidential and must not be reproduced or used without the consent of EXM

Ce dessin est confidentiel et ne doit pas être reproduit ou utilisé sans le consentement de EXM

| No. | Revisions | Date | By/Par |
|-----|-----------|------|--------|
|     |           |      |        |
|     |           |      |        |
|     |           |      |        |
|     |           |      |        |
|     |           |      |        |

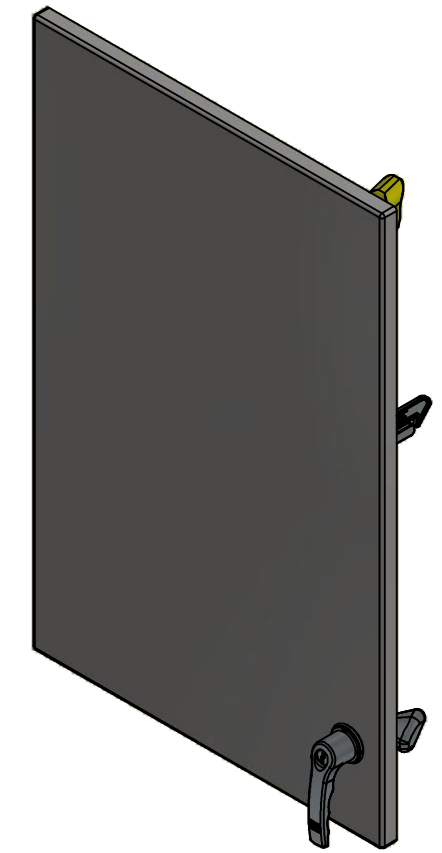

Isometric View



|    |                      |   |  |
|----|----------------------|---|--|
| 1  | STK-A-881DBAR_ESY-30 | 3 | 5500 ESY Defeater Bar 30"              |
| 1  | STK-A-881CBAR_ESY-30 | 4 | 5500 ESY Closing Bar 30"               |
| 1  | STK-K-03890-32       | 3 | Gearbox Clockwise Assembly (Grip 32mm) |
| 1  | 885 ESL2A-LSS        | 3 | 5412 ESS Key Lock L-Handle (3 Pts)     |
| 1  | STK-Q-03200          | 0 | M6 x 8mm Hexagon/Slot Screw            |
| 1  | STK-Q-13060          | 1 | M6 Flat Washer                         |
| 1  | STK-Q-46600          | 3 | 5500 ESY Disconnect Door Hook          |
| 1  | STK-Q-46021-30       | 2 | 5500 ESY Vertical Door Stiffener 30"   |
| 1  | STK-Q-46020-30       | 5 | 5412 ES Vertical Door Stiffener 30"    |
| 10 | STK-Q-16070          | 1 | Stud M6 x 18mm Stainless steel         |
| 1  | 5500ESSY302110G      | 0 | 5500ESSY 30" x 21.375" Cover Gasket    |
| 1  | 5500ESSY302110C-P    | 0 | 5500ESSY 30" x 21.375" Cover Part      |
| 2  | STK-A-33016          | 0 | 5412 ESS Bended Hinge (Body Part)      |
| 5  | STK-Q-07220          | 1 | M6 Nylon Insert Lock Nut               |

| Qty        | Part Name | Rev | Description |
|------------|-----------|-----|-------------|
| Parts List |           |     |             |

|   |  |
|---|--|
|   | Flatness<br>Aplatissement<br>Max 3.0mm |
|   | Projection<br>                         |
| Customer<br>Client                                    | Date                                   |
| Drawn By<br>Dessiné Par BoxCad: BoxCad                | Date 2014-10-27                        |
| Material<br>Matière 16 Ga Stainless Steel 304 (1.4mm) |  |
| Color<br>Couleur Unpainted                            | Finish<br>Fini Brushed                 |
| Description<br>5500ESSY 30" x 21.375" Cover           |  |
| Part Number<br>Numéro Pièce <b>5500ESSY302110C</b>    |  |
| Rev. 0  | 9                                      |

This drawing is confidential and must not be reproduced or used without the consent of EXM

Ce dessin est confidentiel et ne doit pas être reproduit ou utilisé sans le consentement de EXM

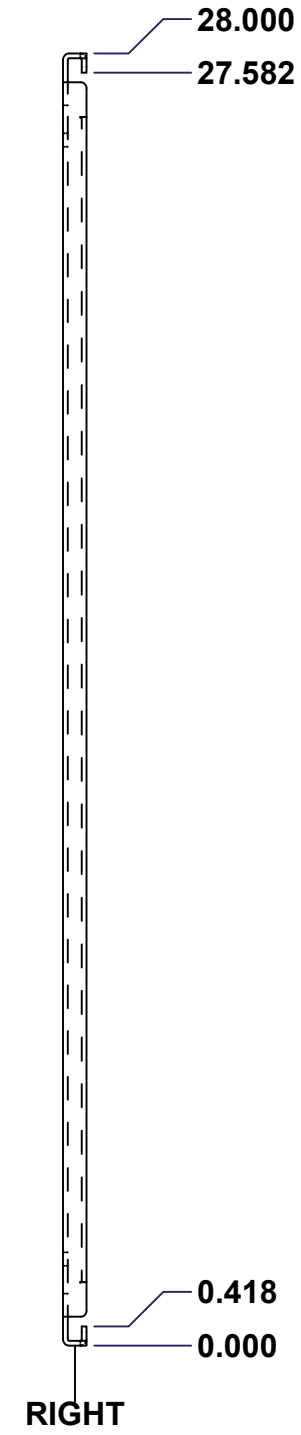
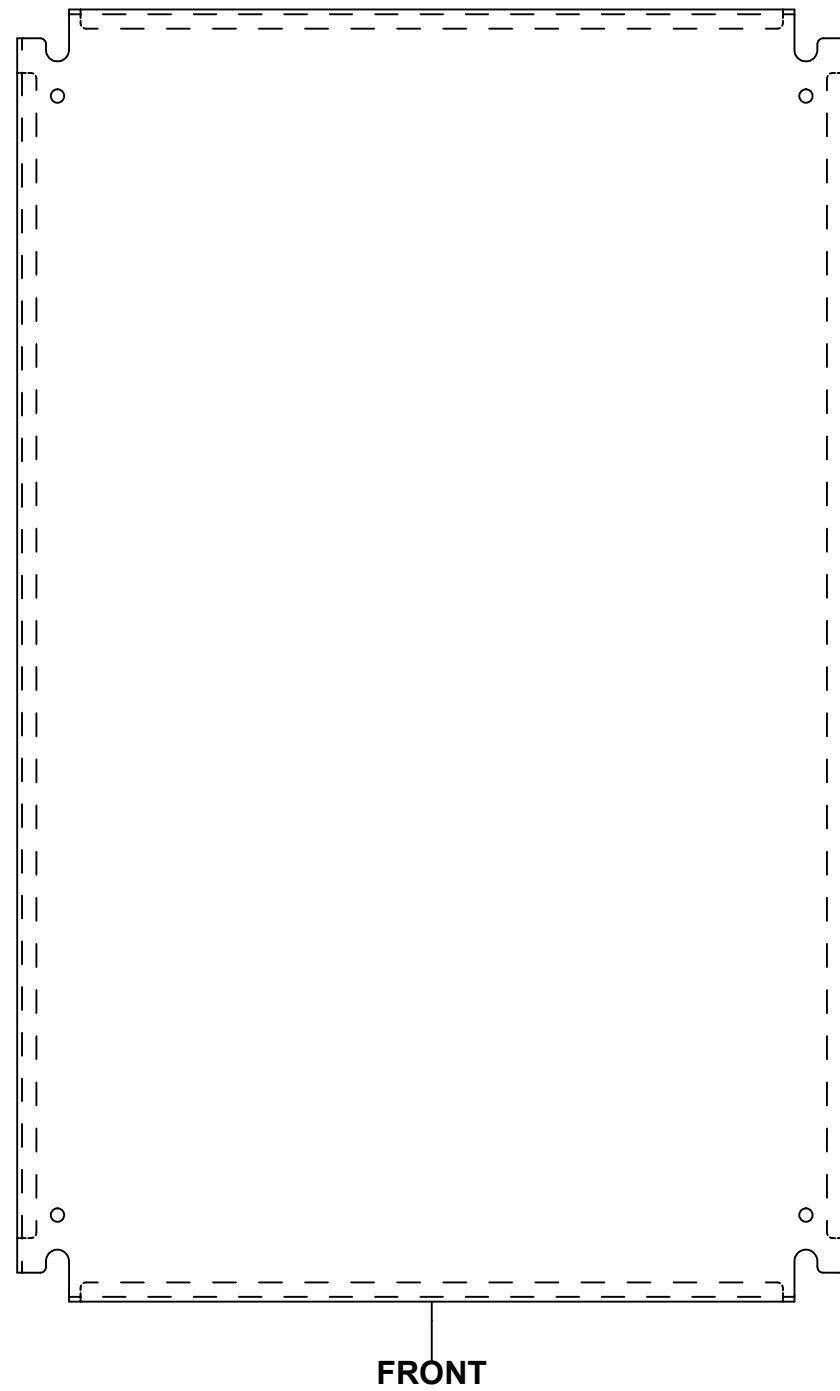
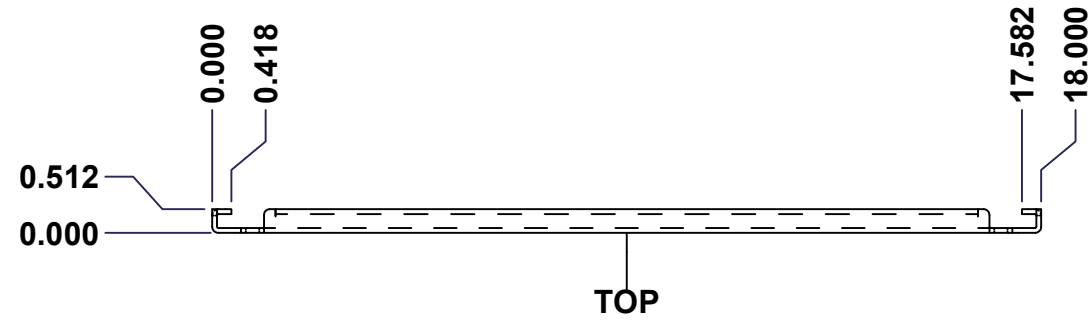

| No. | Revisions | Date | By/Par |
|-----|-----------|------|--------|
|     |           |      |        |
|     |           |      |        |
|     |           |      |        |
|     |           |      |        |

Isometric View

|  |                              |  |
|--|------------------------------|--|
| Tél: (450) 979-4373<br>Fax: (450) 979-4626<br>www.exmweb.com |                              | Flatness<br>Aplatissement<br>Max 3.0mm<br>Projection<br> |
| Customer Client  | Date                         |  |
| Drawn By / Dessiné Par: BoxCad                               | Date: 1/23/2007              |  |
| Material / Matière   | See Part List                |  |
| Color / Couleur: See Part List                               | Finish / Fini: See Part List |  |
| Description: 881 SP - Inner Panel                            |                              | Detail Rev.  |
| Part Number / Numéro Pièce: <b>881 SP3020G</b>               | Rev. <b>0</b>                | 1/2  |

| Qty | Part Number   | Rev | Description               | Material         | Color     | Finish     |
|-----|---------------|-----|---------------------------|------------------|-----------|------------|
| 1   | 881 SP3020G-P | 0   | 881 SP - Inner Panel Part | 12 Ga Galvanized | Unpainted | Galvanized |

Parts List

This drawing is confidential and must not be reproduced or used without the consent of EXM

Ce dessin est confidentiel et ne doit pas être reproduit ou utilisé sans le consentement de EXM

| Table 1 |        |        | FRONT VIEW               |
|---------|--------|--------|--------------------------|
| CUT-OUT | XDIM   | YDIM   | DESCRIPTION              |
| 1       | 0.875  | 1.875  | GROUND HOLE (RND Ø0.290) |
| 2       | 17.125 | 1.875  | GROUND HOLE (RND Ø0.290) |
| 3       | 0.875  | 26.125 | GROUND HOLE (RND Ø0.290) |
| 4       | 17.125 | 26.125 | GROUND HOLE (RND Ø0.290) |

All knockouts are actual size / Les disques défonçables sont grandeur réel

| No. | Revisions | Date | By/Par |
|-----|-----------|------|--------|
|     |           |      |        |
|     |           |      |        |
|     |           |      |        |
|     |           |      |        |
|     |           |      |        |

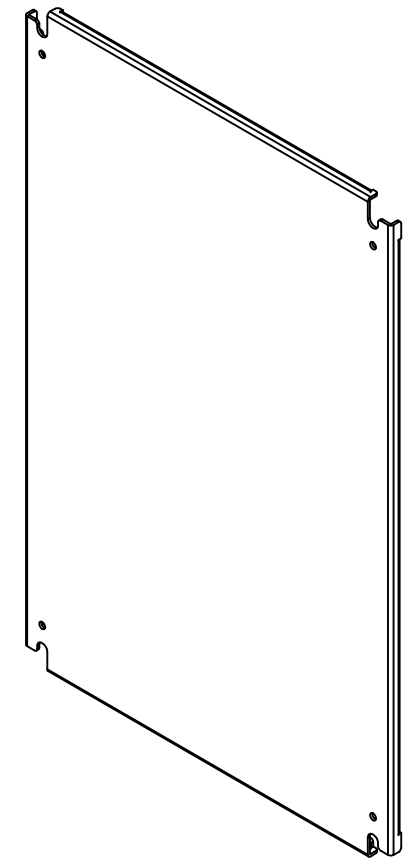
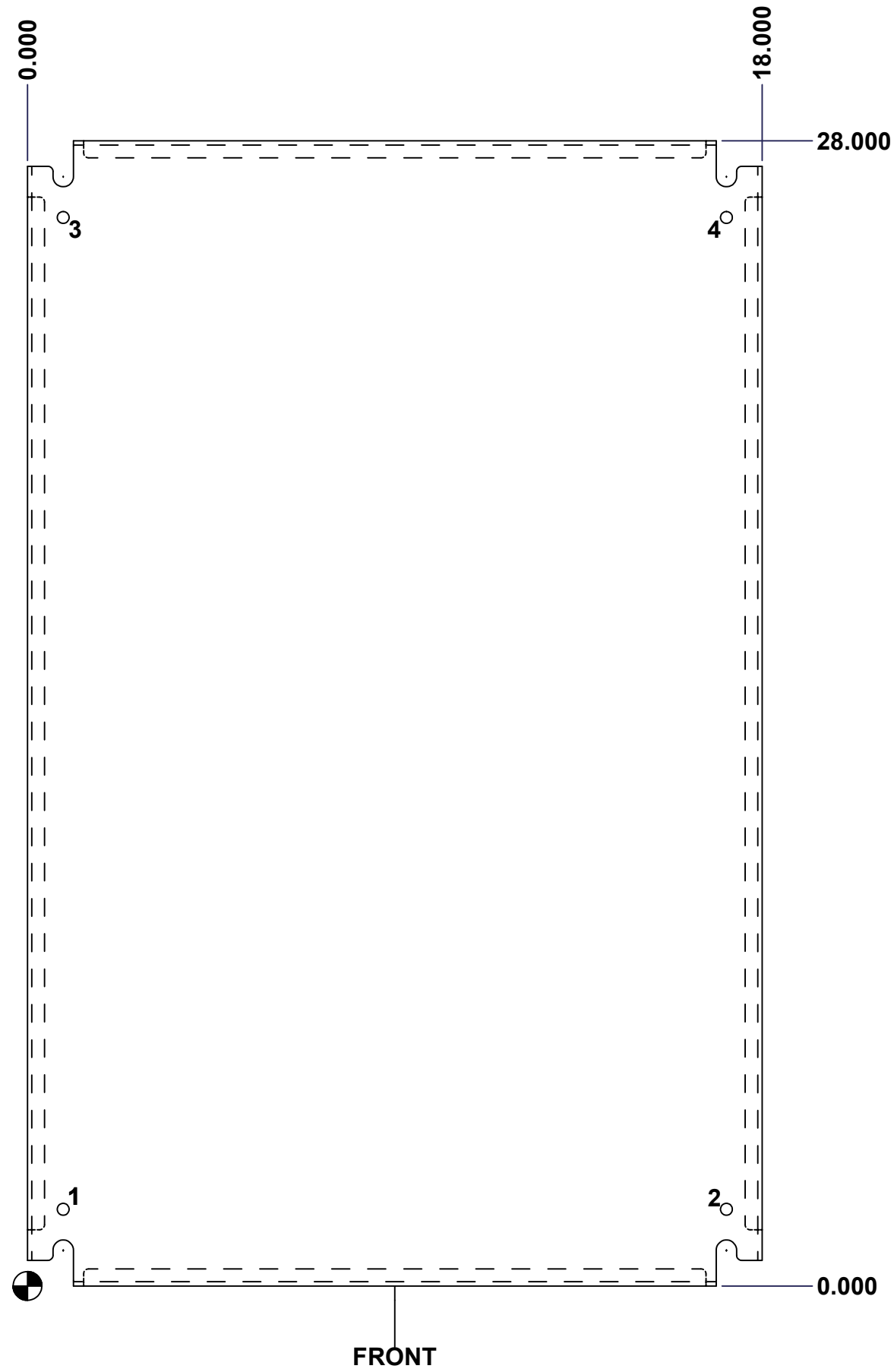

Isometric View

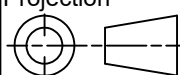

|  |   |
|--|---|
|  Tél: (450) 979-4373<br>Fax: (450) 979-4626<br>www.exmweb.com | Flatness<br>Aplatissement<br>Max 3.0mm  |
|  | Projection<br> |
| Customer Client  | Date  |
| Drawn By<br>Dessiné Par BoxCad   | Date 1/23/2007  |
| Material<br>Matière  | See Part List   |
| Color<br>Couleur   | See Part List   |
| Finish<br>Fini   | See Part List   |
| Description<br>881 SP - Inner Panel  | Detail Rev.   |
| Part Number<br>Numéro Pièce<br><b>881 SP3020G</b>  | Rev. 0  |

|   |
|---|
| 2 |
| 2 |