

This drawing is confidential and must not be reproduced or used without the consent of EXM

Ce dessin est confidentiel et ne doit pas être reproduit ou utilisé sans le consentement de EXM

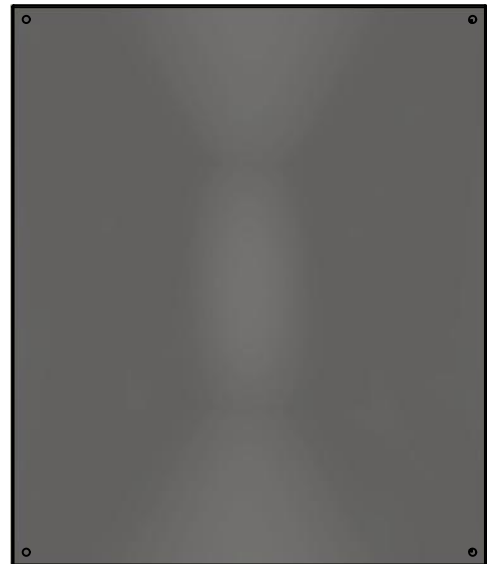

TOP



BACK



LEFT

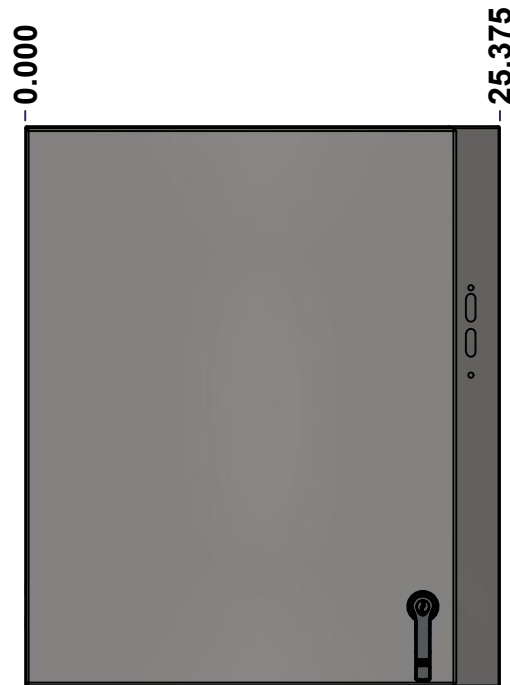

FRONT

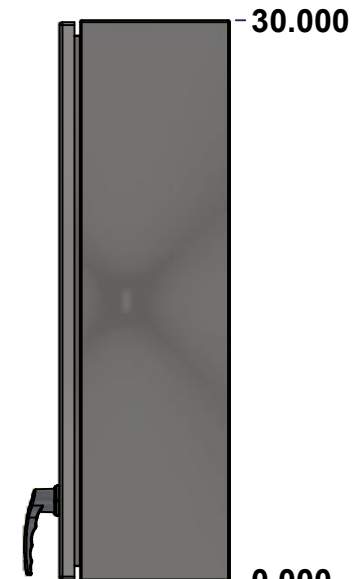

RIGHT

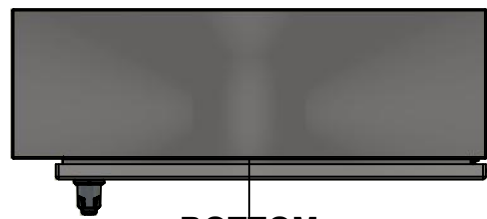

BOTTOM

No.	Revisions	Date	By/Par

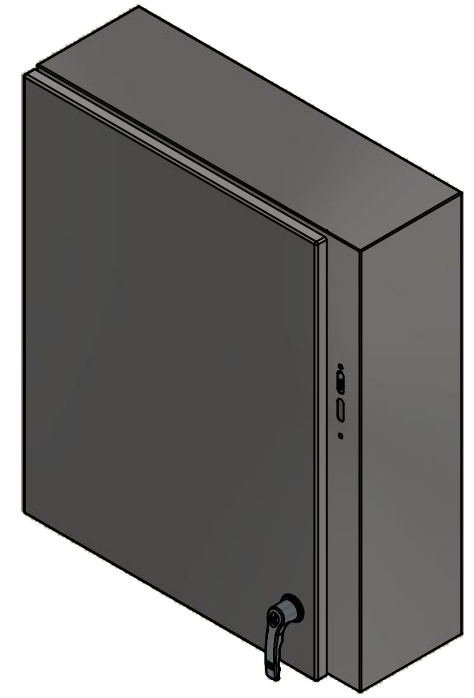

Isometric View



Tél: (450) 979-4373
 Fax: (450) 979-4626
www.exmweb.com

Flatness
Aplatissement
Max 3.0mm
Projection

Customer Client	Date
Drawn By / Dessiné Par: BoxCad: BoxCad	Date: 10/28/2014
Material / Matière: 16 Ga Stainless Steel 304 (1.4mm)	
Color / Couleur: Unpainted	Finish / Fini: Brushed
Description: 5500ESSY 30" x 25.375" x 8" Assembly	Detail Rev.
Part Number / Numéro Pièce: 5500ESSY302508	Rev. 1

SEE BILL OF MATERIAL ON LAST PAGE

This drawing is confidential and must not be reproduced or used without the consent of EXM

Ce dessin est confidentiel et ne doit pas être reproduit ou utilisé sans le consentement de EXM

NOTE	
ITEM	DESCRIPTION
1	NEMA 12/13 Enclosure
2	C/W Standard ground studs on box and cover
3	C/W Standard door stiffener
4	C/W Standard inner panel (Included)
5	C/W Standard inner panel mounting studs
6	C/W 880 PP included (Not installed)

No.	Revisions	Date	By/Par

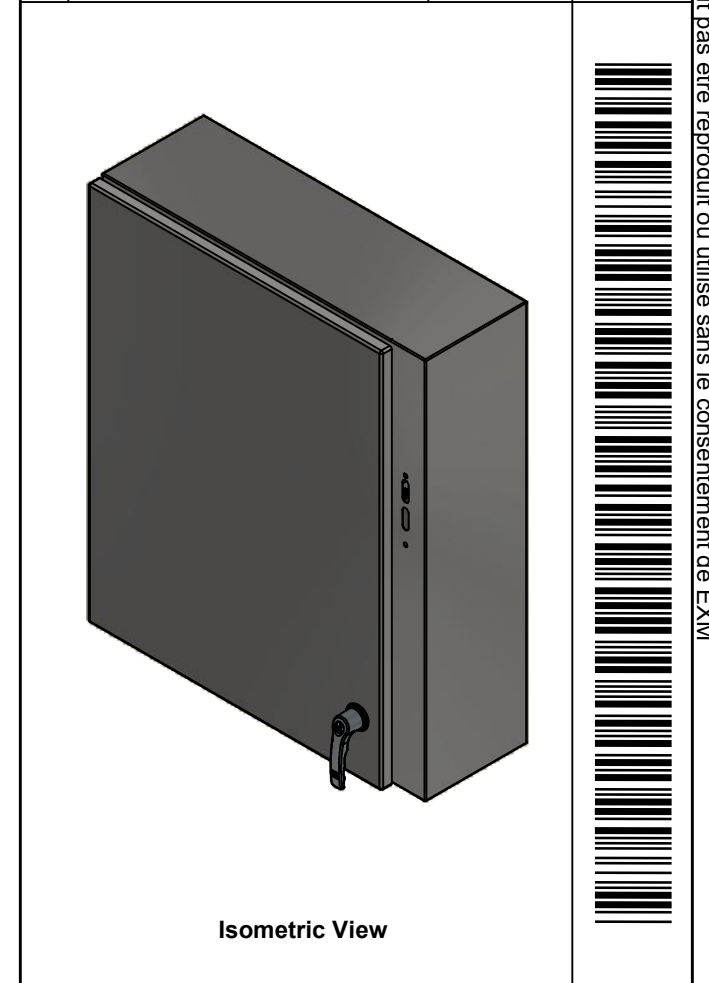

EXM
www.exm.com

Tél: (450) 979-4373
Fax: (450) 979-4626
www.exmweb.com

Flatness
Aplatissement
Max 3.0mm

Projection

Customer Client	Date
Drawn By Dessiné Par	Date 10/28/2014
Material Matière	16 Ga Stainless Steel 304 (1.4mm)

Color Couleur	Unpainted	Finish Fini	Brushed
Description		Detail Rev.	
5500ESSY 30" x 25.375" x 8" Assembly			
Part Number Numéro Pièce	Rev.	2	
5500ESSY302508	0	9	

1	STK-K-01800	5	5412 ES Accessory Kit
1	880 PP	6	Self Adhesive Print Pocket
1	5500ESSY302508C	0	5500ESSY 30" x 25.375" Cover
4	STK-Q-07310	2	Flange Lock Nut M8
1	881 SP3024G	0	881 SP - Inner Panel
4	STK-Q-07610	8	M8 Plastic Spacer 22.2mm
1	5500ESSY302508B	0	5500ESSY 30" x 25.375" x 8" Body
2	STK-Q-04051-07	8	M6 x 7mm Stainless Steel Hexagon Socket Head Machine Screw with Nyseal
Qty	Part Number	Rev	Description
Parts List			

PACKING		
ITEM	QTY	DESCRIPTION
Cardboard sleeve	2	Top and Bottom
Cardboard strip	2	Between back of enclosure and inner panel
Plastic bag	1	To protect cover surface and inside gasket
Plastic strap - Black	2	To Squeeze the 2 cardboard sleeve together
Packaging label	1	White label with product number

This drawing is confidential and must not be reproduced or used without the consent of EXM

Ce dessin est confidentiel et ne doit pas être reproduit ou utilisé sans le consentement de EXM



TOP

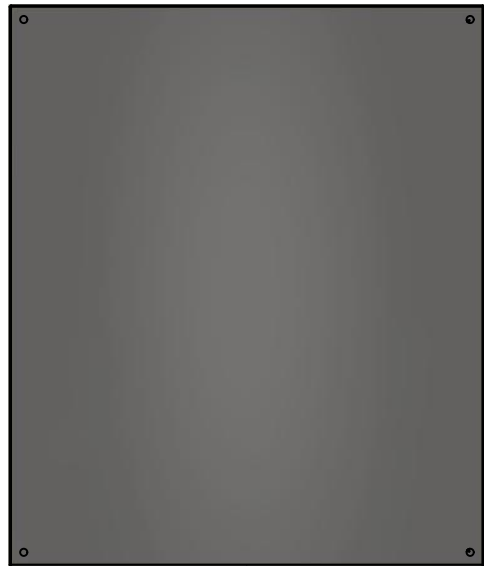

BACK



LEFT

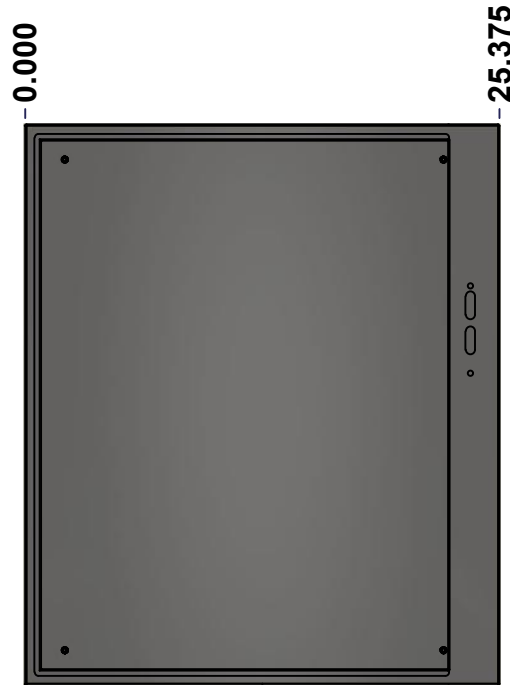

FRONT

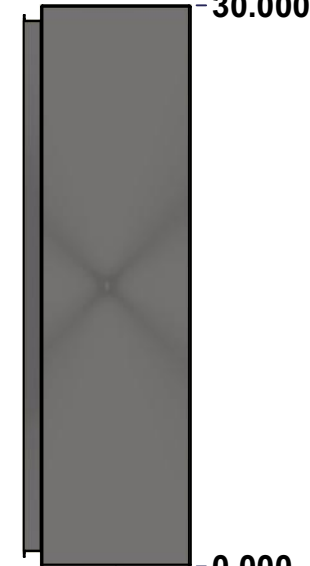

RIGHT



BOTTOM

No.	Revisions	Date	By/Par

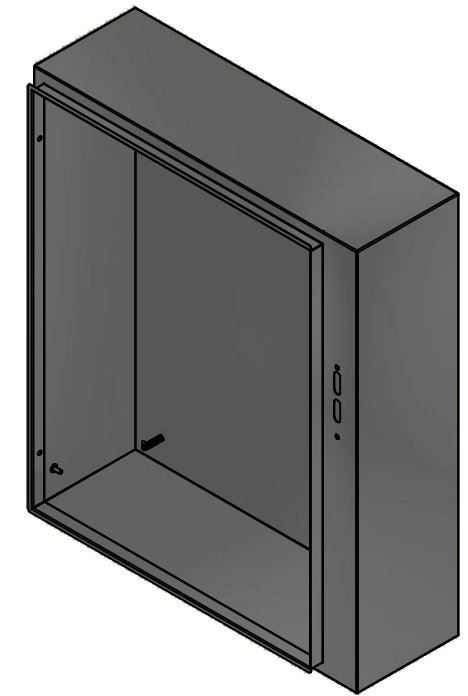

Isometric View



Tél: (450) 979-4373
 Fax: (450) 979-4626
www.exmweb.com

Flatness
Aplatissement

Max 3.0mm

Projection



Customer Client	Date
Drawn By / Dessiné Par: BoxCad: BoxCad	Date: 10/28/2014
Material / Matière: 16 Ga Stainless Steel 304 (1.4mm)	
Color / Couleur: Unpainted	Finish / Fini: Brushed
Description: 5500ESSY 30" x 25.375" x 8" Body	Detail Rev.
Part Number / Numéro Pièce: 5500ESSY302508B	Rev. 3
	9

SEE BILL OF MATERIAL ON LAST PAGE

This drawing is confidential and must not be reproduced or used without the consent of EXM

Ce dessin est confidentiel et ne doit pas être reproduit ou utilisé sans le consentement de EXM

STANDARD FEATURES ARE NOT LISTED IN THIS HOLE TABLE			
HOLE TABLE - LEFT VIEW (CUSTOM FEATURE ONLY)			
CUT-OUT	XDIM	YDIM	DESCRIPTION
1	6.500	2.000	GND STUD M6 x 16mm (Inside)

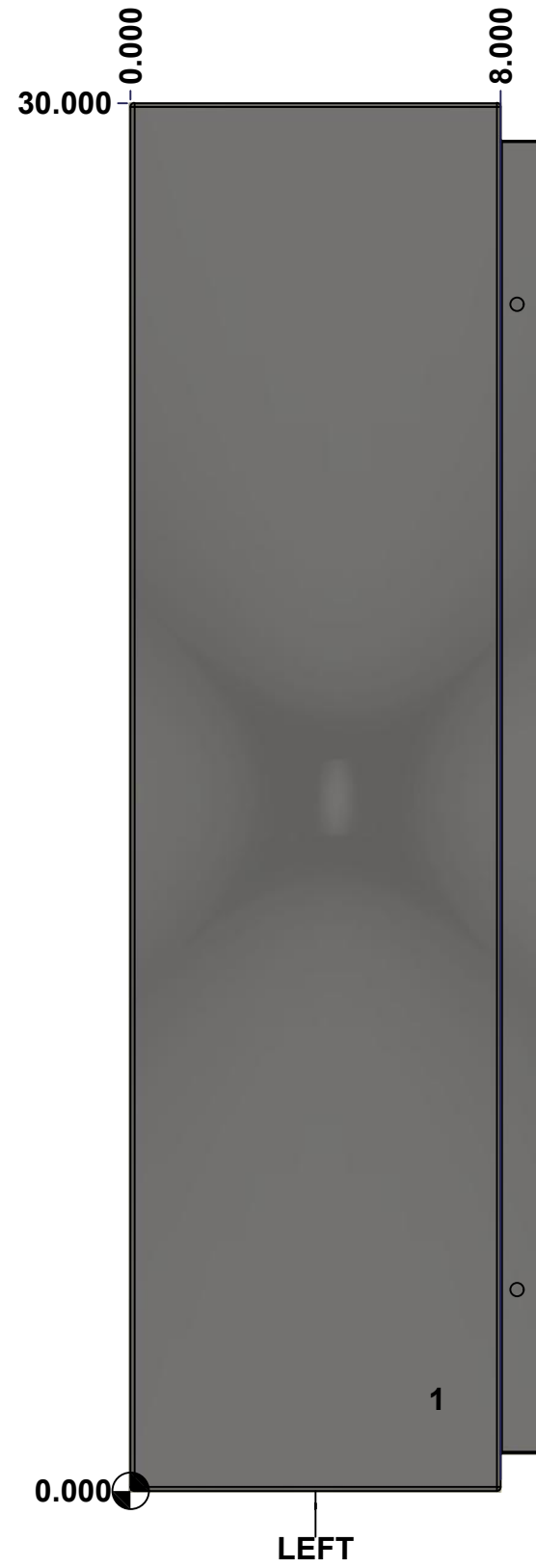

	Description	Status	
	5500ESSY 30" x 25.375" x 8" Body	(NULL)	
	Part Number Numéro Pièce	Rev.	
	5500ESSY302508B	0	4/9

This drawing is confidential and must not be reproduced or used without the consent of EXM

Ce dessin est confidentiel et ne doit pas être reproduit ou utilisé sans le consentement de EXM

STANDARD FEATURES ARE NOT LISTED IN THIS HOLE TABLE

HOLE TABLE - BACK VIEW (CUSTOM FEATURE ONLY)

CUT-OUT	XDIM	YDIM	DESCRIPTION
1	3.000	1.875	IP STUD M8 x 35mm (Inside)
2	3.000	28.125	IP STUD M8 x 35mm (Inside)
3	23.250	28.125	IP STUD M8 x 35mm (Inside)
4	23.250	1.875	IP STUD M8 x 35mm (Inside)

5	24.625	0.750	RND Ø0.390
6	24.625	29.250	RND Ø0.390
7	0.750	29.250	RND Ø0.390
8	0.750	0.750	RND Ø0.390

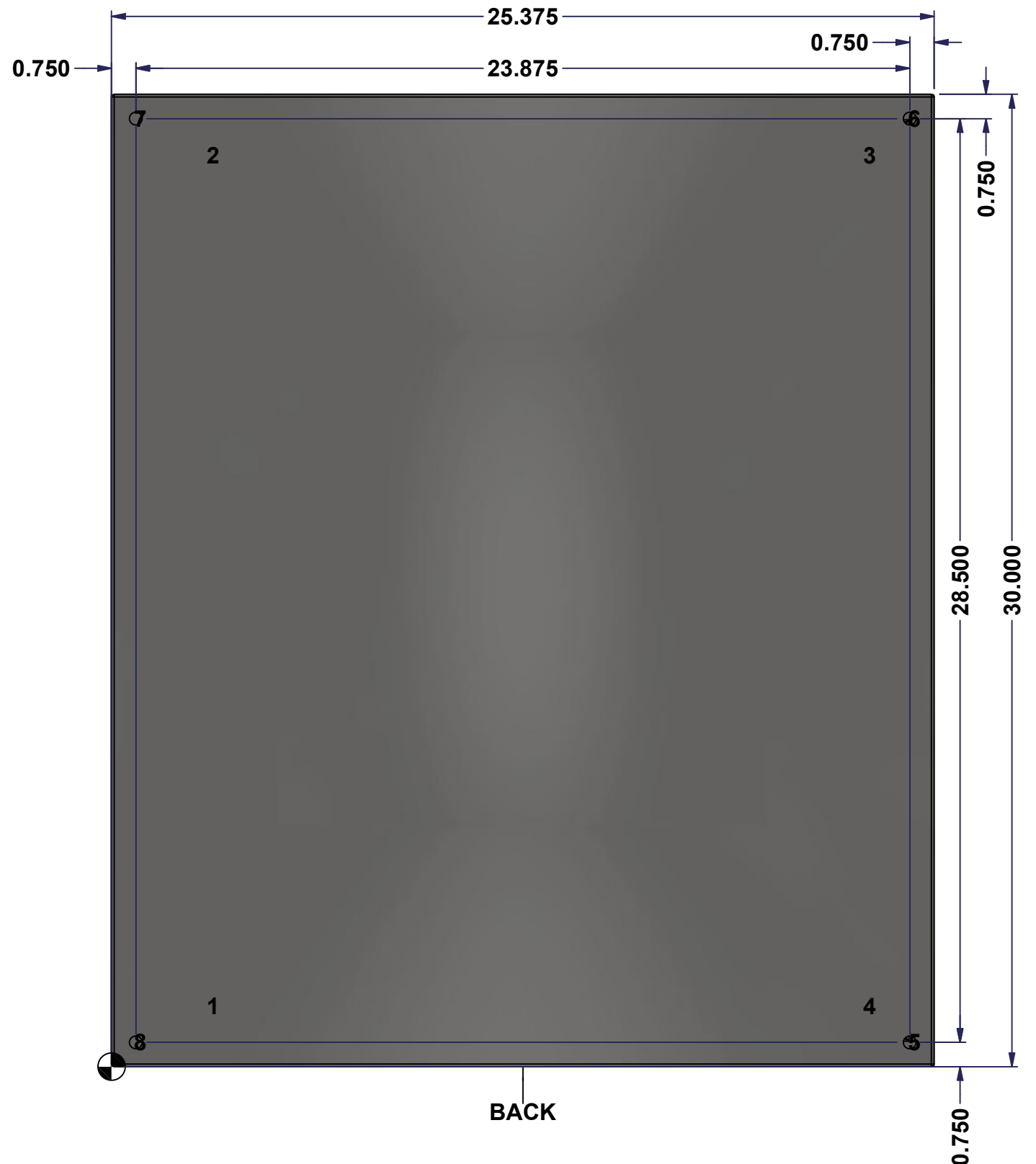

BACK

	Description	Status	
	5500ESSY 30" x 25.375" x 8" Body	(NULL)	
	Part Number Numéro Pièce	Rev.	
	5500ESSY302508B	0	5 9

This drawing is confidential and must not be reproduced or used without the consent of EXM

Ce dessin est confidentiel et ne doit pas être reproduit ou utilisé sans le consentement de EXM

No.	Revisions	Date	By/Par

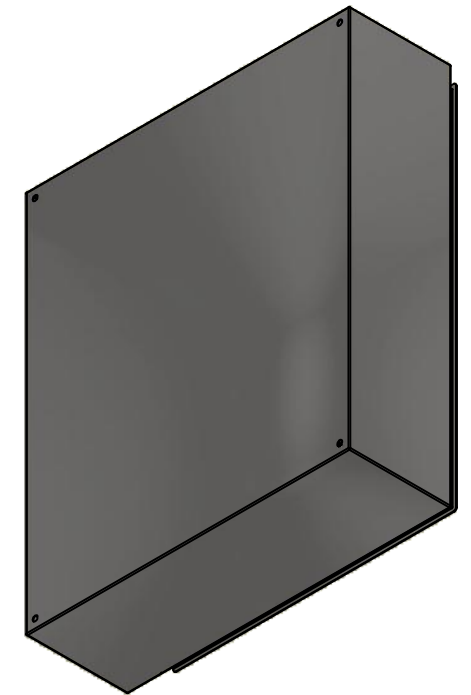

Isometric View



 Tél: (450) 979-4373 Fax: (450) 979-4626 www.exmweb.com		Flatness Aplatissement Max 3.0mm
Customer Client		Date
Drawn By / Dessiné Par: BoxCad: BoxCad		Date: 10/28/2014
Material / Matière: 16 Ga Stainless Steel 304 (1.4mm)		
Color / Couleur: Unpainted	Finish / Fini: Brushed	
Description: 5500ESSY 30" x 25.375" x 8" Body		Detail Rev.
Part Number / Numéro Pièce: 5500ESSY302508B		Rev. 6 0 / 9

Qty	Part Number	Rev	Description
1	STK-Q-16085	0	Ground Stud M6 x 16mm Stainless Steel
4	STK-Q-16020	1	Stud M8 x 35mm Stainless Steel
1	5500ESSY302508B-P	0	5500ESSY 30" x 25.375" x 8" Body Part
Parts List			

This drawing is confidential and must not be reproduced or used without the consent of EXM

Ce dessin est confidentiel et ne doit pas être reproduit ou utilisé sans le consentement de EXM

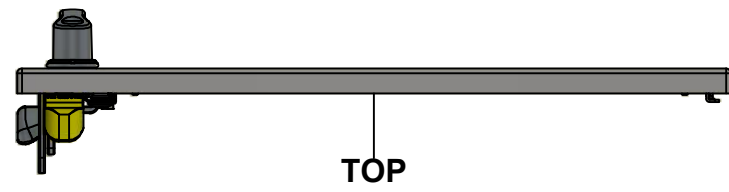

TOP

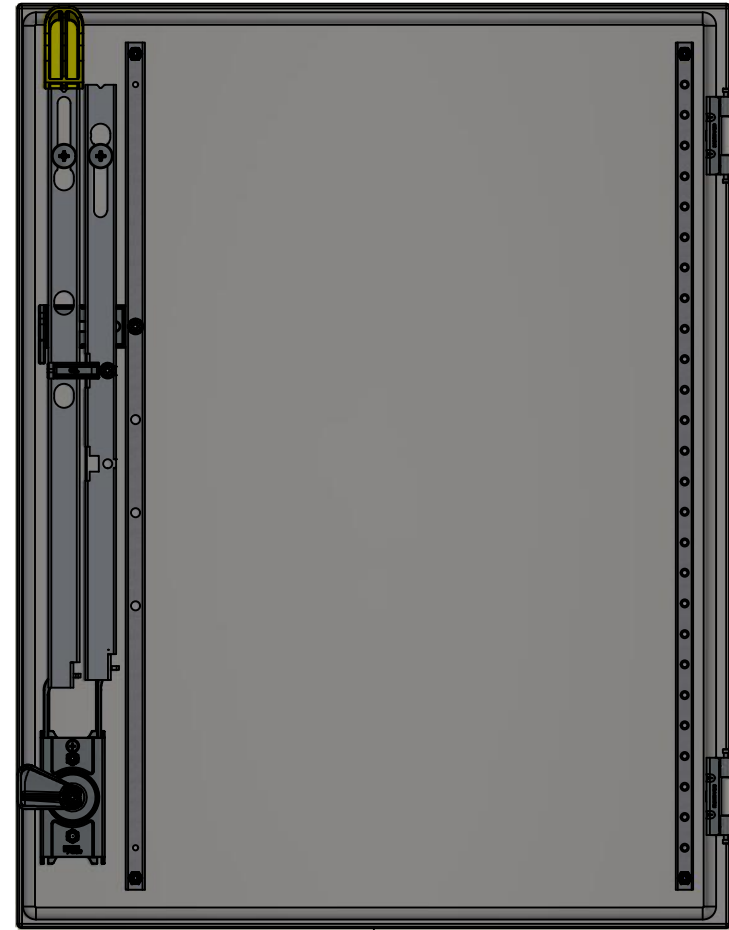

BACK

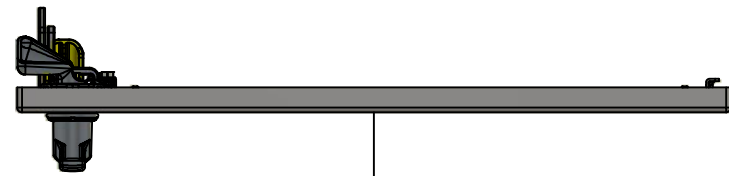

BOTTOM

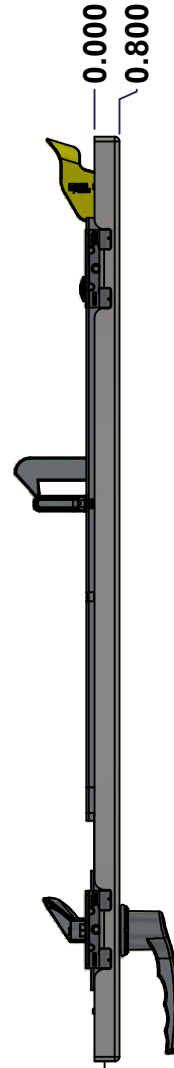

LEFT

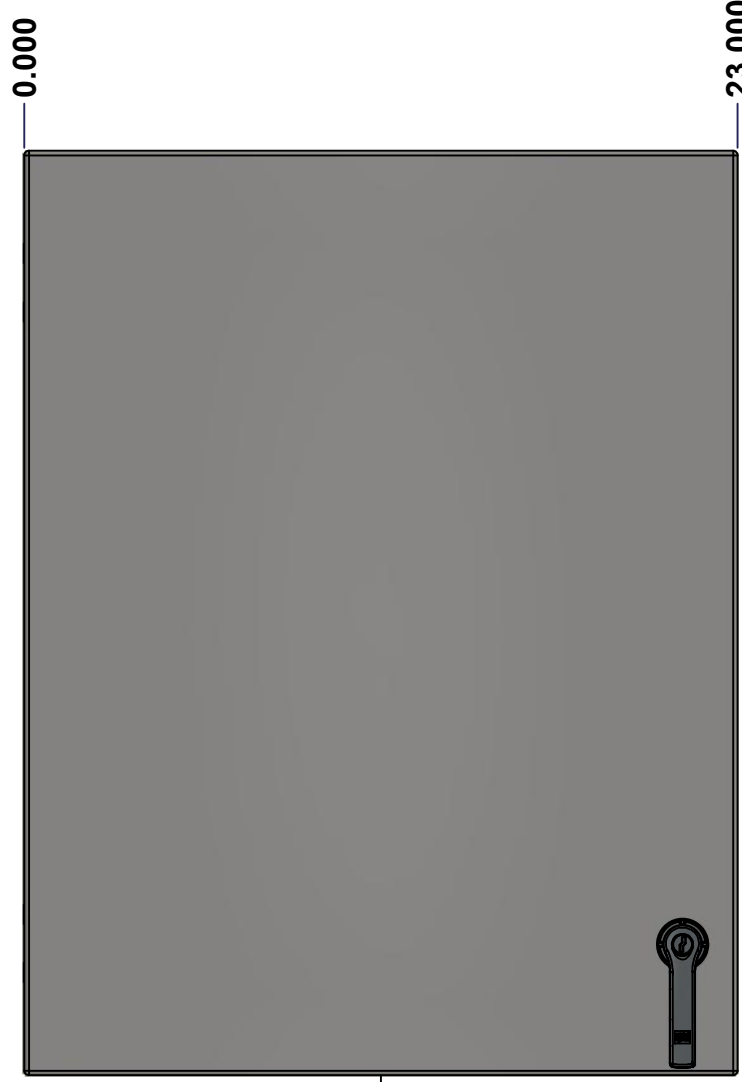

FRONT

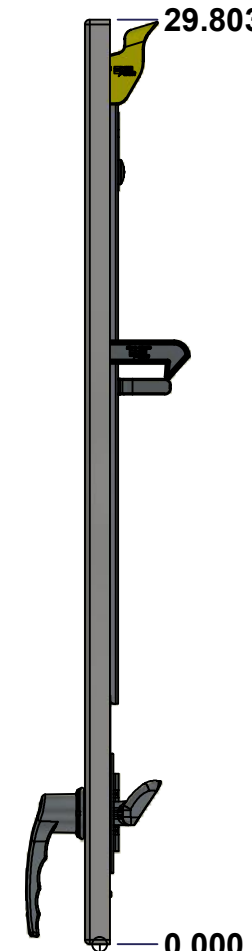

RIGHT

No.	Revisions	Date	By/Par

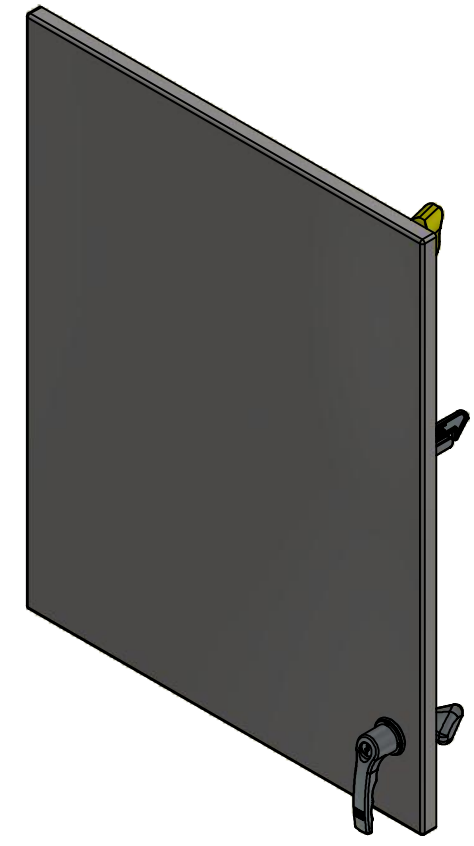

Isometric View



EXM
exm
Tél: (450) 979-4373
Fax: (450) 979-4626
www.exmweb.com

Flatness
Aplatissement
Max 3.0mm
Projection

Customer Client
Date
Drawn By Dessiné Par BoxCad: BoxCad
Date 10/28/2014

Material Matière 14 Ga Stainless Steel 304 (1.7mm)

Color Couleur Unpainted
Finish Fini Brushed

Description 5500ESSY 30" x 25.375" Cover
Detail Rev.

Part Number Numéro Pièce **5500ESSY302508C**
Rev. 7
0 9

SEE BILL OF MATERIAL ON LAST PAGE

This drawing is confidential and must not be reproduced or used without the consent of EXM

Ce dessin est confidentiel et ne doit pas être reproduit ou utilisé sans le consentement de EXM

STANDARD FEATURES ARE NOT LISTED IN THIS HOLE TABLE

HOLE TABLE - FRONT VIEW (CUSTOM FEATURE ONLY)

CUT-OUT	XDIM	YDIM	DESCRIPTION
1	1.486	1.614	STUD M6 x 18mm (Inside)
2	1.486	28.189	STUD M6 x 18mm (Inside)
3	19.194	28.189	STUD M6 x 18mm (Inside)
4	19.194	1.614	STUD M6 x 18mm (Inside)
5	21.496	19.401	STUD M6 x 18mm (Inside)
6	21.496	16.401	STUD M6 x 18mm (Inside)
7	21.496	24.896	STUD M6 x 18mm (Inside)
8	20.311	24.896	STUD M6 x 18mm (Inside)
9	21.219	2.969	STUD M6 x 18mm (Inside)
10	21.219	5.469	STUD M6 x 18mm (Inside)

-----	-----	-----	-----
11	21.219	4.219	HANDLE 885 ESL2A-LSS @ 0.0°

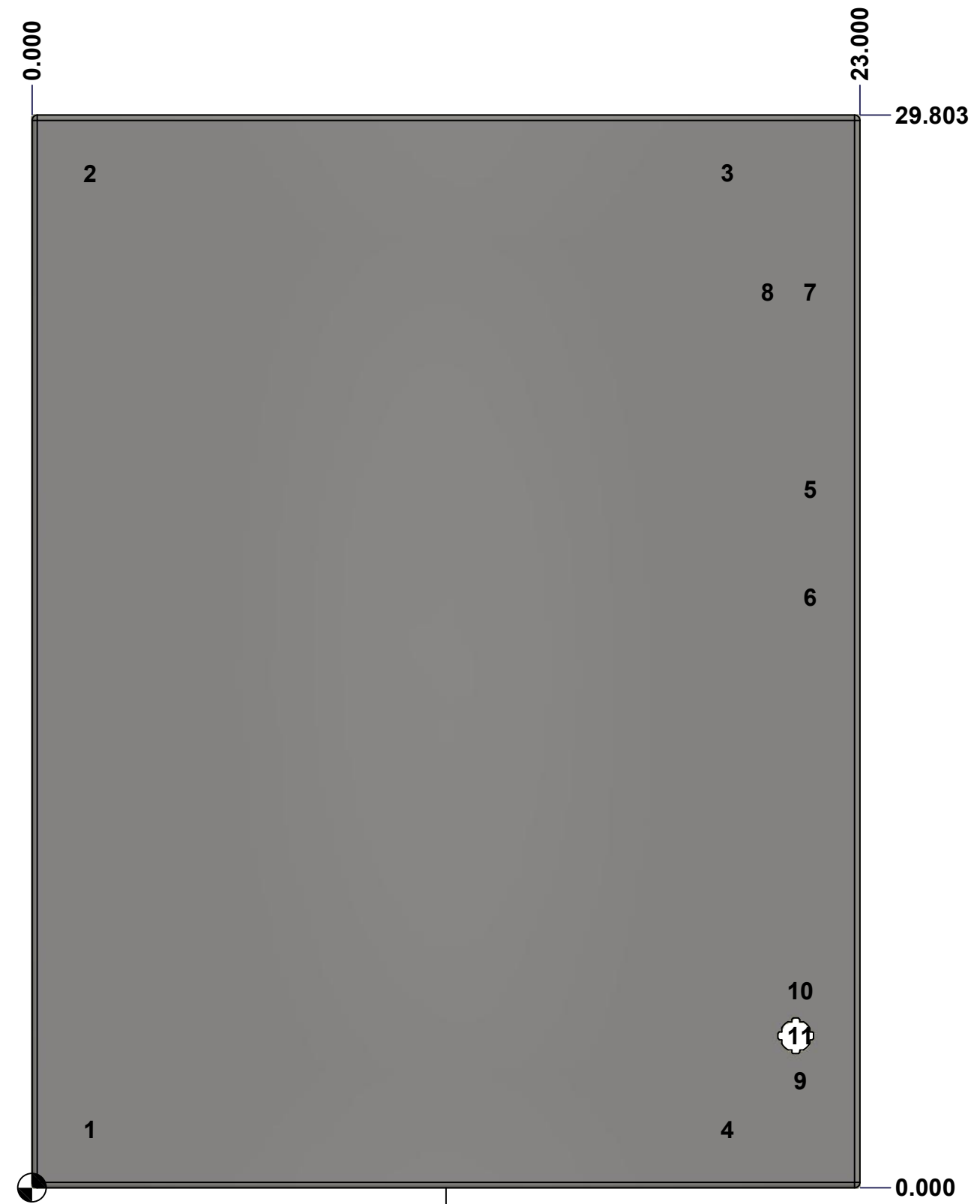

FRONT

	Description	Status	
	5500ESSY 30" x 25.375" Cover	(NULL)	
	Part Number Numéro Pièce	Rev.	
	5500ESSY302508C	0	8 9

This drawing is confidential and must not be reproduced or used without the consent of EXM

Ce dessin est confidentiel et ne doit pas être reproduit ou utilisé sans le consentement de EXM

No.	Revisions	Date	By/Par

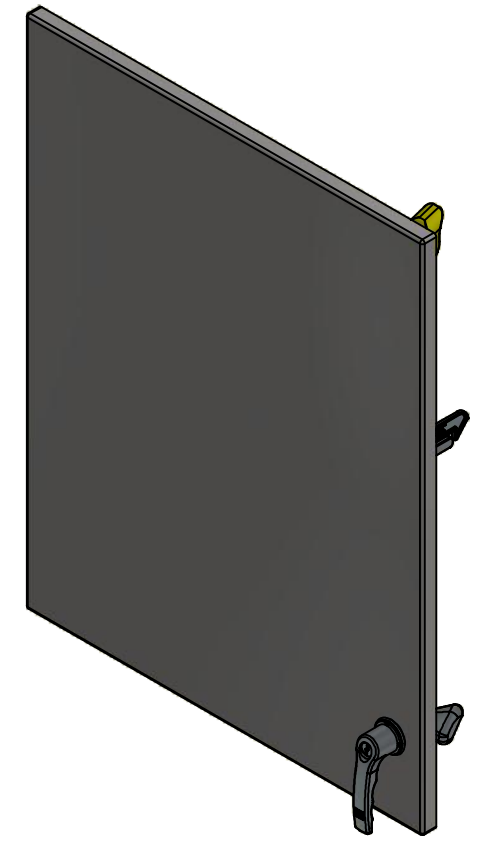

Isometric View



1	STK-A-881DBAR_ESY-30	3	5500 ESY Defeater Bar 30"
1	STK-A-881CBAR_ESY-30	4	5500 ESY Closing Bar 30"
1	STK-K-03890-32	3	Gearbox Clockwise Assembly (Grip 32mm)
1	885 ESL2A-LSS	3	5412 ESS Key Lock L-Handle (3 Pts)
1	STK-Q-03200	0	M6 x 8mm Hexagon/Slot Screw
1	STK-Q-13060	1	M6 Flat Washer
1	STK-Q-46600	3	5500 ESY Disconnect Door Hook
1	STK-Q-46021-30	2	5500 ESY Vertical Door Stiffener 30"
1	STK-Q-46020-30	5	5412 ES Vertical Door Stiffener 30"
10	STK-Q-16070	1	Stud M6 x 18mm Stainless steel
1	5500ESSY302508G	0	5500ESSY 30" x 25.375" Cover Gasket
1	5500ESSY302508C-P	0	5500ESSY 30" x 25.375" Cover Part
2	STK-A-33016	0	5412 ESS Bended Hinge (Body Part)
5	STK-Q-07220	1	M6 Nylon Insert Lock Nut

Qty	Part Name	Rev	Description
Parts List			

Tél: (450) 979-4373 Fax: (450) 979-4626 www.exmweb.com	Flatness Aplatissement	Max 3.0mm
	Projection	
Customer Client	Date	
Drawn By Dessiné Par	BoxCad: BoxCad	Date 10/28/2014
Material Matière	14 Ga Stainless Steel 304 (1.7mm)	
Color Couleur	Unpainted	Finish Fini Brushed
Description	Detail Rev.	
5500ESSY 30" x 25.375" Cover		
Part Number Numéro Pièce	Rev.	9
5500ESSY302508C	0	9

This drawing is confidential and must not be reproduced or used without the consent of EXM

Ce dessin est confidentiel et ne doit pas être reproduit ou utilisé sans le consentement de EXM

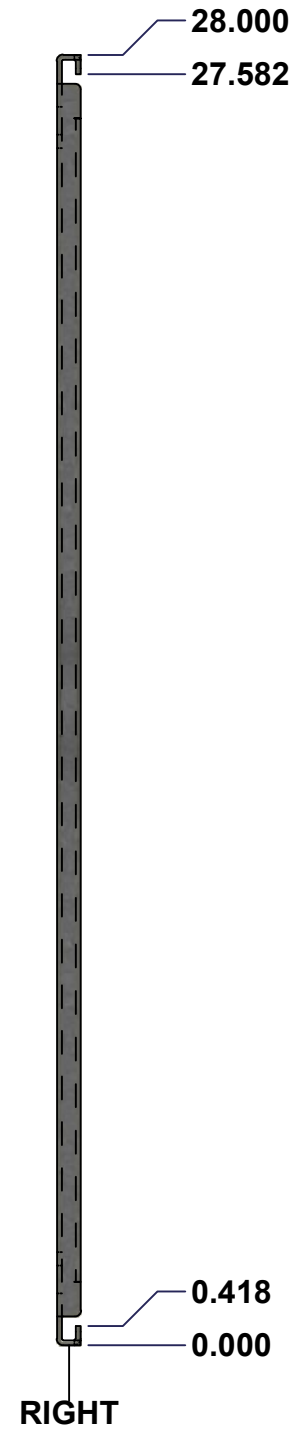
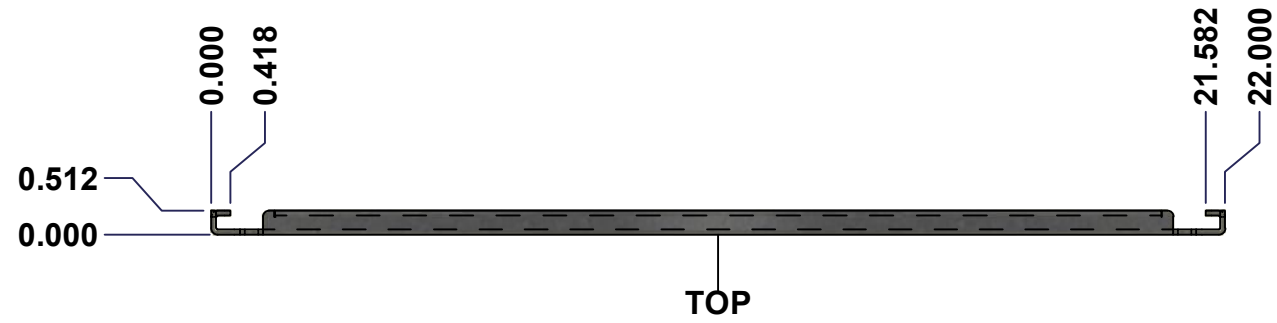

No.	Revisions	Date	By/Par



<p>Tél: (450) 979-4373 Fax: (450) 979-4626 www.exmweb.com</p>	Flatness Aplatissement
	Max 3.0mm
Projection	
Customer Client	Date
Drawn By Dessiné Par BoxCad	Date 1/23/2007
Material Matière	See Part List
Color Couleur	See Part List
Finish Fini	See Part List
Description	Detail Rev.
881 SP - Inner Panel	
Part Number Numéro Pièce	Rev. 1
881 SP3024G	0 2

Qty	Part Number	Rev	Description	Material	Color	Finish
1	881 SP3024G-P	0	881 SP - Inner Panel Part	12 Ga Galvanized	Unpainted	Galvanized

Parts List

This drawing is confidential and must not be reproduced or used without the consent of EXM

Ce dessin est confidentiel et ne doit pas être reproduit ou utilisé sans le consentement de EXM

Table 1			FRONT VIEW
CUT-OUT	XDIM	YDIM	DESCRIPTION
1	0.875	1.875	GROUND HOLE (RND Ø0.290)
2	21.125	1.875	GROUND HOLE (RND Ø0.290)
3	0.875	26.125	GROUND HOLE (RND Ø0.290)
4	21.125	26.125	GROUND HOLE (RND Ø0.290)

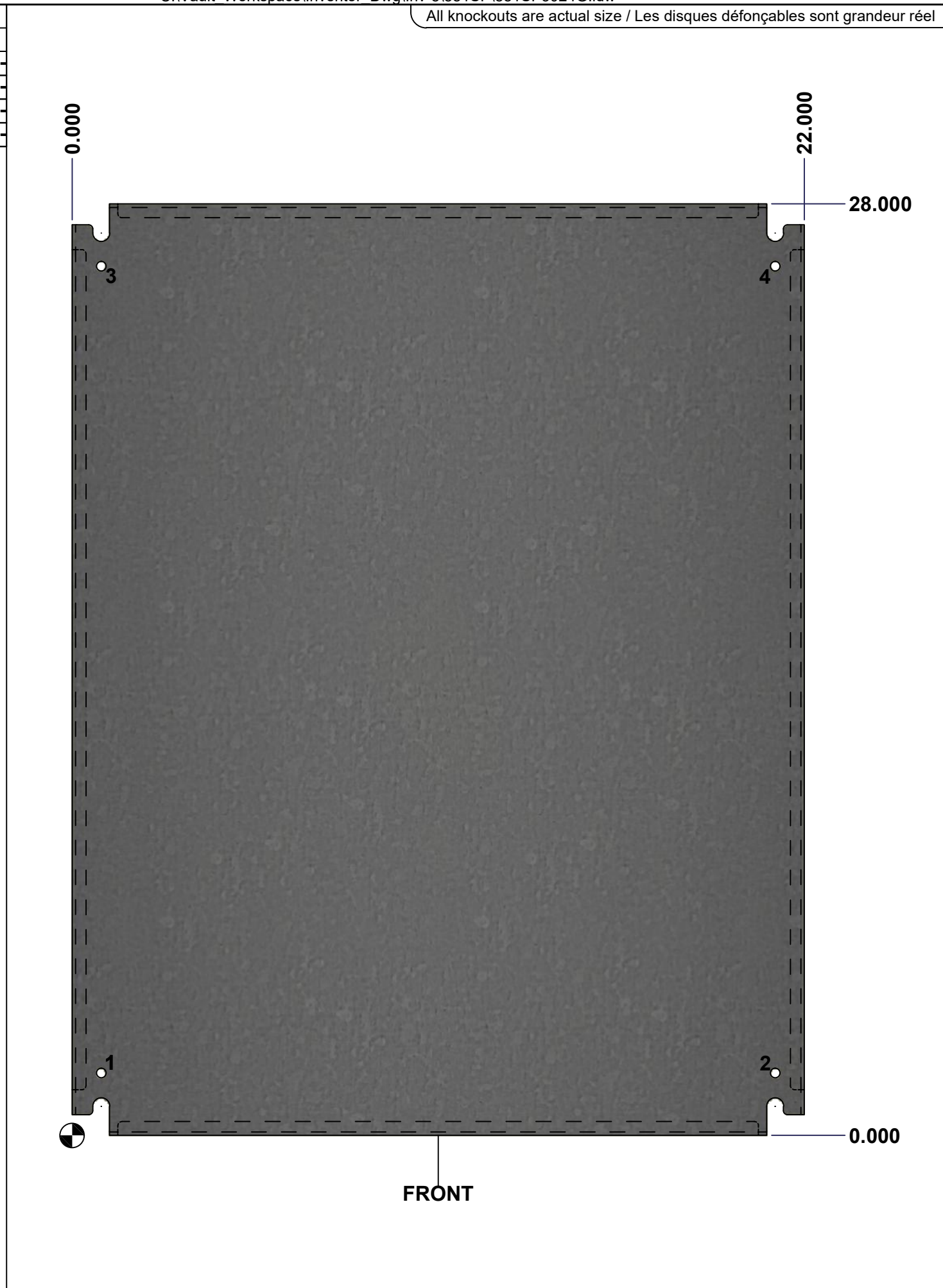

All knockouts are actual size / Les disques défonçables sont grandeur réel

No.	Revisions	Date	By/Par

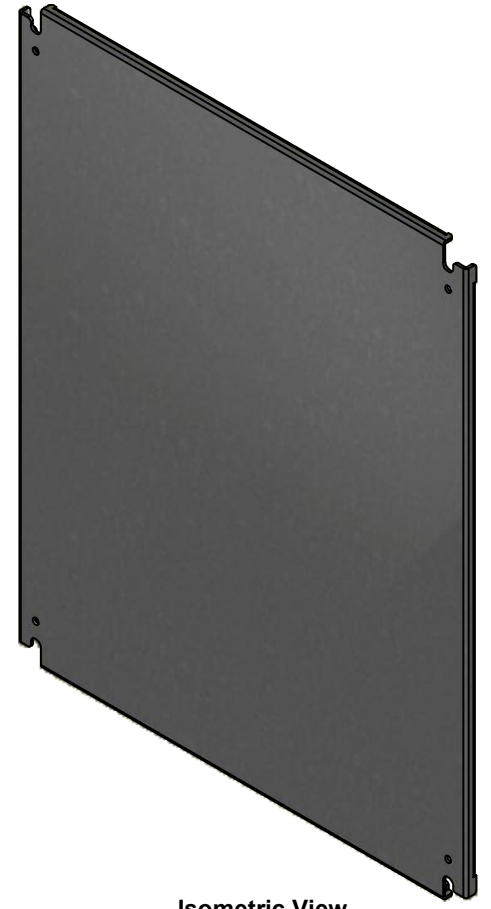

Isometric View



	Tél: (450) 979-4373 Fax: (450) 979-4626 www.exmweb.com	Flatness Aplatissement Max 3.0mm
		Projection
Customer Client		Date
Drawn By Dessiné Par	BoxCad	Date 1/23/2007
Material Matière	See Part List	
Color Couleur	See Part List	Finish Fini See Part List
Description 881 SP - Inner Panel		Detail Rev.
Part Number Numéro Pièce	881 SP3024G	Rev. 2 0