

This drawing is confidential and must not be reproduced or used without the consent of EXM

Ce dessin est confidentiel et ne doit pas être reproduit ou utilisé sans le consentement de EXM



TOP



BACK

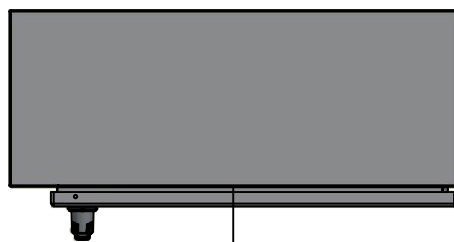

BOTTOM

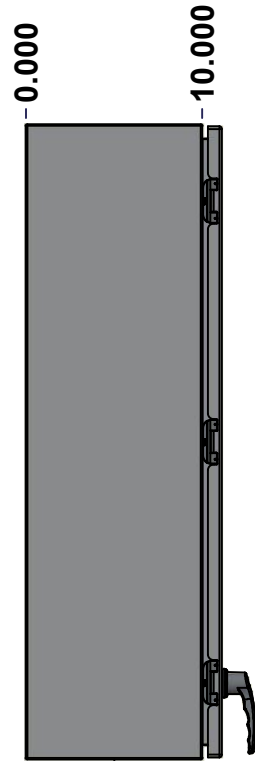

LEFT

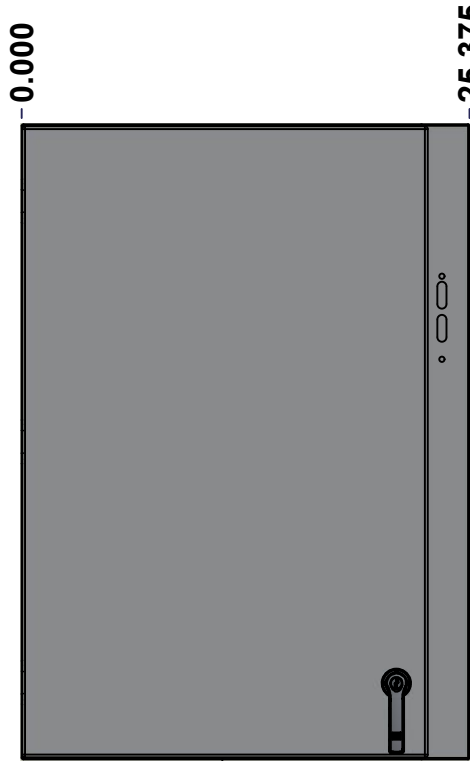

FRONT

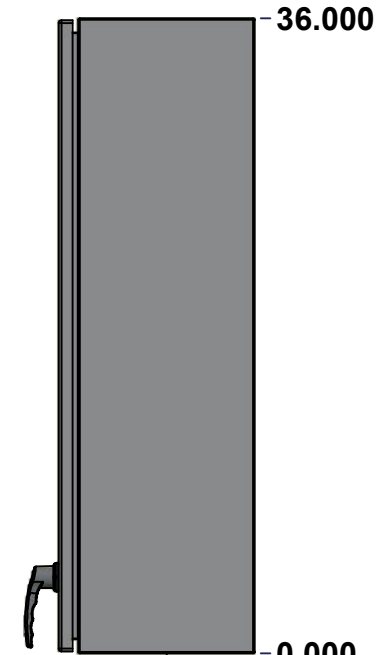

RIGHT

| No. | Revisions | Date | By/Par |
|-----|-----------|------|--------|
|     |           |      |        |
|     |           |      |        |
|     |           |      |        |
|     |           |      |        |
|     |           |      |        |

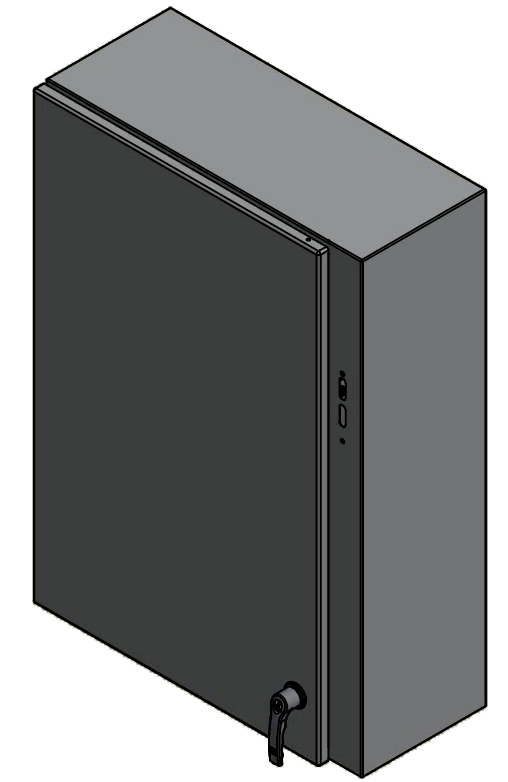

Isometric View



Tél: (450) 979-4373  
 Fax: (450) 979-4626  
[www.exmweb.com](http://www.exmweb.com)

Flatness  
Aplatissement  
Max 3.0mm  
Projection

|   |                  |
|---|------------------|
| Customer Client   | Date             |
| Drawn By / Dessiné Par: BoxCad: BoxCad                        | Date: 10/23/2014 |
| Material / Matière: 16 Ga Cold Rolled A1008 CS Type B (1.4mm) |                  |

|                              |                       |
|------------------------------|-----------------------|
| Color / Couleur: Asa-61 Grey | Finish / Fini: Smooth |
|------------------------------|-----------------------|

|   |             |
|---|-------------|
| Description: 5500ESY 36" x 25.375" x 10" Assembly | Detail Rev. |
|---|-------------|

|   |        |   |   |
|---|--------|---|---|
| Part Number / Numéro Pièce: 5500ESY362510 | Rev. 0 | 1 | 9 |
|---|--------|---|---|

SEE BILL OF MATERIAL ON LAST PAGE

This drawing is confidential and must not be reproduced or used without the consent of EXM

Ce dessin est confidentiel et ne doit pas être reproduit ou utilisé sans le consentement de EXM

| NOTE |  |
|------|--|
| ITEM | DESCRIPTION                                |
| 1    | NEMA 12/13 Enclosure                       |
| 2    | C/W Standard ground studs on box and cover |
| 3    | C/W Standard door stiffener                |
| 4    | C/W Standard inner panel (Included)        |
| 5    | C/W Standard inner panel mounting studs    |
| 6    | C/W 880 PP included (Not installed)        |

| No. | Revisions | Date | By/Par |
|-----|-----------|------|--------|
|     |           |      |        |
|     |           |      |        |
|     |           |      |        |
|     |           |      |        |
|     |           |      |        |
|     |           |      |        |

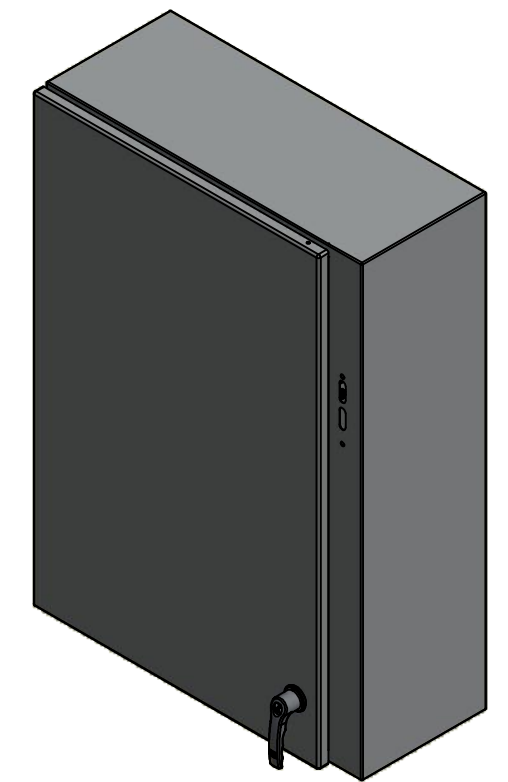

Isometric View

 Tél: (450) 979-4373  
 Fax: (450) 979-4626  
[www.exmweb.com](http://www.exmweb.com)

Flatness  
 Aplatissement  
 Max 3.0mm  
 Projection  

|  |                 |
|--|-----------------|
| Customer Client                        | Date            |
| Drawn By<br>Dessiné Par BoxCad: BoxCad | Date 10/23/2014 |

Material Matière 16 Ga Cold Rolled A1008 CS Type B (1.4mm)

|               |             |             |        |
|---------------|-------------|-------------|--------|
| Color Couleur | Asa-61 Grey | Finish Fini | Smooth |
|---------------|-------------|-------------|--------|

Description 5500ESY 36" x 25.375" x 10" Assembly

|                             |          |          |
|-----------------------------|----------|----------|
| Part Number<br>Numéro Pièce | Rev.     | 2        |
| <b>5500ESY362510</b>        | <b>0</b> | <b>9</b> |

| Qty        | Part Number    | Rev | Description  |
|------------|----------------|-----|--|
| 1          | 880 PP         | 6   | Self Adhesive Print Pocket                             |
| 1          | STK-K-01800    | 5   | 5412 ES Accessory Kit                                  |
| 1          | 5500ESY362510C | 0   | 5500ESY 36" x 25.375" Cover                            |
| 6          | STK-Q-07310    | 2   | Flange Lock Nut M8                                     |
| 1          | 881 SP3624G    | 0   | 881 SP - Inner Panel                                   |
| 6          | STK-Q-07610    | 8   | M8 Plastic Spacer 22.2mm                               |
| 1          | 5500ESY362510B | 0   | 5500ESY 36" x 25.375" x 10" Body                       |
| 3          | STK-Q-04050-07 | 7   | M6 x 7mm Hexagon Socket Head Machine Screw with Nyseal |
| Parts List |                |     |  |

| PACKING               |     |  |
|-----------------------|-----|--|
| ITEM                  | QTY | DESCRIPTION                                |
| Cardboard sleeve      | 2   | Top and Bottom                             |
| Cardboard strip       | 2   | Between back of enclosure and inner panel  |
| Plastic bag           | 1   | To protect cover surface and inside gasket |
| Plastic strap - Black | 2   | To Squeeze the 2 cardboard sleeve together |
| Packaging label       | 1   | White label with product number            |

This drawing is confidential and must not be reproduced or used without the consent of EXM

Ce dessin est confidentiel et ne doit pas être reproduit ou utilisé sans le consentement de EXM



TOP



BACK



BOTTOM

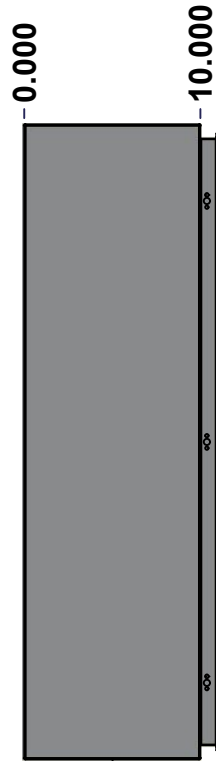

LEFT

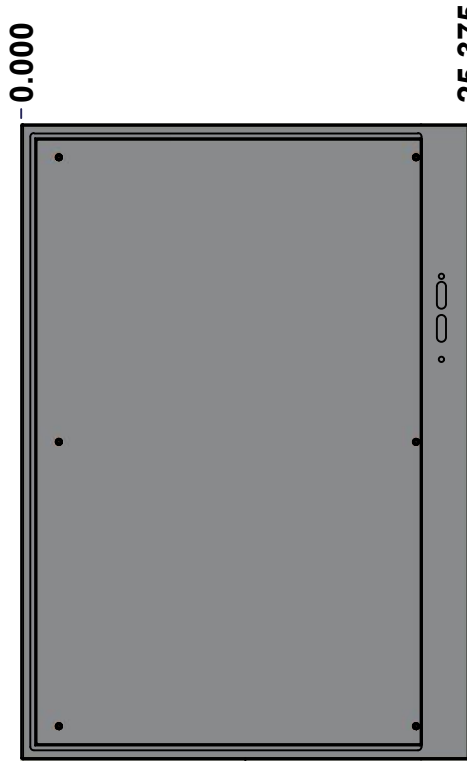

FRONT

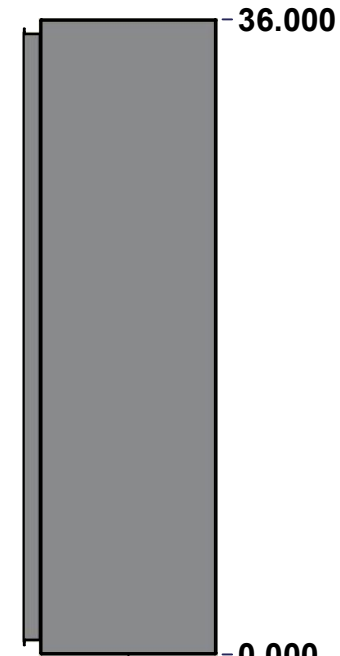

RIGHT

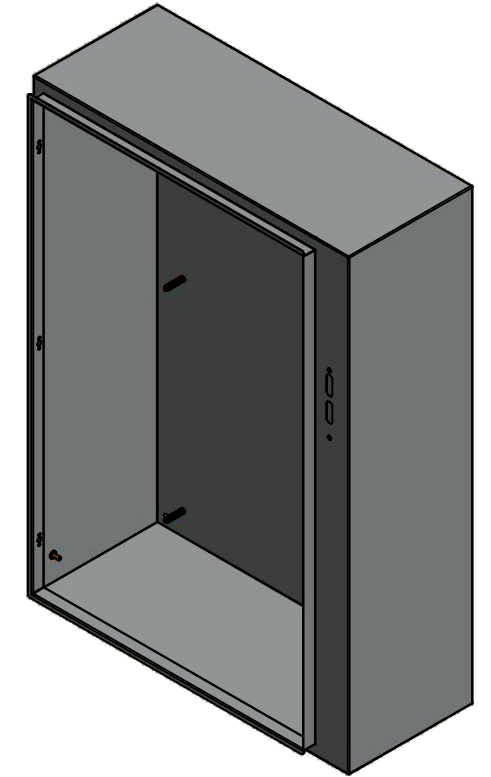

Isometric View



| No. | Revisions | Date | By/Par |
|-----|-----------|------|--------|
|     |           |      |        |
|     |           |      |        |
|     |           |      |        |
|     |           |      |        |
|     |           |      |        |

|  |   |   |
|--|---|---|
|  Tél: (450) 979-4373<br>Fax: (450) 979-4626<br><a href="http://www.exmweb.com">www.exmweb.com</a> |   | Flatness<br>Aplatissement<br>Max 3.0mm<br>Projection<br> |
| Customer Client  | Date                                      |   |
| Drawn By<br>Dessiné Par  | BoxCad: BoxCad                            | Date 10/23/2014   |
| Material<br>Matière  | 16 Ga Cold Rolled A1008 CS Type B (1.4mm) |   |
| Color<br>Couleur   | Asa-61 Grey                               | Finish<br>Fini Smooth   |
| Description  |   | Detail Rev.   |
| 5500ESY 36" x 25.375" x 10" Body   |   |   |
| Part Number<br>Numéro Pièce  | Rev.                                      | 3   |
| 5500ESY362510B   | 0   | 9   |

SEE BILL OF MATERIAL ON LAST PAGE

This drawing is confidential and must not be reproduced or used without the consent of EXM

Ce dessin est confidentiel et ne doit pas être reproduit ou utilisé sans le consentement de EXM

| <b>STANDARD FEATURES ARE NOT LISTED IN THIS HOLE TABLE</b> |       |       |                             |
|--|-------|-------|-----------------------------|
| <b>HOLE TABLE - LEFT VIEW (CUSTOM FEATURE ONLY)</b>        |       |       |                             |
| CUT-OUT  | XDIM  | YDIM  | DESCRIPTION                 |
| 1  | 8.500 | 2.000 | GND STUD M6 x 16mm (Inside) |

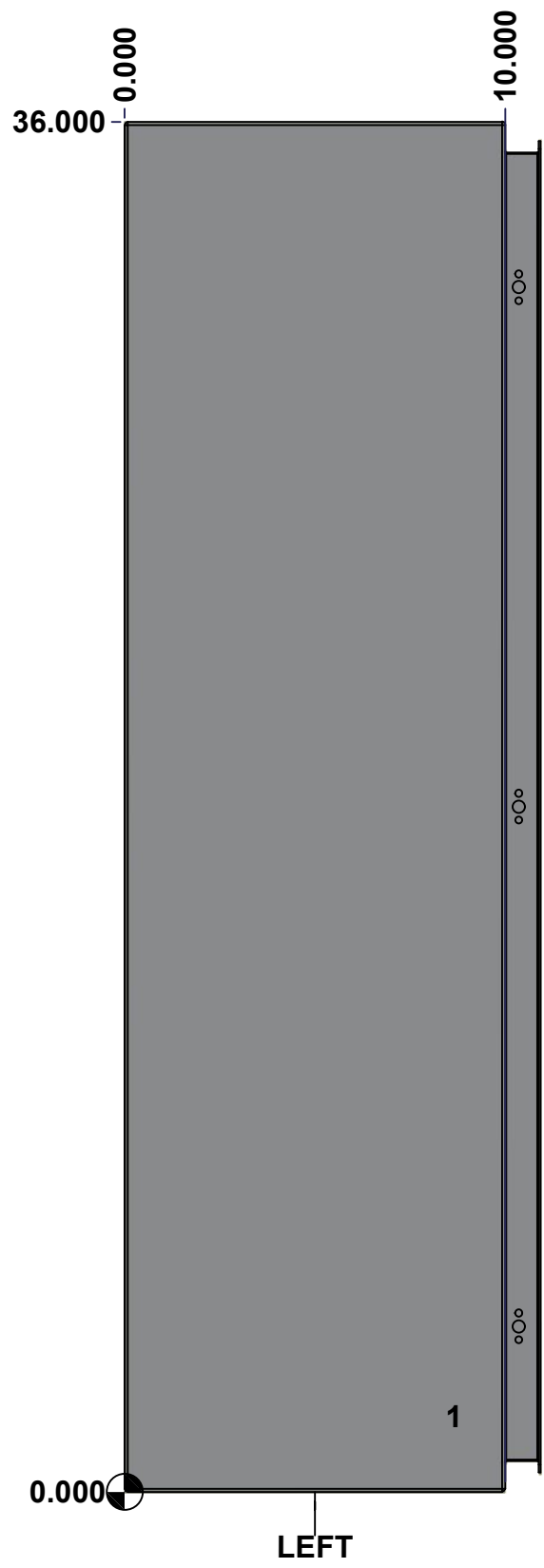

|  |                                  |          |        |
|--|----------------------------------|----------|--------|
|  | Description                      | Status   |        |
|  | 5500ESY 36" x 25.375" x 10" Body | (NULL)   |        |
|  | Part Number<br>Numéro Pièce      | Rev.     |        |
|  | <b>5500ESY362510B</b>            | <b>0</b> | 4<br>9 |

This drawing is confidential and must not be reproduced or used without the consent of EXM

Ce dessin est confidentiel et ne doit pas être reproduit ou utilisé sans le consentement de EXM

**STANDARD FEATURES ARE NOT LISTED IN THIS HOLE TABLE**

**HOLE TABLE - BACK VIEW (CUSTOM FEATURE ONLY)**

| CUT-OUT | XDIM   | YDIM   | DESCRIPTION                |
|---------|--------|--------|----------------------------|
| 1       | 3.000  | 1.875  | IP STUD M8 x 35mm (Inside) |
| 2       | 3.000  | 34.125 | IP STUD M8 x 35mm (Inside) |
| 3       | 23.250 | 34.125 | IP STUD M8 x 35mm (Inside) |
| 4       | 23.250 | 1.875  | IP STUD M8 x 35mm (Inside) |
| 5       | 3.000  | 18.000 | IP STUD M8 x 35mm (Inside) |
| 6       | 23.250 | 18.000 | IP STUD M8 x 35mm (Inside) |
| -----   |        |        |                            |
| 7       | 0.750  | 35.250 | RND Ø0.390                 |
| 8       | 24.625 | 0.750  | RND Ø0.390                 |
| 9       | 24.625 | 35.250 | RND Ø0.390                 |
| 10      | 0.750  | 0.750  | RND Ø0.390                 |

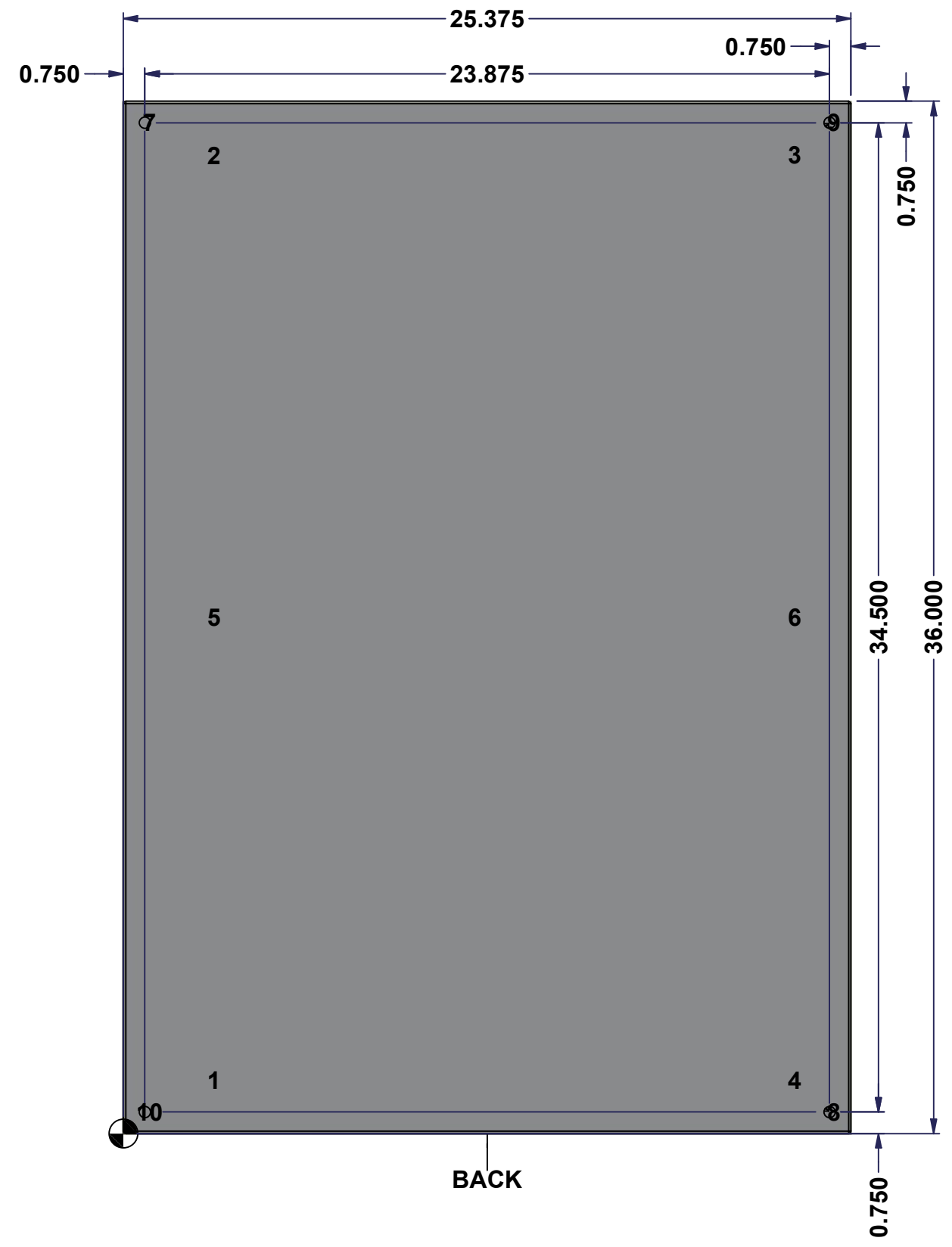

|  |                                  |          |   |
|--|----------------------------------|----------|---|
|  | Description                      | Status   |   |
|  | 5500ESY 36" x 25.375" x 10" Body | (NULL)   |   |
|  | Part Number<br>Numéro Pièce      | Rev.     | 5 |
|  | <b>5500ESY362510B</b>            | <b>0</b> | 9 |

This drawing is confidential and must not be reproduced or used without the consent of EXM

Ce dessin est confidentiel et ne doit pas être reproduit ou utilisé sans le consentement de EXM

| No. | Revisions | Date | By/Par |
|-----|-----------|------|--------|
|     |           |      |        |
|     |           |      |        |
|     |           |      |        |
|     |           |      |        |
|     |           |      |        |

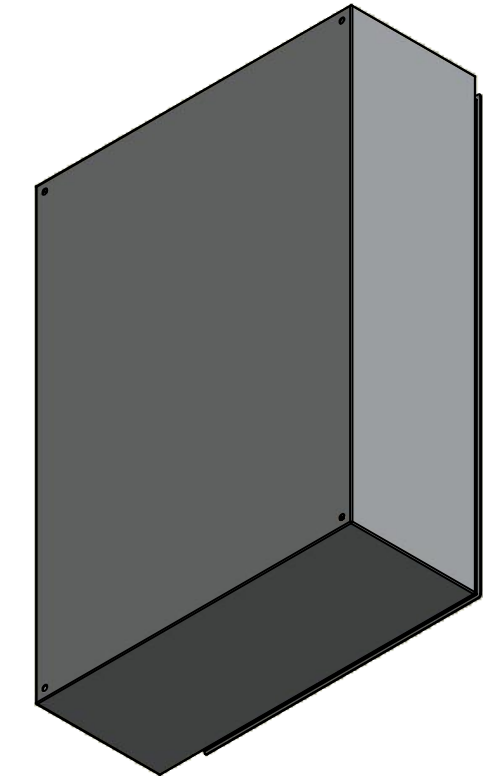

Isometric View

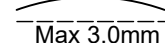

|  |                       |  |
|--|-----------------------|--|
|  Tél: (450) 979-4373<br>Fax: (450) 979-4626<br><a href="http://www.exmweb.com">www.exmweb.com</a> |                       | Flatness<br>Aplatissement<br> Max 3.0mm |
| Customer<br>Client   |                       | Date   |
| Drawn By<br>Dessiné Par BoxCad: BoxCad   |                       | Date 10/23/2014  |
| Material<br>Matière 16 Ga Cold Rolled A1008 CS Type B (1.4mm)  |                       |  |
| Color<br>Couleur Asa-61 Grey   | Finish<br>Fini Smooth |  |
| Description<br>5500ESY 36" x 25.375" x 10" Body  |                       | Detail Rev.  |
| Part Number<br>Numéro Pièce <b>5500ESY362510B</b>  |                       | Rev. <b>0</b>  |

| Qty        | Part Number      | Rev | Description                           |
|------------|------------------|-----|---------------------------------------|
| 1          | STK-Q-16080      | 0   | Ground Stud M6 x 16mm                 |
| 1          | STK-P-02400S     | 0   | Powder Paint (Asa-61 Grey / Smooth)   |
| 6          | STK-Q-16005      | 1   | Stud M8 x 35 (No Paint Cap Required)  |
| 1          | 5500ESY362510B-P | 0   | 5500ESY 36" x 25.375" x 10" Body Part |
| Parts List |                  |     |                                       |

|   |
|---|
| 6 |
| 9 |

This drawing is confidential and must not be reproduced or used without the consent of EXM

Ce dessin est confidentiel et ne doit pas être reproduit ou utilisé sans le consentement de EXM

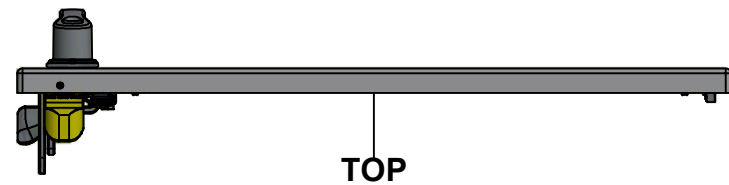

TOP

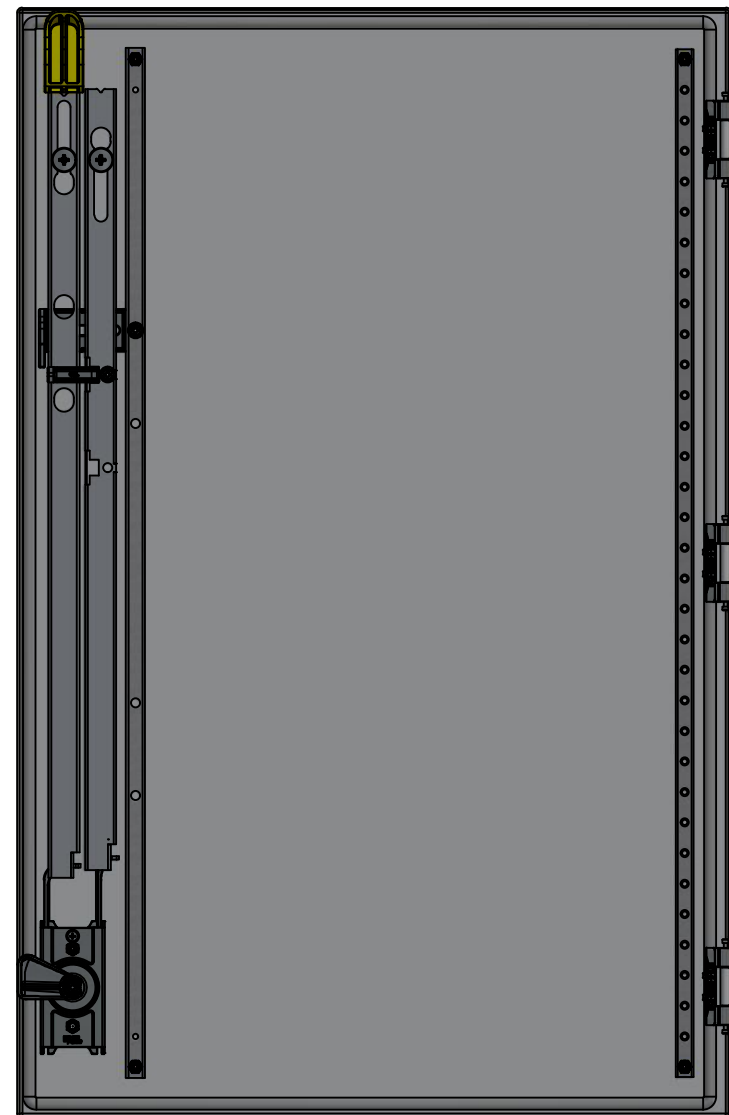

BACK

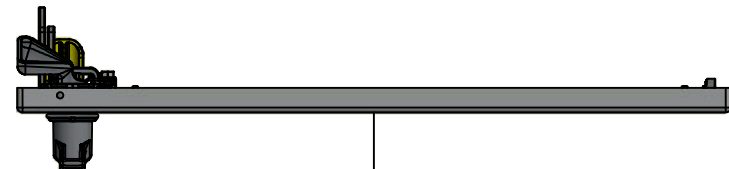

BOTTOM

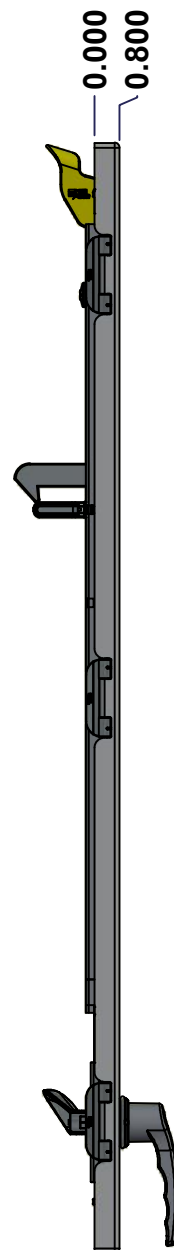

LEFT

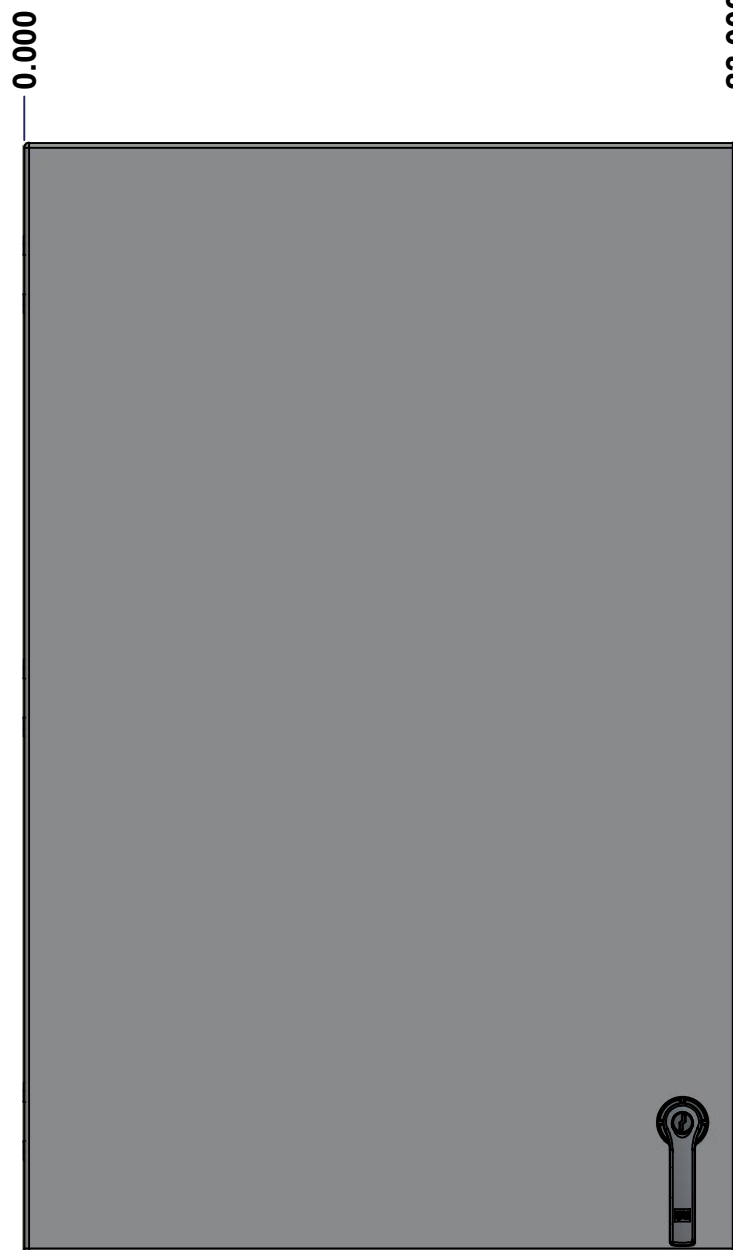

FRONT

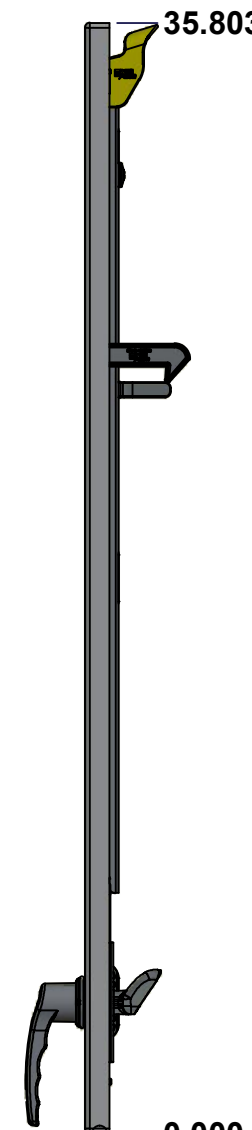

RIGHT

| No. | Revisions | Date | By/Par |
|-----|-----------|------|--------|
|     |           |      |        |
|     |           |      |        |
|     |           |      |        |
|     |           |      |        |
|     |           |      |        |

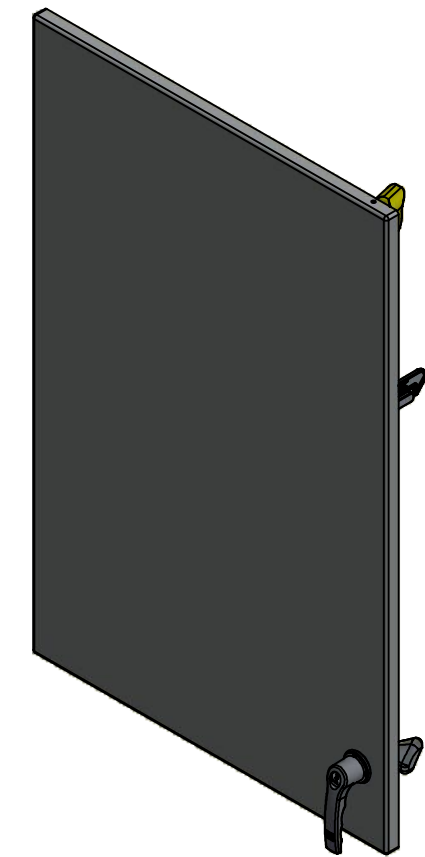

Isometric View

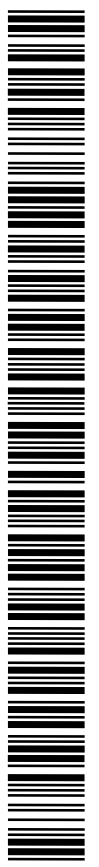

Tél: (450) 979-4373  
 Fax: (450) 979-4626  
[www.exmweb.com](http://www.exmweb.com)

Flatness  
Aplatissement  
Max 3.0mm  
Projection

|   |                       |
|---|-----------------------|
| Customer Client   | Date                  |
| Drawn By<br>Dessiné Par BoxCad: BoxCad                        | Date 10/23/2014       |
| Material<br>Matière 14 Ga Cold Rolled A1008 CS Type B (1.7mm) |                       |
| Color<br>Couleur Asa-61 Grey                                  | Finish<br>Fini Smooth |
| Description<br>5500ESY 36" x 25.375" Cover                    | Detail Rev.           |
| Part Number<br>Numéro Pièce <b>5500ESY362510C</b>             | Rev. 7<br><b>0</b>    |

SEE BILL OF MATERIAL ON LAST PAGE

This drawing is confidential and must not be reproduced or used without the consent of EXM

Ce dessin est confidentiel et ne doit pas être reproduit ou utilisé sans le consentement de EXM

**STANDARD FEATURES ARE NOT LISTED IN THIS HOLE TABLE**

**HOLE TABLE - FRONT VIEW (CUSTOM FEATURE ONLY)**

| CUT-OUT | XDIM   | YDIM   | DESCRIPTION             |
|---------|--------|--------|-------------------------|
| 1       | 1.486  | 1.661  | STUD M6 x 18mm (Inside) |
| 2       | 1.486  | 34.142 | STUD M6 x 18mm (Inside) |
| 3       | 19.194 | 34.142 | STUD M6 x 18mm (Inside) |
| 4       | 19.194 | 1.661  | STUD M6 x 18mm (Inside) |
| 5       | 21.496 | 25.401 | STUD M6 x 18mm (Inside) |
| 6       | 21.496 | 22.401 | STUD M6 x 18mm (Inside) |
| 7       | 21.496 | 30.896 | STUD M6 x 18mm (Inside) |
| 8       | 20.311 | 30.896 | STUD M6 x 18mm (Inside) |
| 9       | 21.219 | 2.969  | STUD M6 x 18mm (Inside) |
| 10      | 21.219 | 5.469  | STUD M6 x 18mm (Inside) |
| -----   | -----  | -----  | -----                   |
| 11      | 21.219 | 4.219  | HANDLE 885 ESL2A @ 0.0° |

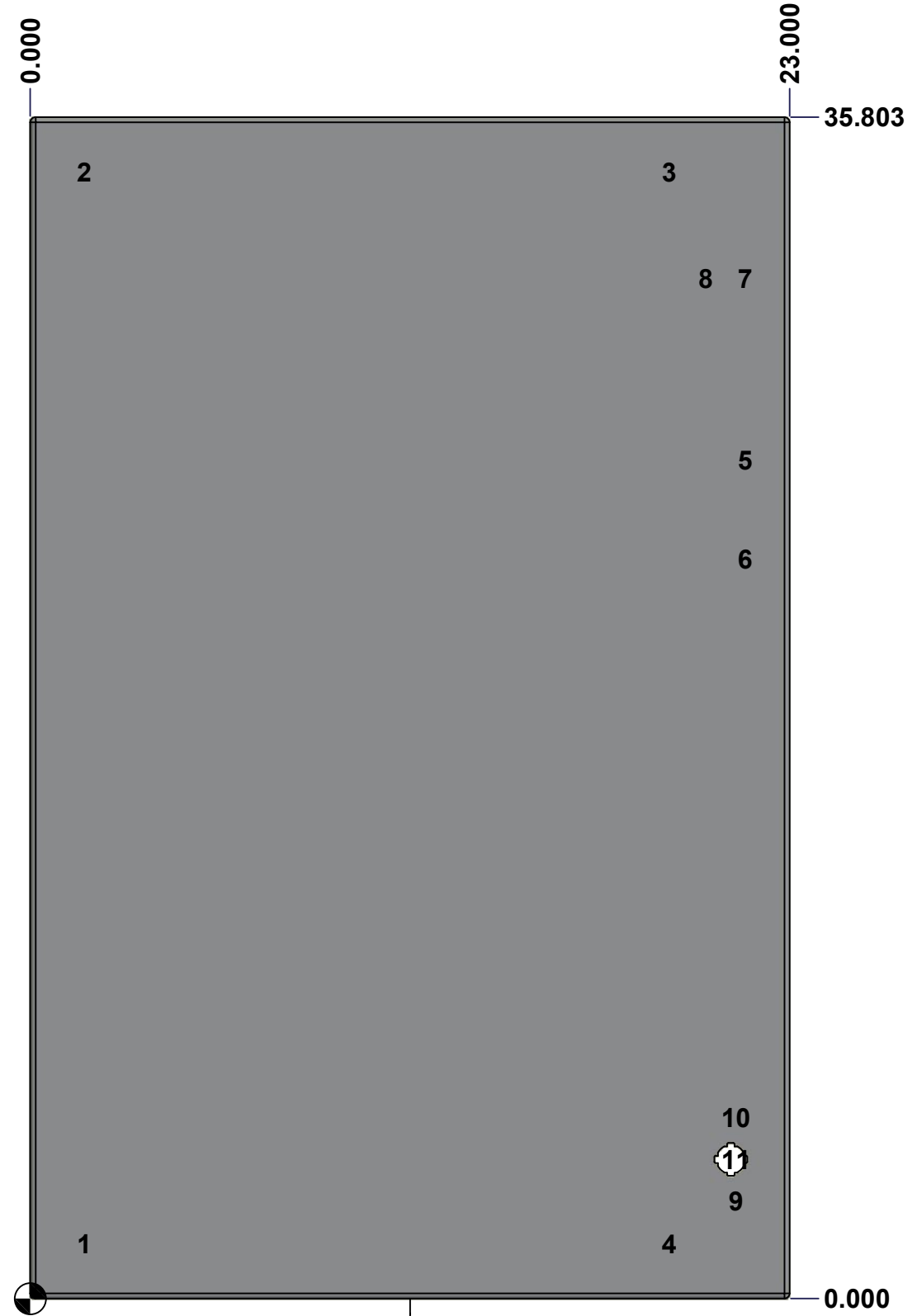

FRONT

|  |                             |                  |
|--|-----------------------------|------------------|
|  | Description                 | Status           |
|  | 5500ESY 36" x 25.375" Cover | (NULL)           |
|  | Part Number<br>Numéro Pièce | Rev.             |
|  | <b>5500ESY362510C</b>       | <b>0</b> / 8 / 9 |



This drawing is confidential and must not be reproduced or used without the consent of EXM

Ce dessin est confidentiel et ne doit pas être reproduit ou utilisé sans le consentement de EXM

| No. | Revisions | Date | By/Par |
|-----|-----------|------|--------|
|     |           |      |        |
|     |           |      |        |
|     |           |      |        |
|     |           |      |        |
|     |           |      |        |

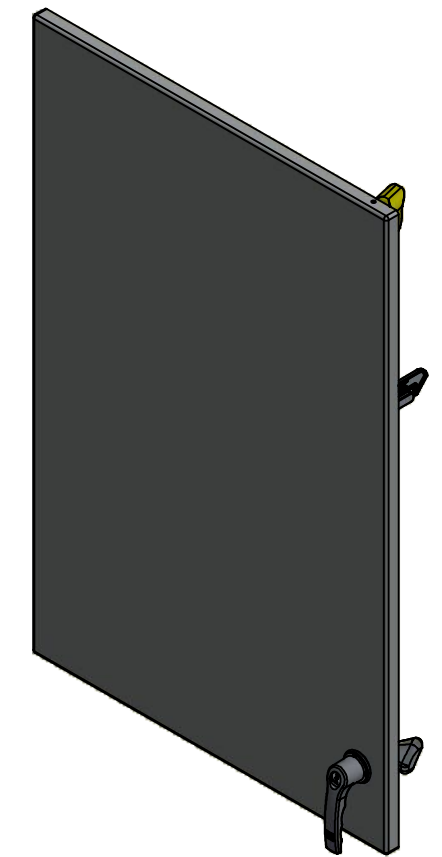

Isometric View



|    |                      |    |   |
|----|----------------------|----|---|
| 1  | STK-A-881DBAR_ESY-36 | 3  | 5500 ESY Defeater Bar 36"               |
| 1  | STK-A-881CBAR_ESY-36 | 4  | 5500 ESY Closing Bar 36"                |
| 1  | STK-K-03890-32       | 3  | Gearbox Clockwise Assembly (Grip 32mm)  |
| 1  | 885 ESL2A            | 4  | 5412 ES Key Lock L-Handle (3 Pts)       |
| 1  | STK-P-02400S         | 0  | Powder Paint (Asa-61 Grey / Smooth)     |
| 1  | STK-Q-03200          | 0  | M6 x 8mm Hexagon/Slot Screw             |
| 1  | STK-Q-13060          | 1  | M6 Flat Washer                          |
| 1  | STK-Q-46600          | 3  | 5500 ESY Disconnect Door Hook           |
| 1  | STK-Q-46021-36       | 2  | 5500 ESY Vertical Door Stiffener 36"    |
| 1  | STK-Q-46020-36       | 5  | 5412 ES Vertical Door Stiffener 36"     |
| 10 | STK-Q-16055          | 1  | M6 x 18mm Stud (No Paint Cap Required)  |
| 1  | 5500ESY362510G       | 0  | 5500ESY 36" x 25.375" Cover Gasket      |
| 1  | 5500ESY362510C-P     | 0  | 5500ESY 36" x 25.375" Cover Part        |
| 3  | STK-K-09800          | 10 | 5412 ES Hinge with 2 Captive Hinge Pins |
| 5  | STK-Q-07220          | 1  | M6 Nylon Insert Lock Nut                |

| Qty        | Part Name | Rev | Description |
|------------|-----------|-----|-------------|
| Parts List |           |     |             |

|  |   |                       |
|--|---|-----------------------|
| Tél: (450) 979-4373<br>Fax: (450) 979-4626<br><a href="http://www.exmweb.com">www.exmweb.com</a> | Flatness<br>Aplatissement                 | Max 3.0mm             |
|  | Projection                                |                       |
| Customer<br>Client   | Date                                      |                       |
| Drawn By<br>Dessiné Par  | BoxCad: BoxCad                            | Date 10/23/2014       |
| Material<br>Matière  | 14 Ga Cold Rolled A1008 CS Type B (1.7mm) |                       |
| Color<br>Couleur   | Asa-61 Grey                               | Finish<br>Fini Smooth |
| Description  | Detail Rev.                               |                       |
| 5500ESY 36" x 25.375" Cover  |   |                       |
| Part Number<br>Numéro Pièce  | Rev.                                      | 9                     |
| <b>5500ESY362510C</b>  | <b>0</b>                                  | <b>9</b>              |

This drawing is confidential and must not be reproduced or used without the consent of EXM

Ce dessin est confidentiel et ne doit pas être reproduit ou utilisé sans le consentement de EXM

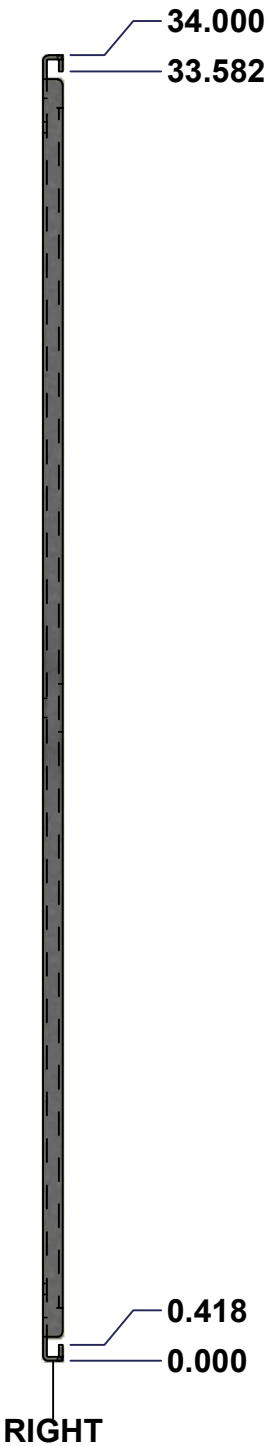
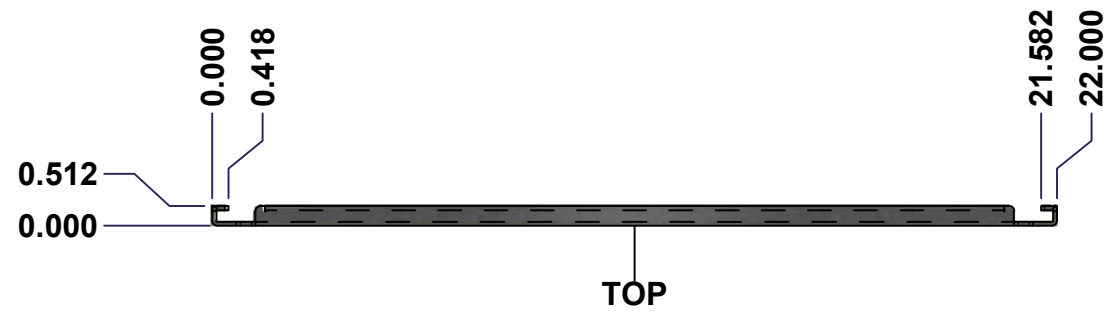

| No. | Revisions | Date | By/Par |
|-----|-----------|------|--------|
|     |           |      |        |
|     |           |      |        |
|     |           |      |        |
|     |           |      |        |
|     |           |      |        |



|  |                           |                              |
|--|---------------------------|------------------------------|
| Tél: (450) 979-4373<br>Fax: (450) 979-4626<br>www.exmweb.com | Flatness<br>Aplatissement | Max 3.0mm                    |
|  | Projection                |                              |
| Customer<br>Client   | Date                      |                              |
| Drawn By<br>Dessiné Par                                      | BoxCad                    | Date 1/23/2007               |
| Material<br>Matière  | See Part List             |                              |
| Color<br>Couleur   | See Part List             | Finish<br>Fini See Part List |
| Description  | Detail Rev.               |                              |
| 881 SP - Inner Panel   |                           |                              |
| Part Number<br>Numéro Pièce                                  | Rev. 0                    | 1<br>2                       |
| <b>881 SP3624G</b>   |                           |                              |

| Qty | Part Number   | Rev | Description               | Material         | Color     | Finish     |
|-----|---------------|-----|---------------------------|------------------|-----------|------------|
| 1   | 881 SP3624G-P | 0   | 881 SP - Inner Panel Part | 12 Ga Galvanized | Unpainted | Galvanized |

Parts List

This drawing is confidential and must not be reproduced or used without the consent of EXM

Ce dessin est confidentiel et ne doit pas être reproduit ou utilisé sans le consentement de EXM

| Table 1 |        |        | FRONT VIEW                 |
|---------|--------|--------|----------------------------|
| CUT-OUT | XDIM   | YDIM   | DESCRIPTION                |
| 1       | 0.875  | 1.875  | GROUND HOLE (RND Ø0.290)   |
| 2       | 21.125 | 1.875  | GROUND HOLE (RND Ø0.290)   |
| 3       | 0.875  | 32.125 | GROUND HOLE (RND Ø0.290)   |
| 4       | 21.125 | 32.125 | GROUND HOLE (RND Ø0.290)   |
| 5       | 0.875  | 17.000 | MTG STUD HOLE (RND Ø0.500) |
| 6       | 21.125 | 17.000 | MTG STUD HOLE (RND Ø0.500) |

All knockouts are actual size / Les disques défonçables sont grandeur réel



FRONT

| No. | Revisions | Date | By/Par |
|-----|-----------|------|--------|
|     |           |      |        |
|     |           |      |        |
|     |           |      |        |
|     |           |      |        |
|     |           |      |        |



Isometric View



|                      |  |                |
|----------------------|--|----------------|
|                      | Tél: (450) 979-4373<br>Fax: (450) 979-4626<br>www.exmweb.com | Flatness       |
|                      |  | Aplatissement  |
|                      |  | Max 3.0mm      |
|                      |  | Projection     |
|                      |  |                |
| Customer             |  | Date           |
| Client               |  |                |
| Drawn By             | BoxCad   | Date 1/23/2007 |
| Dessiné Par          |  |                |
| Material             | See Part List  |                |
| Matière              |  |                |
| Color                | See Part List  | Finish         |
| Couleur              |  | Fini           |
|                      |  | See Part List  |
| Description          |  | Detail Rev.    |
| 881 SP - Inner Panel |  |                |
| Part Number          | Rev.   | 2              |
| Numéro Pièce         | 0  | 2              |
| <b>881 SP3624G</b>   |  |                |