

This drawing is confidential and must not be reproduced or used without the consent of EXM

Ce dessin est confidentiel et ne doit pas être reproduit ou utilisé sans le consentement de EXM

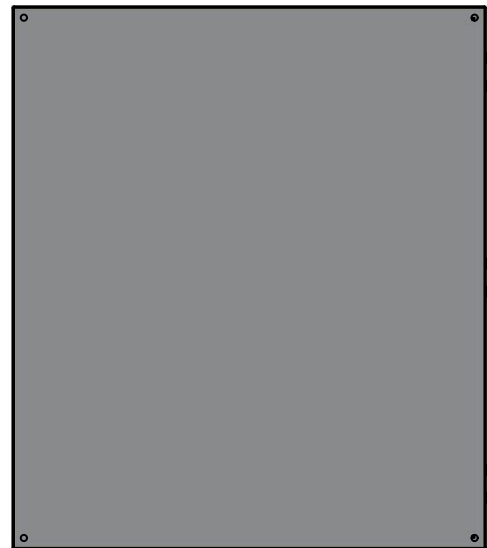

TOP



BACK

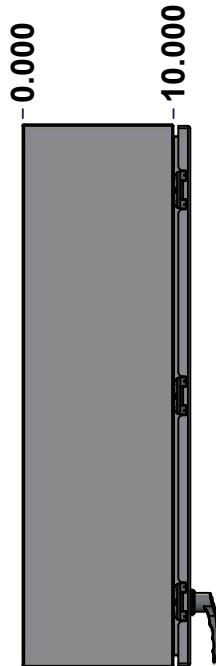

LEFT

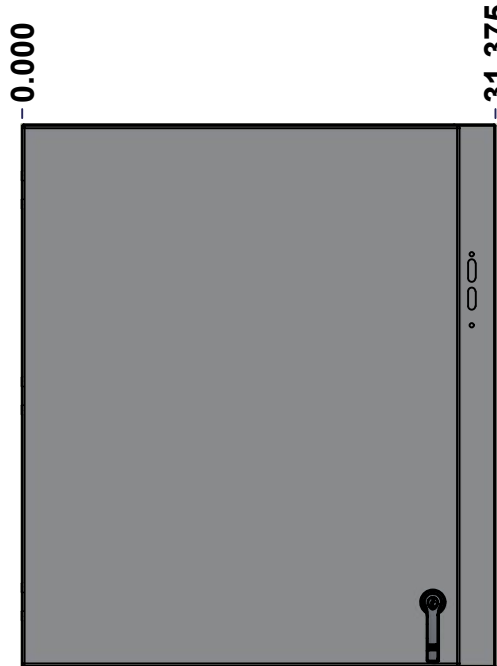

FRONT

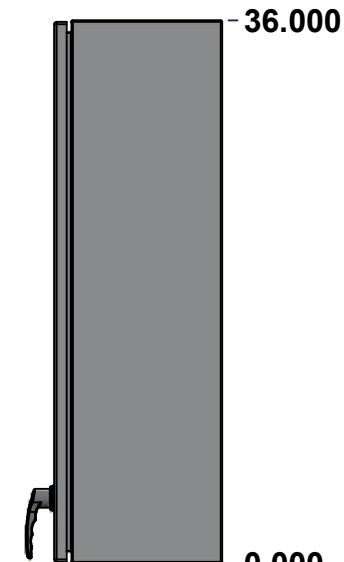

RIGHT

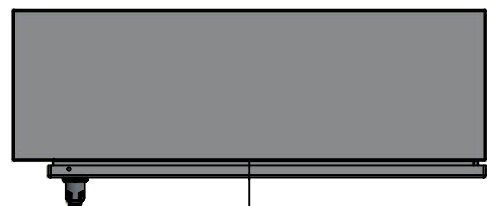

BOTTOM

No.	Revisions	Date	By/Par

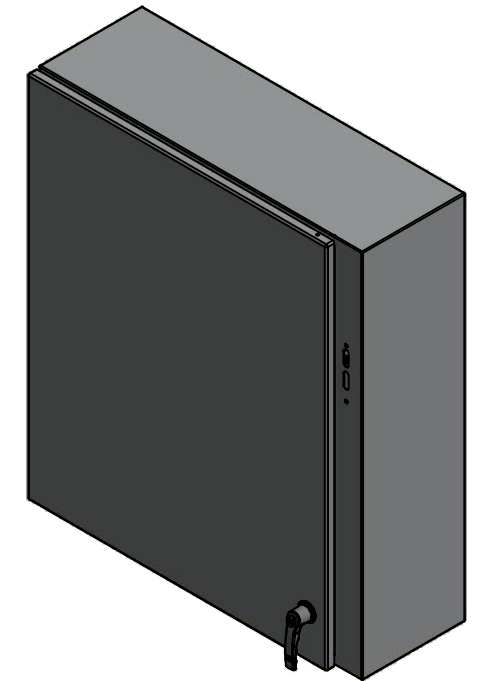

Isometric View



Tél: (450) 979-4373
 Fax: (450) 979-4626
www.exmweb.com

Flatness
Aplatissement

Max 3.0mm

Projection

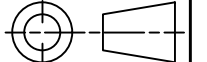

Customer Client	Date
Drawn By / Dessiné Par: BoxCad: BoxCad	Date: 2014-10-23
Material / Matière: 14 Ga Cold Rolled A1008 CS Type B (1.7mm)	
Color / Couleur: Asa-61 Grey	Finish / Fini: Smooth

Description: 5500ESY 36" x 31.375" x 10" Assembly	Detail Rev.
Part Number / Numéro Pièce: 5500ESY363110	Rev. 1

SEE BILL OF MATERIAL ON LAST PAGE

5500ESY363110

Rev. 0	1
	9

This drawing is confidential and must not be reproduced or used without the consent of EXM

Ce dessin est confidentiel et ne doit pas être reproduit ou utilisé sans le consentement de EXM

NOTE	
ITEM	DESCRIPTION
1	NEMA 12/13 Enclosure
2	C/W Standard ground studs on box and cover
3	C/W Standard door stiffener
4	C/W Standard inner panel (Included)
5	C/W Standard inner panel mounting studs
6	C/W 880 PP included (Not installed)

No.	Revisions	Date	By/Par

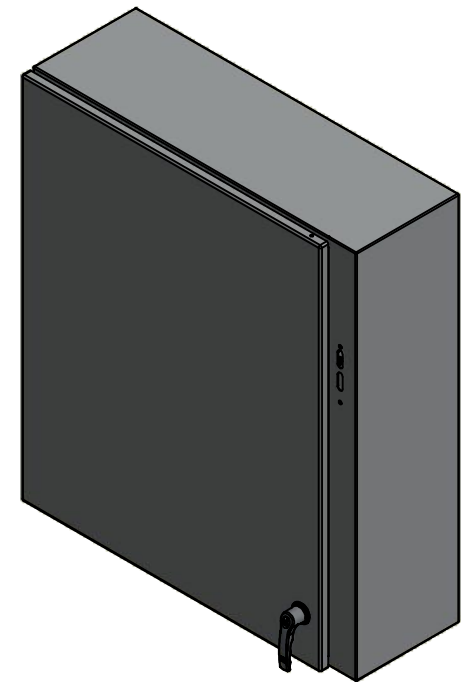

Isometric View



Tél: (450) 979-4373
 Fax: (450) 979-4626
www.exmweb.com

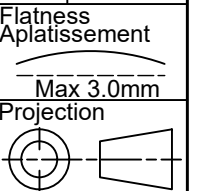

Customer Client	Date
Drawn By / Dessiné Par: BoxCad: BoxCad	Date: 2014-10-23

Material / Matière: 14 Ga Cold Rolled A1008 CS Type B (1.7mm)

Color / Couleur: Asa-61 Grey Finish / Fini: Smooth

Description: 5500ESY 36" x 31.375" x 10" Assembly Detail Rev.

Part Number / Numéro Pièce: **5500ESY363110** Rev. **0** / 2

Qty	Part Number	Rev	Description
1	880 PP	6	Self Adhesive Print Pocket
1	STK-K-01800	5	5412 ES Accessory Kit
1	5500ESY363110C	0	5500ESY 36" x 31.375" Cover
6	STK-Q-07310	2	Flange Lock Nut M8
1	881 SP3630G	0	881 SP - Inner Panel
6	STK-Q-07610	8	M8 Plastic Spacer 22.2mm
1	5500ESY363110B	0	5500ESY 36" x 31.375" x 10" Body
3	STK-Q-04050-07	7	M6 x 7mm Hexagon Socket Head Machine Screw with Nyseal
Parts List			

PACKING		
ITEM	QTY	DESCRIPTION
Cardboard sleeve	2	Top and Bottom
Cardboard strip	2	Between back of enclosure and inner panel
Plastic bag	1	To protect cover surface and inside gasket
Plastic strap - Black	2	To Squeeze the 2 cardboard sleeve together
Packaging label	1	White label with product number

This drawing is confidential and must not be reproduced or used without the consent of EXM

Ce dessin est confidentiel et ne doit pas être reproduit ou utilisé sans le consentement de EXM



TOP

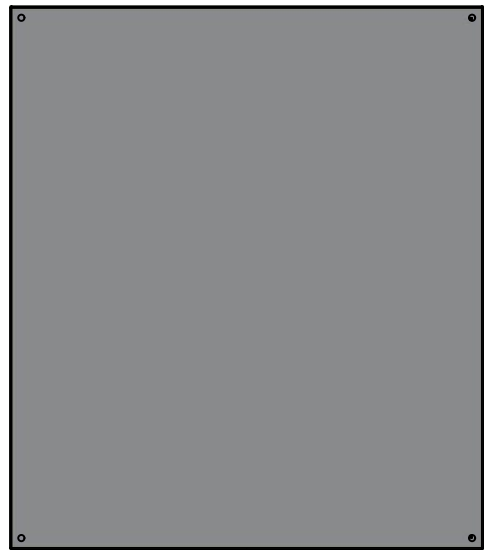

BACK

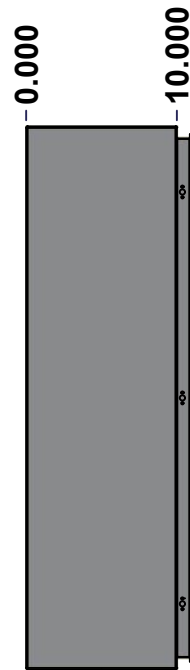

LEFT

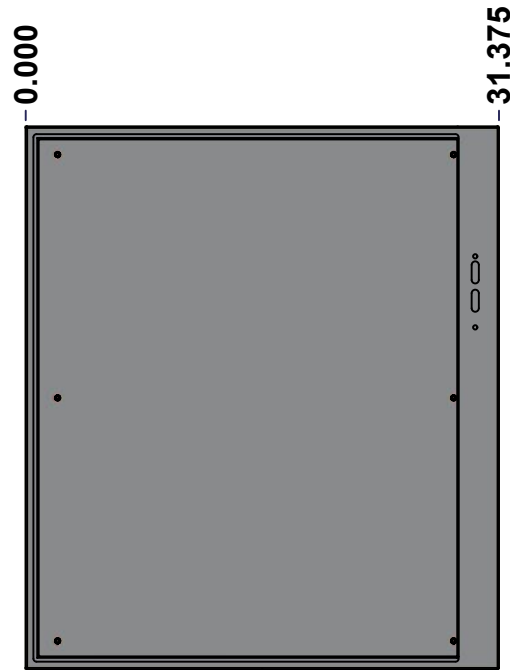

FRONT

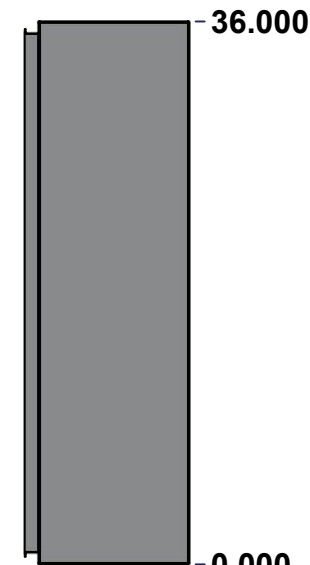

RIGHT



BOTTOM

No.	Revisions	Date	By/Par

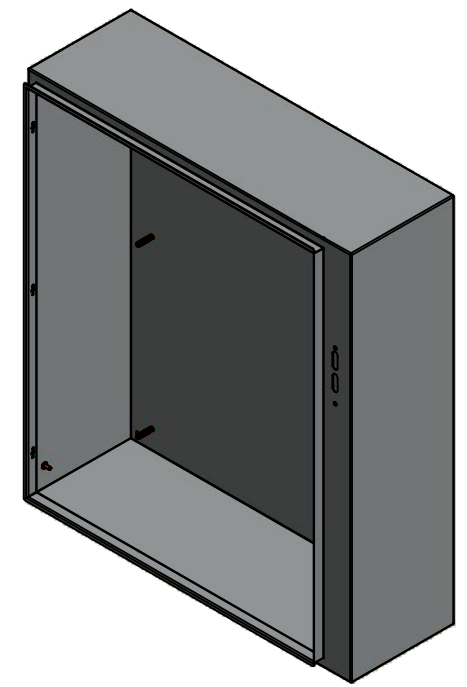

Isometric View



Tél: (450) 979-4373
 Fax: (450) 979-4626
www.exmweb.com

Flatness
Aplatissement

Max 3.0mm

Projection

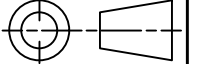

Customer Client	Date
Drawn By / Dessiné Par: BoxCad: BoxCad	Date: 2014-10-23
Material / Matière: 14 Ga Cold Rolled A1008 CS Type B (1.7mm)	
Color / Couleur: Asa-61 Grey	Finish / Fini: Smooth
Description: 5500ESY 36" x 31.375" x 10" Body	Detail Rev.
Part Number / Numéro Pièce: 5500ESY363110B	Rev. 3
SEE BILL OF MATERIAL ON LAST PAGE	0

SEE BILL OF MATERIAL ON LAST PAGE

This drawing is confidential and must not be reproduced or used without the consent of EXM

Ce dessin est confidentiel et ne doit pas être reproduit ou utilisé sans le consentement de EXM

STANDARD FEATURES ARE NOT LISTED IN THIS HOLE TABLE			
HOLE TABLE - LEFT VIEW (CUSTOM FEATURE ONLY)			
CUT-OUT	XDIM	YDIM	DESCRIPTION
1	8.500	2.000	GND STUD M6 x 16mm (Inside)

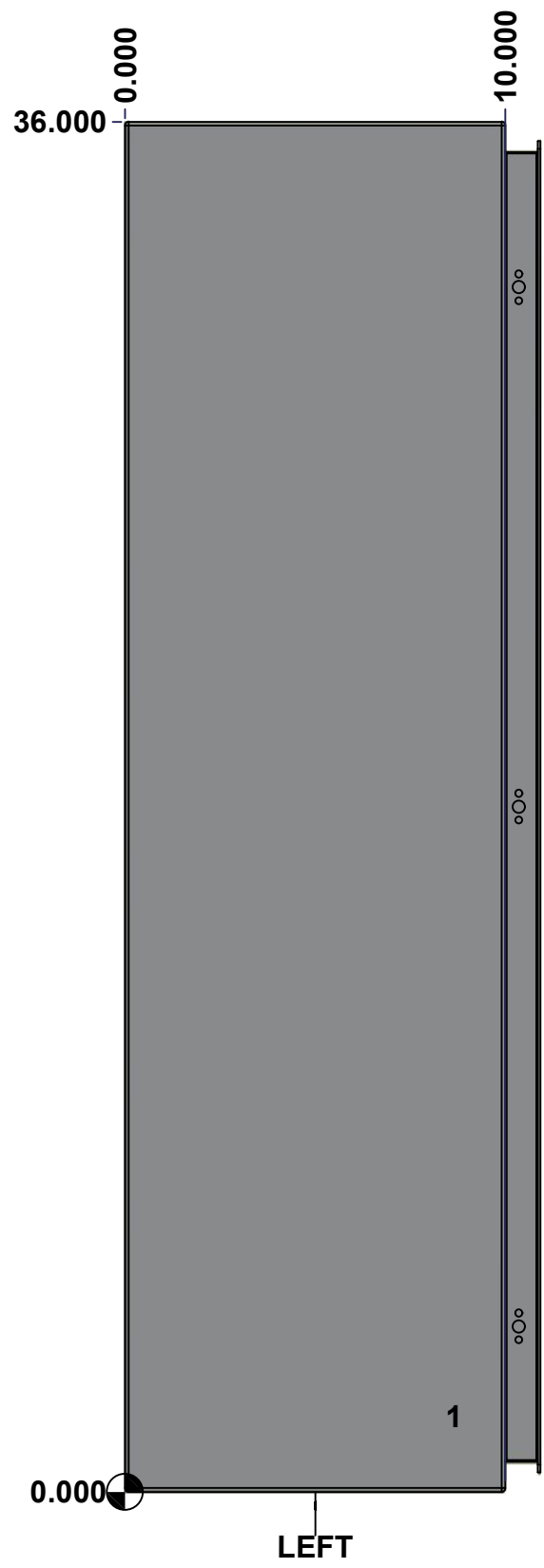

	Description	Status	
	5500ESY 36" x 31.375" x 10" Body	(NULL)	
	Part Number Numéro Pièce	Rev.	
	5500ESY363110B	0	4 9

This drawing is confidential and must not be reproduced or used without the consent of EXM

Ce dessin est confidentiel et ne doit pas être reproduit ou utilisé sans le consentement de EXM

STANDARD FEATURES ARE NOT LISTED IN THIS HOLE TABLE

HOLE TABLE - BACK VIEW (CUSTOM FEATURE ONLY)

CUT-OUT	XDIM	YDIM	DESCRIPTION
1	3.000	1.875	IP STUD M8 x 35mm (Inside)
2	3.000	34.125	IP STUD M8 x 35mm (Inside)
3	29.250	34.125	IP STUD M8 x 35mm (Inside)
4	29.250	1.875	IP STUD M8 x 35mm (Inside)
5	3.000	18.000	IP STUD M8 x 35mm (Inside)
6	29.250	18.000	IP STUD M8 x 35mm (Inside)

7	30.625	0.750	RND Ø0.390
8	30.625	35.250	RND Ø0.390
9	0.750	35.250	RND Ø0.390
10	0.750	0.750	RND Ø0.390

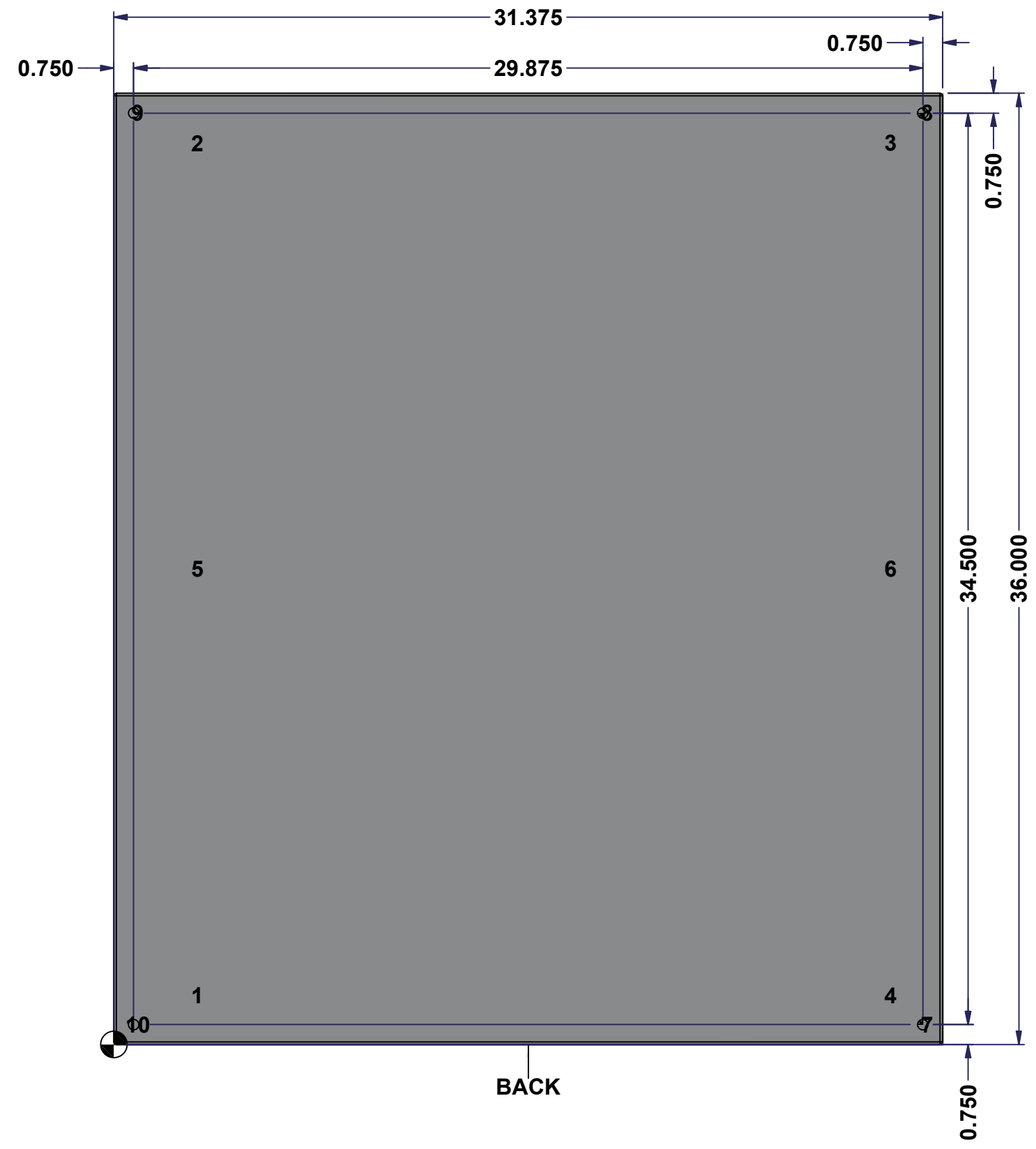

BACK

	Description	Status	
	5500ESY 36" x 31.375" x 10" Body	(NULL)	
	Part Number	Rev.	5
	Numéro Pièce	0	9
		5500ESY363110B	

This drawing is confidential and must not be reproduced or used without the consent of EXM

Ce dessin est confidentiel et ne doit pas être reproduit ou utilisé sans le consentement de EXM

No.	Revisions	Date	By/Par

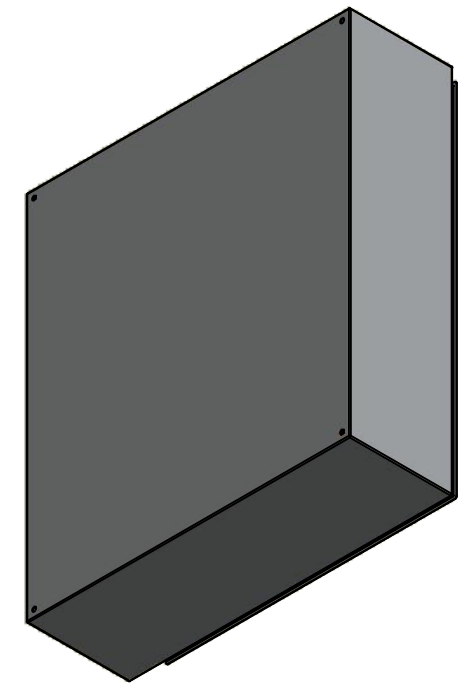

Isometric View

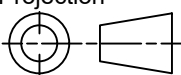

 Tél: (450) 979-4373 Fax: (450) 979-4626 www.exmweb.com		Flatness Aplatissement Max 3.0mm Projection 
Customer Client	Date	
Drawn By Dessiné Par	BoxCad: BoxCad	Date 2014-10-23
Material Matière	14 Ga Cold Rolled A1008 CS Type B (1.7mm)	
Color Couleur	Asa-61 Grey	Finish Fini Smooth
Description		Detail Rev.
5500ESY 36" x 31.375" x 10" Body		
Part Number Numéro Pièce	Rev.	6
5500ESY363110B	0	9

Qty	Part Number	Rev	Description
1	STK-Q-16080	0	Ground Stud M6 x 16mm
1	STK-P-02400S	0	Powder Paint (Asa-61 Grey / Smooth)
6	STK-Q-16005	1	Stud M8 x 35 (No Paint Cap Required)
1	5500ESY363110B-P	0	5500ESY 36" x 31.375" x 10" Body Part
Parts List			

This drawing is confidential and must not be reproduced or used without the consent of EXM

Ce dessin est confidentiel et ne doit pas être reproduit ou utilisé sans le consentement de EXM

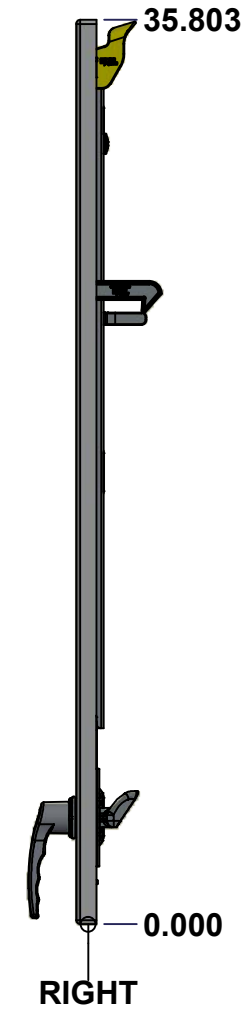
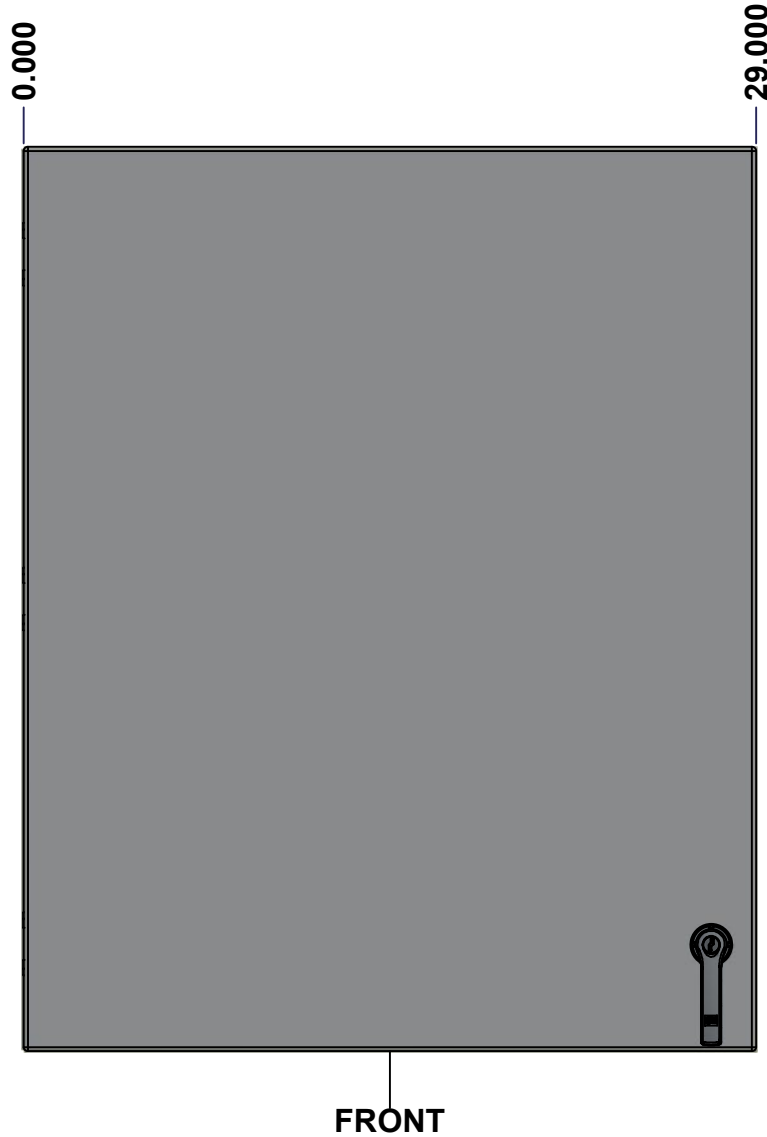
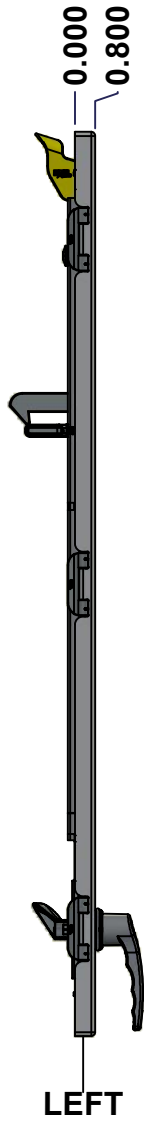
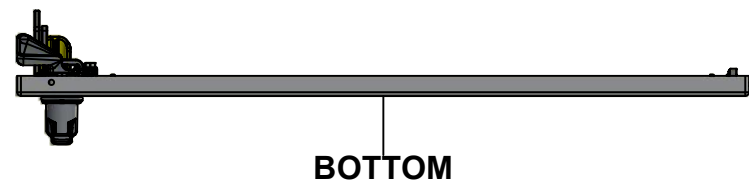
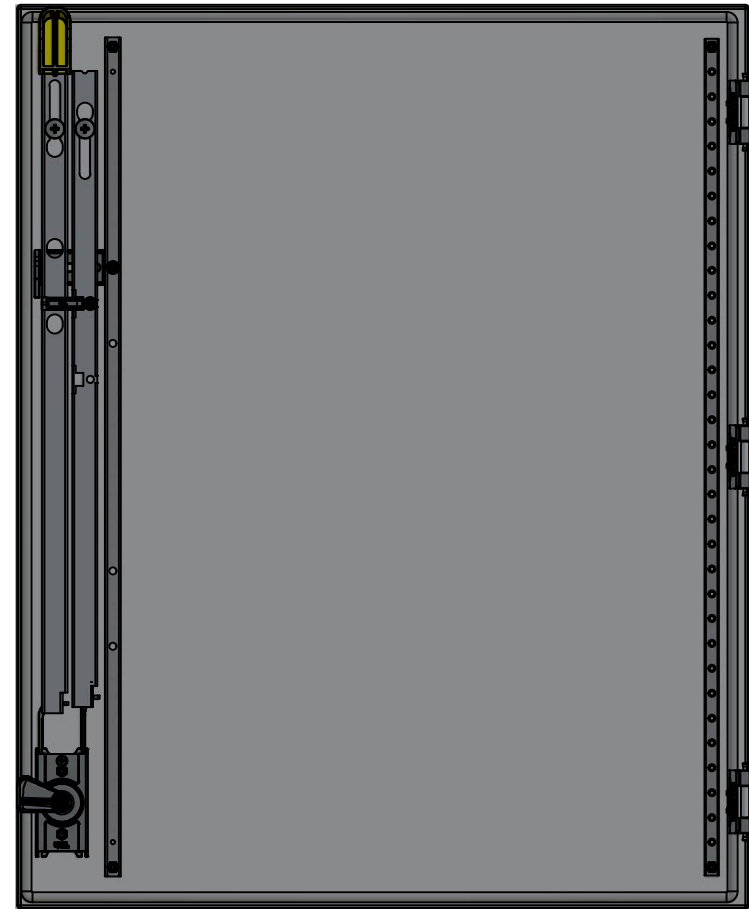
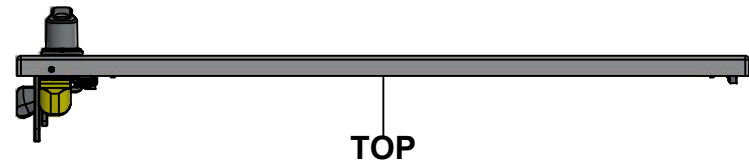

No.	Revisions	Date	By/Par

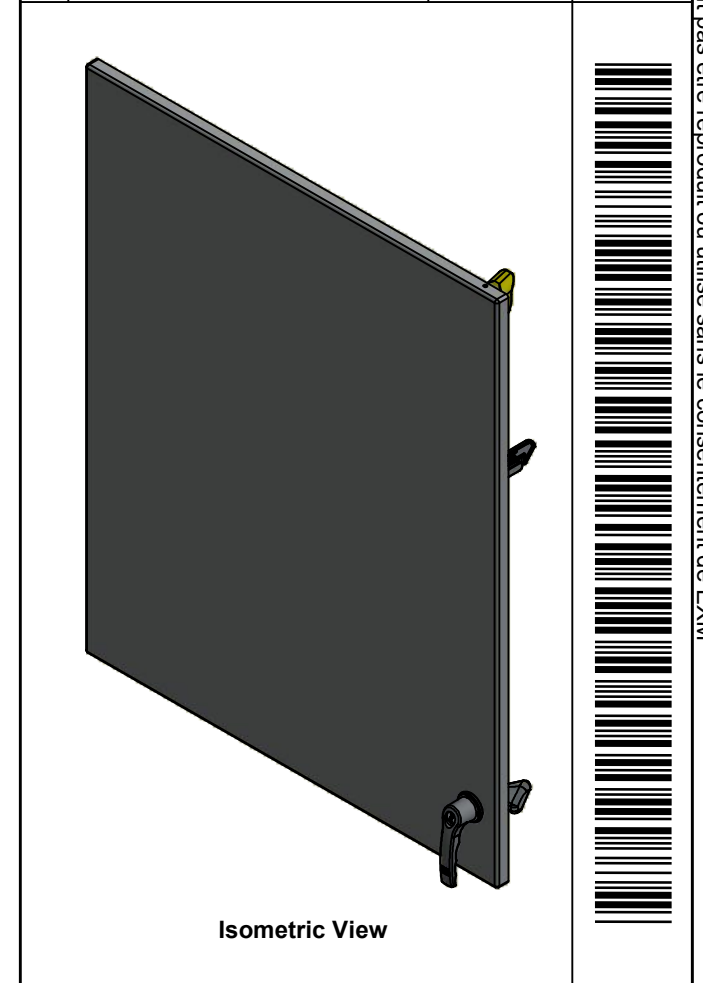

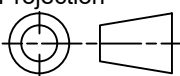
 Tél: (450) 979-4373 Fax: (450) 979-4626 www.exmweb.com		Flatness Aplatissement Max 3.0mm Projection 
Customer Client	Date	
Drawn By Dessiné Par	BoxCad: BoxCad	Date 2014-10-23
Material Matière	14 Ga Cold Rolled A1008 CS Type B (1.7mm)	
Color Couleur	Asa-61 Grey	Finish Fini Smooth
Description	Detail Rev.	
5500ESY 36" x 31.375" Cover		
Part Number Numéro Pièce	Rev.	7
5500ESY363110C	0	9

SEE BILL OF MATERIAL ON LAST PAGE

This drawing is confidential and must not be reproduced or used without the consent of EXM

Ce dessin est confidentiel et ne doit pas être reproduit ou utilisé sans le consentement de EXM

STANDARD FEATURES ARE NOT LISTED IN THIS HOLE TABLE

HOLE TABLE - FRONT VIEW (CUSTOM FEATURE ONLY)

CUT-OUT	XDIM	YDIM	DESCRIPTION
1	1.486	1.661	STUD M6 x 18mm (Inside)
2	1.486	34.142	STUD M6 x 18mm (Inside)
3	25.194	34.142	STUD M6 x 18mm (Inside)
4	25.194	1.661	STUD M6 x 18mm (Inside)
5	27.496	25.401	STUD M6 x 18mm (Inside)
6	27.496	22.401	STUD M6 x 18mm (Inside)
7	27.496	30.896	STUD M6 x 18mm (Inside)
8	26.311	30.896	STUD M6 x 18mm (Inside)
9	27.219	2.969	STUD M6 x 18mm (Inside)
10	27.219	5.469	STUD M6 x 18mm (Inside)
-----	-----	-----	-----
11	27.219	4.219	HANDLE 885 ESL2A @ 0.0°

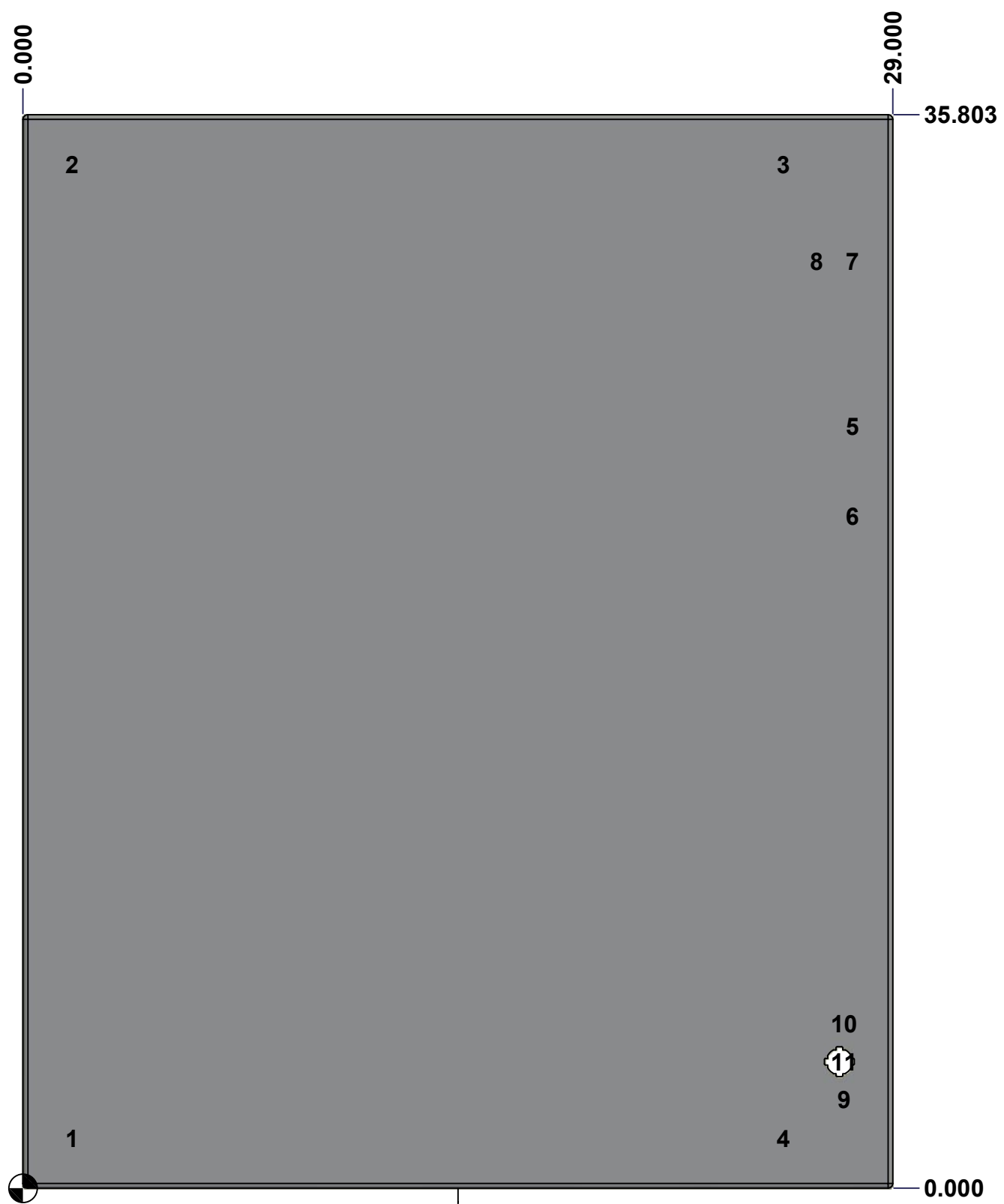

FRONT

	Description	Status
	5500ESY 36" x 31.375" Cover	(NULL)
	Part Number Numéro Pièce	Rev.
	5500ESY363110C	0 / 8
		9

This drawing is confidential and must not be reproduced or used without the consent of EXM

Ce dessin est confidentiel et ne doit pas être reproduit ou utilisé sans le consentement de EXM

No.	Revisions	Date	By/Par

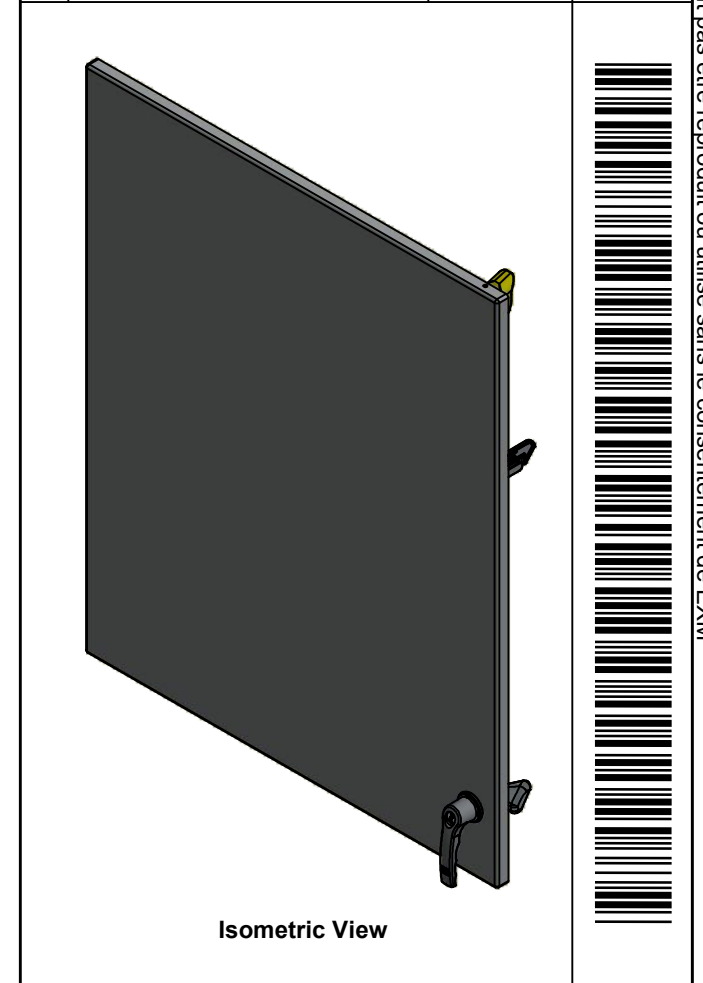

1	STK-A-881DBAR_ESY-36	3	5500 ESY Defeater Bar 36"
1	STK-A-881CBAR_ESY-36	4	5500 ESY Closing Bar 36"
1	STK-K-03890-32	3	Gearbox Clockwise Assembly (Grip 32mm)
1	885 ESL2A	4	5412 ES Key Lock L-Handle (3 Pts)
1	STK-P-02400S	0	Powder Paint (Asa-61 Grey / Smooth)
1	STK-Q-03200	0	M6 x 8mm Hexagon/Slot Screw
1	STK-Q-13060	1	M6 Flat Washer
1	STK-Q-46600	3	5500 ESY Disconnect Door Hook
1	STK-Q-46021-36	2	5500 ESY Vertical Door Stiffener 36"
1	STK-Q-46020-36	5	5412 ES Vertical Door Stiffener 36"
10	STK-Q-16055	1	M6 x 18mm Stud (No Paint Cap Required)
1	5500ESY363110G	0	5500ESY 36" x 31.375" Cover Gasket
1	5500ESY363110C-P	0	5500ESY 36" x 31.375" Cover Part
3	STK-K-09800	10	5412 ES Hinge with 2 Captive Hinge Pins
5	STK-Q-07220	1	M6 Nylon Insert Lock Nut

Qty	Part Name	Rev	Description
Parts List			

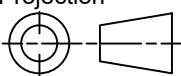
 Tél: (450) 979-4373 Fax: (450) 979-4626 www.exmweb.com	Flatness Aplatissement
	Max 3.0mm
Projection	
Customer Client	Date
Drawn By Dessiné Par BoxCad: BoxCad	Date 2014-10-23
Material Matière	14 Ga Cold Rolled A1008 CS Type B (1.7mm)
Color Couleur	Asa-61 Grey
Finish Fini	Smooth
Description	Detail Rev.
5500ESY 36" x 31.375" Cover	
Part Number Numéro Pièce	Rev. 9
5500ESY363110C	0 9

This drawing is confidential and must not be reproduced or used without the consent of EXM

Ce dessin est confidentiel et ne doit pas être reproduit ou utilisé sans le consentement de EXM

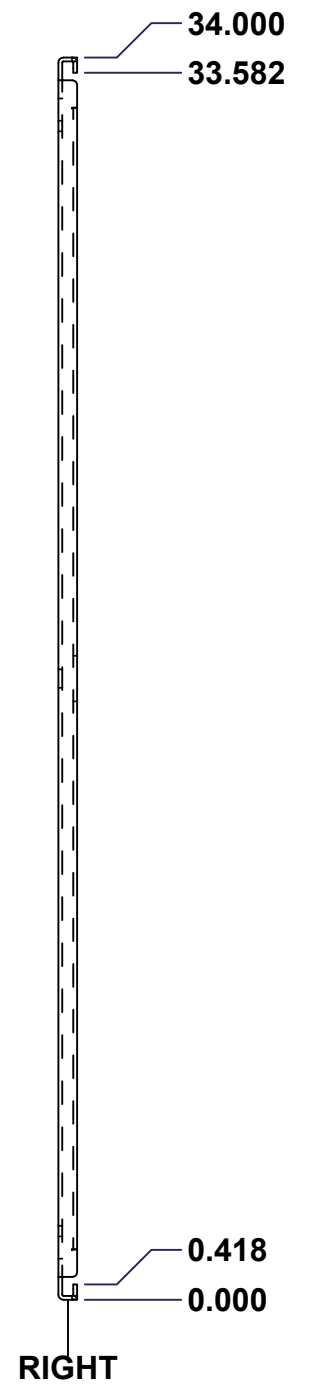
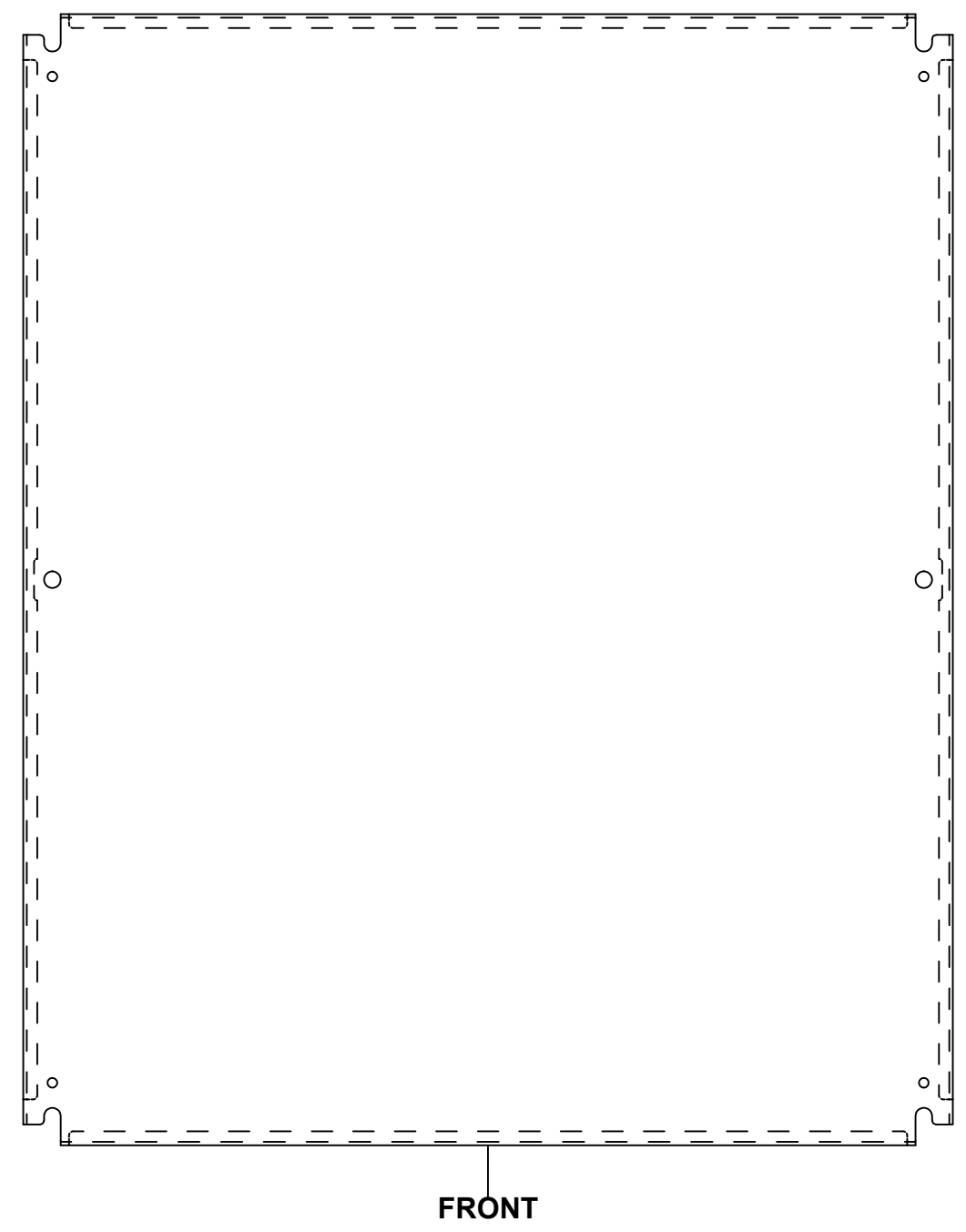
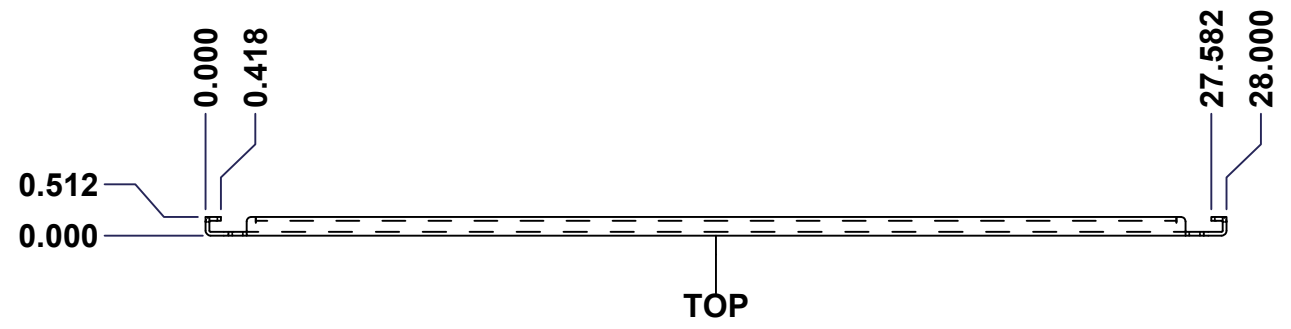

No.	Revisions	Date	By/Par

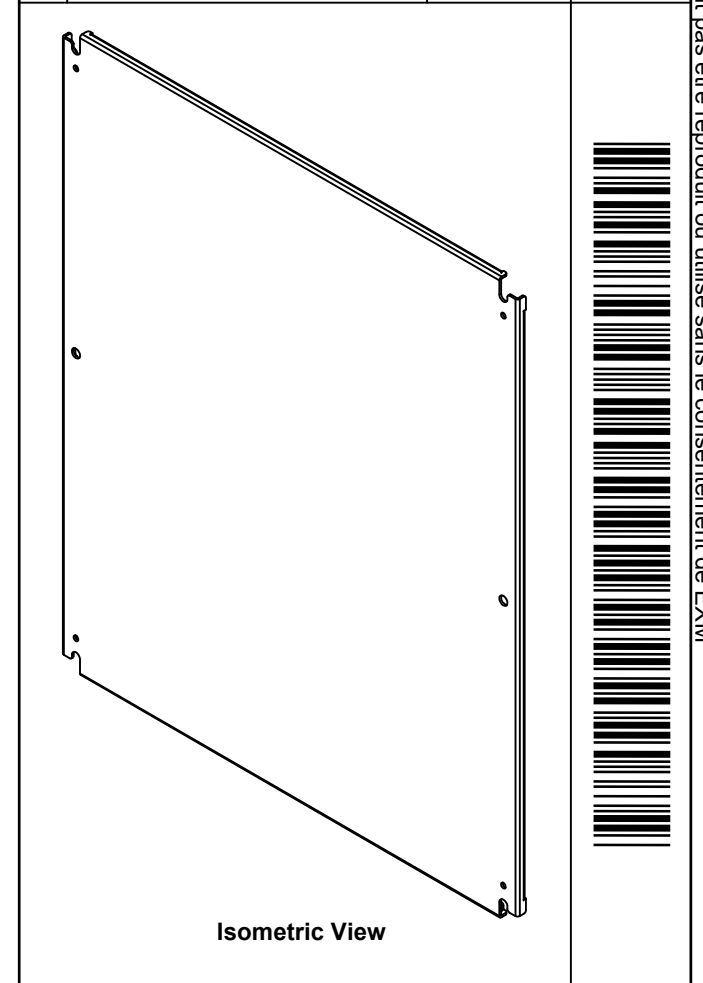

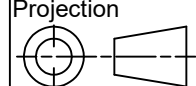
 Tél: (450) 979-4373 Fax: (450) 979-4626 www.exmweb.com		Flatness Aplatissement Max 3.0mm Projection 
Customer Client	Date	
Drawn By Dessiné Par	BoxCad	Date 1/23/2007
Material Matière	See Part List	
Color Couleur	See Part List	Finish Fini See Part List
Description		Detail Rev.
881 SP - Inner Panel		
Part Number Numéro Pièce	881 SP3630G	Rev. 1 0 2

Qty	Part Number	Rev	Description	Material	Color	Finish
1	881 SP3630G-P	0	881 SP - Inner Panel Part	12 Ga Galvanized	Unpainted	Galvanized

Parts List

This drawing is confidential and must not be reproduced or used without the consent of EXM

Ce dessin est confidentiel et ne doit pas être reproduit ou utilisé sans le consentement de EXM

Table 1			FRONT VIEW
CUT-OUT	XDIM	YDIM	DESCRIPTION
1	0.875	1.875	GROUND HOLE (RND Ø0.290)
2	27.125	1.875	GROUND HOLE (RND Ø0.290)
3	0.875	32.125	GROUND HOLE (RND Ø0.290)
4	27.125	32.125	GROUND HOLE (RND Ø0.290)
5	0.875	17.000	MTG STUD HOLE (RND Ø0.500)
6	27.125	17.000	MTG STUD HOLE (RND Ø0.500)

All knockouts are actual size / Les disques défonçables sont grandeur réel

No.	Revisions	Date	By/Par

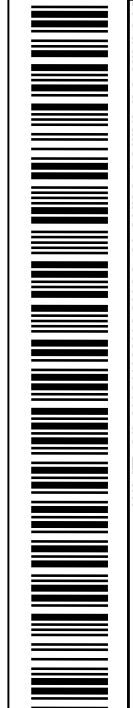
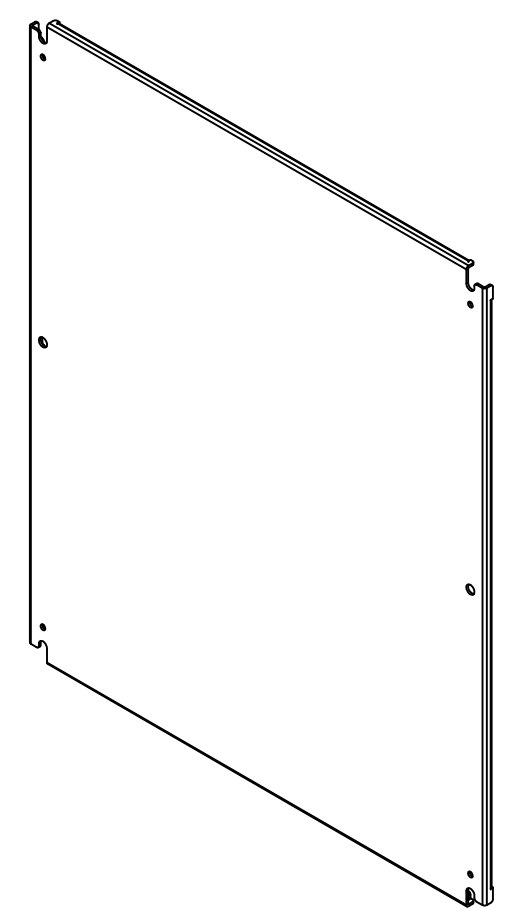
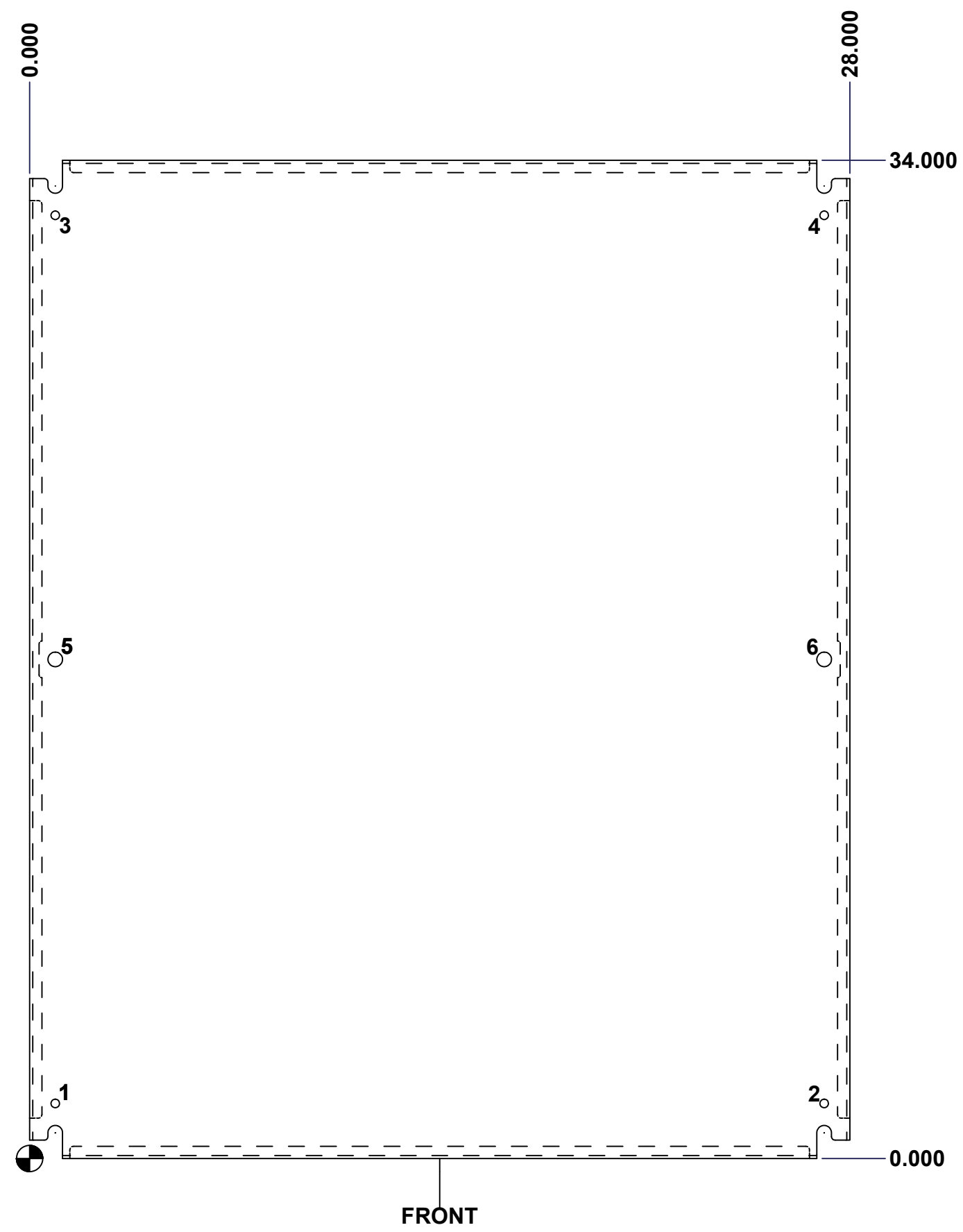

	Tél: (450) 979-4373 Fax: (450) 979-4626 www.exmweb.com	Flatness Aplatissement Max 3.0mm
		Projection
Customer Client		Date
Drawn By Dessiné Par	BoxCad	Date 1/23/2007
Material Matière	See Part List	
Color Couleur	See Part List	Finish Fini See Part List
Description 881 SP - Inner Panel		Detail Rev.
Part Number Numéro Pièce	881 SP3630G	Rev. 2 0