

This drawing is confidential and must not be reproduced or used without the consent of EXM

Ce dessin est confidentiel et ne doit pas être reproduit ou utilisé sans le consentement de EXM

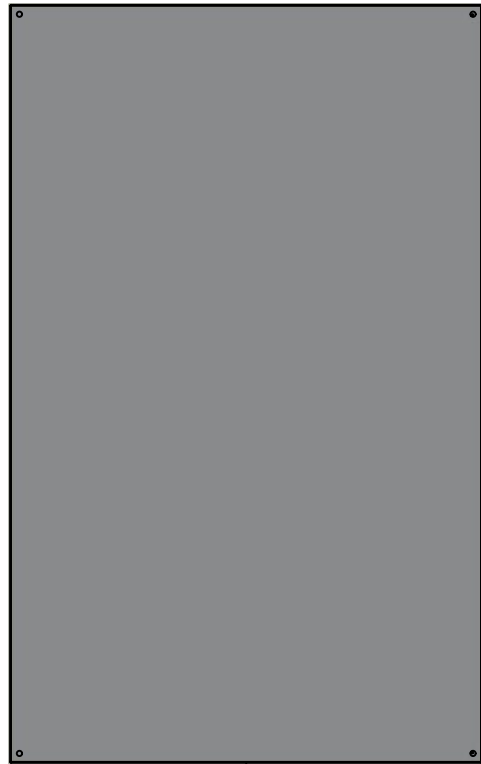

TOP



BACK

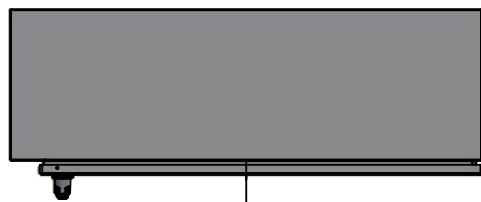

BOTTOM

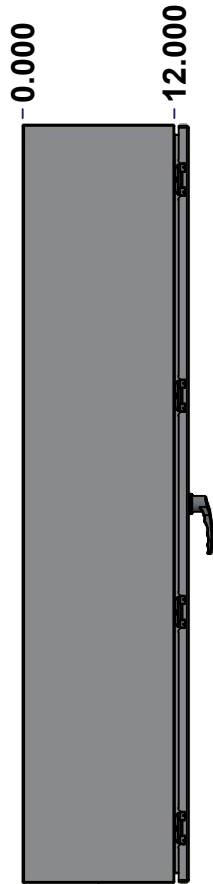

LEFT

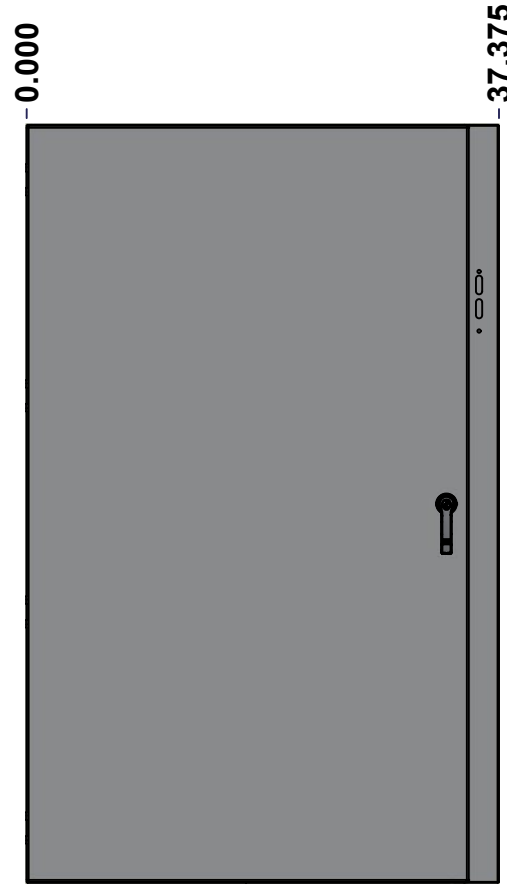

FRONT

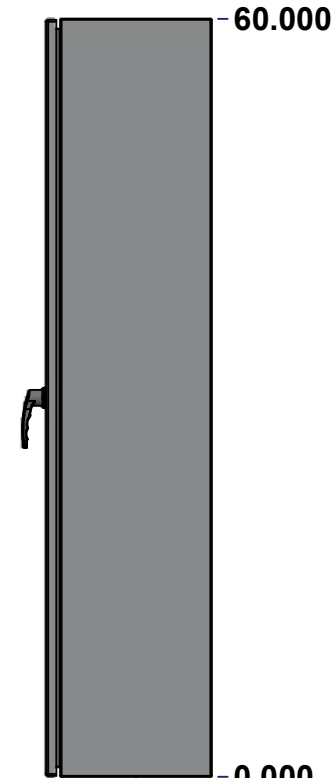

RIGHT

No.	Revisions	Date	By/Par

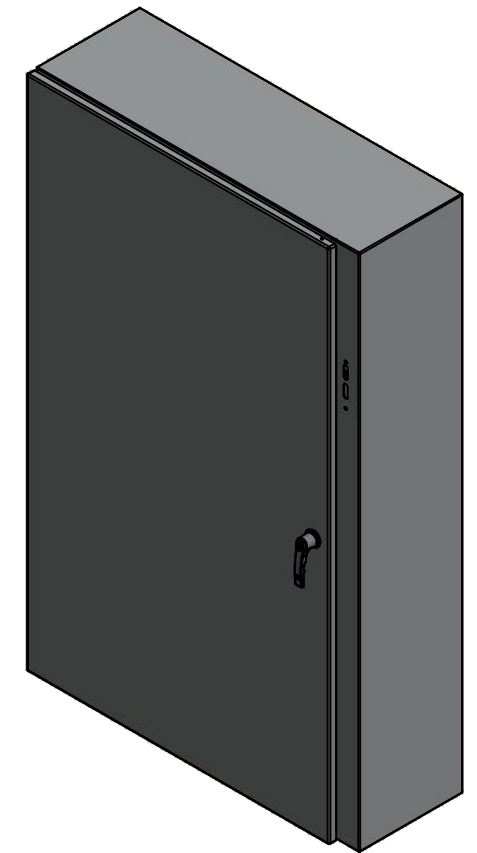

Isometric View



Tél: (450) 979-4373
 Fax: (450) 979-4626
www.exmweb.com

Flatness
Aplatissement

Max 3.0mm

Projection



Customer Client	Date
Drawn By Dessiné Par BoxCad: BoxCad	Date 10/27/2014
Material Matière 14 Ga Cold Rolled A1008 CS Type B (1.7mm)	

Color Couleur Asa-61 Grey	Finish Fini Smooth
------------------------------	-----------------------

Description 5500ESY 60" x 37.375" x 12" Assembly	Detail Rev.
---	-------------

Part Number Numéro Pièce 5500ESY603712	Rev. 0	1	9
---	--------	---	---

SEE BILL OF MATERIAL ON LAST PAGE

This drawing is confidential and must not be reproduced or used without the consent of EXM

Ce dessin est confidentiel et ne doit pas être reproduit ou utilisé sans le consentement de EXM

NOTE	
ITEM	DESCRIPTION
1	NEMA 12/13 Enclosure
2	C/W Standard ground studs on box and cover
3	C/W Standard door stiffener
4	C/W Standard inner panel (Included)
5	C/W Standard inner panel mounting studs
6	C/W 880 PP included (Not installed)

No.	Revisions	Date	By/Par

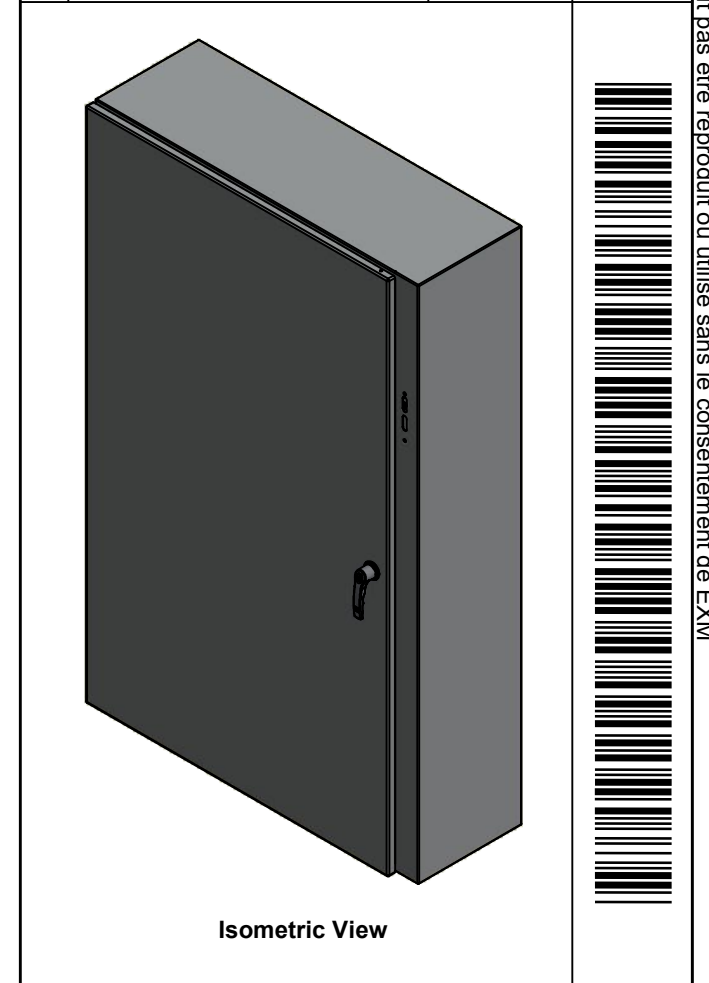

PACKING		
ITEM	QTY	DESCRIPTION
Cardboard sleeve	2	Top and Bottom
Cardboard strip	2	Between back of enclosure and inner panel
Plastic bag	1	To protect cover surface and inside gasket
Cardboard corner	4	To reinforced for the plastic strap tightening
Plastic strap - Black	2	To Squeeze 2 cardboard sleeve together
Packaging label	3	White label with PN
Plastic strap- Green	2	To secure the enclosure to the wood pallet
Wood Pallet	1	2" deeper and 3" larger than enclosure size

1	880 PP	6	Self Adhesive Print Pocket
1	STK-K-01800	5	5412 ES Accessory Kit
1	5500ESY603712C	0	5500ESY 60" x 37.375" Cover
8	STK-Q-07310	2	Flange Lock Nut M8
1	881 SP6036G	0	881 SP - Inner Panel
8	STK-Q-07610	8	M8 Plastic Spacer 22.2mm
1	5500ESY603712B	0	5500ESY 60" x 37.375" x 12" Body
4	STK-Q-04050-07	7	M6 x 7mm Hexagon Socket Head Machine Screw with Nyseal
Qty	Part Number	Rev	Description
Parts List			

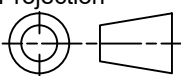
 Tél: (450) 979-4373 Fax: (450) 979-4626 www.exmweb.com		Flatness Aplatissement Max 3.0mm Projection 
Customer Client	Date	
Drawn By Dessiné Par	BoxCad: BoxCad	Date 10/27/2014
Material Matière	14 Ga Cold Rolled A1008 CS Type B (1.7mm)	
Color Couleur	Asa-61 Grey	Finish Fini Smooth
Description	Detail Rev.	
5500ESY 60" x 37.375" x 12" Assembly		
Part Number Numéro Pièce	Rev.	2
5500ESY603712	0	9

This drawing is confidential and must not be reproduced or used without the consent of EXM

Ce dessin est confidentiel et ne doit pas être reproduit ou utilisé sans le consentement de EXM



TOP



BACK



BOTTOM

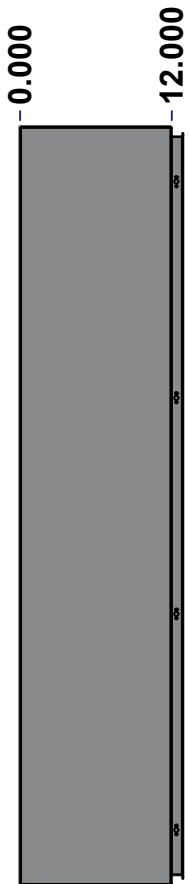

LEFT

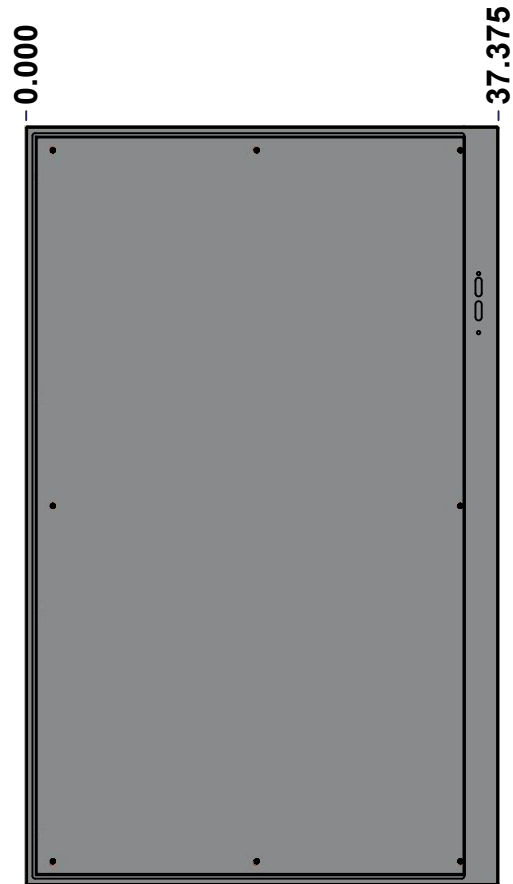

FRONT

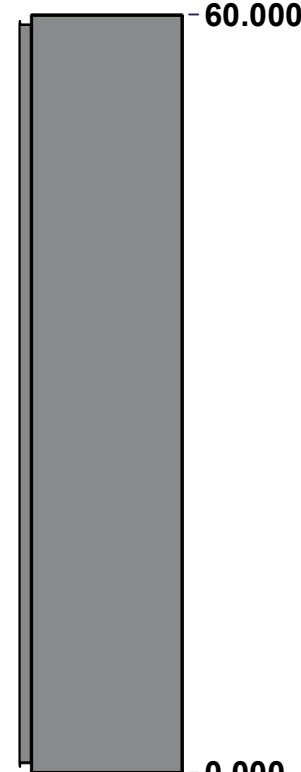

RIGHT

No.	Revisions	Date	By/Par

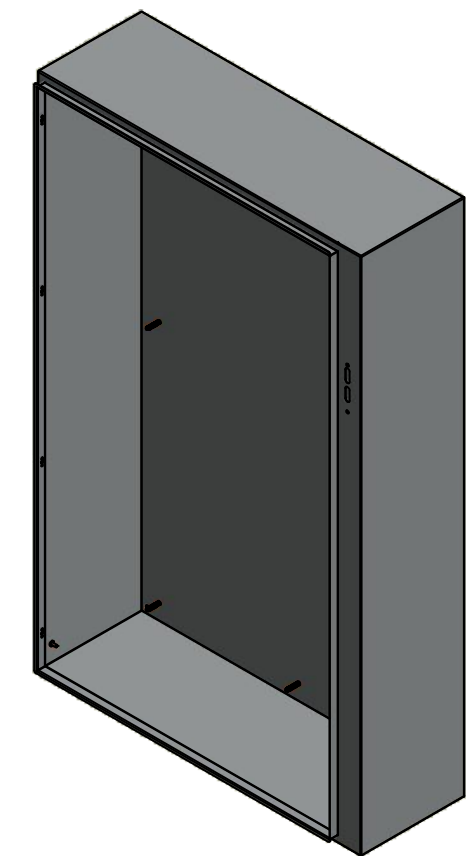

Isometric View



Tél: (450) 979-4373
 Fax: (450) 979-4626
www.exmweb.com

Flatness
Aplatissement
Max 3.0mm
Projection

Customer Client	Date
Drawn By / Dessiné Par: BoxCad: BoxCad	Date: 10/27/2014
Material / Matière: 14 Ga Cold Rolled A1008 CS Type B (1.7mm)	
Color / Couleur: Asa-61 Grey	Finish / Fini: Smooth
Description: 5500ESY 60" x 37.375" x 12" Body	
Part Number / Numéro Pièce: 5500ESY603712B	Detail Rev.:
Rev. 0	3 / 9

SEE BILL OF MATERIAL ON LAST PAGE

This drawing is confidential and must not be reproduced or used without the consent of EXM

Ce dessin est confidentiel et ne doit pas être reproduit ou utilisé sans le consentement de EXM

STANDARD FEATURES ARE NOT LISTED IN THIS HOLE TABLE			
HOLE TABLE - LEFT VIEW (CUSTOM FEATURE ONLY)			
CUT-OUT	XDIM	YDIM	DESCRIPTION
1	10.500	2.000	GND STUD M6 x 16mm (Inside)

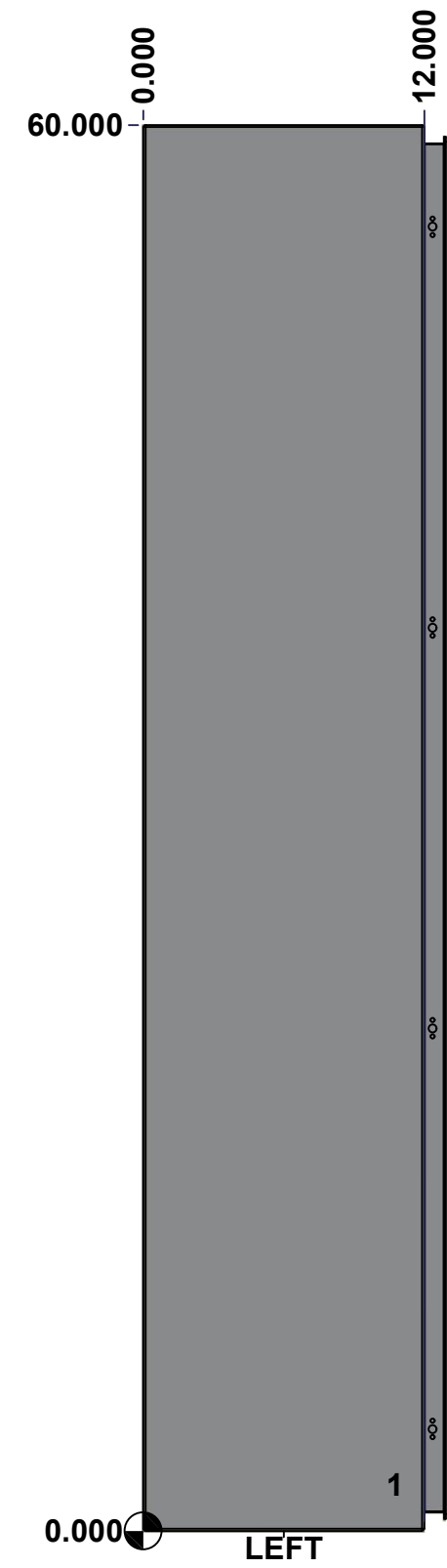

	Description	Status	
	5500ESY 60" x 37.375" x 12" Body	(NULL)	
	Part Number Numéro Pièce	Rev.	
	5500ESY603712B	0	4 9

This drawing is confidential and must not be reproduced or used without the consent of EXM

Ce dessin est confidentiel et ne doit pas être reproduit ou utilisé sans le consentement de EXM

STANDARD FEATURES ARE NOT LISTED IN THIS HOLE TABLE

HOLE TABLE - BACK VIEW (CUSTOM FEATURE ONLY)

CUT-OUT	XDIM	YDIM	DESCRIPTION
1	3.000	1.875	IP STUD M8 x 35mm (Inside)
2	3.000	58.125	IP STUD M8 x 35mm (Inside)
3	35.250	58.125	IP STUD M8 x 35mm (Inside)
4	35.250	1.875	IP STUD M8 x 35mm (Inside)
5	3.000	30.000	IP STUD M8 x 35mm (Inside)
6	35.250	30.000	IP STUD M8 x 35mm (Inside)
7	19.125	1.875	IP STUD M8 x 35mm (Inside)
8	19.125	58.125	IP STUD M8 x 35mm (Inside)

9	36.625	0.750	RND Ø0.390
10	36.625	59.250	RND Ø0.390
11	0.750	59.250	RND Ø0.390
12	0.750	0.750	RND Ø0.390

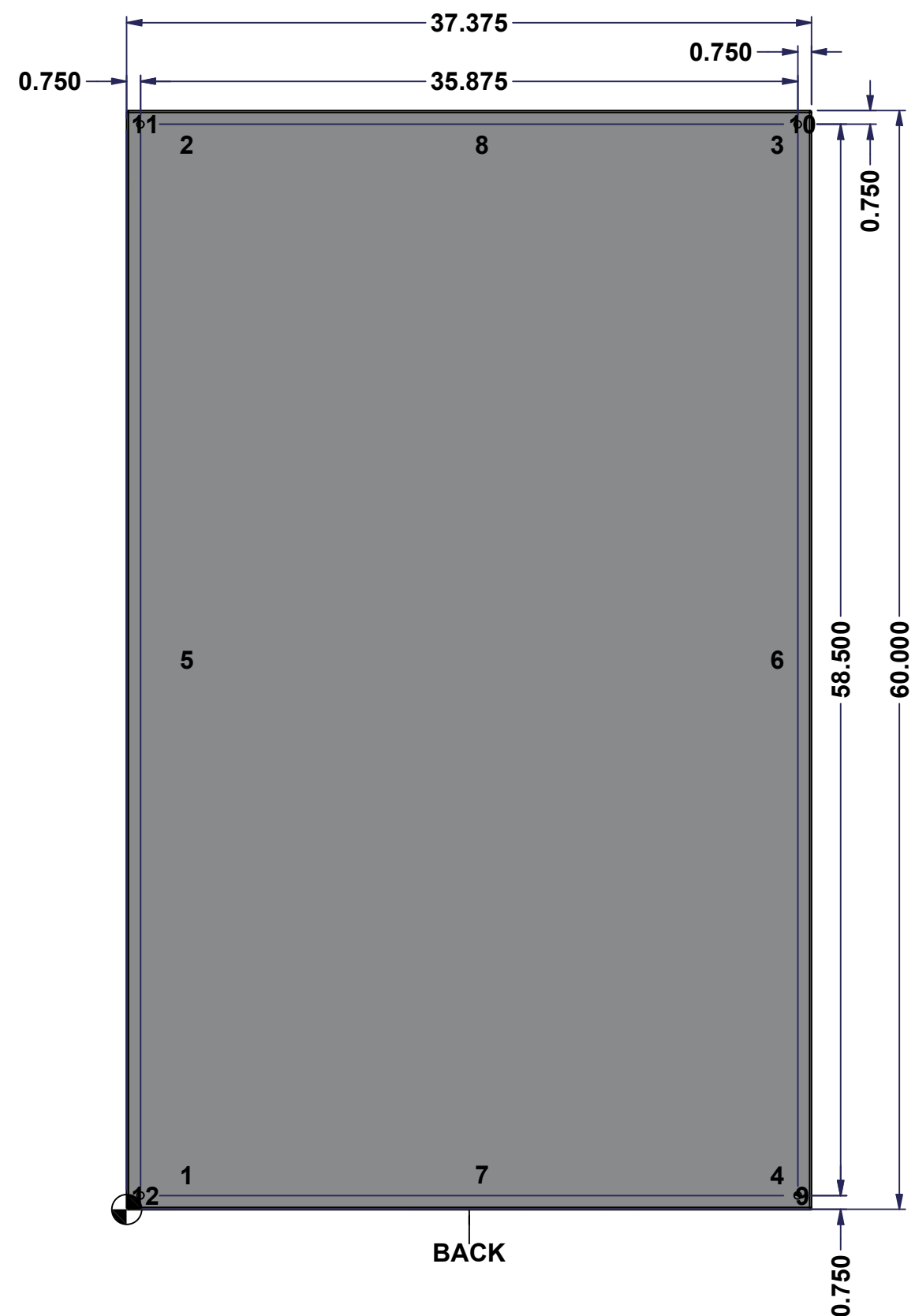

	Description		Status
	5500ESY 60" x 37.375" x 12" Body		(NULL)
Part Number Numéro Pièce		Rev.	5
5500ESY603712B		0	9

This drawing is confidential and must not be reproduced or used without the consent of EXM

Ce dessin est confidentiel et ne doit pas être reproduit ou utilisé sans le consentement de EXM

No.	Revisions	Date	By/Par

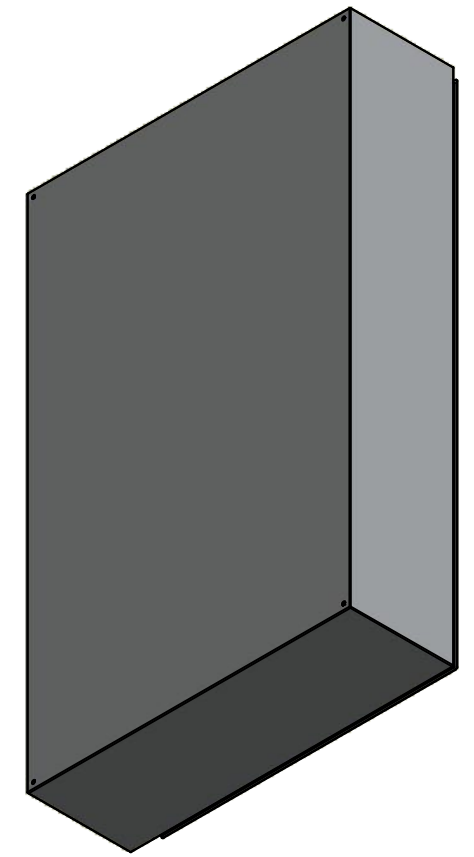

Isometric View

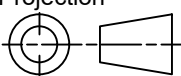

 Tél: (450) 979-4373 Fax: (450) 979-4626 www.exmweb.com		Flatness Aplatissement Max 3.0mm
Customer Client		Projection 
Drawn By Dessiné Par BoxCad: BoxCad		Date 10/27/2014
Material Matière 14 Ga Cold Rolled A1008 CS Type B (1.7mm)		
Color Couleur Asa-61 Grey	Finish Fini Smooth	
Description 5500ESY 60" x 37.375" x 12" Body		Detail Rev.
Part Number Numéro Pièce 5500ESY603712B		Rev. 6 0

Qty	Part Number	Rev	Description
1	STK-Q-16080	0	Ground Stud M6 x 16mm
1	STK-P-02400S	0	Powder Paint (Asa-61 Grey / Smooth)
8	STK-Q-16005	1	Stud M8 x 35 (No Paint Cap Required)
1	5500ESY603712B-P	0	5500ESY 60" x 37.375" x 12" Body Part
Parts List			

This drawing is confidential and must not be reproduced or used without the consent of EXM

Ce dessin est confidentiel et ne doit pas être reproduit ou utilisé sans le consentement de EXM

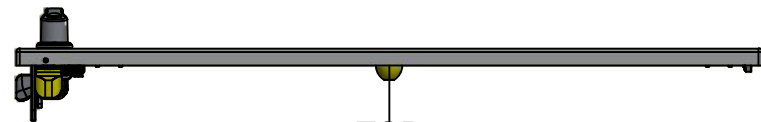

TOP

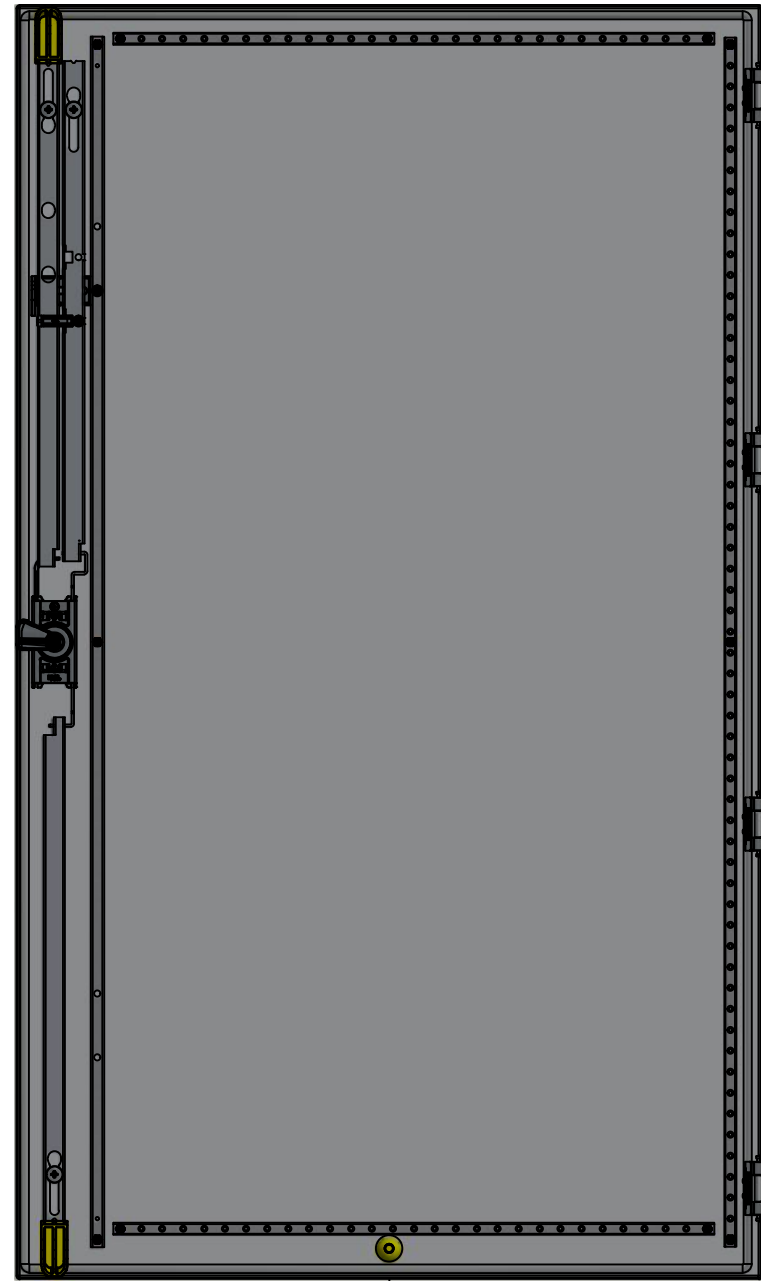

BACK

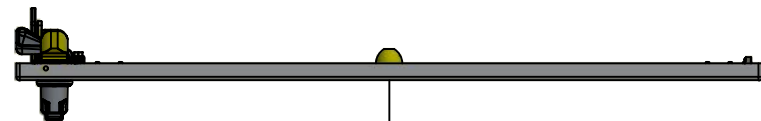

BOTTOM

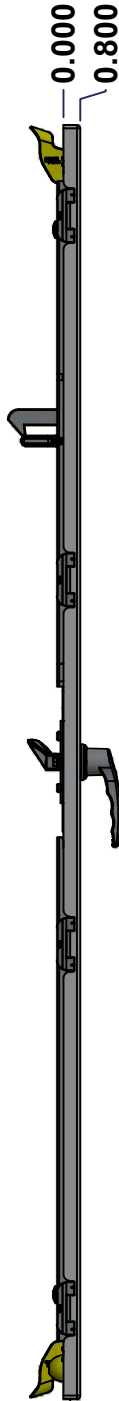

LEFT

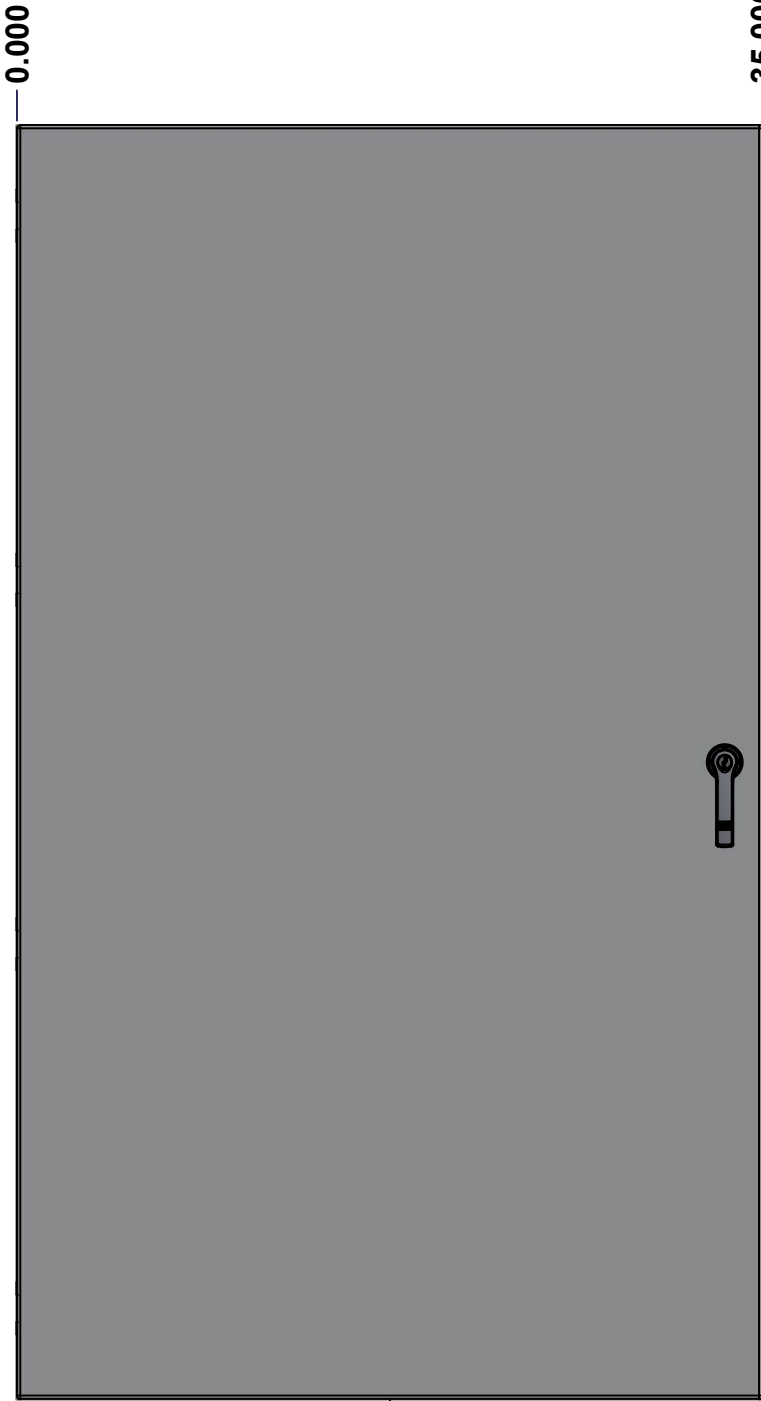

FRONT

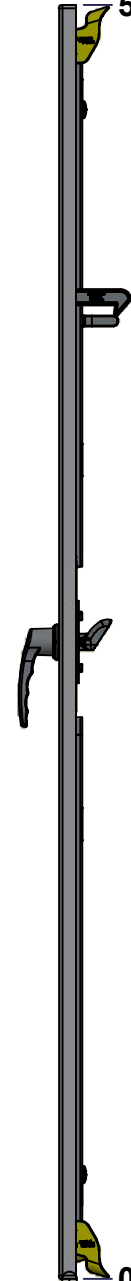

RIGHT

0.000
0.800

0.000

35.000

59.803

0.000

No.	Revisions	Date	By/Par

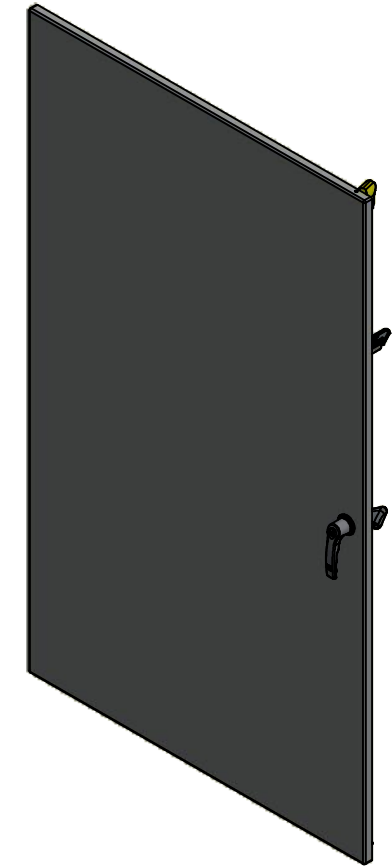

Isometric View



Tél: (450) 979-4373
Fax: (450) 979-4626
www.exmweb.com

Flatness
Aplatissement

Max 3.0mm

Projection

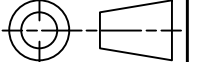

Customer Client	Date
Drawn By Dessiné Par BoxCad: BoxCad	Date 10/27/2014
Material Matière 14 Ga Cold Rolled A1008 CS Type B (1.7mm)	
Color Couleur Asa-61 Grey	Finish Fini Smooth
Description 5500ESY 60" x 37.375" Cover	Detail Rev.
Part Number Numéro Pièce 5500ESY603712C	Rev. 7 0 9

SEE BILL OF MATERIAL ON LAST PAGE

This drawing is confidential and must not be reproduced or used without the consent of EXM

Ce dessin est confidentiel et ne doit pas être reproduit ou utilisé sans le consentement de EXM

STANDARD FEATURES ARE NOT LISTED IN THIS HOLE TABLE			
HOLE TABLE - FRONT VIEW (CUSTOM FEATURE ONLY)			
CUT-OUT	XDIM	YDIM	DESCRIPTION
1	1.486	1.850	STUD M6 x 18mm (Inside)
2	1.486	57.953	STUD M6 x 18mm (Inside)
3	31.194	57.953	STUD M6 x 18mm (Inside)
4	31.194	1.850	STUD M6 x 18mm (Inside)
5	1.486	29.902	STUD M6 x 18mm (Inside)
6	31.194	29.902	STUD M6 x 18mm (Inside)
7	2.560	2.350	STUD M6 x 18mm (Inside)
8	2.560	58.228	STUD M6 x 18mm (Inside)
9	30.120	58.228	STUD M6 x 18mm (Inside)
10	30.120	2.350	STUD M6 x 18mm (Inside)
11	17.500	1.435	STUD M6 x 18mm (Inside)
12	33.496	49.401	STUD M6 x 18mm (Inside)
13	33.496	46.401	STUD M6 x 18mm (Inside)
14	33.496	54.896	STUD M6 x 18mm (Inside)
15	32.311	54.896	STUD M6 x 18mm (Inside)
16	33.219	4.907	STUD M6 x 18mm (Inside)
17	33.219	28.652	STUD M6 x 18mm (Inside)
18	33.219	31.152	STUD M6 x 18mm (Inside)

19	33.219	29.902	HANDLE 885 ESL2A @ 0.0°

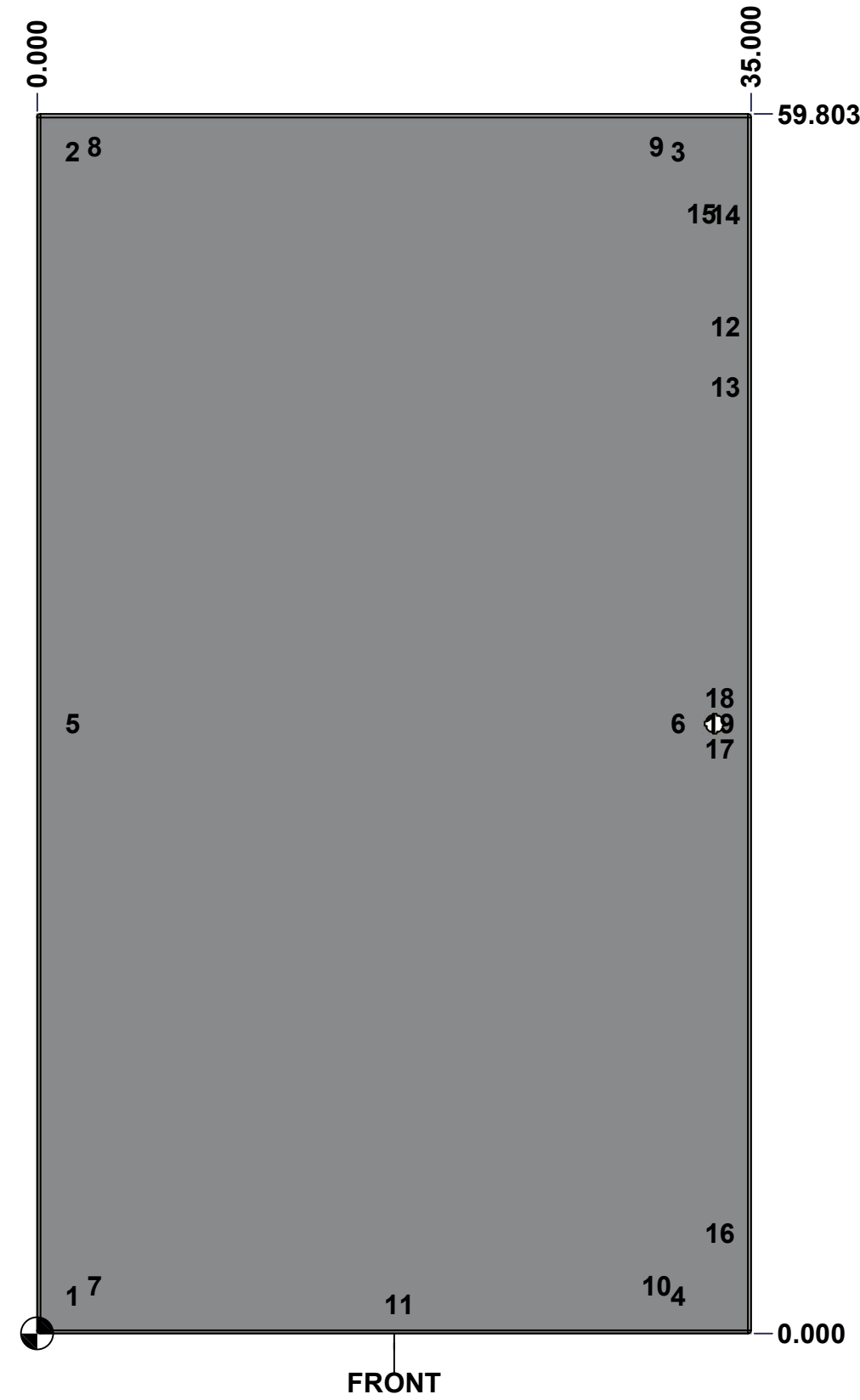

FRONT

	Description	Status	
	5500ESY 60" x 37.375" Cover	(NULL)	
	Part Number Numéro Pièce	Rev.	
	5500ESY603712C	0	8 9

This drawing is confidential and must not be reproduced or used without the consent of EXM

Ce dessin est confidentiel et ne doit pas être reproduit ou utilisé sans le consentement de EXM

No.	Revisions	Date	By/Par

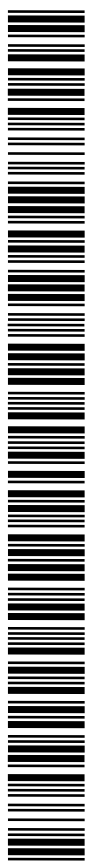
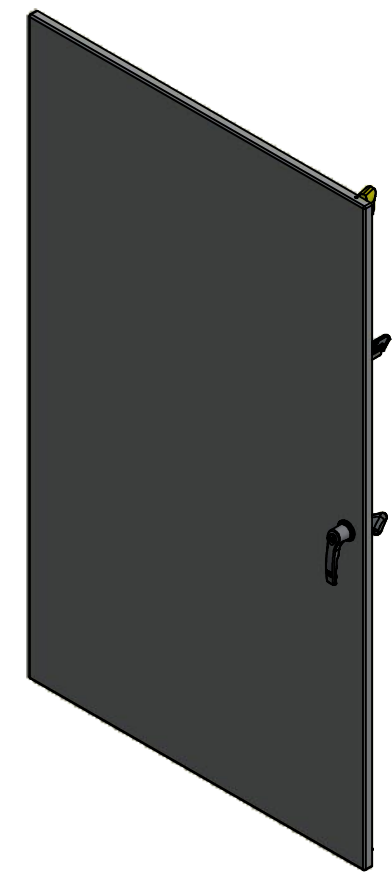

Isometric View

1	STK-A-881DBAR_ESY-60	3	5500 ESY Defeater Bar 60"
1	STK-A-45000-60	4	5500 ESDD Closing Bar 60"
1	STK-A-881CBAR_ESY-60	4	5500 ESY Closing Bar 60"
1	STK-K-03895-32	3	Gearbox Clockwise Assembly (Grip 32mm)
1	885 ESL2A	4	5412 ES Key Lock L-Handle (3 Pts)
1	STK-P-02400S	0	Powder Paint (Asa-61 Grey / Smooth)
1	STK-Q-46515	3	5412 ES Door Support with Brass Insert
1	STK-Q-03200	0	M6 x 8mm Hexagon/Slot Screw
1	STK-Q-13060	1	M6 Flat Washer
1	STK-Q-46600	3	5500 ESY Disconnect Door Hook
2	STK-Q-46026-37-3	3	5412 ESY Horizontal Door Stiffener 37.375"
1	STK-Q-46021-60	2	5500 ESY Vertical Door Stiffener 60"
1	STK-Q-46020-60	5	5412 ES Vertical Door Stiffener 60"
18	STK-Q-16055	1	M6 x 18mm Stud (No Paint Cap Required)
1	5500ESY603712G	0	5500ESY 60" x 37.375" Cover Gasket
1	5500ESY603712C-P	0	5500ESY 60" x 37.375" Cover Part
4	STK-K-09800	10	5412 ES Hinge with 2 Captive Hinge Pins
11	STK-Q-07220	1	M6 Nylon Insert Lock Nut

Qty	Part Name	Rev	Description
Parts List			

<p>Tél: (450) 979-4373 Fax: (450) 979-4626 www.exmweb.com</p>	Flatness Aplatissement	Max 3.0mm
	Projection	
Customer Client	Date	
Drawn By Dessiné Par	BoxCad: BoxCad	Date 10/27/2014
Material Matière	14 Ga Cold Rolled A1008 CS Type B (1.7mm)	
Color Couleur	Asa-61 Grey	Finish Fini Smooth
Description	Detail Rev.	
5500ESY 60" x 37.375" Cover		
Part Number Numéro Pièce	Rev.	9
5500ESY603712C	0	9

This drawing is confidential and must not be reproduced or used without the consent of EXM

Ce dessin est confidentiel et ne doit pas être reproduit ou utilisé sans le consentement de EXM



TOP

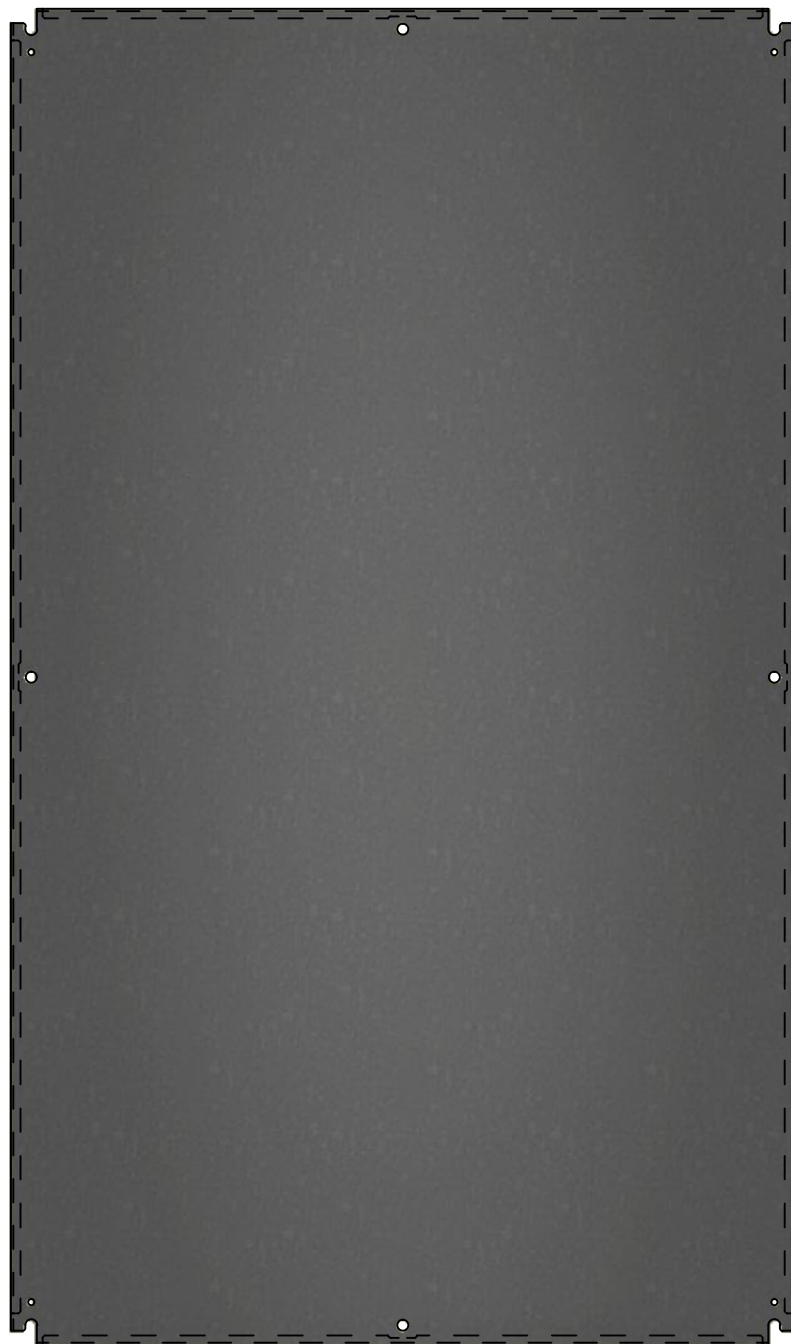

FRONT

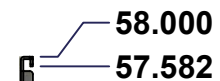

RIGHT

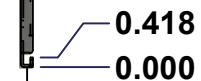

No.	Revisions	Date	By/Par

Isometric View

EXM
www.exmweb.com

Tél: (450) 979-4373
Fax: (450) 979-4626

Flatness
Aplatissement
Max 3.0mm

Projection

Customer Client	Date
Drawn By / Dessiné Par: BoxCad	Date: 1/23/2007

Material / Matière: See Part List

Color / Couleur: See Part List Finish / Fini: See Part List

Description: 881 SP - Inner Panel Detail Rev.

Qty	Part Number	Rev	Description	Material	Color	Finish
1	881 SP6036G-P	0	881 SP - Inner Panel Part	12 Ga Galvanized	Unpainted	Galvanized

Parts List

Part Number / Numéro Pièce: 881 SP6036G	Rev. 0	1 / 2
--	--------	-------

This drawing is confidential and must not be reproduced or used without the consent of EXM

Ce dessin est confidentiel et ne doit pas être reproduit ou utilisé sans le consentement de EXM

Table 1			FRONT VIEW
CUT-OUT	XDIM	YDIM	DESCRIPTION
1	17.000	0.875	MTG STUD HOLE (RND Ø0.500)
2	0.875	29.000	MTG STUD HOLE (RND Ø0.500)
3	33.125	29.000	MTG STUD HOLE (RND Ø0.500)
4	17.000	57.125	MTG STUD HOLE (RND Ø0.500)
5	0.875	1.875	GROUND HOLE (RND Ø0.290)
6	33.125	1.875	GROUND HOLE (RND Ø0.290)
7	0.875	56.125	GROUND HOLE (RND Ø0.290)
8	33.125	56.125	GROUND HOLE (RND Ø0.290)



All knockouts are actual size / Les disques défonçables sont grandeur réel

No.	Revisions	Date	By/Par

Isometric View

		Tél: (450) 979-4373 Fax: (450) 979-4626 www.exmweb.com		Flatness Aplatissement Max 3.0mm	
Customer Client		Date		Projection 	
Drawn By Dessiné Par BoxCad		Date 1/23/2007		Material Matière See Part List	
Color Couleur See Part List		Finish Fini See Part List		Description 881 SP - Inner Panel	
Part Number Numéro Pièce 881 SP6036G		Rev. 0		Detail Rev. 2 / 2	