

This drawing is confidential and must not be reproduced or used without the consent of EXM

Ce dessin est confidentiel et ne doit pas être reproduit ou utilisé sans le consentement de EXM

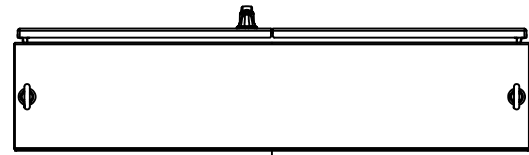

TOP

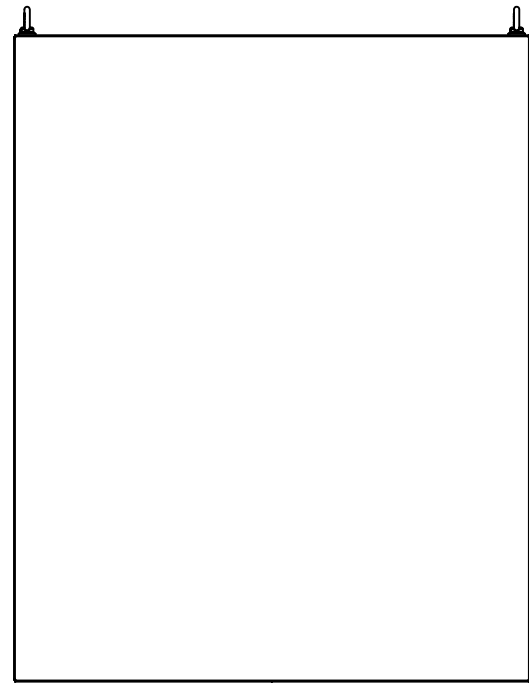

BACK

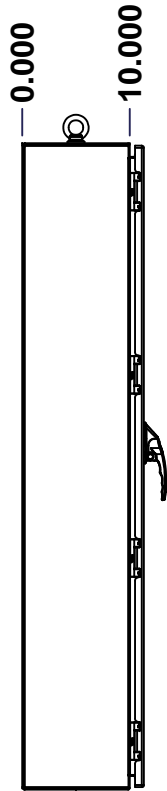

LEFT

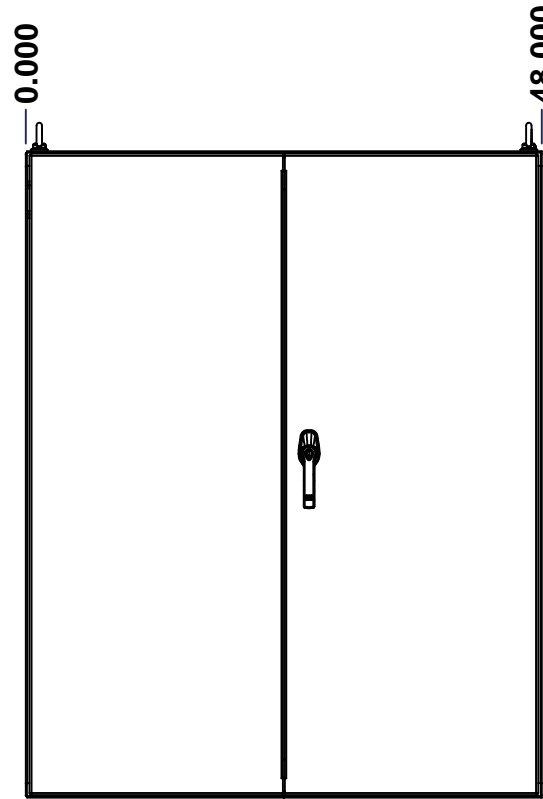

FRONT

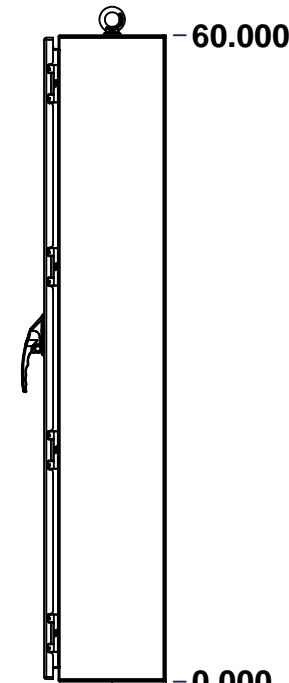

RIGHT



BOTTOM

**GRAIN DIRECTION:
TOP/BOTTOM: HORIZONTAL
LEFT/RIGHT/BACK/FRONT: VERTICAL**

SEE BILL OF MATERIAL ON LAST PAGE

No.	Revisions	Date	By/Par

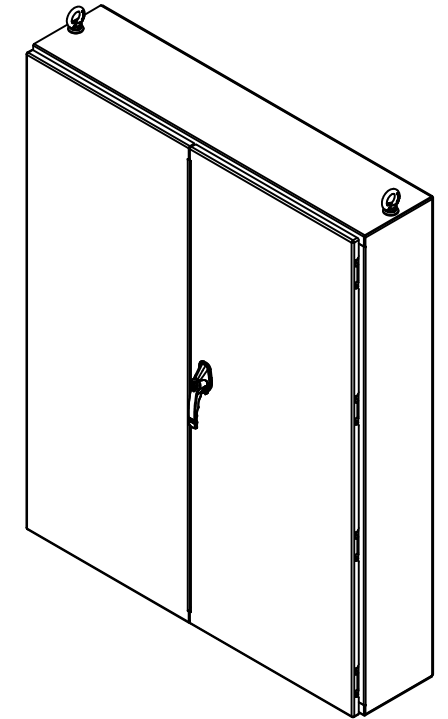

Isometric View



Tél: (450) 979-4373
Fax: (450) 979-4626
www.exmweb.com

Flatness
Aplatissement

Max 3.0mm

Projection

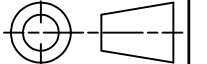

Customer Client	Date
Drawn By Dessiné Par BoxCad: BoxCad	Date 10-Mar-16
Material Matière 12 Ga Stainless Steel 304 (2.5mm)	
Color Couleur Unpainted	Finish Fini Brushed
Description 5500SSDD 60" x 48" x 10" Assembly	Detail Rev.
Part Number Numéro Pièce 5500SSDD604810	Rev. 1 0 2

This drawing is confidential and must not be reproduced or used without the consent of EXM

Ce dessin est confidentiel et ne doit pas être reproduit ou utilisé sans le consentement de EXM

NOTE	
ITEM	DESCRIPTION
1	NEMA 12/13 Enclosure
2	C/W Standard ground studs on box and cover
3	C/W Standard door stiffener
4	C/W Standard inner panel (Included)
5	C/W Standard inner panel mounting studs
6	C/W Struts installed (Included)
7	C/W Eyebolts

No.	Revisions	Date	By/Par

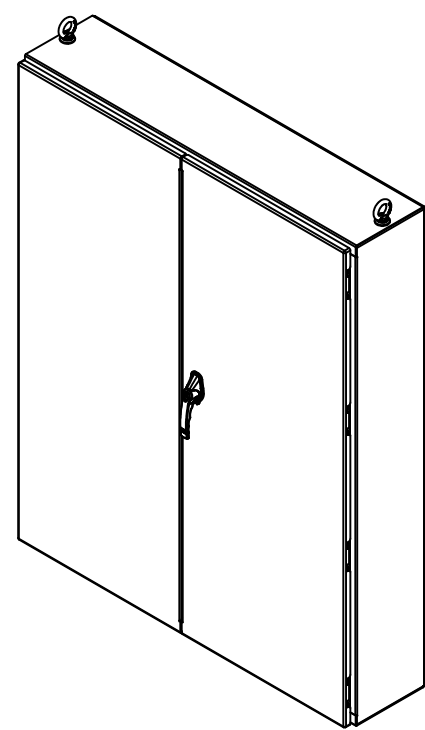

Isometric View



Tél: (450) 979-4373
 Fax: (450) 979-4626
www.exmweb.com

Flatness
Aplatissement
Max 3.0mm
Projection

Customer Client
 Drawn By Dessiné Par BoxCad: BoxCad
 Date 10-Mar-16

Material Matière 12 Ga Stainless Steel 304 (2.5mm)

Color Couleur Unpainted
 Finish Fini Brushed

Description 5500SSDD 60" x 48" x 10" Assembly
 Detail Rev.

Part Number Numéro Pièce **5500SSDD604810**
 Rev. 0

PACKING		
ITEM	QTY	DESCRIPTION
Cardboard sleeve	2	Top and Bottom
Cardboard strip	2	Between back of enclosure and inner panel
Plastic bag	1	To protect cover surface and inside gasket
Cardboard corner	4	To reinforced for the plastic strap tightening
Plastic strap - Black	2	To Squeeze 2 cardboard sleeve together
Packaging label	3	White label with PN
Plastic strap- Green	2	To secure the enclosure to the wood pallet
Wood Pallet	1	2" deeper and 3" larger than enclosure size

Qty	Part Number	Rev	Description
1	880EB14SS	2	Stainless Steel Eye Bolt M14 (Pack of 2)
8	STK-Q-07320	0	Flange Lock Nut M10
1	885SP6048G	0	885 SP6048G Inner Panel
6	STK-Q-07620	0	M10 Plastic Spacer 0.875"
1	5500SSDD604810FD	0	5500SSDD 60" x 48" Flange Door
1	5500SSDD604810LD	0	5500SSDD 60" x 48" Lock Door
1	5500SSDD604810B	0	5500SSDD 60" x 48" x 10" Body
2	5500SSDD604810GP	0	5500SSDD Gland Plate
8	STK-Q-04051-10	8	M6 Hexagon Socket Head Machine Screw with Nyseal
Parts List			

This drawing is confidential and must not be reproduced or used without the consent of EXM

Ce dessin est confidentiel et ne doit pas être reproduit ou utilisé sans le consentement de EXM



TOP

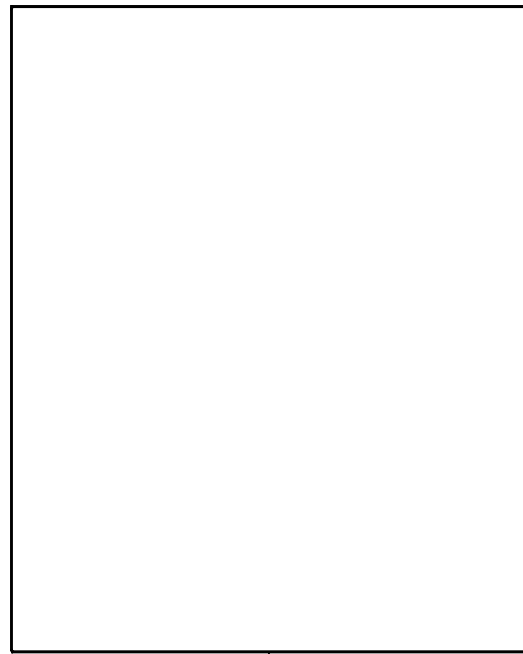

BACK

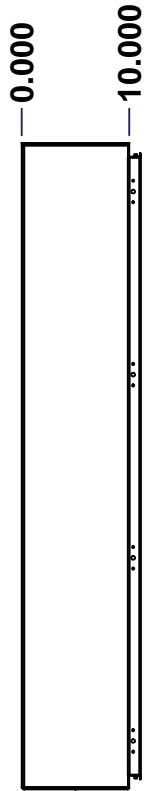

LEFT

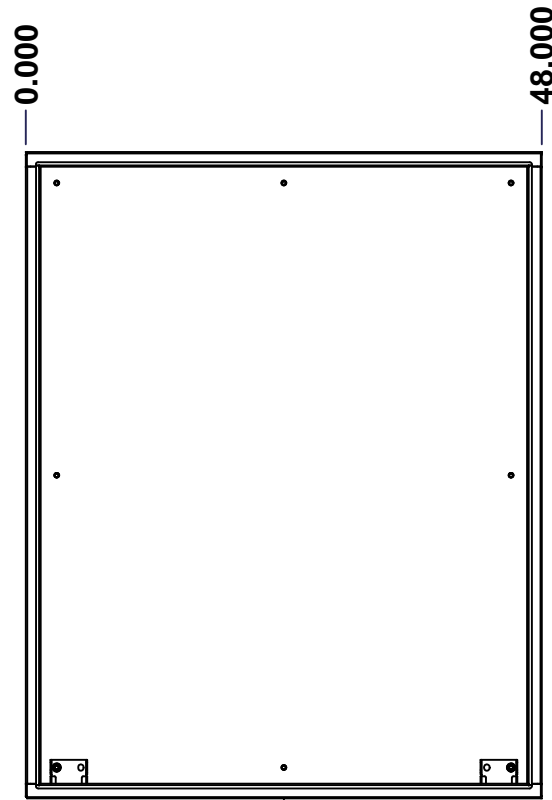

FRONT

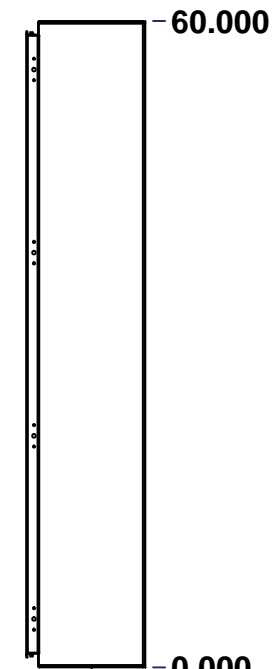

RIGHT

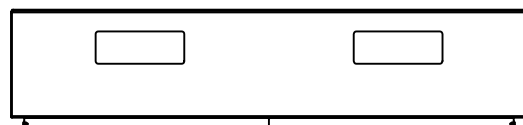

BOTTOM

No.	Revisions	Date	By/Par

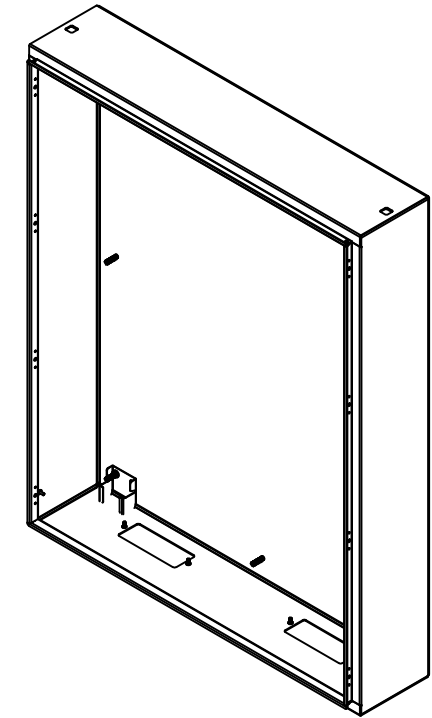

Isometric View



Tél: (450) 979-4373
 Fax: (450) 979-4626
www.exmweb.com

Flatness
Aplatissement

Max 3.0mm

Projection



Customer Client	Date
Drawn By Dessiné Par BoxCad: BoxCad	Date 10-Mar-16
Material Matière 12 Ga Stainless Steel 304 (2.5mm)	
Color Couleur Unpainted	Finish Fini Brushed
Description 5500SSDD 60" x 48" x 10" Body	Detail Rev.
Part Number Numéro Pièce 5500SSDD604810B	Rev. 1 0 2

SEE BILL OF MATERIAL ON LAST PAGE

This drawing is confidential and must not be reproduced or used without the consent of EXM

Ce dessin est confidentiel et ne doit pas être reproduit ou utilisé sans le consentement de EXM

STANDARD FEATURES ARE NOT LISTED IN THIS HOLE TABLE

HOLE TABLE - TOP VIEW (CUSTOM FEATURE ONLY)

CUT-OUT	XDIM	YDIM	DESCRIPTION
1	11.895	5.895	Struts CR400 17.500" (Inside)
2	35.895	5.895	Struts CR400 17.500" (Inside)
3	11.895	5.895	STUDS M6 x 10mm (Inside)
4	6.145	5.895	STUDS M6 x 10mm (Inside)
5	17.645	5.895	STUDS M6 x 10mm (Inside)
6	35.895	5.895	STUDS M6 x 10mm (Inside)
7	30.145	5.895	STUDS M6 x 10mm (Inside)
8	41.645	5.895	STUDS M6 x 10mm (Inside)

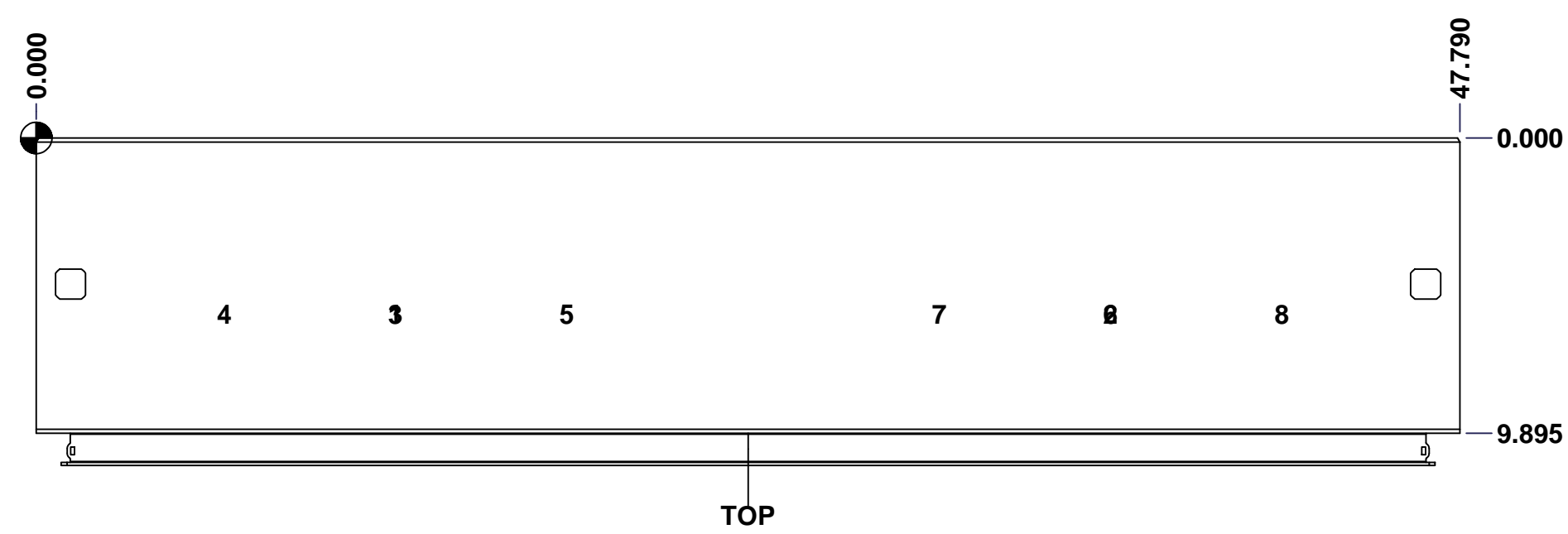

	Description	Status	
	5500SSDD 60" x 48" x 10" Body	Released	
	Part Number Numéro Pièce	Rev.	
	5500SSDD604810B	0	2 / 7

This drawing is confidential and must not be reproduced or used without the consent of EXM

Ce dessin est confidentiel et ne doit pas être reproduit ou utilisé sans le consentement de EXM

STANDARD FEATURES ARE NOT LISTED IN THIS HOLE TABLE

HOLE TABLE - RIGHT VIEW (CUSTOM FEATURE ONLY)

CUT-OUT	XDIM	YDIM	DESCRIPTION
1	8.395	3.270	GND STUD M6 x 16mm (Inside)

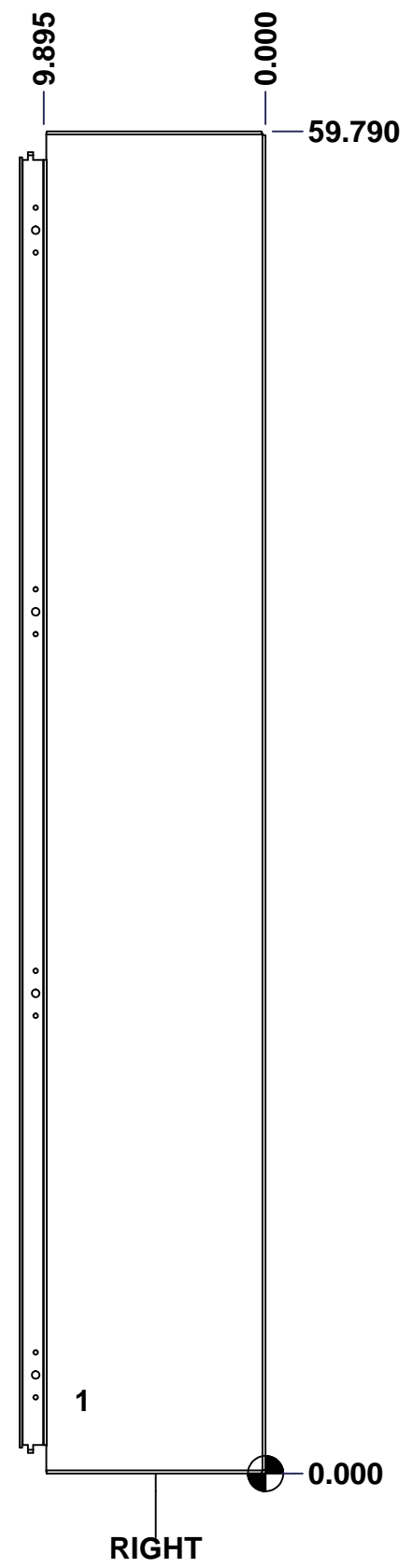

	Description	Status	
	5500SSDD 60" x 48" x 10" Body	Released	
	Part Number Numéro Pièce	Rev.	
	5500SSDD604810B	0	3 / 7

This drawing is confidential and must not be reproduced or used without the consent of EXM

Ce dessin est confidentiel et ne doit pas être reproduit ou utilisé sans le consentement de EXM

STANDARD FEATURES ARE NOT LISTED IN THIS HOLE TABLE			
HOLE TABLE - BOTTOM VIEW (CUSTOM FEATURE ONLY)			
CUT-OUT	XDIM	YDIM	DESCRIPTION
1	7.270	3.395	GP STUD M6 x 16mm (Inside)
2	16.520	3.395	GP STUD M6 x 16mm (Inside)
3	31.270	3.395	GP STUD M6 x 16mm (Inside)
4	40.520	3.395	GP STUD M6 x 16mm (Inside)

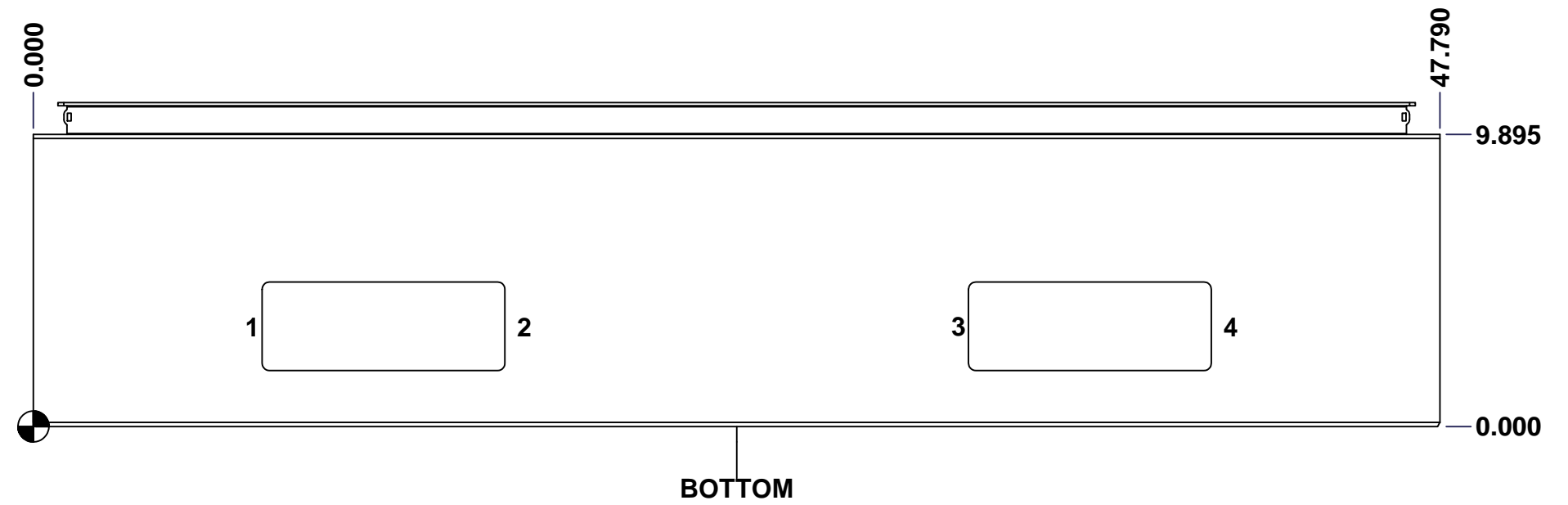

	Description	Status	
	5500SSDD 60" x 48" x 10" Body	Released	
	Part Number Numéro Pièce	Rev.	
	5500SSDD604810B	0	4 / 7

This drawing is confidential and must not be reproduced or used without the consent of EXM

Ce dessin est confidentiel et ne doit pas être reproduit ou utilisé sans le consentement de EXM

STANDARD FEATURES ARE NOT LISTED IN THIS HOLE TABLE			
HOLE TABLE - LEFT VIEW (CUSTOM FEATURE ONLY)			
CUT-OUT	XDIM	YDIM	DESCRIPTION
1	8.395	3.270	GND STUD M6 x 16mm (Inside)

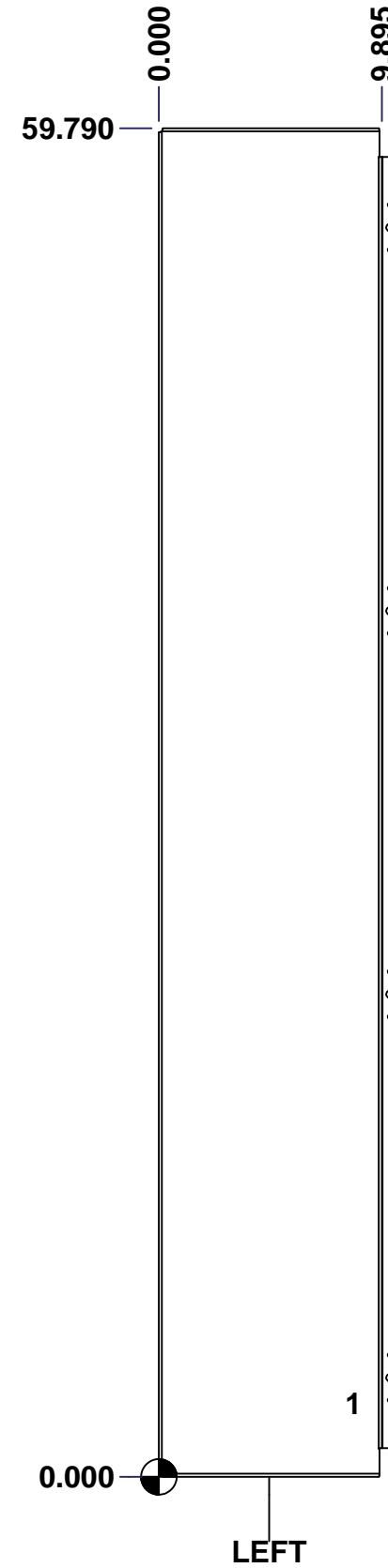

	Description	Status	
	5500SSDD 60" x 48" x 10" Body	Released	
	Part Number Numéro Pièce	Rev.	5
	5500SSDD604810B	0	7

This drawing is confidential and must not be reproduced or used without the consent of EXM

Ce dessin est confidentiel et ne doit pas être reproduit ou utilisé sans le consentement de EXM

STANDARD FEATURES ARE NOT LISTED IN THIS HOLE TABLE

HOLE TABLE - BACK VIEW (CUSTOM FEATURE ONLY)

CUT-OUT	XDIM	YDIM	DESCRIPTION
1	2.770	2.770	IP STUD M10 x 40mm (Inside)
2	45.020	2.770	IP STUD M10 x 40mm (Inside)
3	2.770	29.895	IP STUD M10 x 40mm (Inside)
4	45.020	29.895	IP STUD M10 x 40mm (Inside)
5	2.770	57.020	IP STUD M10 x 40mm (Inside)
6	45.020	57.020	IP STUD M10 x 40mm (Inside)
7	23.895	2.770	IP STUD M10 x 40mm (Inside)
8	23.895	57.020	IP STUD M10 x 40mm (Inside)

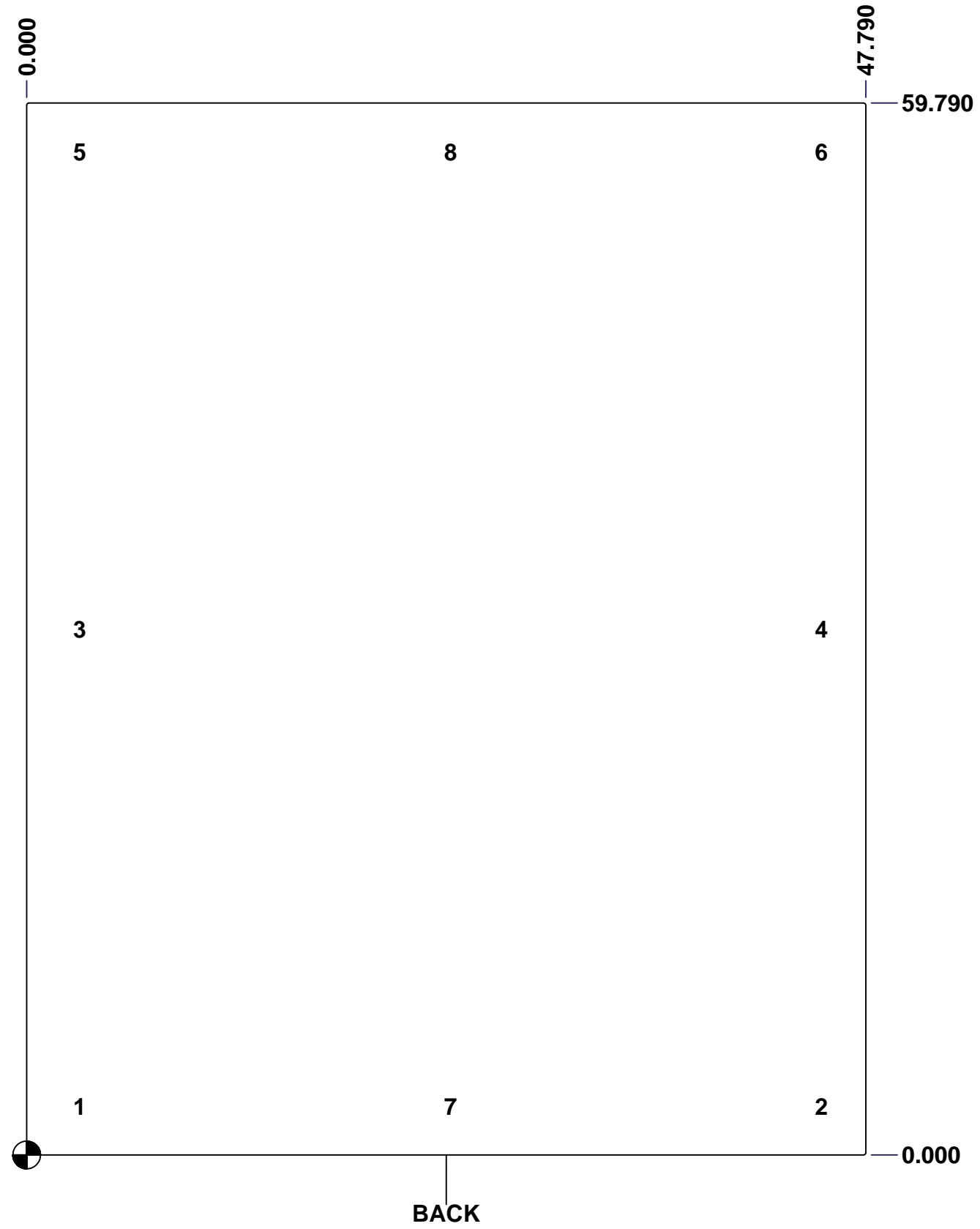

	Description	Status
	5500SSDD 60" x 48" x 10" Body	Released
	Part Number Numéro Pièce	Rev.
	5500SSDD604810B	0
		6 / 7

This drawing is confidential and must not be reproduced or used without the consent of EXM

Ce dessin est confidentiel et ne doit pas être reproduit ou utilisé sans le consentement de EXM

No.	Revisions	Date	By/Par

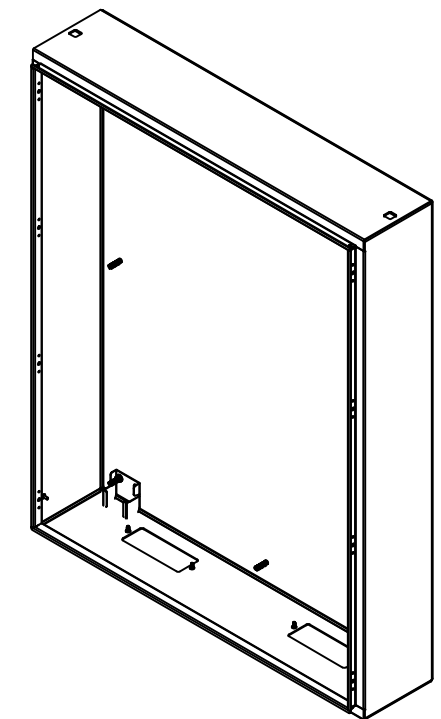

Isometric View



Qty	Part Number	Rev	Description
6	STK-Q-16040	0	Stud M6 x 10mm Stainless Steel
2	STK-Q-16085	0	Ground Stud M6 x 16mm Stainless Steel
6	STK-Q-07220	1	M6 Nylon Insert Lock Nut
4	STK-Q-16095	0	M6 x 16mm Stainless Steel Ground Stud
2	STK-Q-07320	0	Flange Lock Nut M10
2	STK-Q-07618	1	5500 Series Inner Panel Support Bracket
8	STK-Q-16120	0	Stud M10 x 40mm Stainless Steel
1	5500SSDD604810BT-P	0	5500SSDD 48" x 10" Bottom Part
1	5500SSDD604810T-P	0	5500SSDD 48" x 10" Top Part
1	5500SSDD604810RS-P	0	5500SSDD 60" x 48" Right Part
1	5500SSDD604810LS-P	0	5500SSDD 60" x 48" Left Part
1	5500SSDD604810B-P	0	5500SSDD 60" x 48" Back Part
2	CR400SS_17.5	0	Commercial Roll Stainless Steel (17.5in long)
	Part Number	Rev	Description
Parts List			

Tél: (450) 979-4373 Fax: (450) 979-4626 www.exmweb.com		Flatness Aplatissement Max 3.0mm Projection
Customer Client	Date	
Drawn By Dessiné Par	BoxCad: BoxCad	Date 10-Mar-16
Material Matière	12 Ga Stainless Steel 304 (2.5mm)	
Color Couleur	Unpainted	Finish Fini Brushed
Description	5500SSDD 60" x 48" x 10" Body	
Part Number Numéro Pièce	Rev. 0	2
5500SSDD604810B		2

This drawing is confidential and must not be reproduced or used without the consent of EXM

Ce dessin est confidentiel et ne doit pas être reproduit ou utilisé sans le consentement de EXM

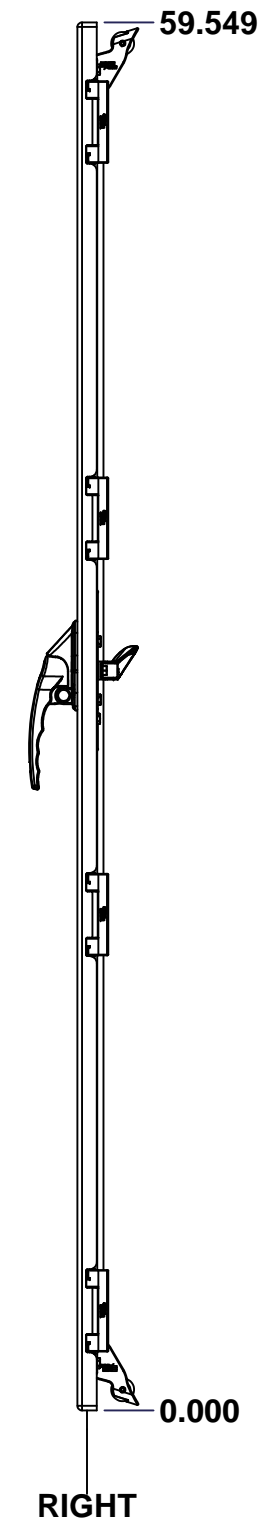
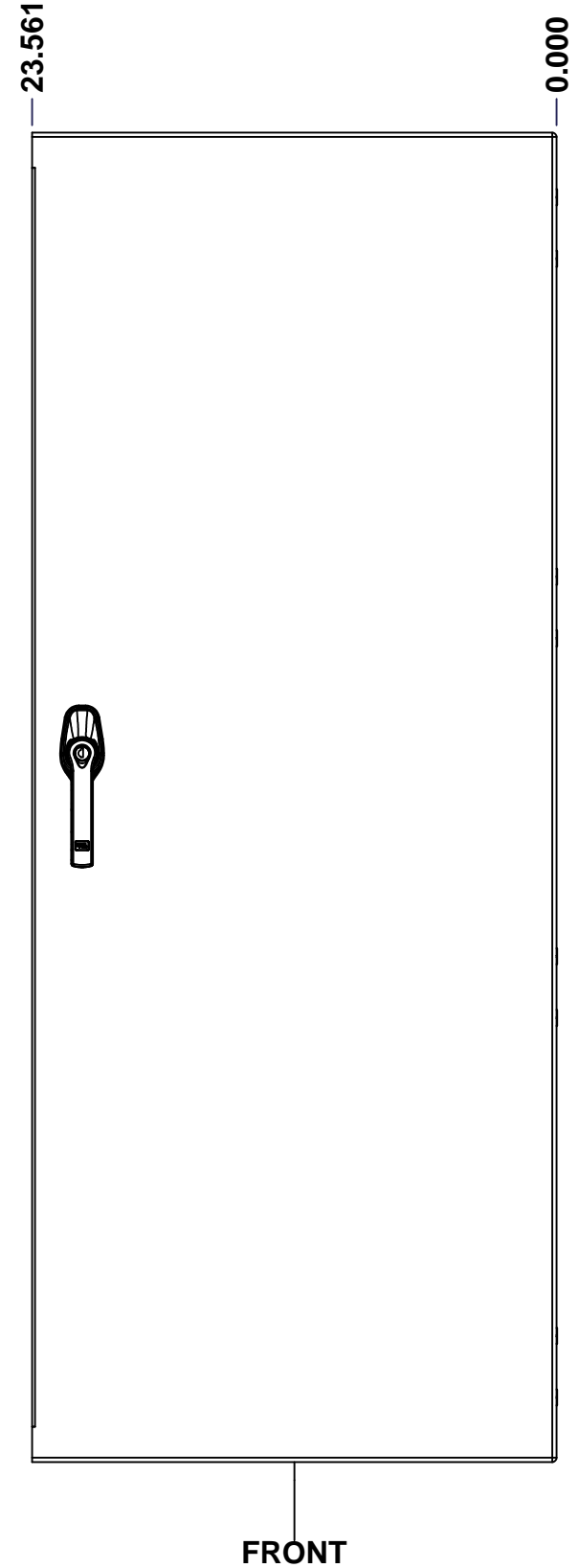
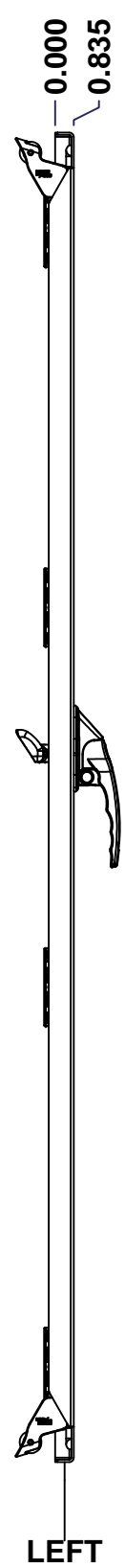
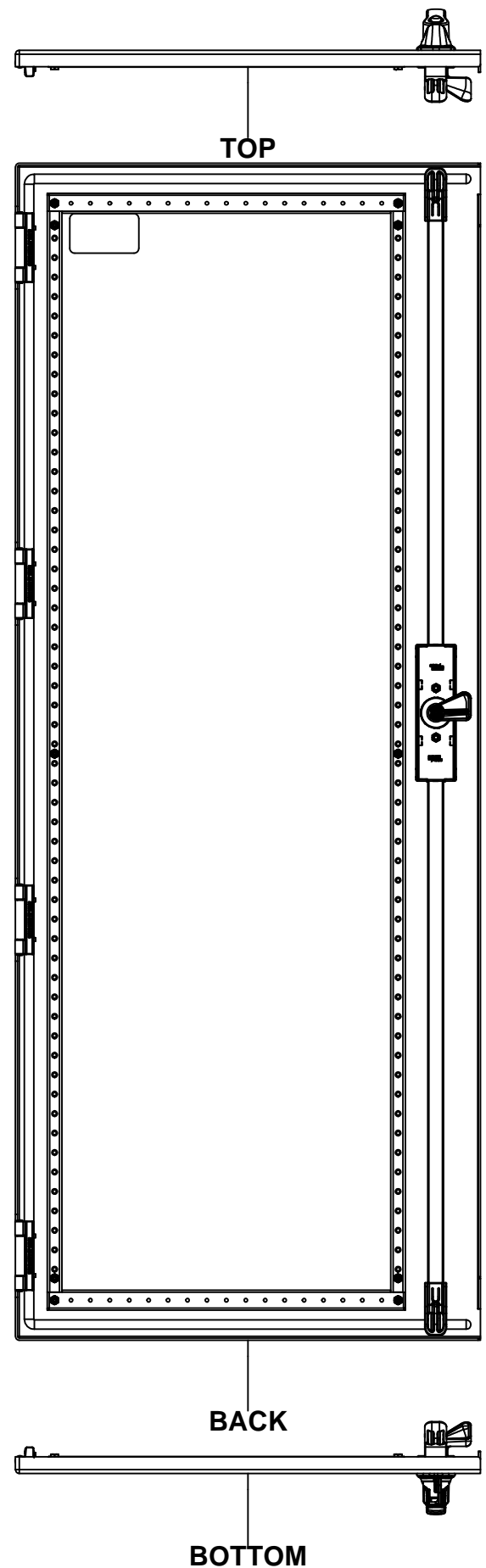

No.	Revisions	Date	By/Par

Isometric View

		Flatness Aplatissement Max 3.0mm	
		Projection 	
Customer Client		Date	
Drawn By Dessiné Par BoxCad: BoxCad		Date 10-Mar-16	
Material Matière 12 Ga Stainless Steel 304 (2.5mm)		Color Couleur Unpainted	
Description 5500SSDD 60" x 48" Lock Door		Finish Fini Brushed	
Part Number Numéro Pièce 5500SSDD604810LD		Detail Rev.	
SEE BILL OF MATERIAL ON LAST PAGE		Rev. 0	1 / 3

This drawing is confidential and must not be reproduced or used without the consent of EXM

Ce dessin est confidentiel et ne doit pas être reproduit ou utilisé sans le consentement de EXM

STANDARD FEATURES ARE NOT LISTED IN THIS HOLE TABLE

HOLE TABLE - FRONT VIEW (CUSTOM FEATURE ONLY)

CUT-OUT	XDIM	YDIM	DESCRIPTION
1	1.983	2.028	STUD M6 x 18mm (Inside)
2	1.983	29.675	STUD M6 x 18mm (Inside)
3	1.983	57.521	STUD M6 x 18mm (Inside)
4	1.983	3.139	STUD M6 x 18mm (Inside)
5	1.983	56.409	STUD M6 x 18mm (Inside)
6	19.390	2.028	STUD M6 x 18mm (Inside)
7	19.390	29.675	STUD M6 x 18mm (Inside)
8	19.390	57.521	STUD M6 x 18mm (Inside)
9	19.390	3.139	STUD M6 x 18mm (Inside)
10	19.390	56.409	STUD M6 x 18mm (Inside)
11	21.311	6.118	STUD M6 x 18mm (Inside)
12	21.311	53.430	STUD M6 x 18mm (Inside)

13	21.311	31.743	HANDLE 885 ESL2A-APHKSS @ 0.0°

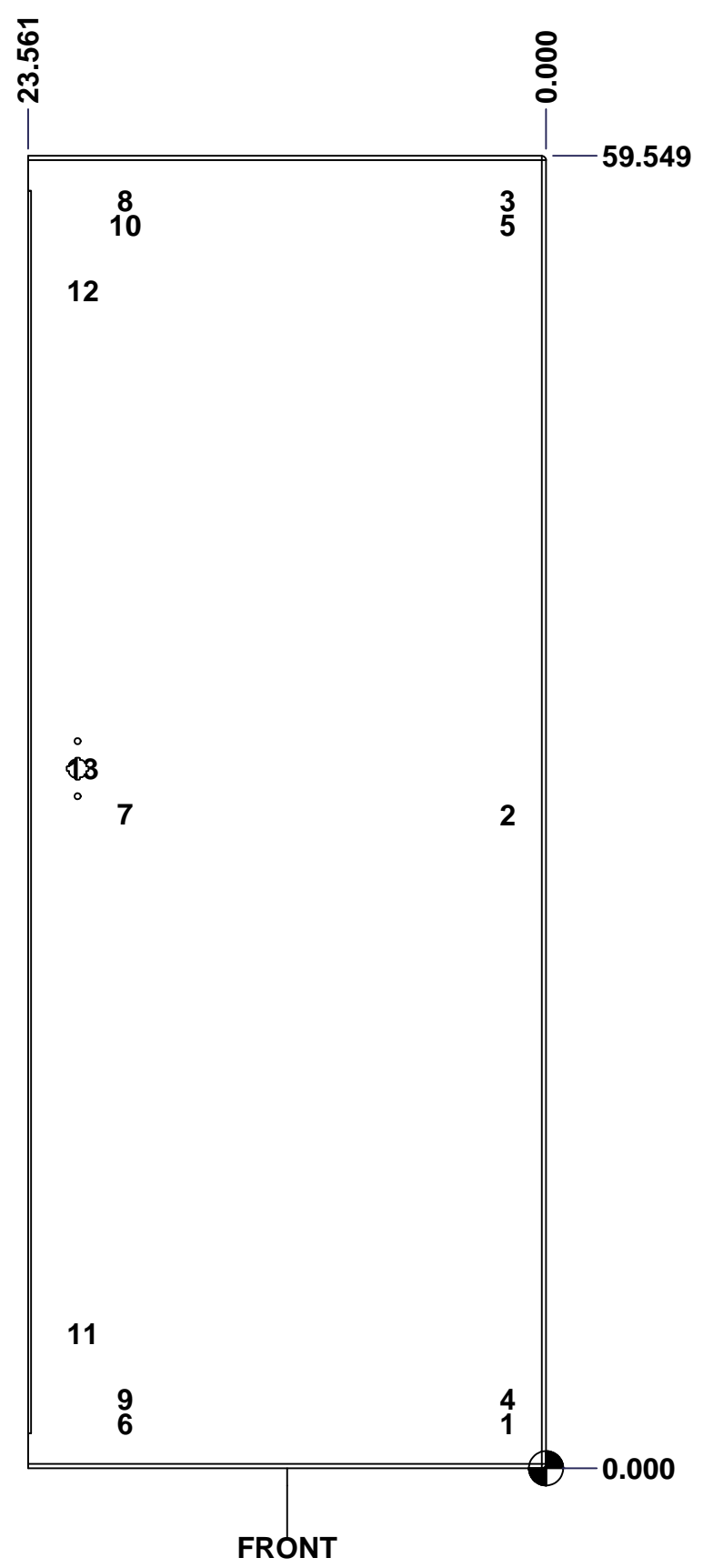

FRONT

	Description	Status
	5500SSDD 60" x 48" Lock Door	(NULL)
	Part Number Numéro Pièce	Rev.
	5500SSDD604810LD	0
		2
		3

This drawing is confidential and must not be reproduced or used without the consent of EXM

Ce dessin est confidentiel et ne doit pas être reproduit ou utilisé sans le consentement de EXM

No.	Revisions	Date	By/Par

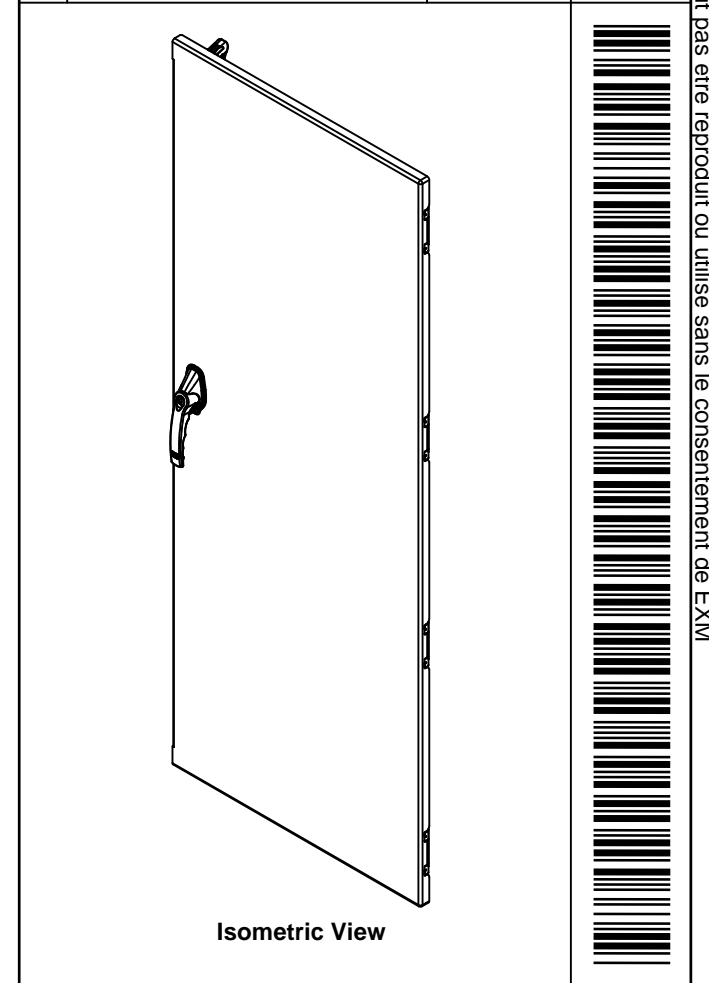

Qty	Part Name	Rev	Description
1	STK-Q-47521	1	5500 DDS Lower Closing Bar 60"
1	STK-Q-47511	1	5500 DDS Upper Closing Bar 60"
1	STK-A-03986-36	2	Gearbox Counterclockwise Assembly (36.0mm)
1	885ESL2A-APHKSS	7	885 ESL2A-APHKSS - Stainless Steel L-Handle Padlockable Assy
1	STK-S-00100	0	3.5" x 2" Silver Milar Flexcon Sticker
1	5500SSDD604810LDG	0	5500SSDD 60" x 48" Lock Door Gasket
1	STK-K-10700	3	5500 DDS - Door Stiffener Assembly
2	STK-Q-16410	0	Guide Stud - Largel (No Paint Cap Required)
10	STK-Q-16070	1	Stud M6 x 18mm Stainless steel
1	5500SSDD604810LD-P	0	5500SSDD 60" x 48" Lock Door Part
4	STK-K-09870	7	Cabinet Hinge with Captive Pins
2	STK-A-90025	0	9500 - Cabinet Closing Bar End (Large)
Parts List			

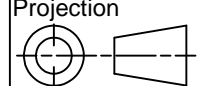
 Tél: (450) 979-4373 Fax: (450) 979-4626 www.exmweb.com		Flatness Aplatissement Max 3.0mm Projection 
Customer Client	Date	Date 10-Mar-16
Drawn By Dessiné Par	BoxCad: BoxCad	
Material Matière	12 Ga Stainless Steel 304 (2.5mm)	
Color Couleur	Unpainted	Finish Fini Brushed
Description	Detail Rev.	
5500SSDD 60" x 48" Lock Door		
Part Number Numéro Pièce	Rev.	3
5500SSDD604810LD	0	3

This drawing is confidential and must not be reproduced or used without the consent of EXM

Ce dessin est confidentiel et ne doit pas être reproduit ou utilisé sans le consentement de EXM

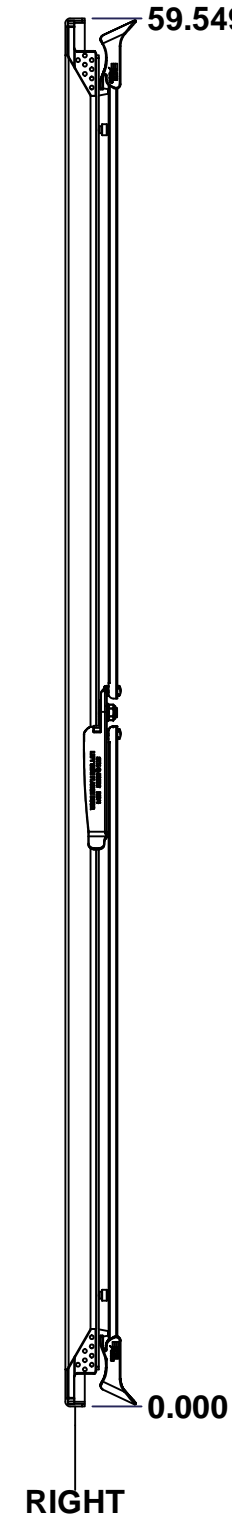
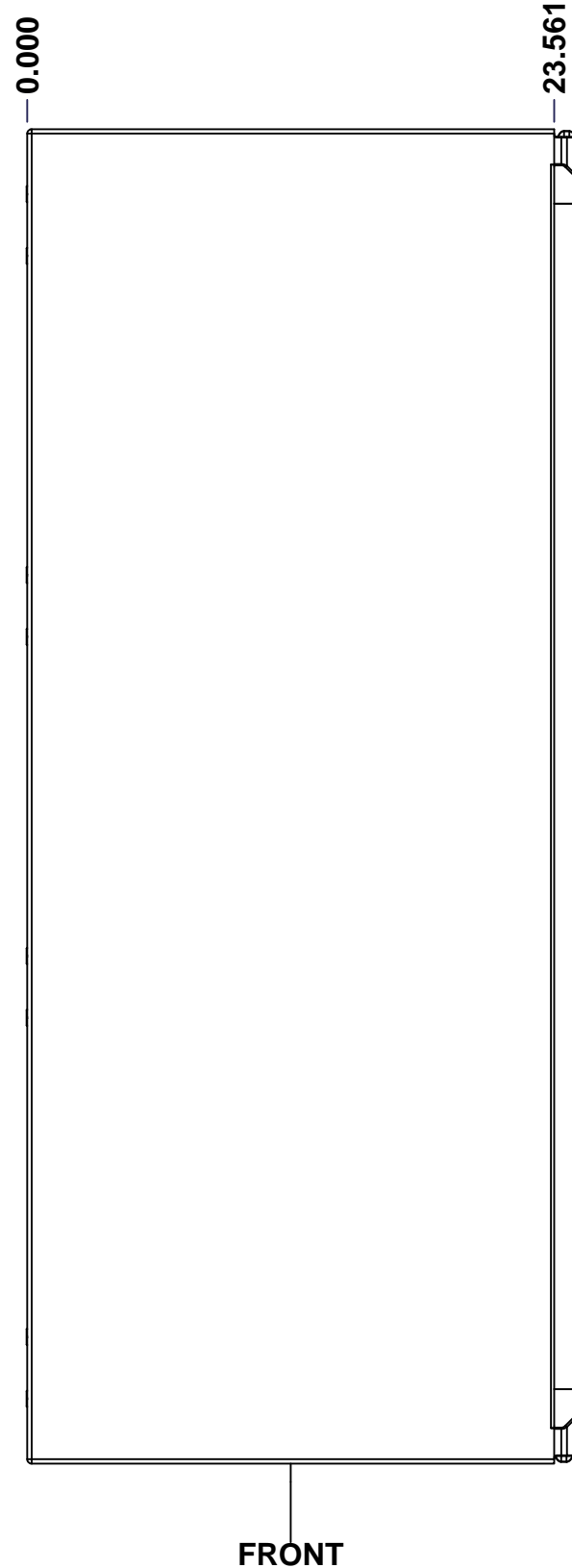
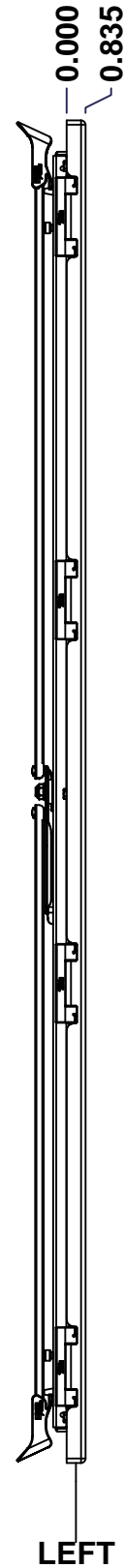
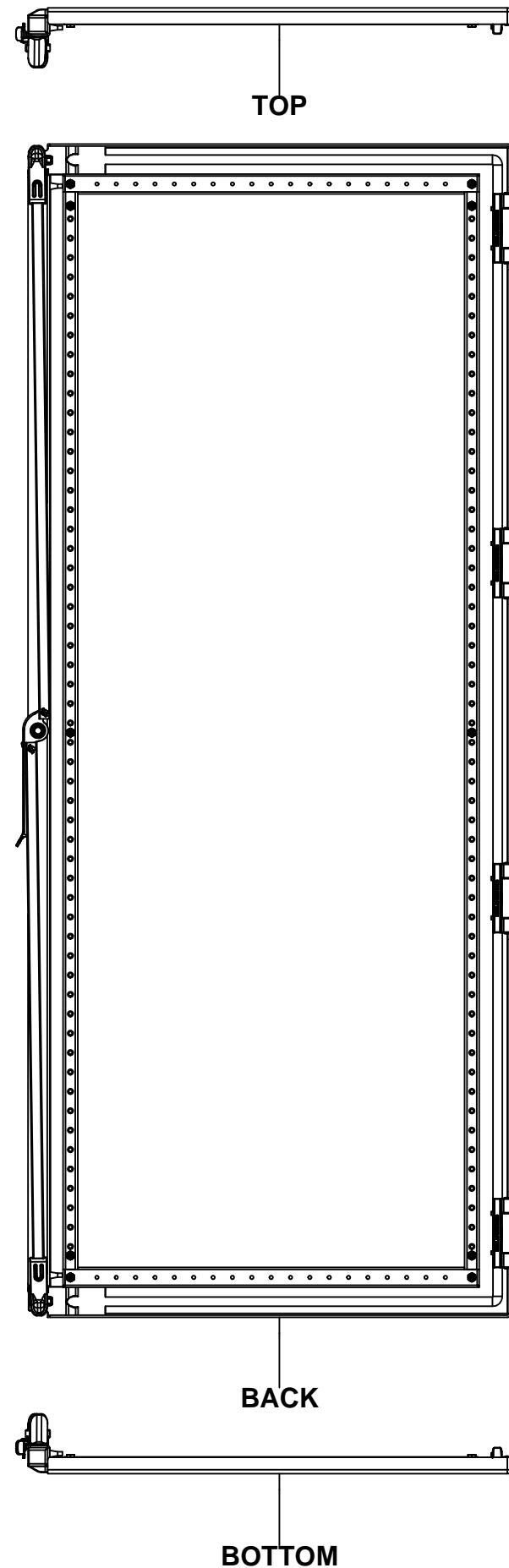

No.	Revisions	Date	By/Par

Isometric View

<p>Tél: (450) 979-4373 Fax: (450) 979-4626 www.exmweb.com</p>		Flatness Aplatissement	
		Max 3.0mm	
Customer Client		Projection	
Date			
Drawn By Dessiné Par	BoxCad: BoxCad	Date	10-Mar-16
Material Matière: 12 Ga Stainless Steel 304 (2.5mm)			
Color Couleur: Unpainted	Finish Fini: Brushed		
Description 5500SSDD 60" x 48" Flange Door		Detail Rev.	
Part Number Numéro Pièce: 5500SSDD604810FD		Rev.	1
		0	3

SEE BILL OF MATERIAL ON LAST PAGE

This drawing is confidential and must not be reproduced or used without the consent of EXM

Ce dessin est confidentiel et ne doit pas être reproduit ou utilisé sans le consentement de EXM

STANDARD FEATURES ARE NOT LISTED IN THIS HOLE TABLE

HOLE TABLE - FRONT VIEW (CUSTOM FEATURE ONLY)

CUT-OUT	XDIM	YDIM	DESCRIPTION
1	2.000	2.028	STUD M6 x 18mm (Inside)
2	2.000	29.675	STUD M6 x 18mm (Inside)
3	2.000	57.521	STUD M6 x 18mm (Inside)
4	2.000	3.139	STUD M6 x 18mm (Inside)
5	2.000	56.409	STUD M6 x 18mm (Inside)
6	22.407	2.028	STUD M6 x 18mm (Inside)
7	22.407	29.675	STUD M6 x 18mm (Inside)
8	22.407	57.521	STUD M6 x 18mm (Inside)
9	22.407	3.139	STUD M6 x 18mm (Inside)
10	22.407	56.409	STUD M6 x 18mm (Inside)
11	24.061	4.774	CLOSING BAR GUIDE (Inside)
12	24.061	54.774	CLOSING BAR GUIDE (Inside)
13	24.061	29.774	STUD M10 x 20mm (Inside)

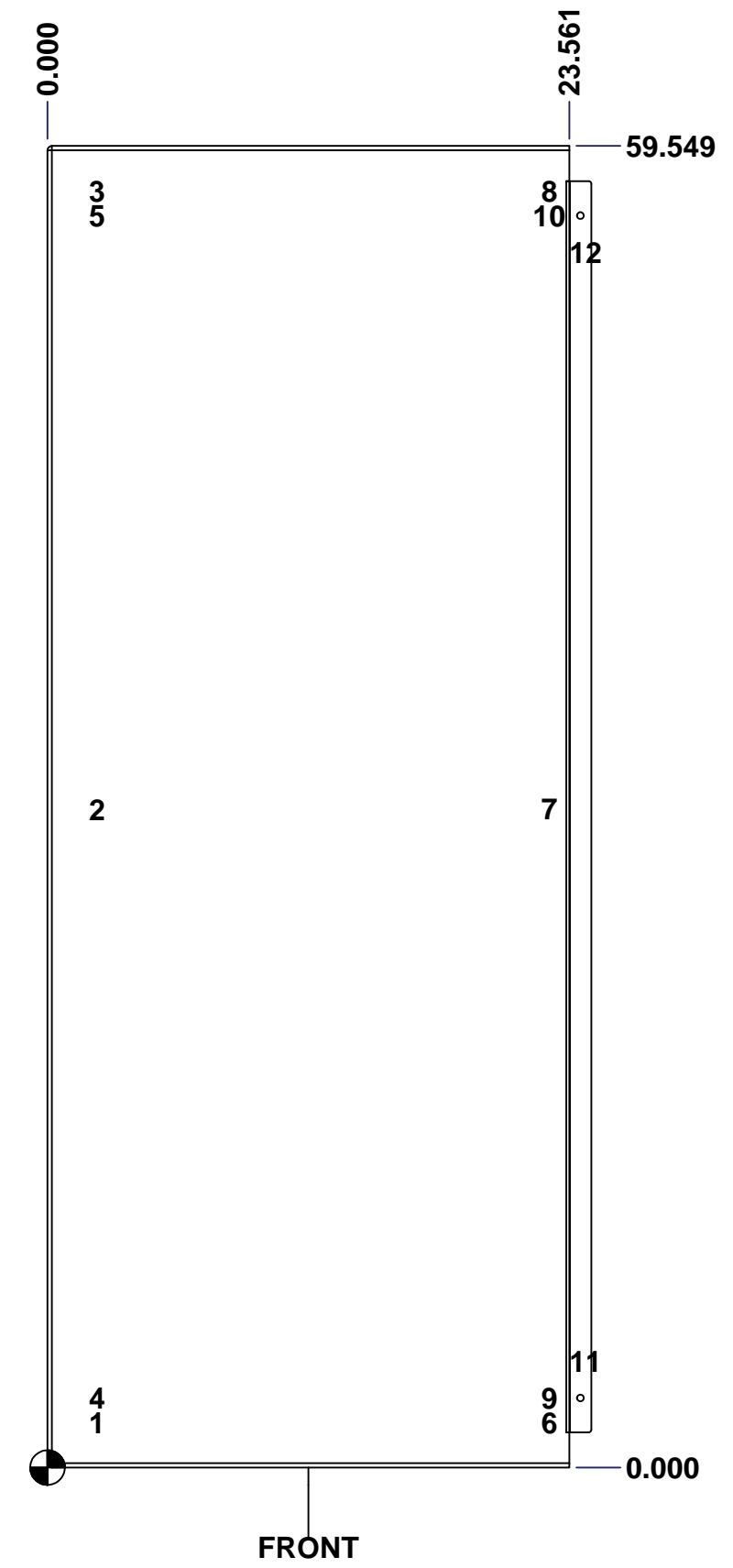

	Description	Status
	5500SSDD 60" x 48" Flange Door	(NULL)
Part Number Numéro Pièce 5500SSDD604810FD	Rev.	2
	0	3

This drawing is confidential and must not be reproduced or used without the consent of EXM

Ce dessin est confidentiel et ne doit pas être reproduit ou utilisé sans le consentement de EXM

No.	Revisions	Date	By/Par

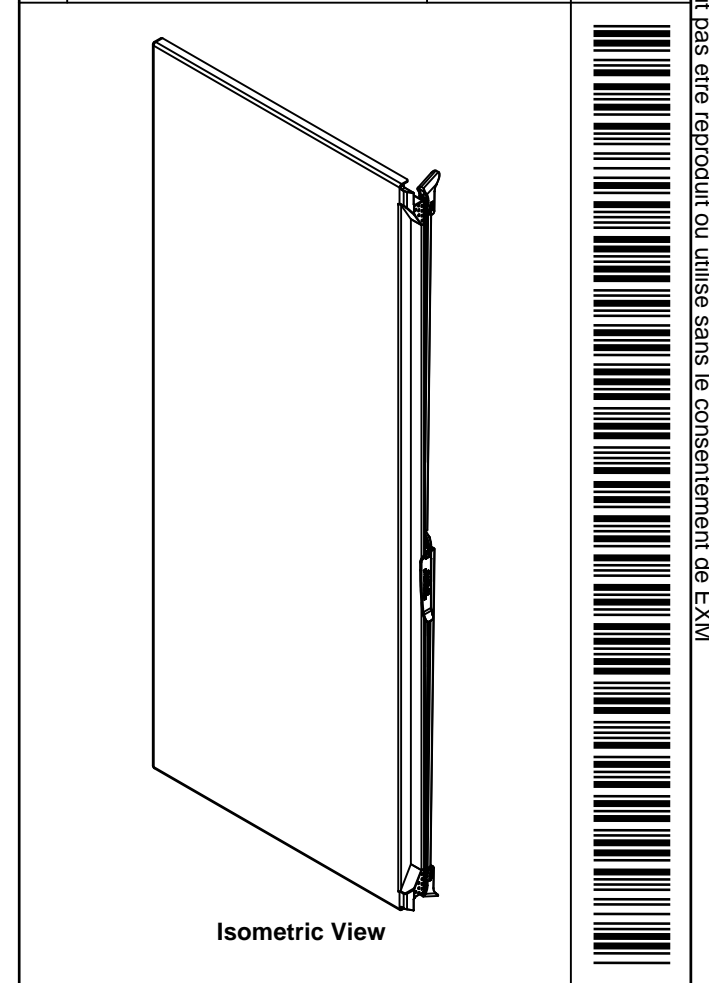

Qty	Part Name	Rev	Description
1	STK-G-03400	0	5500 DD Lower Flange Door Gasket
1	STK-G-03300	0	5500 DD Upper Flange Door Gasket
2	STK-Q-90045	0	Cabinet - Closing Bar End
2	STK-Q-45670-60	2	5500 DDS - Flange Door Closing Bar
1	STK-K-50556	4	9500 DD - Flange Door Handle Assy
1	STK-K-20700	3	5500 DDS - Flange Door Stiffener Assembly
1	STK-Q-16123	1	Stud M10 x 20mm Stainless Steel
1	STK-G-00701	0	1" x 1/4" Self-Adhesive Neoprene Gasket
1	5500SSDD604810FDG	0	5500SSDD 60" x 48" Flange Door Gasket
2	STK-Q-16405	6	Guide Stud - Small (No Paint Cap Required)
10	STK-Q-16070	1	Stud M6 x 18mm Stainless steel
1	5500SSDD604810FD-P	0	5500SSDD 60" x 48" Flange Door Part
4	STK-K-09870	7	Cabinet Hinge with Captive Pins
Qty	Part Name	Rev	Description
Parts List			

Tél: (450) 979-4373
Fax: (450) 979-4626
www.exmweb.com

Flatness
Aplatissement
Max 3.0mm

Projection

Customer Client		Date
Drawn By / Dessiné Par: BoxCad: BoxCad		Date: 10-Mar-16
Material / Matière: 12 Ga Stainless Steel 304 (2.5mm)		
Color / Couleur: Unpainted	Finish / Fini: Brushed	
Description: 5500SSDD 60" x 48" Flange Door		Detail Rev.
Part Number / Numéro Pièce: 5500SSDD604810FD		Rev. 3
		0

This drawing is confidential and must not be reproduced or used without the consent of EXM

Ce dessin est confidentiel et ne doit pas être reproduit ou utilisé sans le consentement de EXM



TOP

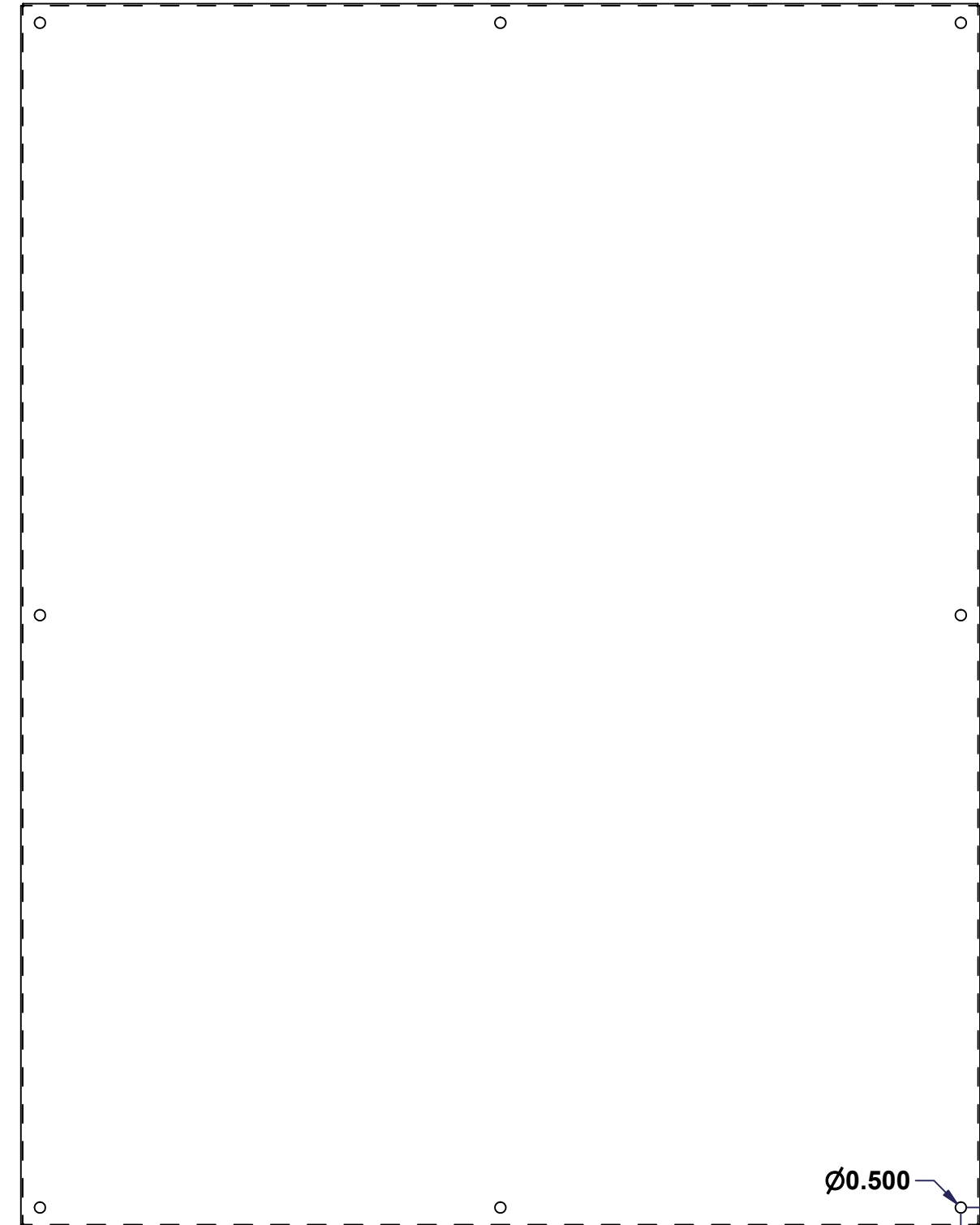

FRONT

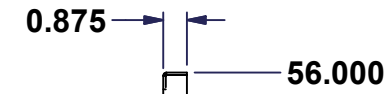

56.000

0.000

RIGHT

SEE BILL OF MATERIAL ON LAST PAGE

No.	Revisions	Date	By/Par

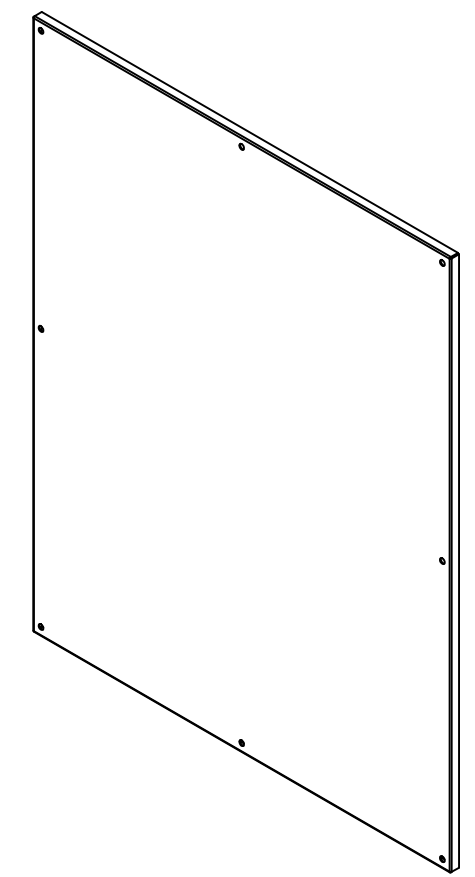

Isometric View



Tél: (450) 979-4373
 Fax: (450) 979-4626
 www.exmweb.com

Flatness
Aplatissement

Max 3.0mm

Projection

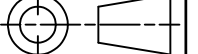

Customer Client	Date
Drawn By / Dessiné Par: BoxCad	Date: 04/11/2009
Material / Matière: 12 Ga Galvanized (2.5mm)	

Color / Couleur: Unpainted	Finish / Fini: Unpainted
----------------------------	--------------------------

Description: 885 SP6048G Inner Panel	Detail Rev.
--------------------------------------	-------------

Part Number / Numéro Pièce: 885SP6048G	Rev. 1	2
	0	

This drawing is confidential and must not be reproduced or used without the consent of EXM

Ce dessin est confidentiel et ne doit pas être reproduit ou utilisé sans le consentement de EXM

No.	Revisions	Date	By/Par

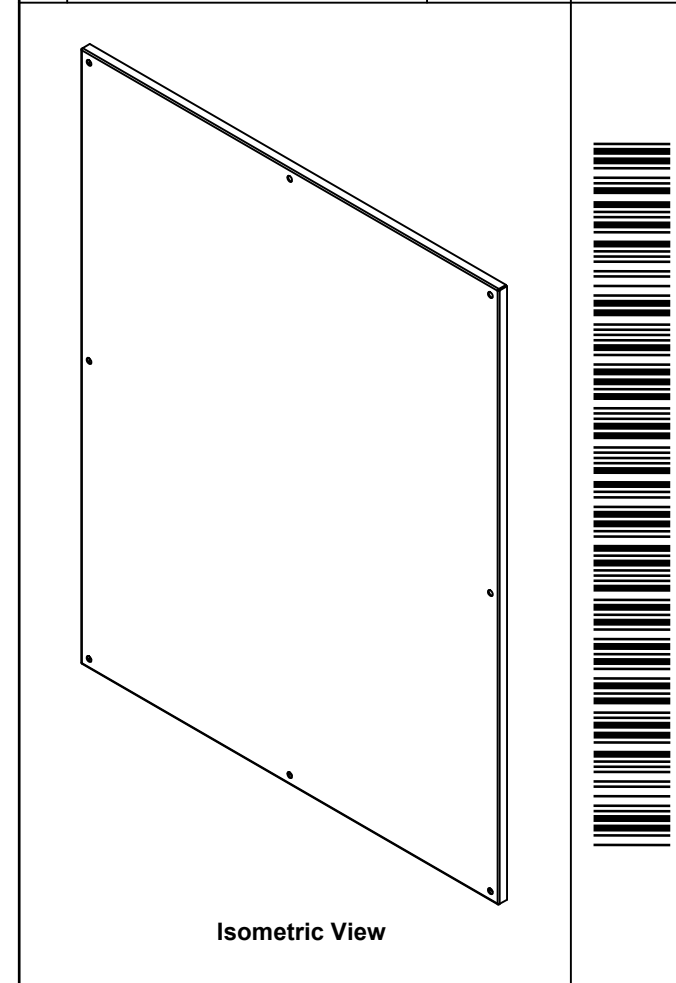

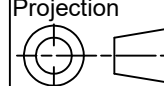
 Tél: (450) 979-4373 Fax: (450) 979-4626 www.exmweb.com		Flatness Aplatissement Max 3.0mm
Customer Client		Projection 
Drawn By Dessiné Par BoxCad		Date 04/11/2009
Material Matière 12 Ga Galvanized (2.5mm)		
Color Couleur Unpainted	Finish Fini Unpainted	
Description 885 SP6048G Inner Panel		Detail Rev.
Part Number Numéro Pièce 885SP6048G		Rev. 2 0

Qty	Part Number	Rev	Description
1	885SP6048G-P	0	885 SP6048G Inner Panel Part
Parts List			