

This drawing is confidential and must not be reproduced or used without the consent of EXM

Ce dessin est confidentiel et ne doit pas être reproduit ou utilisé sans le consentement de EXM

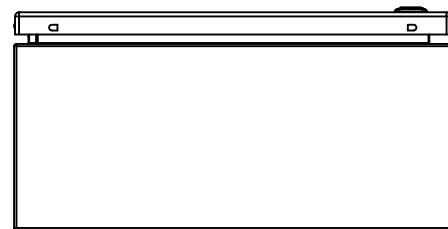

TOP



BACK

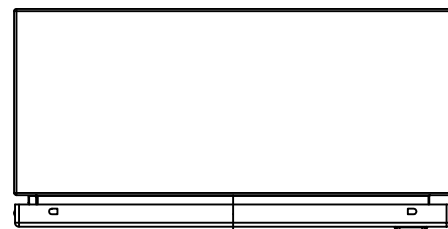

BOTTOM

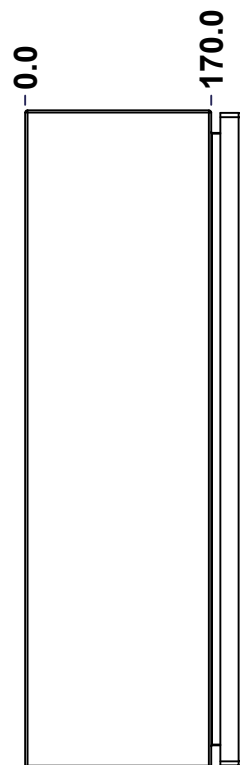

LEFT

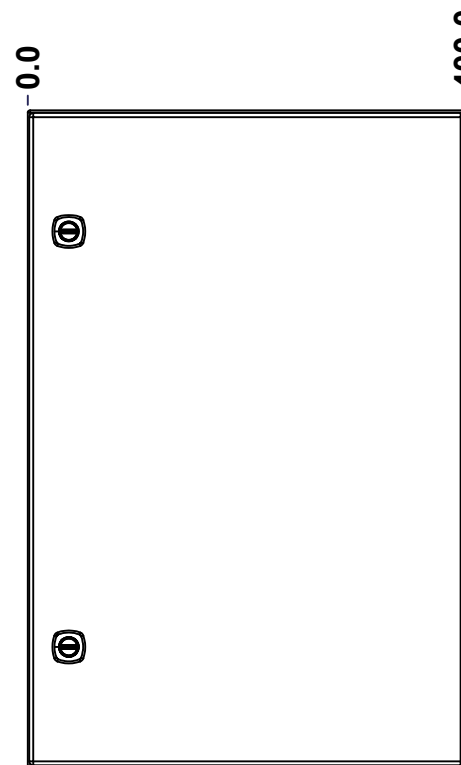

FRONT

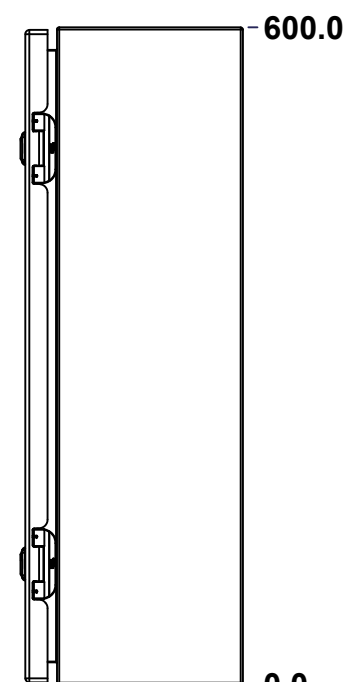

RIGHT

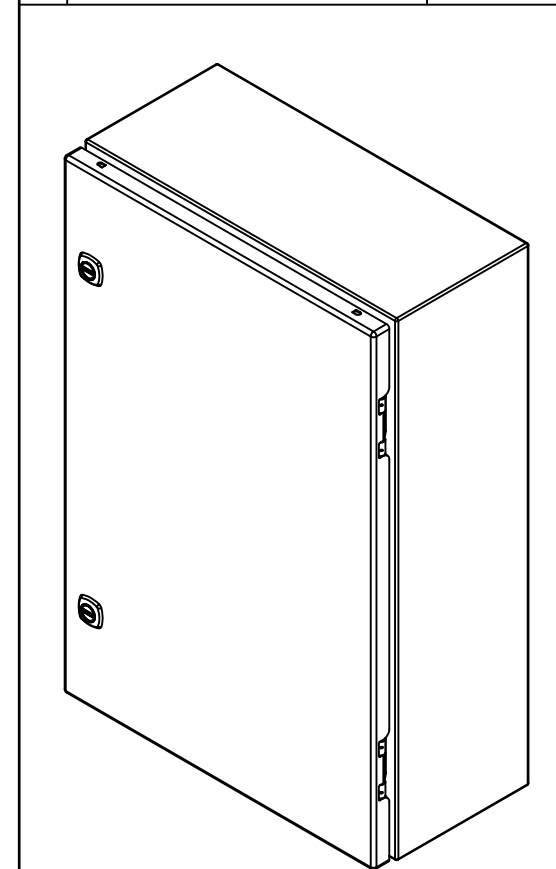

Isometric View

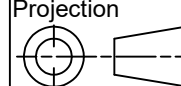

No.	Revisions	Date	By/Par

 Tél: (450) 979-4373 Fax: (450) 979-4626 <a href="http://www.exmweb.com">www.exmweb.com</a>		Flatness Aplatissement Max 3.0mm Projection 
Customer Client	Date	
Drawn By Dessiné Par	BoxCad: BoxCad	Date 13-Aug-14
Material Matière	16 Ga H.R.P. & O. (1.4mm)	
Color Couleur	Light Grey RAL7035	Finish Fin Rough Textured
Description	Detail Rev.	
6412ES 600mm x 400mm x 170mm Assembly		
Part Number Numéro Pièce	Rev.	1 2
<b>6412ES040620</b>	<b>0</b>	

SEE BILL OF MATERIAL ON LAST PAGE

This drawing is confidential and must not be reproduced or used without the consent of EXM

Ce dessin est confidentiel et ne doit pas être reproduit ou utilisé sans le consentement de EXM

NOTE	
ITEM	DESCRIPTION
1	NEMA 4/12 Enclosure
2	C/W Standard ground studs on box and cover
3	C/W Standard door stiffener
4	C/W Standard inner panel (Included)
5	C/W Standard inner panel mounting studs

No.	Revisions	Date	By/Par

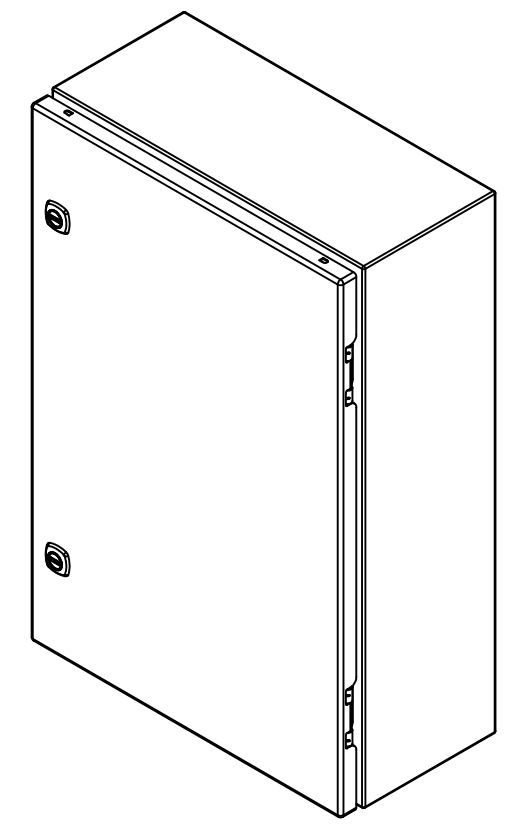

Isometric View



Tél: (450) 979-4373  
 Fax: (450) 979-4626  
[www.exmweb.com](http://www.exmweb.com)

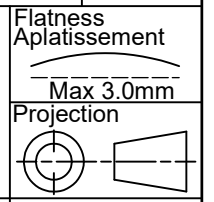

Customer Client	Date
Drawn By / Dessiné Par: BoxCad: BoxCad	Date: 13-Aug-14

Material / Matière: 16 Ga H.R.P. & O. (1.4mm)

Color / Couleur: Light Grey RAL7035  
 Finish / Fini: Rough Textured

Description: 6412ES 600mm x 400mm x 170mm Assembly  
 Detail Rev.

Part Number / Numéro Pièce: **6412ES040620**  
 Rev. 0

PACKING		
ITEM	QTY	DESCRIPTION
Cardboard sleeve	2	Top and Bottom
Cardboard strip	2	Between back of enclosure and inner panel
Plastic bag	1	To protect cover surface and inside gasket
Plastic strap - Black	2	To Squeeze the 2 cardboard sleeve together
Packaging label	1	White label with product number

Qty	Part Number	Rev	Description
1	STK-K-01800	5	5412 ES Accessory Kit
1	886 SP0406ES	0	886 SP - Inner Panel
1	6412ES040620C	0	6412ES 600mm x 400mm Cover
4	STK-Q-07310	2	Flange Lock Nut M8
4	STK-Q-07610	8	M8 Plastic Spacer 22.2mm
1	6412ES040620B	0	6412ES 600mm x 400mm x 170mm Body
2	STK-Q-04050-07	7	M6 x 7mm Hexagon Socket Head Machine Screw with Nyseal
Parts List			

This drawing is confidential and must not be reproduced or used without the consent of EXM

Ce dessin est confidentiel et ne doit pas être reproduit ou utilisé sans le consentement de EXM

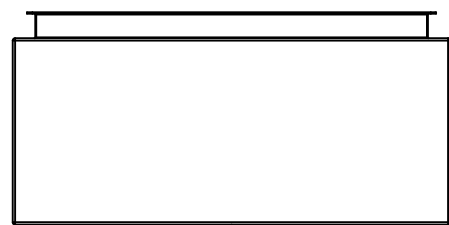

TOP

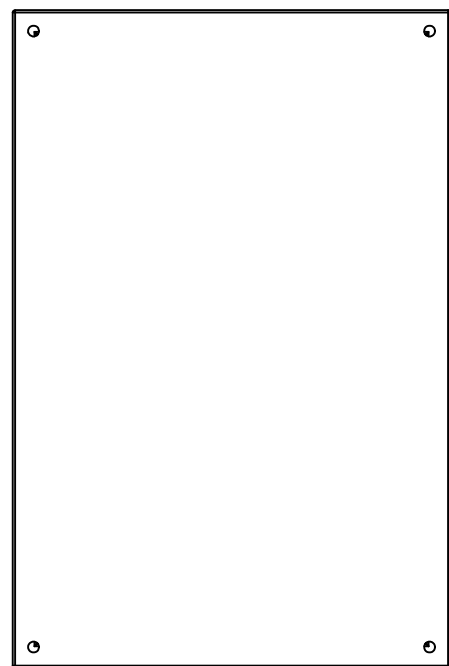

BACK

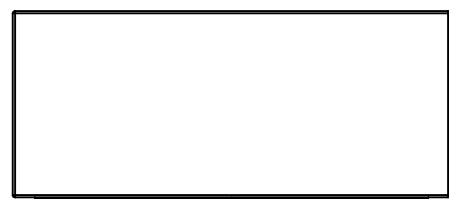

BOTTOM

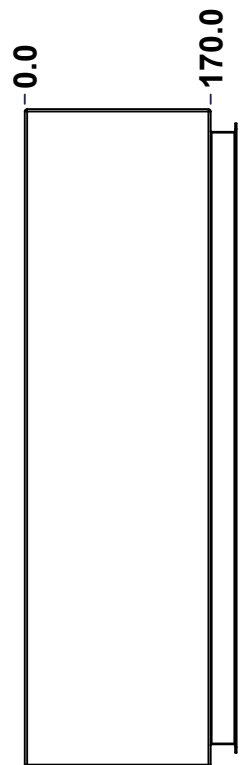

LEFT

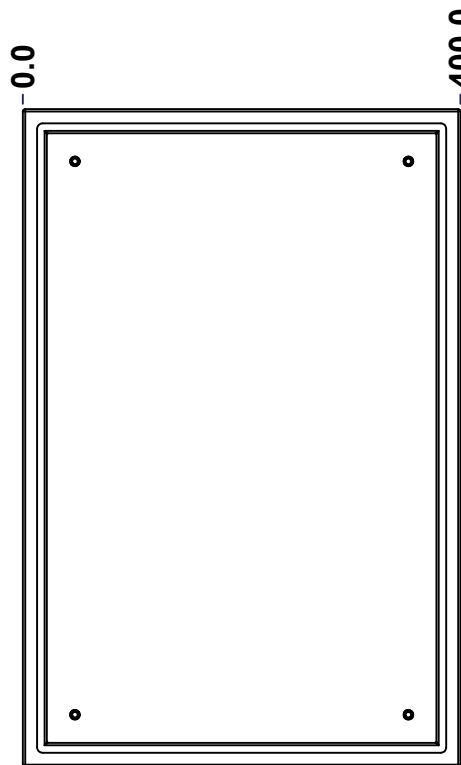

FRONT



RIGHT

No.	Revisions	Date	By/Par

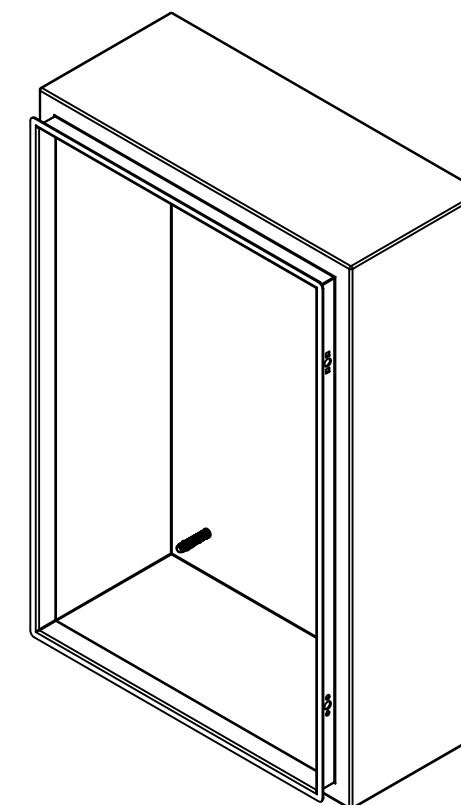

Isometric View



Tél: (450) 979-4373  
 Fax: (450) 979-4626  
[www.exmweb.com](http://www.exmweb.com)

Flatness  
Aplatissement

Max 3.0mm

Projection



Customer Client	Date
Drawn By Dessiné Par BoxCad: BoxCad	Date 13-Aug-14
Material Matière	16 Ga H.R.P. & O. (1.4mm)

Color Couleur	Light Grey RAL7035	Finish Fini	Rough Textured
------------------	--------------------	----------------	-------------------

Description	Detail Rev.
6412ES 600mm x 400mm x 170mm Body	

Part Number Numéro Pièce	Rev.	1
<b>6412ES040620B</b>	<b>0</b>	7

SEE BILL OF MATERIAL ON LAST PAGE

This drawing is confidential and must not be reproduced or used without the consent of EXM

Ce dessin est confidentiel et ne doit pas être reproduit ou utilisé sans le consentement de EXM

<b>STANDARD FEATURES ARE NOT LISTED IN THIS HOLE TABLE</b>			
<b>HOLE TABLE - RIGHT VIEW (CUSTOM FEATURE ONLY)</b>			
CUT-OUT	XDIM	YDIM	DESCRIPTION
1	131.9	50.8	GND STUD M6 x 16mm (Inside)

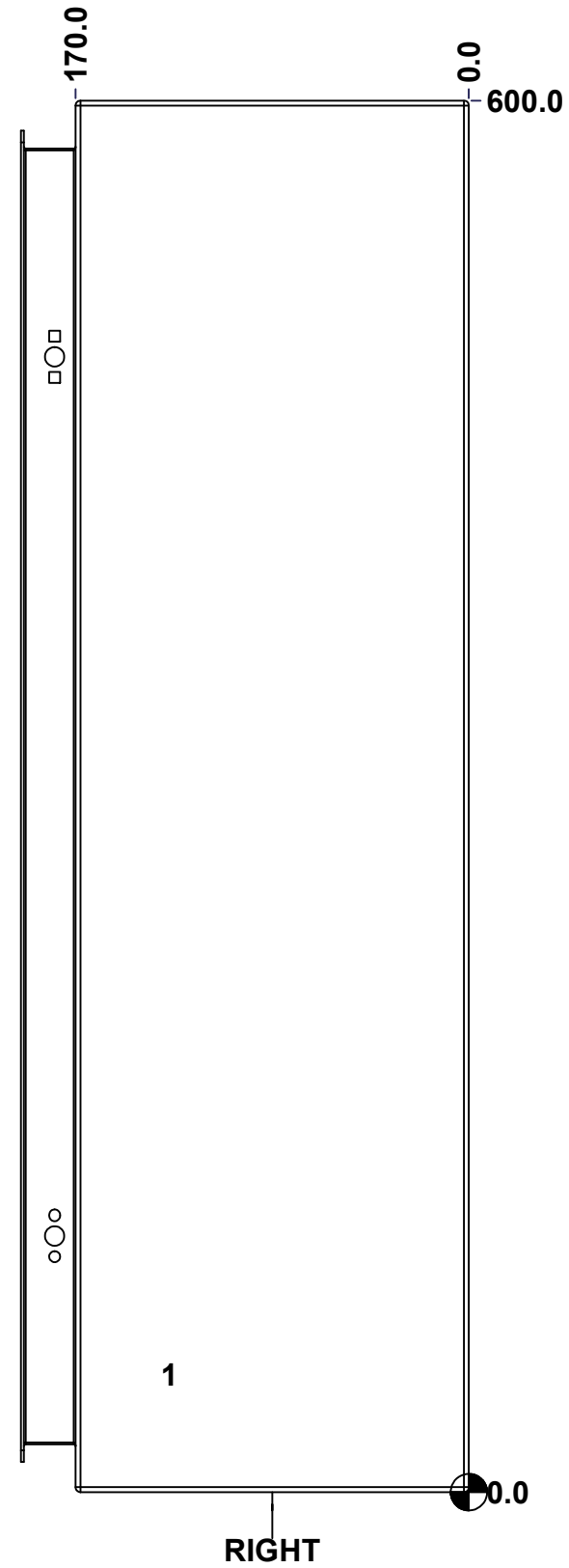

	Description		Status	
	6412ES 600mm x 400mm x 170mm Body			
Part Number Numéro Pièce		Rev.	3 / 7	
<b>6412ES040620B</b>		<b>0</b>		

This drawing is confidential and must not be reproduced or used without the consent of EXM

Ce dessin est confidentiel et ne doit pas être reproduit ou utilisé sans le consentement de EXM

**STANDARD FEATURES ARE NOT LISTED IN THIS HOLE TABLE**

**HOLE TABLE - BACK VIEW (CUSTOM FEATURE ONLY)**

CUT-OUT	XDIM	YDIM	DESCRIPTION
1	47.6	47.6	IP STUD M8 x 35mm (Inside)
2	47.6	552.4	IP STUD M8 x 35mm (Inside)
3	352.4	552.4	IP STUD M8 x 35mm (Inside)
4	352.4	47.6	IP STUD M8 x 35mm (Inside)
-----			
5	381.0	19.1	RND Ø9.9
6	381.0	581.0	RND Ø9.9
7	19.1	581.0	RND Ø9.9
8	19.1	19.1	RND Ø9.9

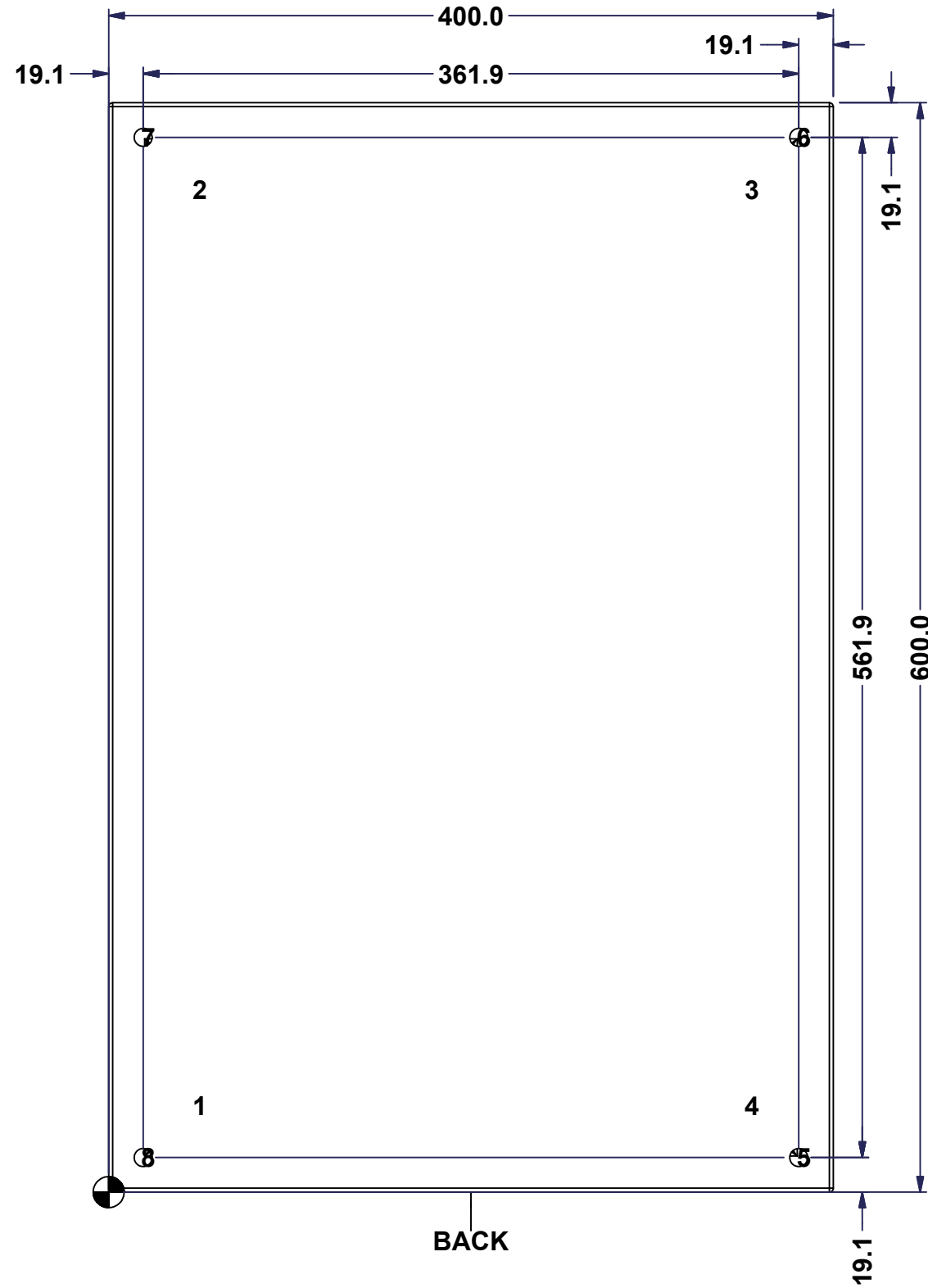

BACK

	Description	Status	
	6412ES 600mm x 400mm x 170mm Body		
	Part Number	Rev.	6
	Numéro Pièce	0	7
	<b>6412ES040620B</b>		

This drawing is confidential and must not be reproduced or used without the consent of EXM

Ce dessin est confidentiel et ne doit pas être reproduit ou utilisé sans le consentement de EXM

No.	Revisions	Date	By/Par

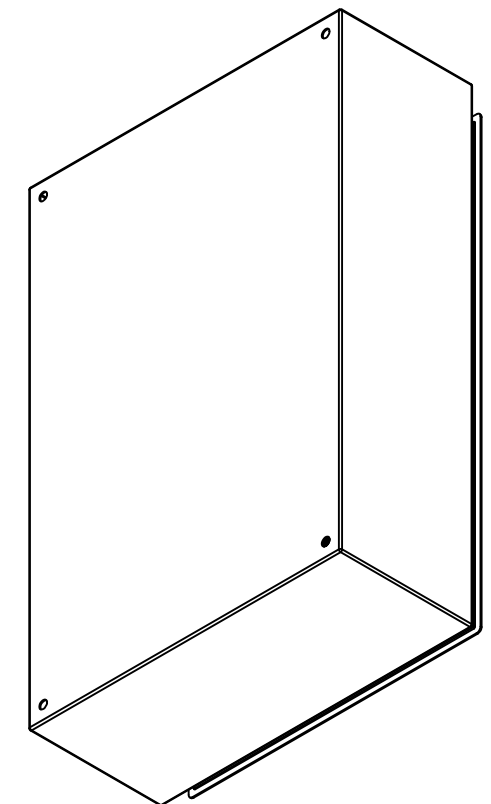

Isometric View

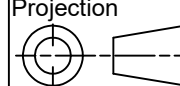

 Tél: (450) 979-4373 Fax: (450) 979-4626 <a href="http://www.exmweb.com">www.exmweb.com</a>		Flatness Aplatissement Max 3.0mm Projection 
Customer Client	Date	
Drawn By Dessiné Par	BoxCad: BoxCad	Date 13-Aug-14
Material Matière	16 Ga H.R.P. & O. (1.4mm)	
Color Couleur	Light Grey RAL7035	Finish Fini Rough Textured
Description	Detail Rev.	
Part Number Numéro Pièce	Rev.	7
<b>6412ES040620B</b>	<b>0</b>	<b>7</b>

Qty	Part Number	Rev	Description
1	STK-Q-16080	0	Ground Stud M6 x 16mm
1	STK-P-03820R	0	Powder Paint (Light Grey / Rough Textured)
4	STK-Q-16005	1	Stud M8 x 35 (No Paint Cap Required)
1	6412ES040620B-P	0	6412ES 600mm x 400mm x 170mm Body Part
Parts List			

This drawing is confidential and must not be reproduced or used without the consent of EXM

Ce dessin est confidentiel et ne doit pas être reproduit ou utilisé sans le consentement de EXM

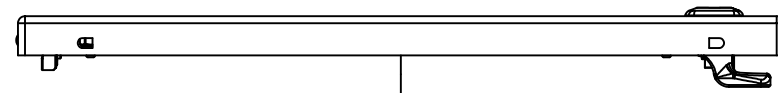

TOP

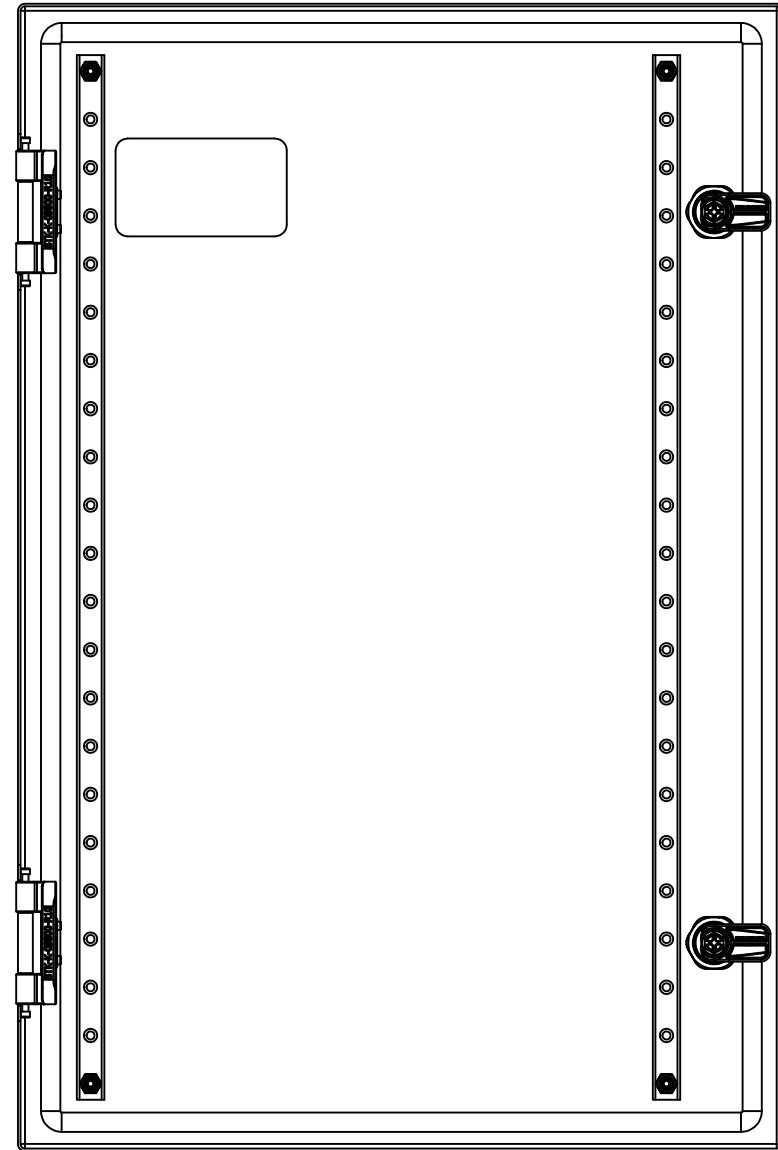

BACK

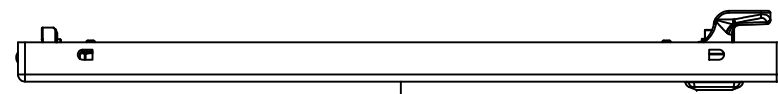

BOTTOM

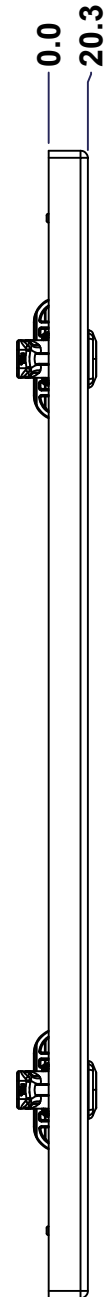

LEFT

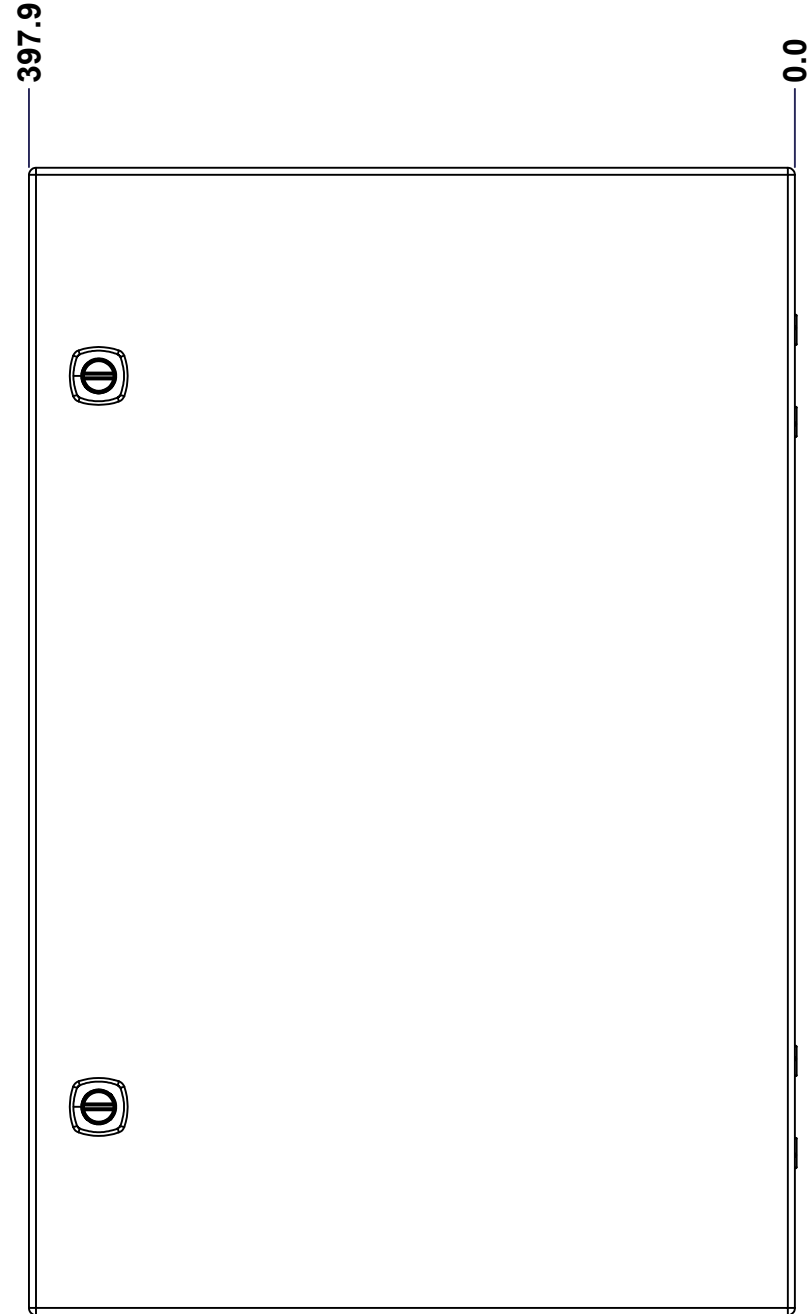

FRONT

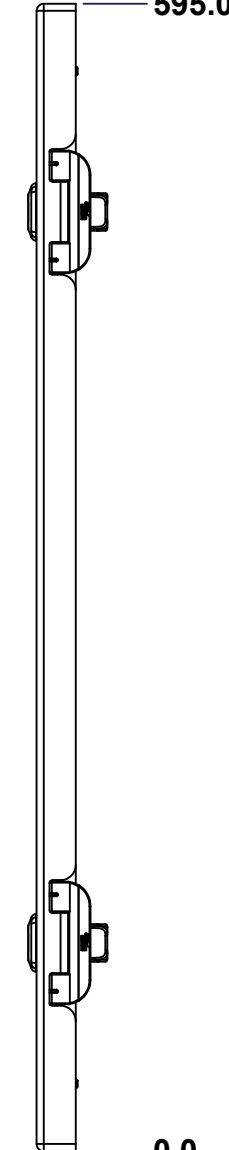

RIGHT

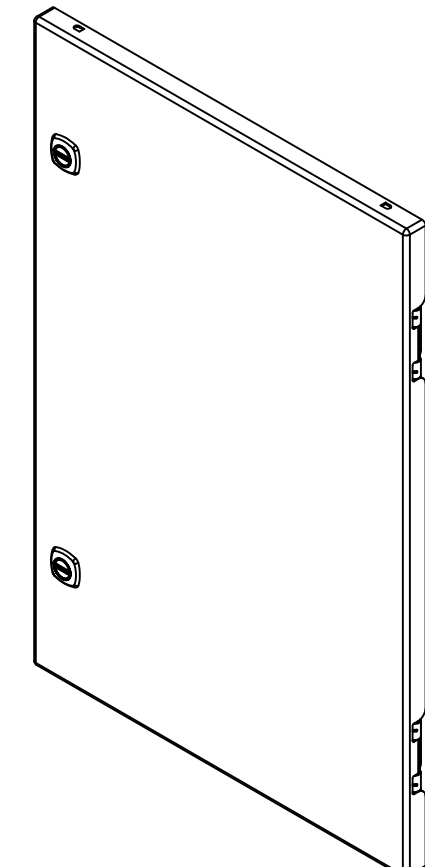

Isometric View

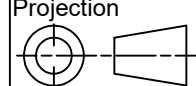

No.	Revisions	Date	By/Par

 Tél: (450) 979-4373 Fax: (450) 979-4626 <a href="http://www.exmweb.com">www.exmweb.com</a>		Flatness Aplatissement Max 3.0mm Projection 
Customer Client	Date	
Drawn By Dessiné Par	BoxCad: BoxCad	Date 13-Aug-14
Material Matière	16 Ga H.R.P. & O. (1.4mm)	
Color Couleur	Light Grey RAL7035	Finish Fini
Description		Detail Rev.
6412ES 600mm x 400mm Cover		
Part Number Numéro Pièce	Rev.	1
<b>6412ES040620C</b>	<b>0</b>	3

SEE BILL OF MATERIAL ON LAST PAGE

This drawing is confidential and must not be reproduced or used without the consent of EXM

Ce dessin est confidentiel et ne doit pas être reproduit ou utilisé sans le consentement de EXM

**STANDARD FEATURES ARE NOT LISTED IN THIS HOLE TABLE**

**HOLE TABLE - FRONT VIEW (CUSTOM FEATURE ONLY)**

CUT-OUT	XDIM	YDIM	DESCRIPTION
1	37.7	35.0	STUD M6 x 18mm (Inside)
2	37.7	560.0	STUD M6 x 18mm (Inside)
3	336.9	560.0	STUD M6 x 18mm (Inside)
4	336.9	35.0	STUD M6 x 18mm (Inside)
-----			
5	95.3	499.7	LABEL_EXM (Inside)
6	361.7	487.0	LOCK 880 SCQ4-SL @ 180.0°
7	361.7	108.0	LOCK 880 SCQ4-SL @ 180.0°

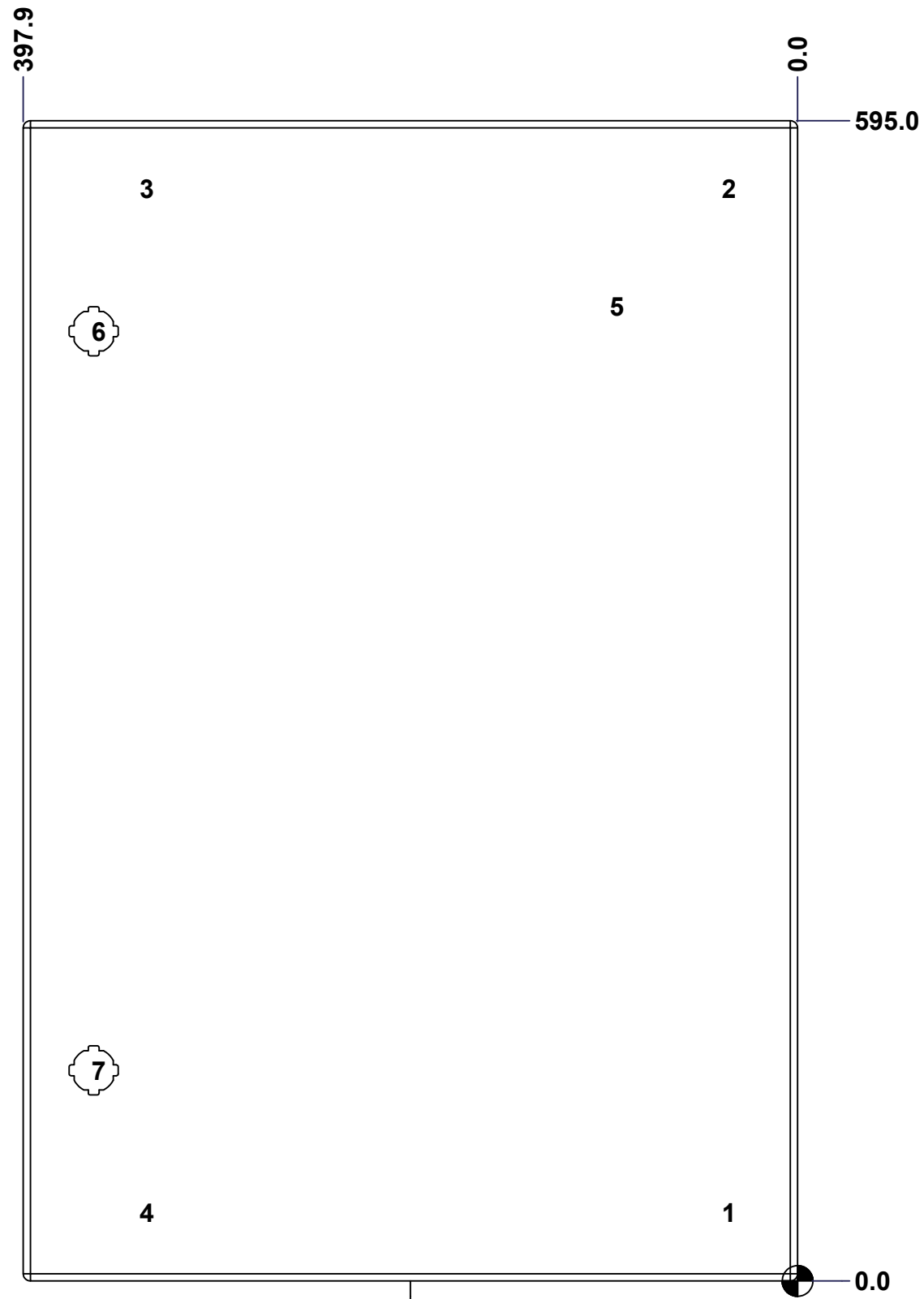

FRONT

	Description	Status
	6412ES 600mm x 400mm Cover	(NULL)
	Part Number Numéro Pièce	Rev.
	<b>6412ES040620C</b>	<b>0</b>
		2
		3



This drawing is confidential and must not be reproduced or used without the consent of EXM

Ce dessin est confidentiel et ne doit pas être reproduit ou utilisé sans le consentement de EXM

No.	Revisions	Date	By/Par

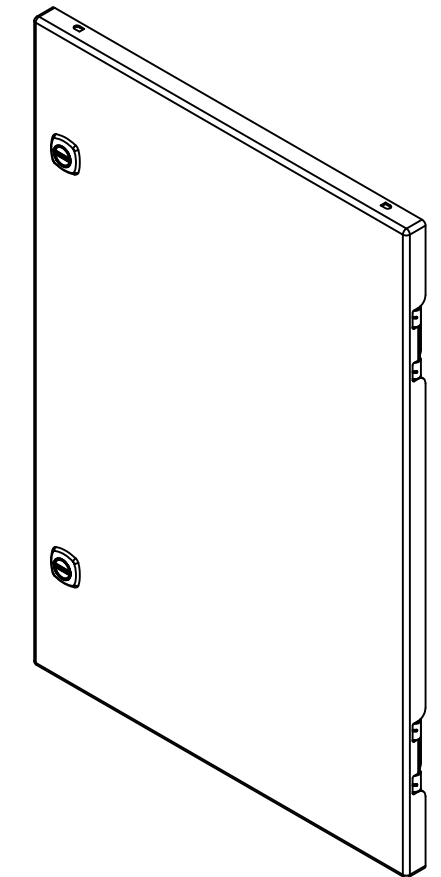

Isometric View



 Tél: (450) 979-4373  
 Fax: (450) 979-4626  
[www.exmweb.com](http://www.exmweb.com)

Flatness Aplatissement  
 Max 3.0mm  
 Projection

Customer Client Date  
 Drawn By Dessiné Par BoxCad: BoxCad Date 13-Aug-14

Material Matière 16 Ga H.R.P. & O. (1.4mm)

Color Couleur Light Grey RAL7035  
 Finish Fini Rough Textured

Description 6412ES 600mm x 400mm Cover  
 Detail Rev.

Part Number Numéro Pièce **6412ES040620C**  
 Rev. 3  
**0** 3

Qty	Part Name	Rev	Description
1	STK-S-00100	0	3.5" x 2" Silver Milar Flexcon Sticker
1	STK-P-03820R	0	Powder Paint (Light Grey / Rough Textured)
2	STK-Q-46020-24	5	5412 ES Vertical Door Stiffener 24"
4	STK-Q-16055	1	M6 x 18mm Stud (No Paint Cap Required)
1	6412ES040620G	0	6412ES 600mm x 400mm Cover Gasket Part
1	6412ES040620C-P	0	6412ES 600mm x 400mm Cover Part
2	STK-K-09800		5412 ES Hinge with 2 Captive Hinge Pins
2	880 SCQ4-SL	6	5412 ES 1/4 Turn Lock
4	STK-Q-07220	1	M6 Nylon Insert Lock Nut
Parts List			

This drawing is confidential and must not be reproduced or used without the consent of EXM

Ce dessin est confidentiel et ne doit pas être reproduit ou utilisé sans le consentement de EXM

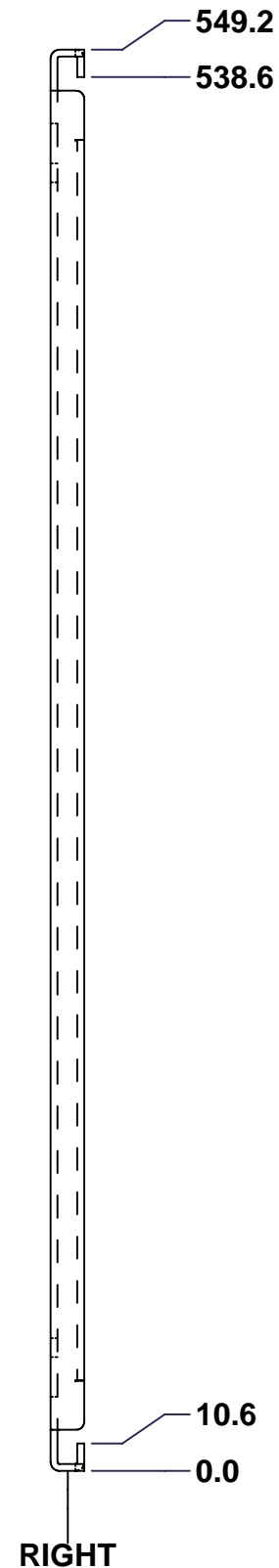
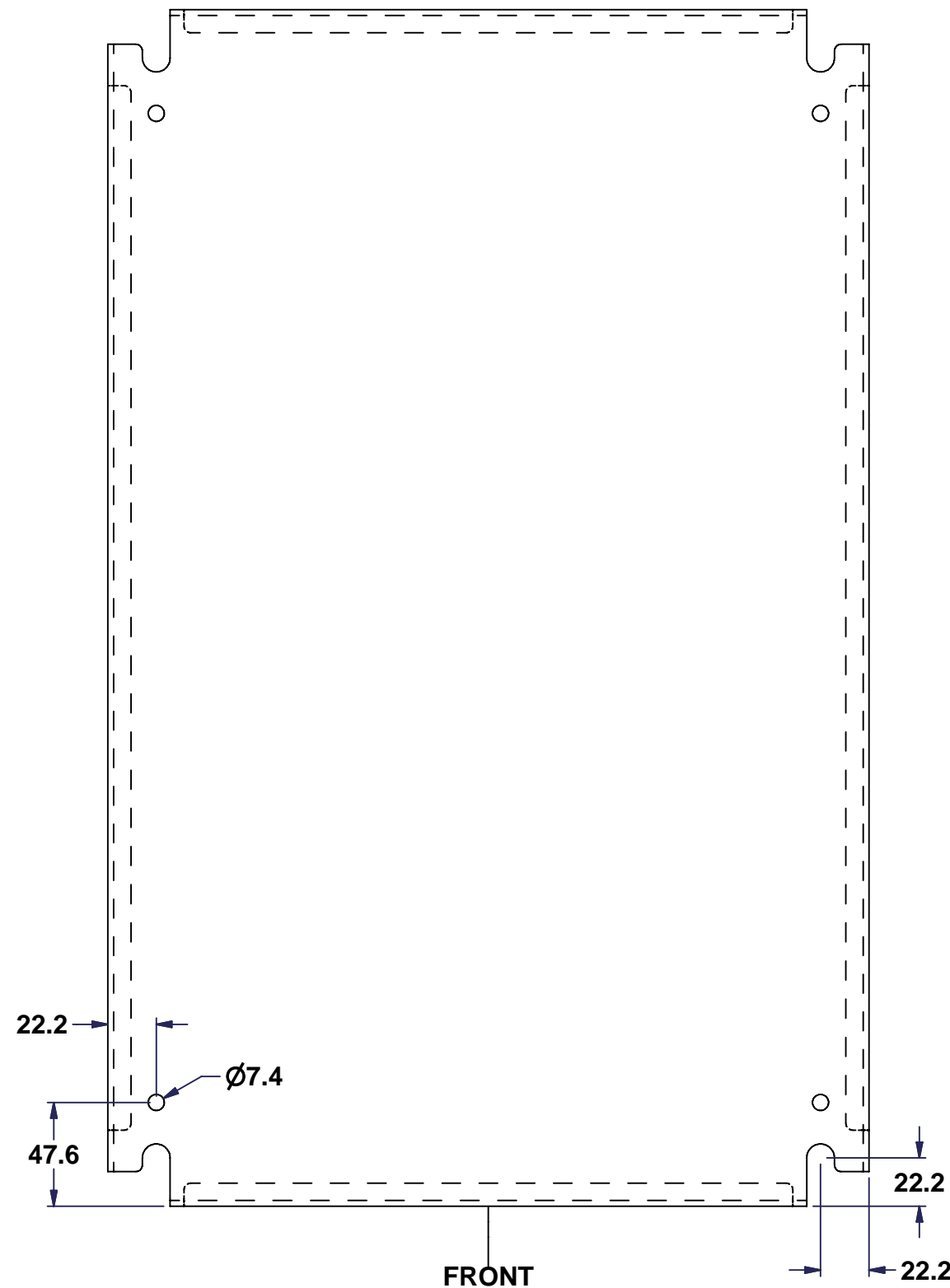
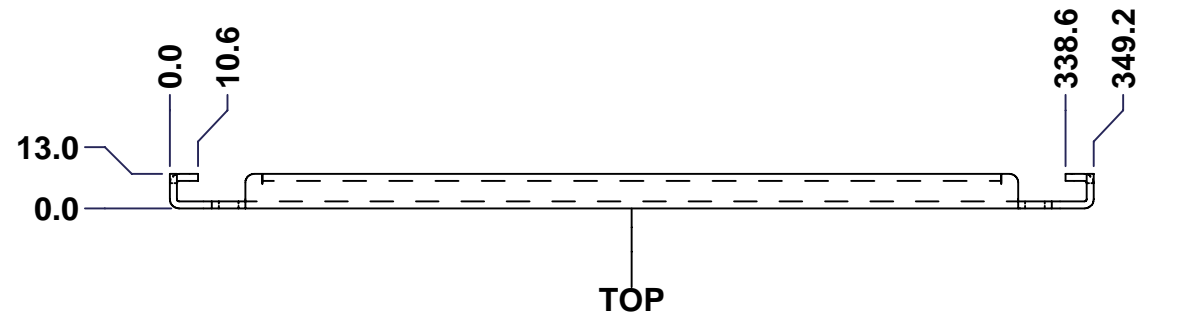

SEE BILL OF MATERIAL ON LAST PAGE

No.	Revisions	Date	By/Par

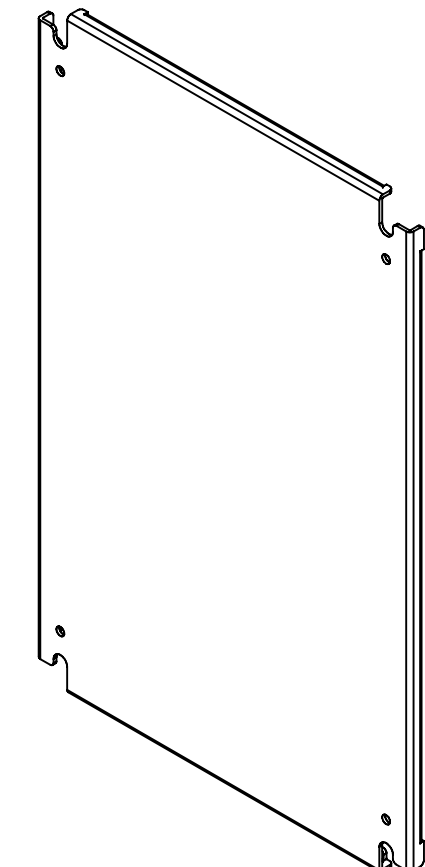

Isometric View



	Flatness Aplatissement Max 3.0mm
	Projection 
Customer Client Drawn By / Dessiné Par: BoxCad Material Matière: 12 Ga Galvanized (2.5mm)	Date: 23/Jan/07
Color Couleur: Unpainted Finish Fini: Unpainted	Description: 886 SP - Inner Panel Detail Rev.
Part Number / Numéro Pièce: 886 SP0406ES	Rev. 1 0

This drawing is confidential and must not be reproduced or used without the consent of EXM

Ce dessin est confidentiel et ne doit pas être reproduit ou utilisé sans le consentement de EXM

No.	Revisions	Date	By/Par

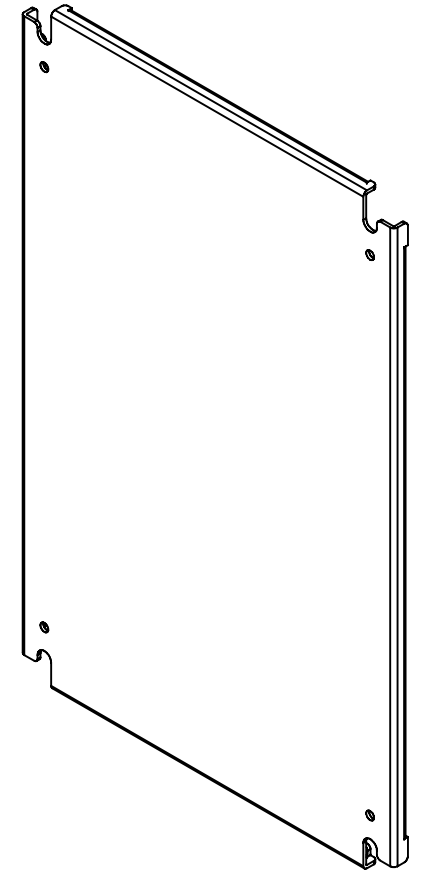

Isometric View



Tél: (450) 979-4373  
 Fax: (450) 979-4626  
 www.exmweb.com

Flatness  
Aplatissement

Max 3.0mm

Projection

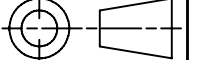

Customer Client	Date
Drawn By Dessiné Par BoxCad	Date 23/Jan/07
Material Matière 12 Ga Galvanized (2.5mm)	
Color Couleur Unpainted	Finish Fini Unpainted
Description 886 SP - Inner Panel	Detail Rev.
Part Number Numéro Pièce <b>886 SP0406ES</b>	Rev. <b>0</b>

Qty	Part Number	Rev	Description
1	886 SP0406ES-P	0	886 SP - Inner Panel Part
Parts List			

2  
2