

This drawing is confidential and must not be reproduced or used without the consent of EXM

Ce dessin est confidentiel et ne doit pas être reproduit ou utilisé sans le consentement de EXM

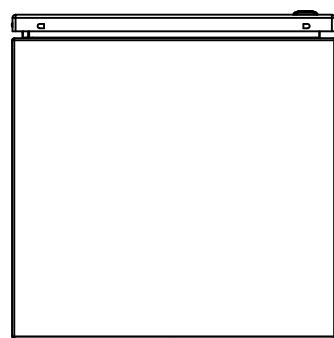

TOP

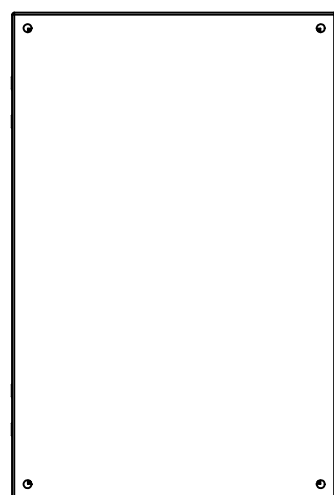

BACK

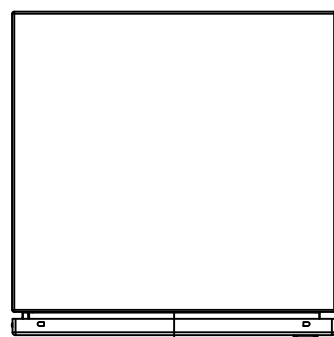

BOTTOM

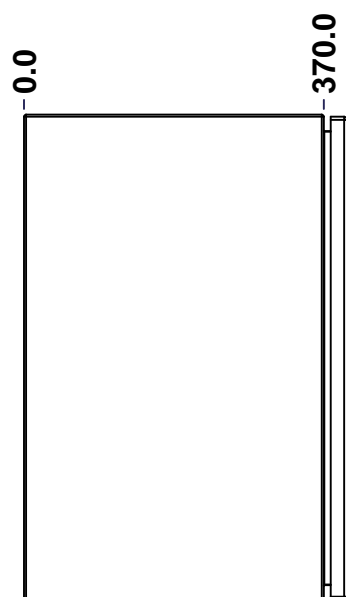

LEFT

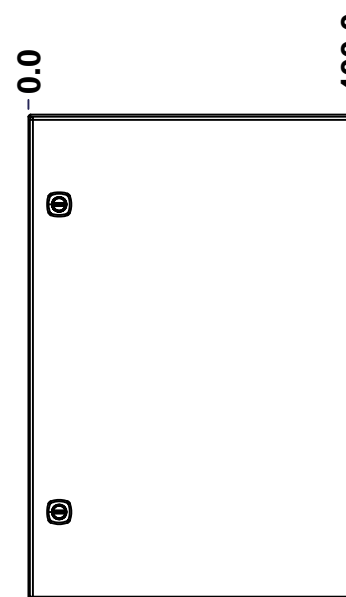

FRONT

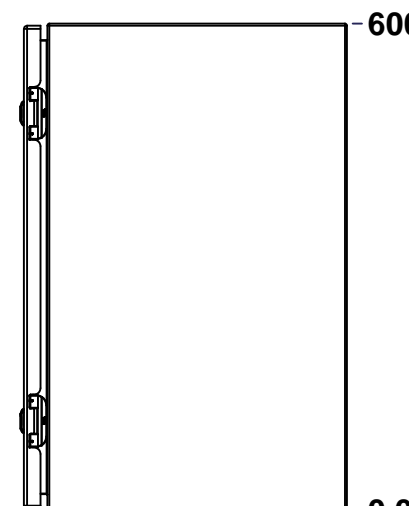

RIGHT

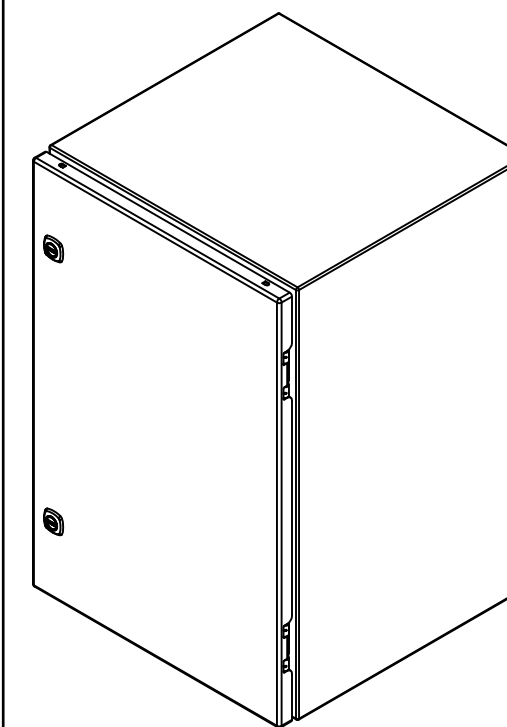

Isometric View



Tél: (450) 979-4373
 Fax: (450) 979-4626
www.exmweb.com

Flatness
 Aplatissement
 Max 3.0mm
 Projection

Customer Client	Date
Drawn By / Dessiné Par: BoxCad: BoxCad	Date: 15-Aug-14
Material / Matière: 14 Ga H.R.P. & O. (1.7mm)	
Color / Couleur: Light Grey RAL7035	Finish / Fini: Rough Textured
Description: 6412ES 600mm x 400mm x 370mm Assembly	Detail Rev.

SEE BILL OF MATERIAL ON LAST PAGE

Part Number / Numéro Pièce: 6412ES040640	Rev. 0	1 / 2
---	---------------	-------

This drawing is confidential and must not be reproduced or used without the consent of EXM

Ce dessin est confidentiel et ne doit pas être reproduit ou utilisé sans le consentement de EXM

NOTE	
ITEM	DESCRIPTION
1	NEMA 4/12 Enclosure
2	C/W Standard ground studs on box and cover
3	C/W Standard door stiffener
4	C/W Standard inner panel (Included)
5	C/W Standard inner panel mounting studs

No.	Revisions	Date	By/Par

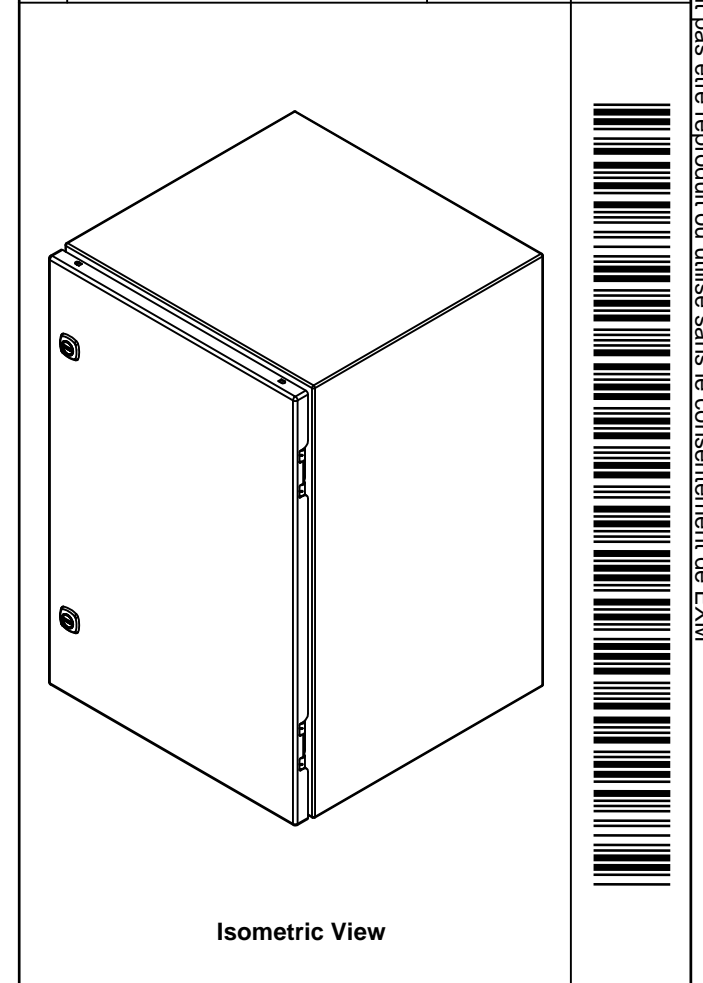

PACKING		
ITEM	QTY	DESCRIPTION
Cardboard sleeve	2	Top and Bottom
Cardboard strip	2	Between back of enclosure and inner panel
Plastic bag	1	To protect cover surface and inside gasket
Plastic strap - Black	2	To Squeeze the 2 cardboard sleeve together
Packaging label	1	White label with product number

1	STK-K-01800	5	5412 ES Accessory Kit
1	886 SP0406ES	0	886 SP - Inner Panel
1	6412ES040640C	0	6412ES 600mm x 400mm Cover
4	STK-Q-07310	2	Flange Lock Nut M8
4	STK-Q-07610	8	M8 Plastic Spacer 22.2mm
1	6412ES040640B	0	6412ES 600mm x 400mm x 370mm Body
2	STK-Q-04050-07	7	M6 x 7mm Hexagon Socket Head Machine Screw with Nyseal
Qty	Part Number	Rev	Description
Parts List			

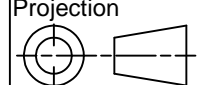
 Tél: (450) 979-4373 Fax: (450) 979-4626 www.exmweb.com		Flatness Aplatissement Max 3.0mm Projection 
Customer Client	Date	
Drawn By Dessiné Par	BoxCad: BoxCad	Date 15-Aug-14
Material Matière	14 Ga H.R.P. & O. (1.7mm)	
Color Couleur	Light Grey RAL7035	Finish Fini
		Rough Textured
Description 6412ES 600mm x 400mm x 370mm Assembly		Detail Rev.
Part Number Numéro Pièce		Rev.
6412ES040640		0
		2

This drawing is confidential and must not be reproduced or used without the consent of EXM

Ce dessin est confidentiel et ne doit pas être reproduit ou utilisé sans le consentement de EXM

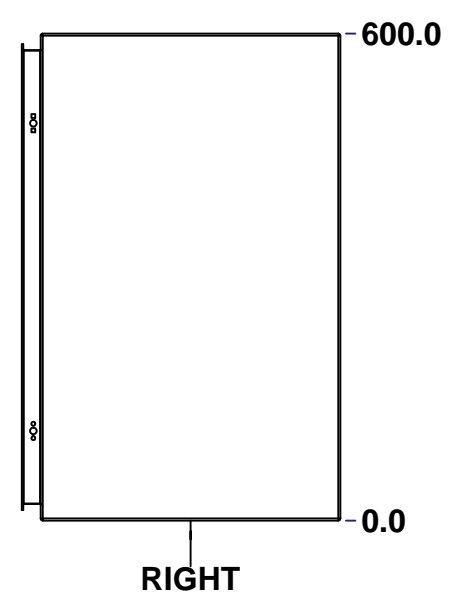
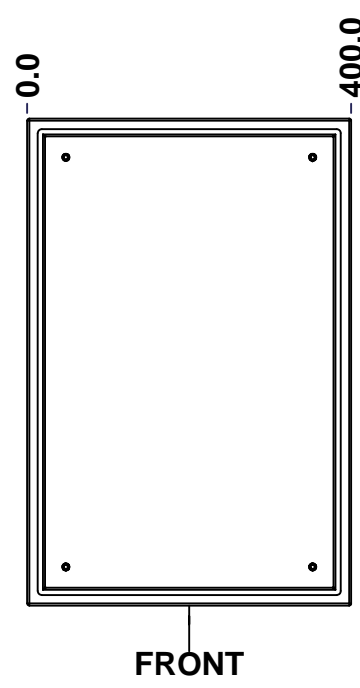
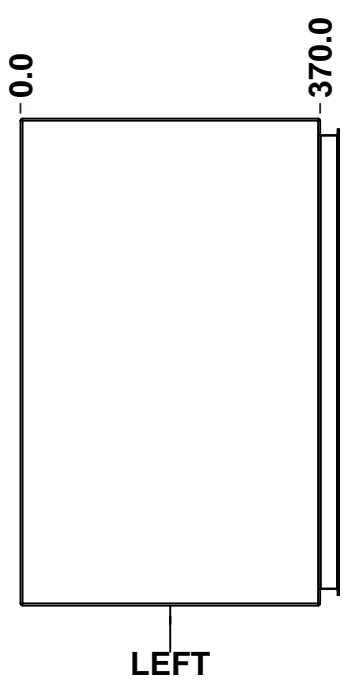
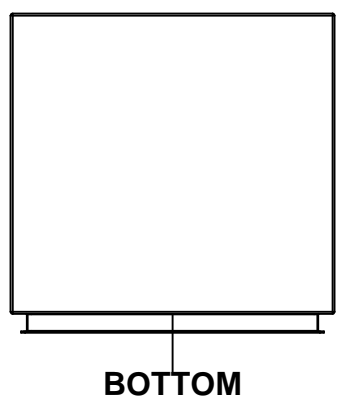
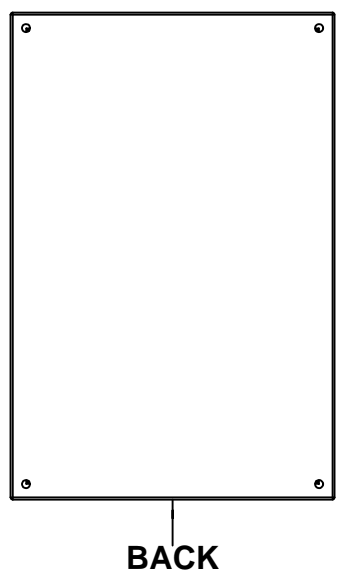
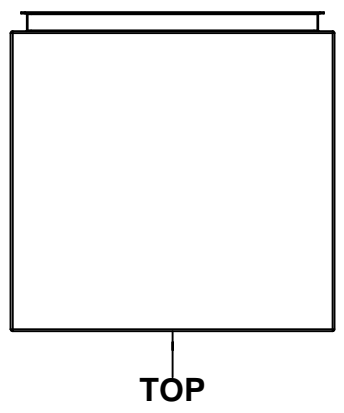

No.	Revisions	Date	By/Par

Isometric View

Tél: (450) 979-4373 Fax: (450) 979-4626 www.exmweb.com		Flatness Aplatissement	
		Max 3.0mm	
Customer Client		Date	
Drawn By Dessiné Par BoxCad: BoxCad		Date 15-Aug-14	
Material Matière 14 Ga H.R.P. & O. (1.7mm)			
Color Couleur Light Grey RAL7035		Finish Fini Rough Textured	
Description 6412ES 600mm x 400mm x 370mm Body			Detail Rev.
Part Number Numéro Pièce 6412ES040640B		Rev. 0	1 / 7

SEE BILL OF MATERIAL ON LAST PAGE

This drawing is confidential and must not be reproduced or used without the consent of EXM

Ce dessin est confidentiel et ne doit pas être reproduit ou utilisé sans le consentement de EXM

STANDARD FEATURES ARE NOT LISTED IN THIS HOLE TABLE			
HOLE TABLE - RIGHT VIEW (CUSTOM FEATURE ONLY)			
CUT-OUT	XDIM	YDIM	DESCRIPTION
1	331.9	50.8	GND STUD M6 x 16mm (Inside)

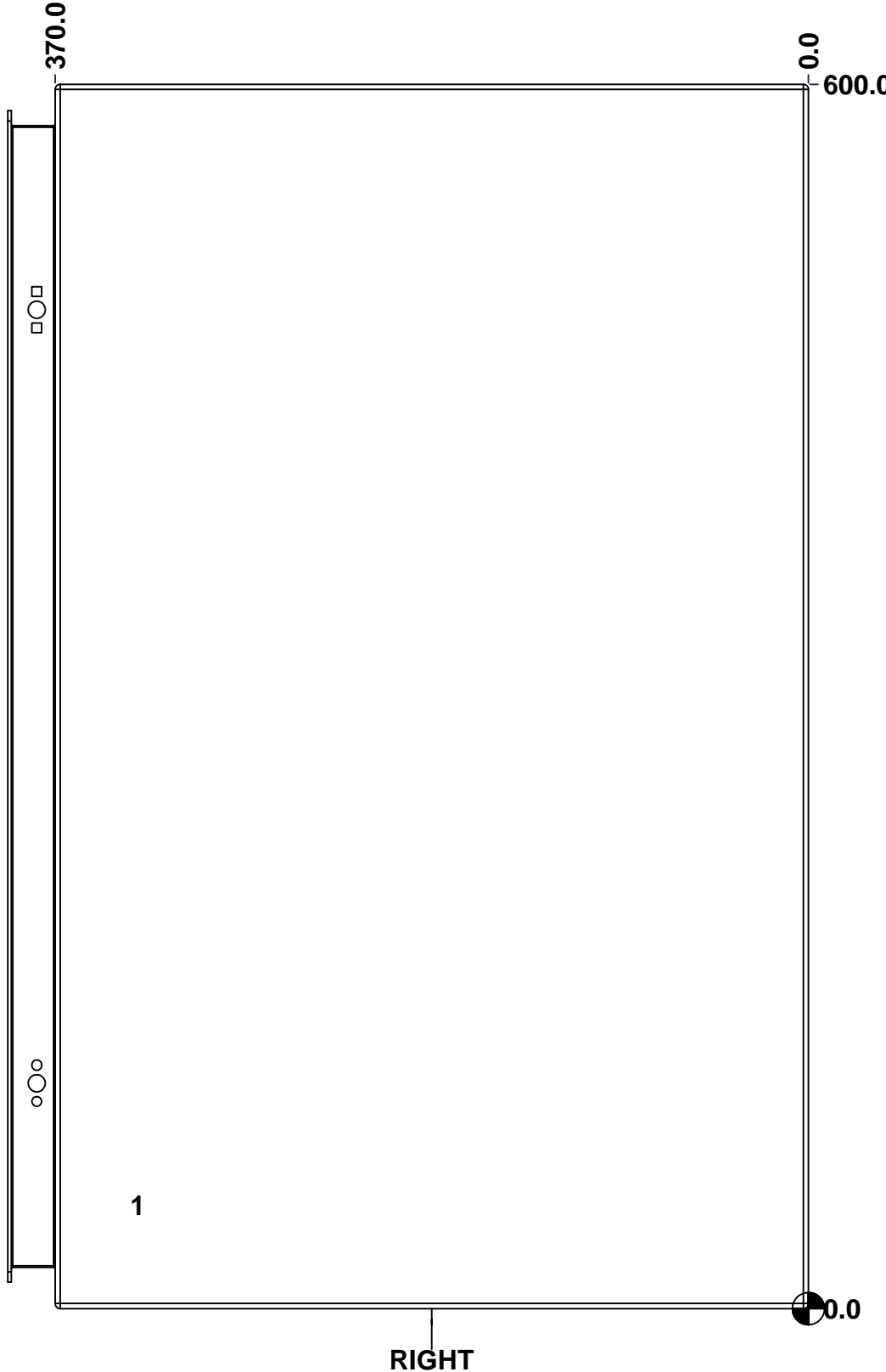

	Description 6412ES 600mm x 400mm x 370mm Body	Status
	Part Number Numéro Pièce 6412ES040640B	Rev. 3 0 / 7

This drawing is confidential and must not be reproduced or used without the consent of EXM

Ce dessin est confidentiel et ne doit pas être reproduit ou utilisé sans le consentement de EXM

STANDARD FEATURES ARE NOT LISTED IN THIS HOLE TABLE

HOLE TABLE - BACK VIEW (CUSTOM FEATURE ONLY)

CUT-OUT	XDIM	YDIM	DESCRIPTION
1	47.6	47.6	IP STUD M8 x 35mm (Inside)
2	47.6	552.4	IP STUD M8 x 35mm (Inside)
3	352.4	552.4	IP STUD M8 x 35mm (Inside)
4	352.4	47.6	IP STUD M8 x 35mm (Inside)

5	381.0	19.1	RND Ø9.9
6	381.0	581.0	RND Ø9.9
7	19.1	581.0	RND Ø9.9
8	19.1	19.1	RND Ø9.9

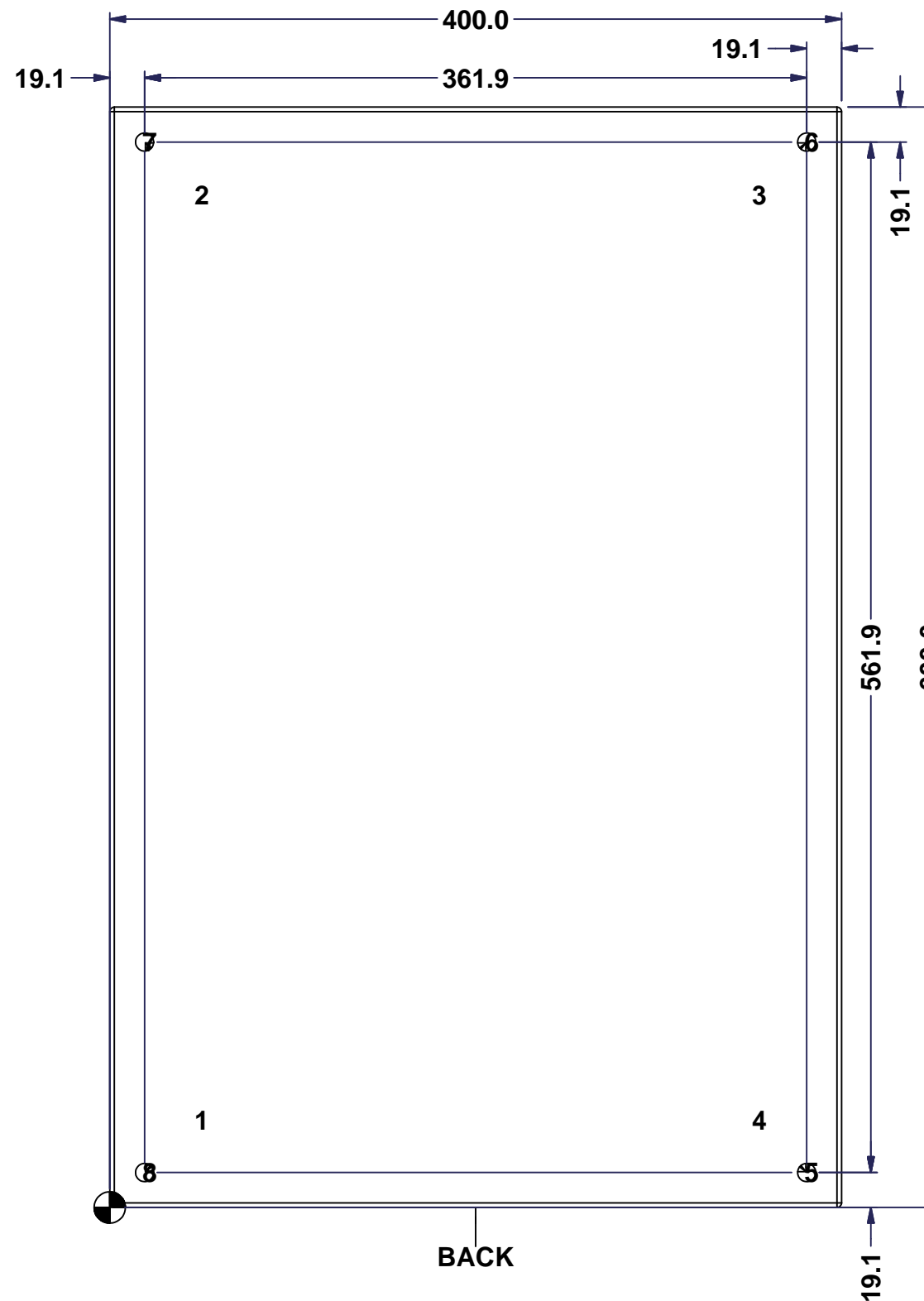

BACK

	Description		Status	
	6412ES 600mm x 400mm x 370mm Body			
	Part Number		Rev.	6
	Numéro Pièce		0	7
		6412ES040640B		

This drawing is confidential and must not be reproduced or used without the consent of EXM

Ce dessin est confidentiel et ne doit pas être reproduit ou utilisé sans le consentement de EXM

No.	Revisions	Date	By/Par

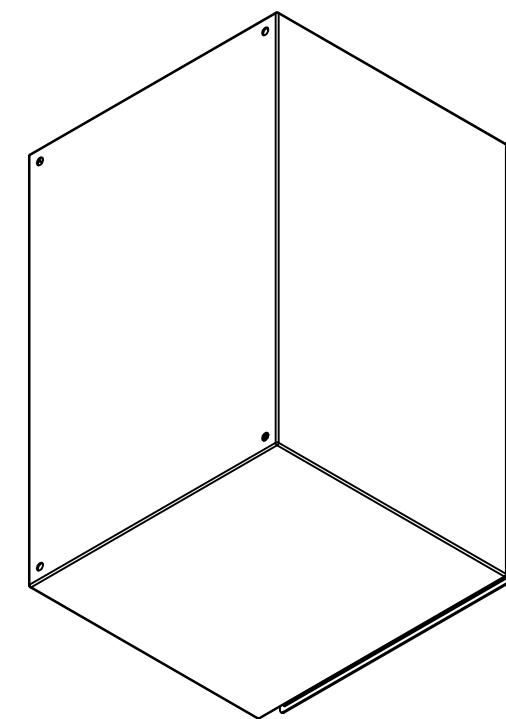

Isometric View

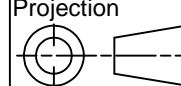

 Tél: (450) 979-4373 Fax: (450) 979-4626 www.exmweb.com		Flatness Aplatissement Max 3.0mm Projection 
Customer Client	Date	
Drawn By Dessiné Par	BoxCad: BoxCad	Date 15-Aug-14
Material Matière	14 Ga H.R.P. & O. (1.7mm)	
Color Couleur	Light Grey RAL7035	Finish Fini
Description		Detail Rev.
6412ES 600mm x 400mm x 370mm Body		
Part Number Numéro Pièce	Rev.	7
6412ES040640B	0	7

Qty	Part Number	Rev	Description
1	STK-Q-16080	0	Ground Stud M6 x 16mm
1	STK-P-03820R	0	Powder Paint (Light Grey / Rough Textured)
4	STK-Q-16005	1	Stud M8 x 35 (No Paint Cap Required)
1	6412ES040640B-P	0	6412ES 600mm x 400mm x 370mm Body Part
Parts List			

This drawing is confidential and must not be reproduced or used without the consent of EXM

Ce dessin est confidentiel et ne doit pas être reproduit ou utilisé sans le consentement de EXM

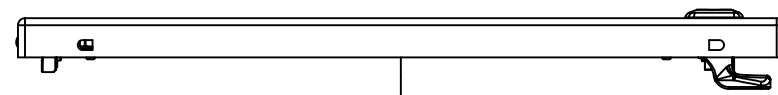

TOP

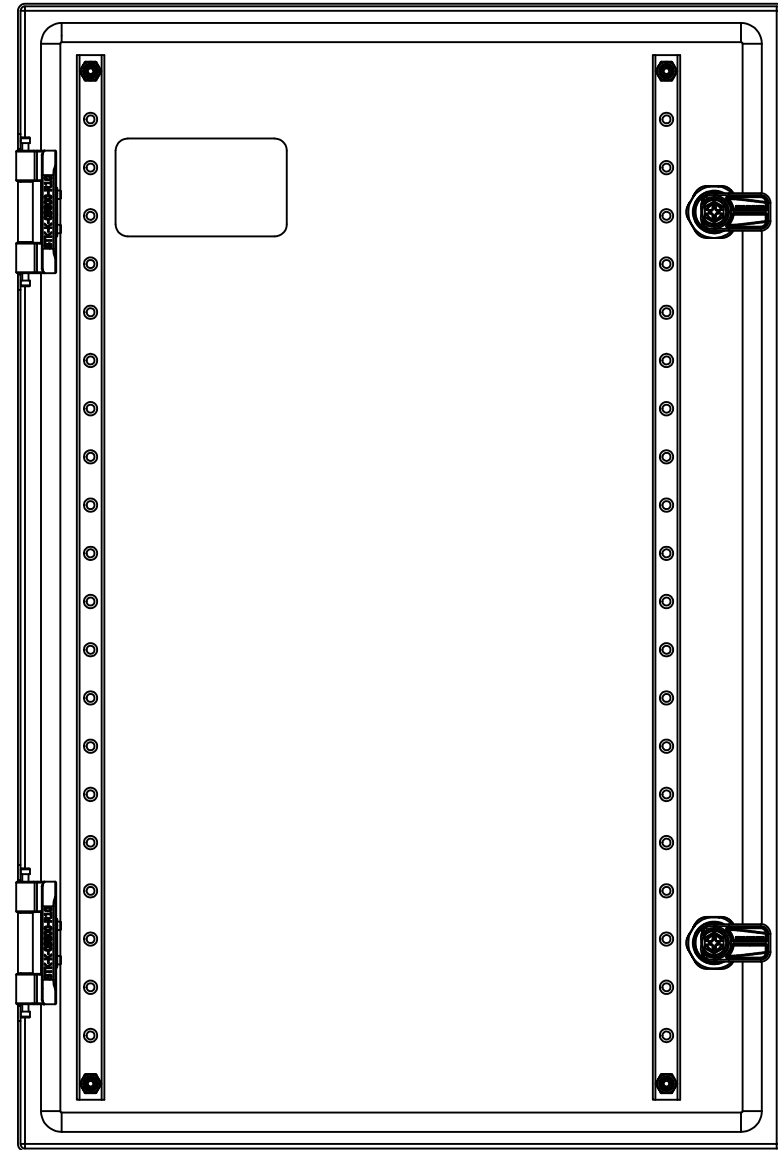

BACK

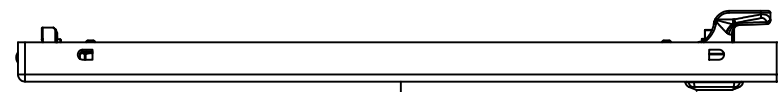

BOTTOM

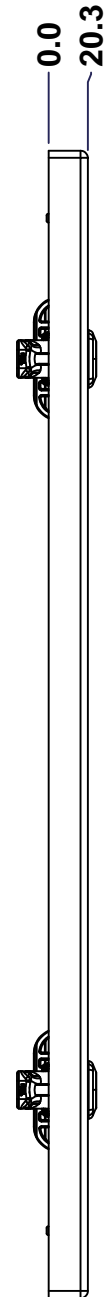

LEFT

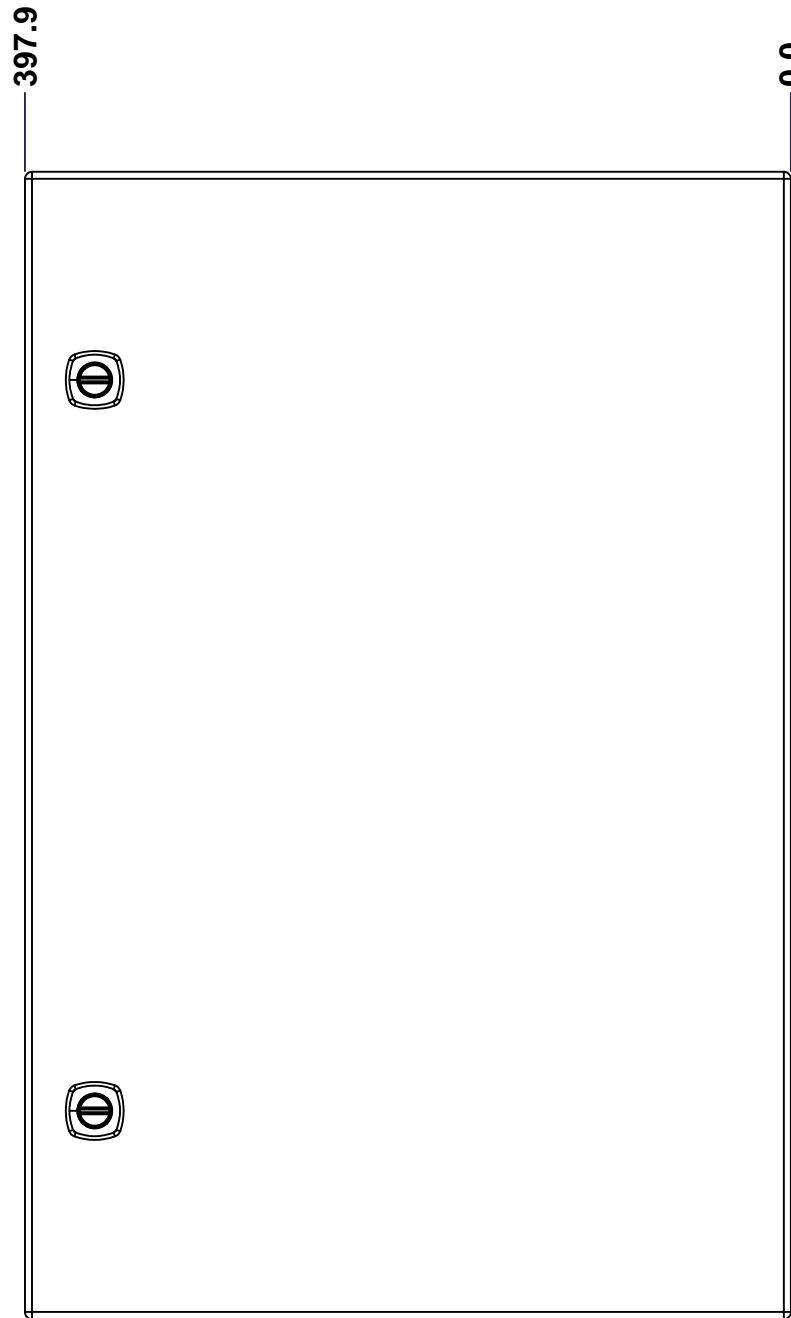

FRONT

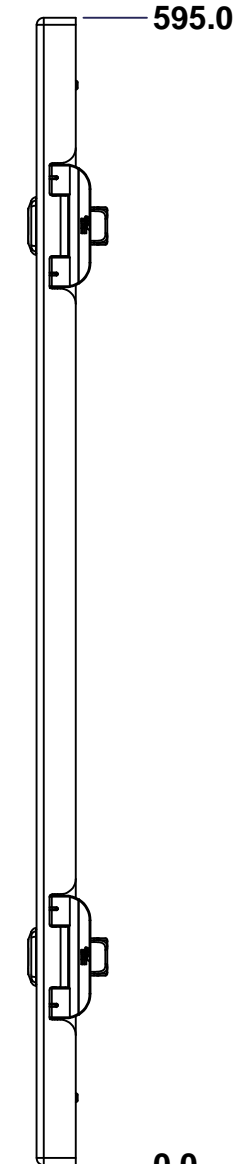

RIGHT

No.	Revisions	Date	By/Par

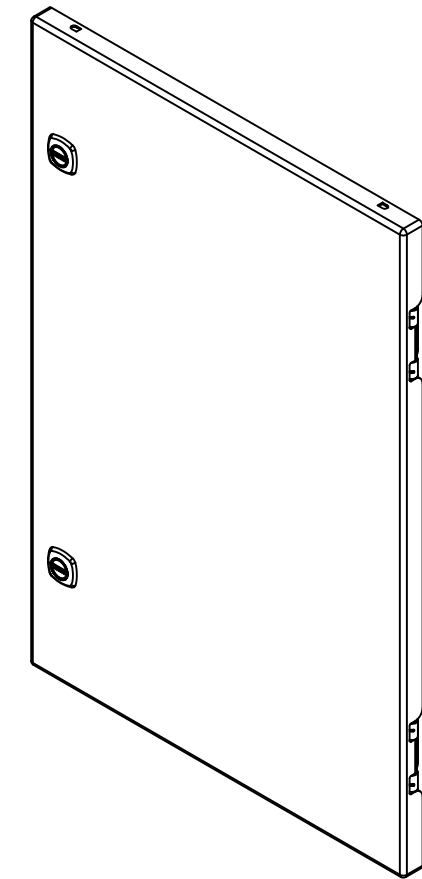

Isometric View

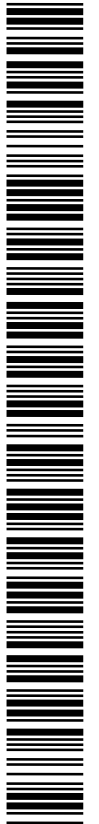

Tél: (450) 979-4373
 Fax: (450) 979-4626
www.exmweb.com

Flatness
Aplatissement

Max 3.0mm

Projection

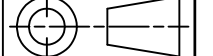

Customer Client	Date
Drawn By / Dessiné Par: BoxCad: BoxCad	Date: 15-Aug-14

Material / Matière: 16 Ga H.R.P. & O. (1.4mm)

Color / Couleur: Light Grey RAL7035	Finish / Fini: Rough / Textured
-------------------------------------	---------------------------------

Description: 6412ES 600mm x 400mm Cover	Detail Rev.
---	-------------

Part Number / Numéro Pièce: 6412ES040640C	Rev. 0	1 / 3
---	--------	-------

SEE BILL OF MATERIAL ON LAST PAGE

This drawing is confidential and must not be reproduced or used without the consent of EXM

Ce dessin est confidentiel et ne doit pas être reproduit ou utilisé sans le consentement de EXM

STANDARD FEATURES ARE NOT LISTED IN THIS HOLE TABLE

HOLE TABLE - FRONT VIEW (CUSTOM FEATURE ONLY)

CUT-OUT	XDIM	YDIM	DESCRIPTION
1	37.7	35.0	STUD M6 x 18mm (Inside)
2	37.7	560.0	STUD M6 x 18mm (Inside)
3	336.9	560.0	STUD M6 x 18mm (Inside)
4	336.9	35.0	STUD M6 x 18mm (Inside)

5	95.3	499.7	LABEL_EXM (Inside)
6	361.7	487.0	LOCK 880 SCQ4-SL @ 180.0°
7	361.7	108.0	LOCK 880 SCQ4-SL @ 180.0°

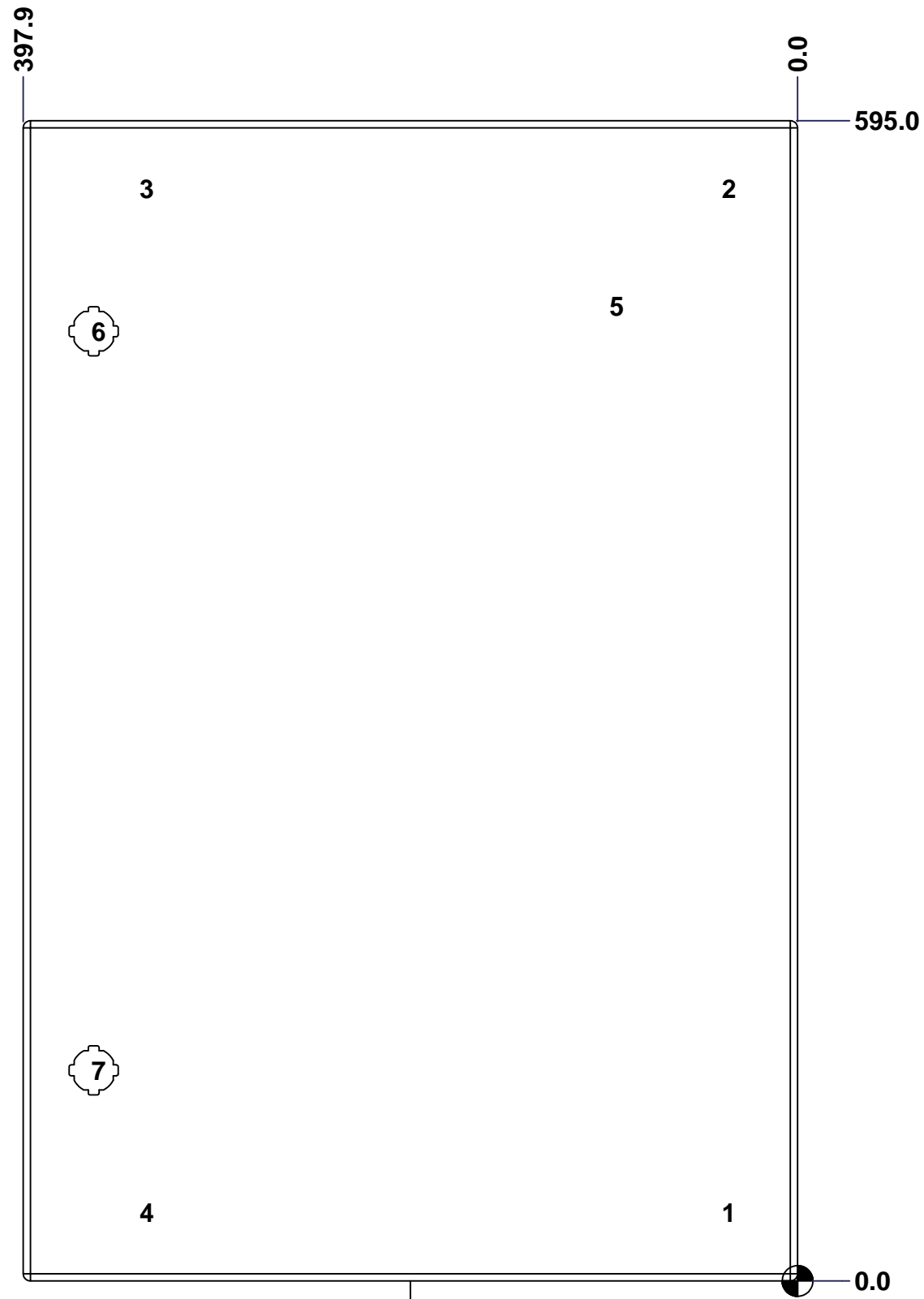

FRONT

	Description	Status
	6412ES 600mm x 400mm Cover	(NULL)
	Part Number Numéro Pièce	Rev.
	6412ES040640C	0
		2
		3

This drawing is confidential and must not be reproduced or used without the consent of EXM

Ce dessin est confidentiel et ne doit pas être reproduit ou utilisé sans le consentement de EXM

No.	Revisions	Date	By/Par

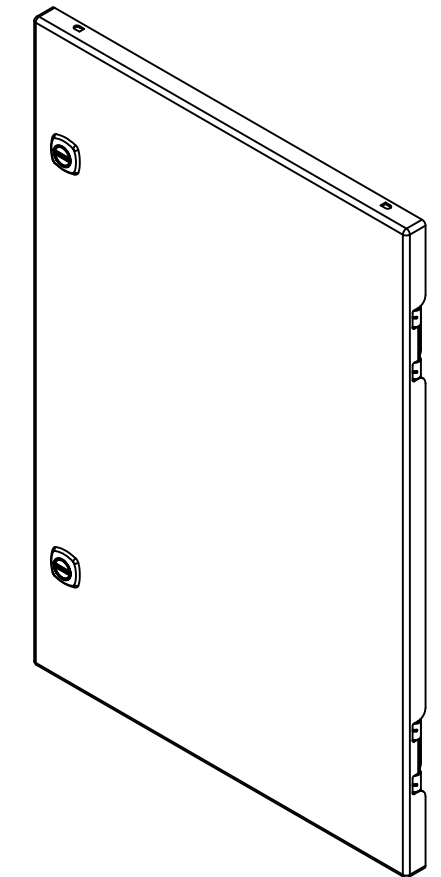

Isometric View



 Tél: (450) 979-4373
 Fax: (450) 979-4626
www.exmweb.com

Flatness Aplatissement
 Max 3.0mm
 Projection 

Customer Client _____ Date _____
 Drawn By Dessiné Par BoxCad: BoxCad Date 15-Aug-14

Material Matière 16 Ga H.R.P. & O. (1.4mm)

Color Couleur Light Grey RAL7035 Finish Fini Rough Textured

Description 6412ES 600mm x 400mm Cover
 Detail Rev. _____

Part Number Numéro Pièce **6412ES040640C**
 Rev. 0 3

Qty	Part Name	Rev	Description
1	STK-S-00100	0	3.5" x 2" Silver Milar Flexcon Sticker
1	STK-P-03820R	0	Powder Paint (Light Grey / Rough Textured)
2	STK-Q-46020-24	5	5412 ES Vertical Door Stiffener 24"
4	STK-Q-16055	1	M6 x 18mm Stud (No Paint Cap Required)
1	6412ES040640G	0	6412ES 600mm x 400mm Cover Gasket Part
1	6412ES040640C-P	0	6412ES 600mm x 400mm Cover Part
2	STK-K-09800		5412 ES Hinge with 2 Captive Hinge Pins
2	880 SCQ4-SL	6	5412 ES 1/4 Turn Lock
4	STK-Q-07220	1	M6 Nylon Insert Lock Nut
Parts List			

This drawing is confidential and must not be reproduced or used without the consent of EXM

Ce dessin est confidentiel et ne doit pas être reproduit ou utilisé sans le consentement de EXM

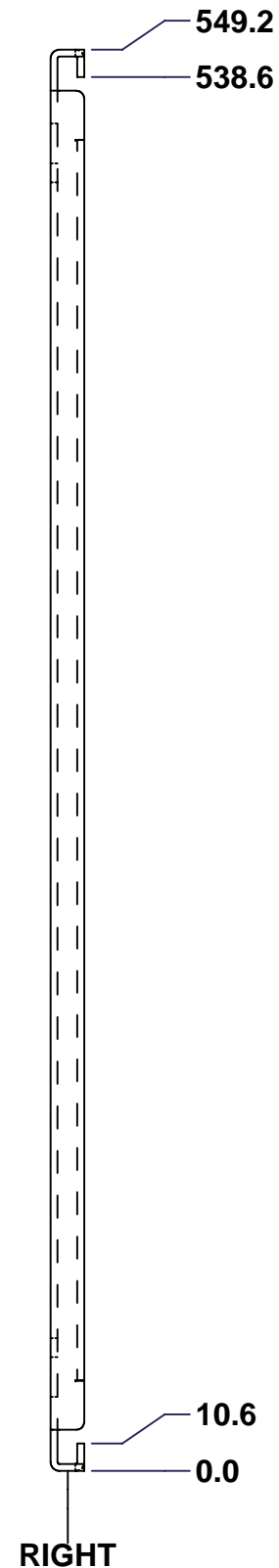
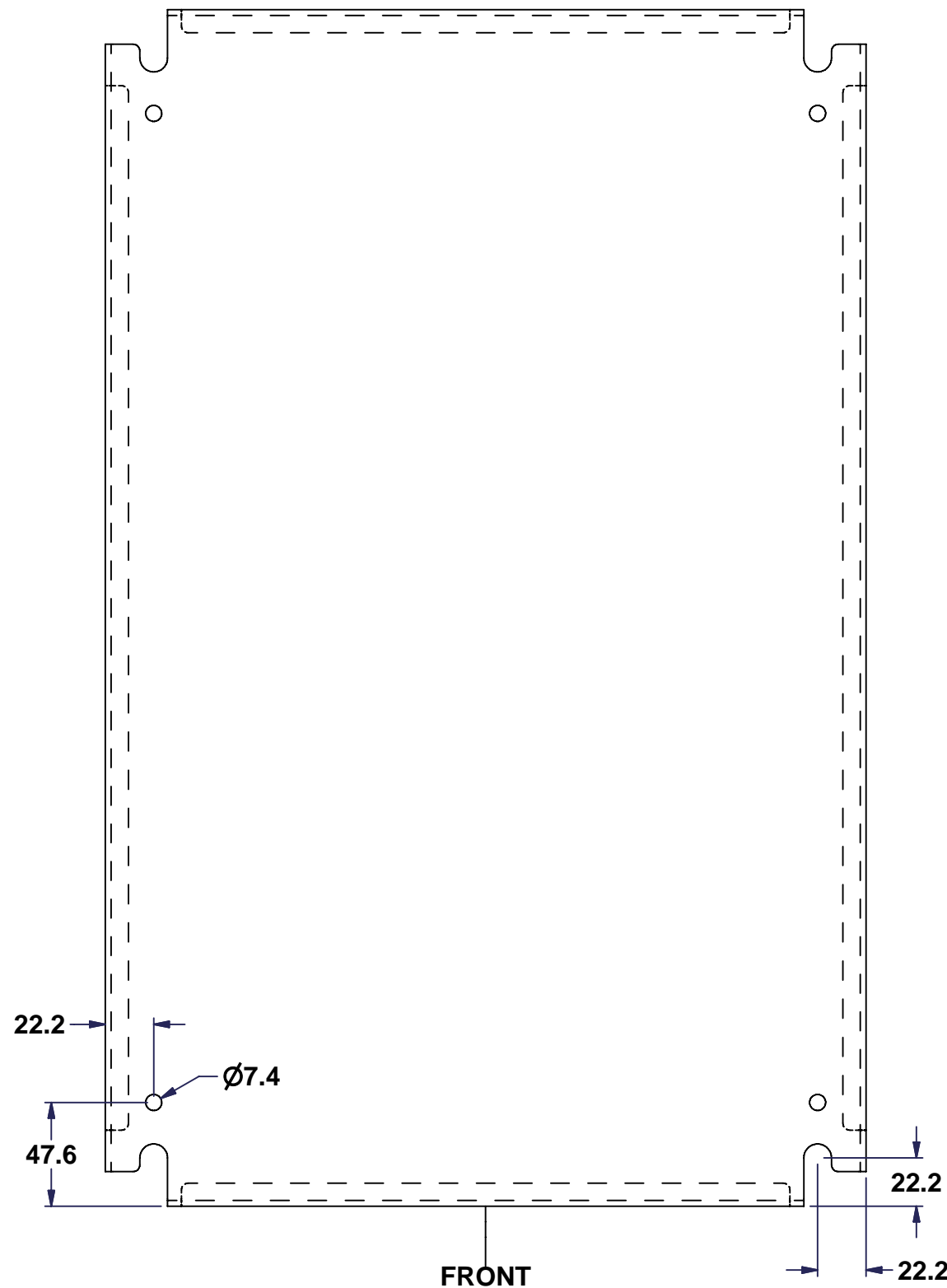
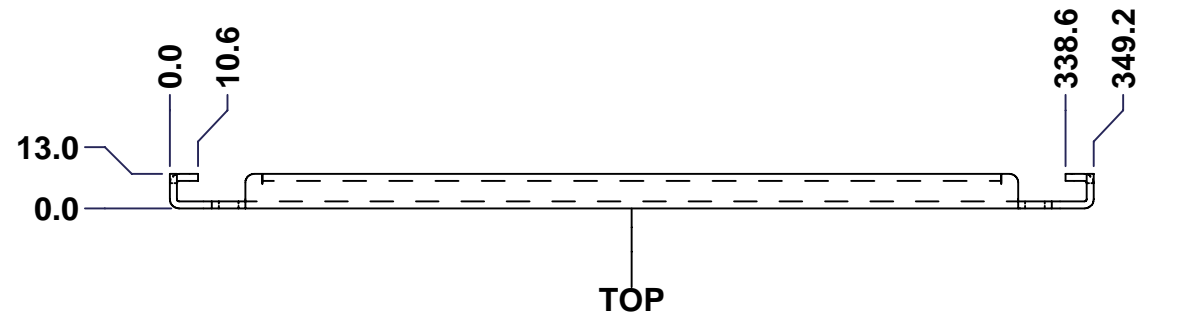

SEE BILL OF MATERIAL ON LAST PAGE

No.	Revisions	Date	By/Par

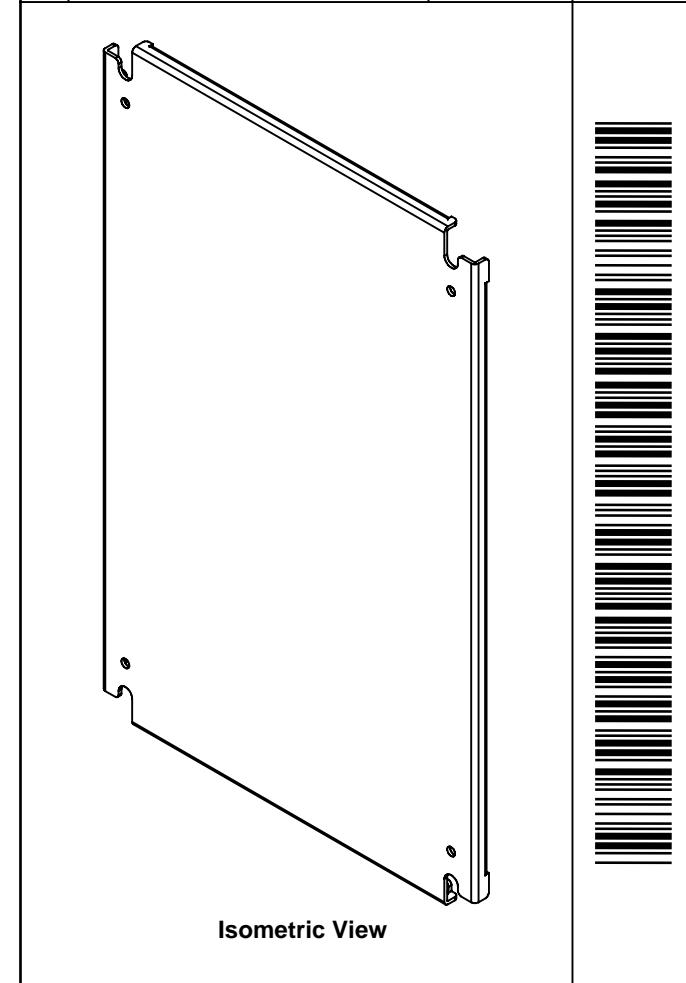

Tél: (450) 979-4373 Fax: (450) 979-4626 www.exmweb.com		Flatness Aplatissement Max 3.0mm
Projection 		Customer Client
Drawn By Dessiné Par: BoxCad		Date: 23/Jan/07
Material Matière: 12 Ga Galvanized (2.5mm)		
Color Couleur: Unpainted	Finish Fini: Unpainted	
Description: 886 SP - Inner Panel		Detail Rev.
Part Number Numéro Pièce: 886 SP0406ES		Rev. 1 0

This drawing is confidential and must not be reproduced or used without the consent of EXM

Ce dessin est confidentiel et ne doit pas être reproduit ou utilisé sans le consentement de EXM

No.	Revisions	Date	By/Par

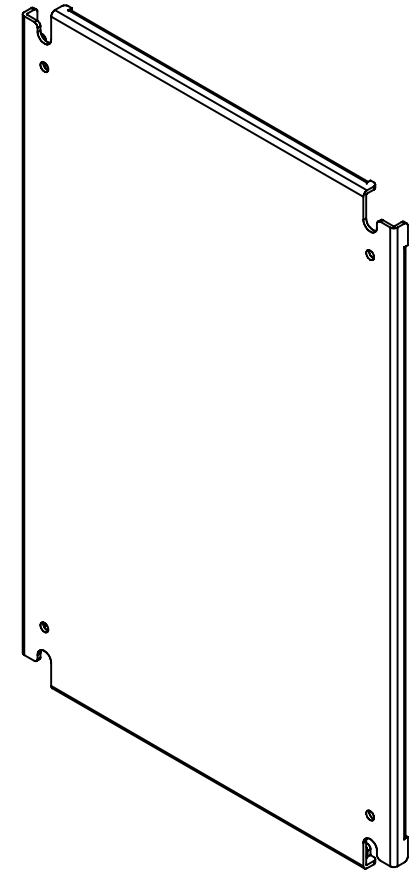

Isometric View

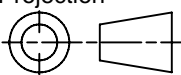

 Tél: (450) 979-4373 Fax: (450) 979-4626 www.exmweb.com		Flatness Aplatissement Max 3.0mm
Customer Client		Projection 
Drawn By Dessiné Par BoxCad		Date 23/Jan/07
Material Matière 12 Ga Galvanized (2.5mm)		
Color Couleur Unpainted	Finish Fini Unpainted	
Description 886 SP - Inner Panel		Detail Rev.
Part Number Numéro Pièce 886 SP0406ES	Rev. 0	2 2

Qty	Part Number	Rev	Description
1	886 SP0406ES-P	0	886 SP - Inner Panel Part
Parts List			