

This drawing is confidential and must not be reproduced or used without the consent of EXM

Ce dessin est confidentiel et ne doit pas être reproduit ou utilisé sans le consentement de EXM

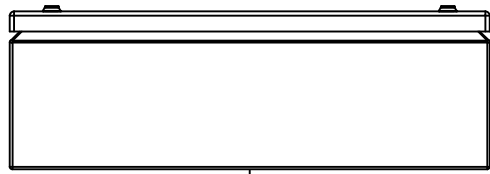

TOP

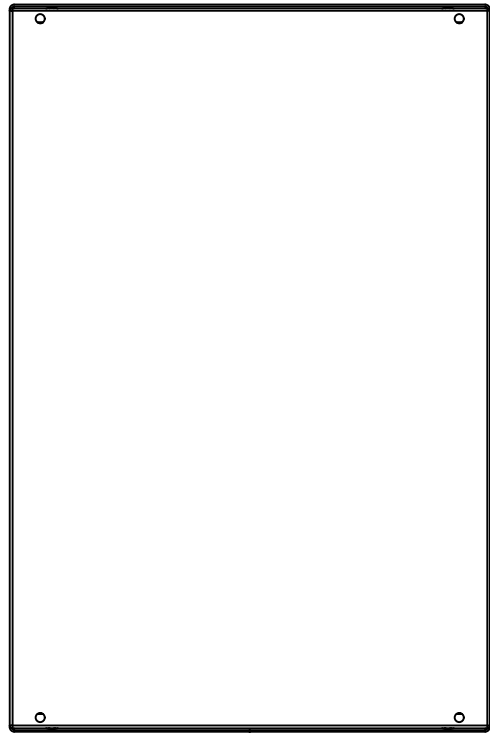

BACK

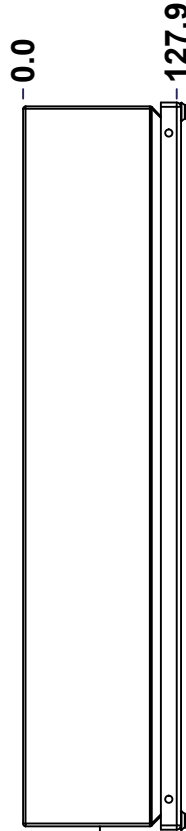

LEFT

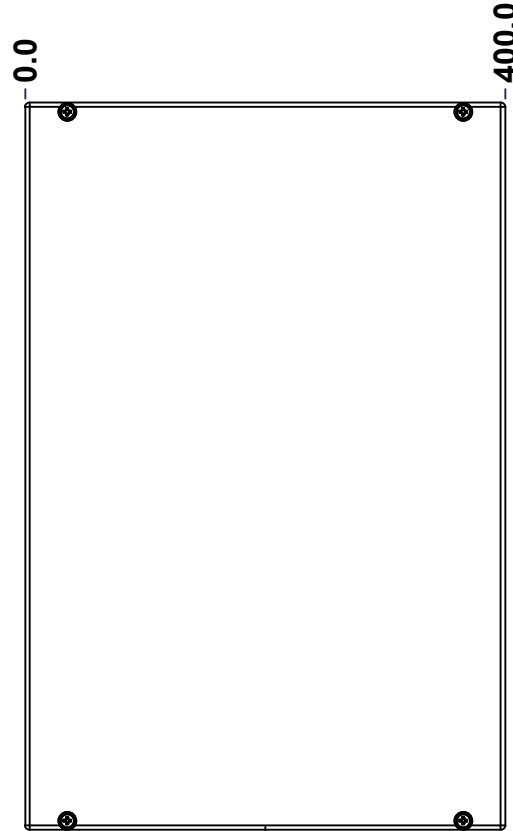

FRONT

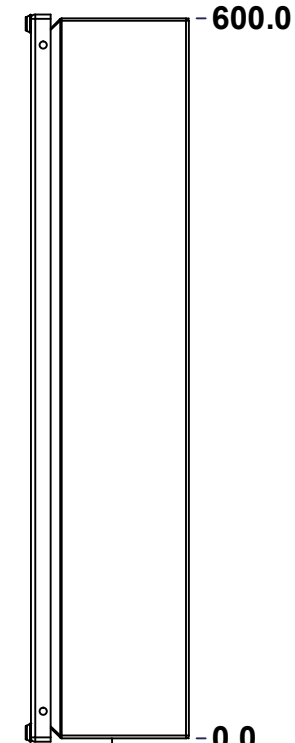

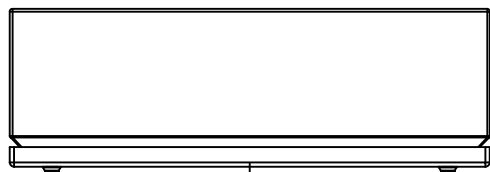

RIGHT

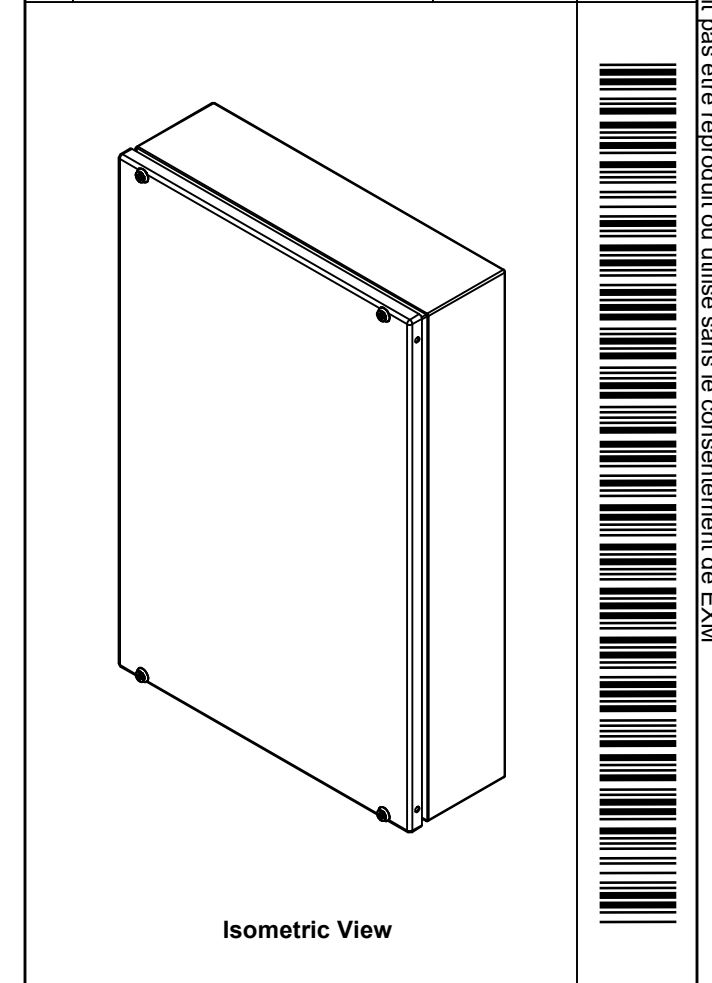

BOTTOM

No.	Revisions	Date	By/Par

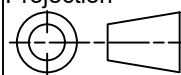

 Tél: (450) 979-4373 Fax: (450) 979-4626 www.exmweb.com		Flatness Aplatissement Max 3.0mm Projection 
Customer Client	Date	
Drawn By Dessiné Par	BoxCad: BoxCad	Date 18-Apr-16
Material Matière	16 Ga Cold Rolled A1008 CS Type B (1.4mm)	
Color Couleur	Light Grey RAL7035	Finish Fini Textured
Description 6412ESTB 600mm x 400mm x 127.9mm Assembly		Detail Rev.
Part Number Numéro Pièce	6412ESTB604012	Rev. 1 0

SEE BILL OF MATERIAL ON LAST PAGE

This drawing is confidential and must not be reproduced or used without the consent of EXM

Ce dessin est confidentiel et ne doit pas être reproduit ou utilisé sans le consentement de EXM

NOTE	
ITEM	DESCRIPTION
1	NEMA 4, 12 Enclosure (IP66)
2	C/W Standard ground standoffs on box and cover
3	W/O Standard door stiffener
4	W/O Inner panel
5	C/W Standard inner panel mounting standoffs

No.	Revisions	Date	By/Par

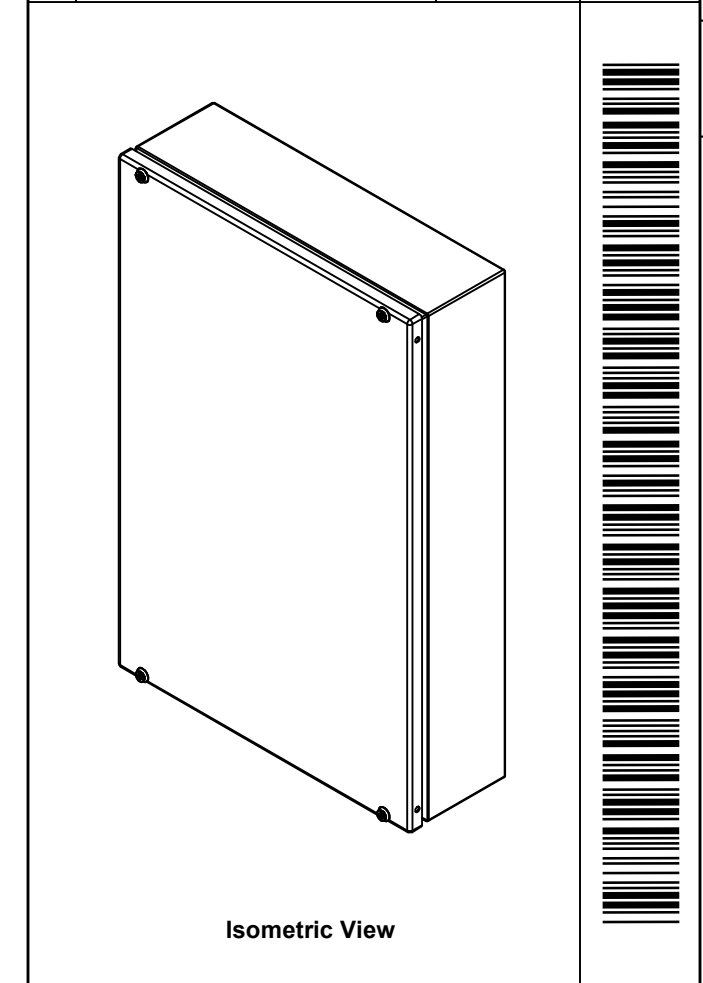

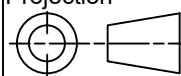
 Tél: (450) 979-4373 Fax: (450) 979-4626 www.exmweb.com	Flatness Aplatissement Max 3.0mm
	Projection 
Customer Client	Date
Drawn By Dessiné Par BoxCad: BoxCad	Date 18-Apr-16
Material Matière 16 Ga Cold Rolled A1008 CS Type B (1.4mm)	
Color Couleur Light Grey RAL7035	Finish Fini Textured
Description 6412ESTB 600mm x 400mm x 127.9mm Assembly	
Part Number Numéro Pièce 6412ESTB604012	Detail Rev. Rev. 2 0 / 9

PACKING		
ITEM	QTY	DESCRIPTION
Cardboard sleeve	2	Top and Bottom
Cardboard strip	2	Between back of enclosure and inner panel
Plastic bag	1	To protect cover surface and inside gasket
Packaging label	1	White label with product number

Qty	Part Number	Rev	Description
1	6412ESTB604012C	0	6412ESTB 600mm x 400mm Cover
2	6412ESTB604012BR-P	0	6412ESTB 600mm Bracket Part
1	STK-K-02920	3	5412 ESSC Accessory Kit
1	6412ESTB604012B	0	6412ESTB 600mm x 400mm x 127.9mm Body
Parts List			

This drawing is confidential and must not be reproduced or used without the consent of EXM

Ce dessin est confidentiel et ne doit pas être reproduit ou utilisé sans le consentement de EXM

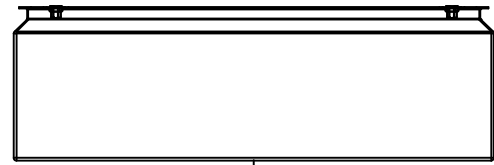

TOP

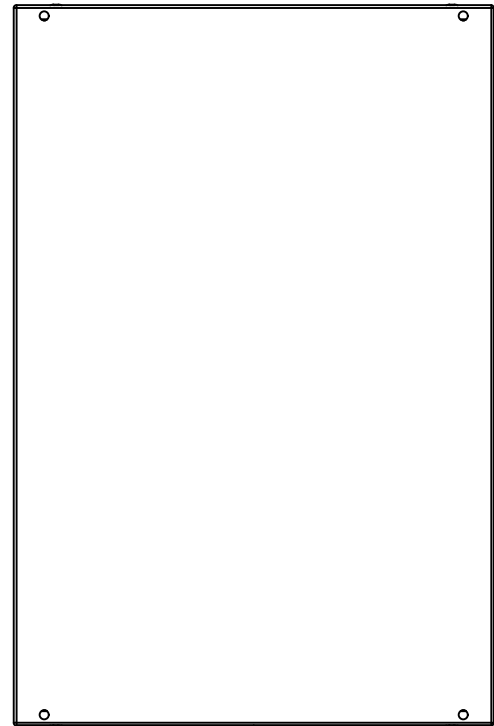

BACK

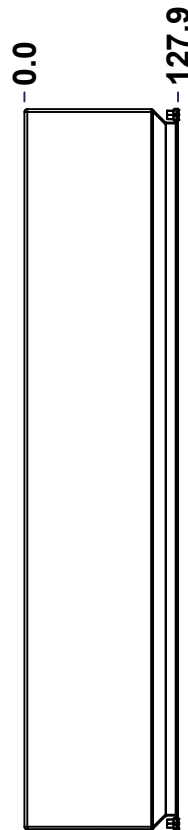

LEFT

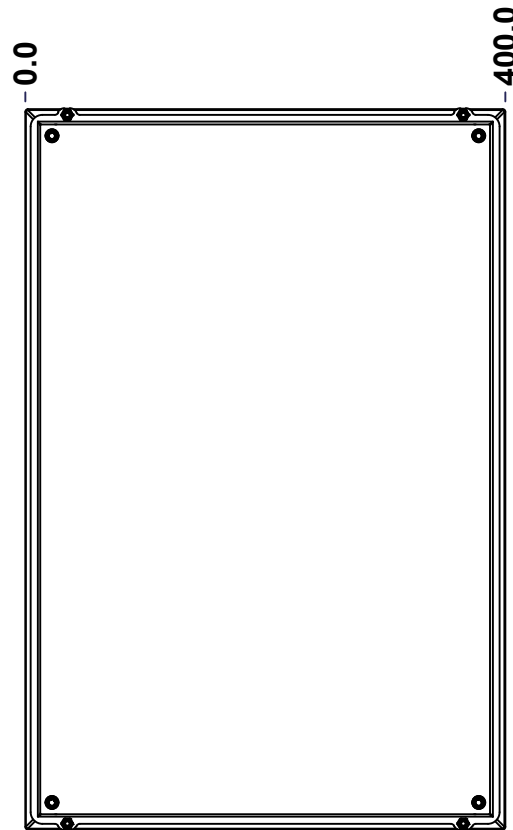

FRONT

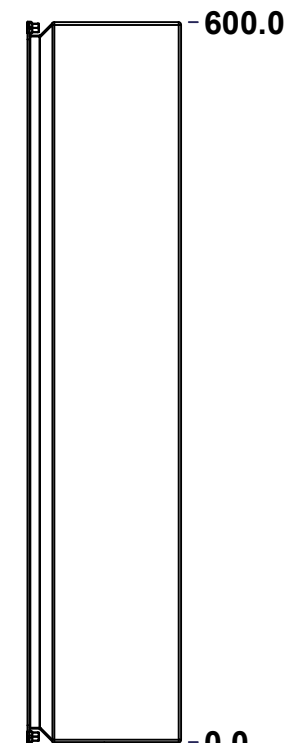

RIGHT

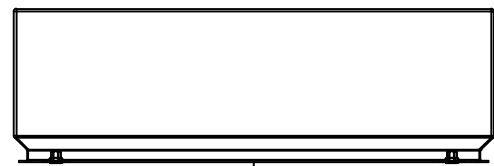

BOTTOM

No.	Revisions	Date	By/Par

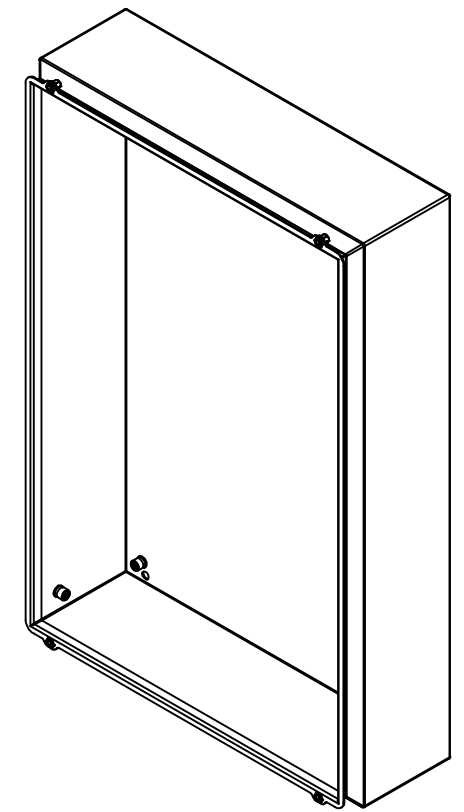

Isometric View



Tél: (450) 979-4373
 Fax: (450) 979-4626
www.exmweb.com

Flatness
Aplatissement

Max 3.0mm

Projection

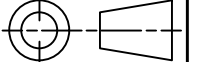

Customer Client	Date
Drawn By / Dessiné Par: BoxCad: BoxCad	Date: 18-Apr-16
Material / Matière: 16 Ga Cold Rolled A1008 CS Type B (1.4mm)	

Color / Couleur: Light Grey RAL7035	Finish / Fini: Textured
-------------------------------------	-------------------------

Description: 6412ESTB 600mm x 400mm x 127.9mm Body	Detail Rev.
--	-------------

Part Number / Numéro Pièce: 6412ESTB604012B	Rev. 0	3	9
---	--------	---	---

SEE BILL OF MATERIAL ON LAST PAGE

This drawing is confidential and must not be reproduced or used without the consent of EXM

Ce dessin est confidentiel et ne doit pas être reproduit ou utilisé sans le consentement de EXM

STANDARD FEATURES ARE NOT LISTED IN THIS HOLE TABLE			
HOLE TABLE - LEFT VIEW (CUSTOM FEATURE ONLY)			
CUT-OUT	XDIM	YDIM	DESCRIPTION
1	85.1	22.2	STANDOFF M6 x 10mm (Inside)
2	85.1	22.2	STANDOFF M6 x 10mm (Inside)

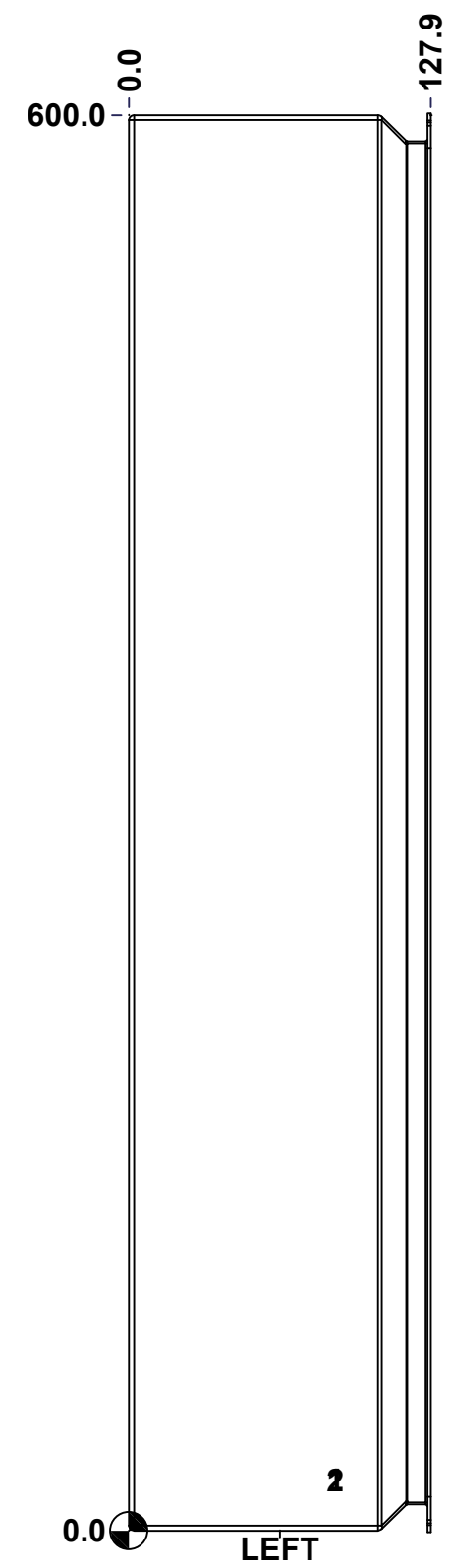

	Description 6412ESTB 600mm x 400mm x 120mm Body	Status (NULL)
	Part Number Numéro Pièce 6412ESTB604012B	Rev. 4 0 / 9

This drawing is confidential and must not be reproduced or used without the consent of EXM

Ce dessin est confidentiel et ne doit pas être reproduit ou utilisé sans le consentement de EXM

STANDARD FEATURES ARE NOT LISTED IN THIS HOLE TABLE

HOLE TABLE - BACK VIEW (CUSTOM FEATURE ONLY)

CUT-OUT	XDIM	YDIM	DESCRIPTION
1	22.2	22.2	IP STANDOFF M6 x 10mm (Inside)
2	22.2	577.8	IP STANDOFF M6 x 10mm (Inside)
3	377.8	577.8	IP STANDOFF M6 x 10mm (Inside)
4	377.8	22.2	IP STANDOFF M6 x 10mm (Inside)

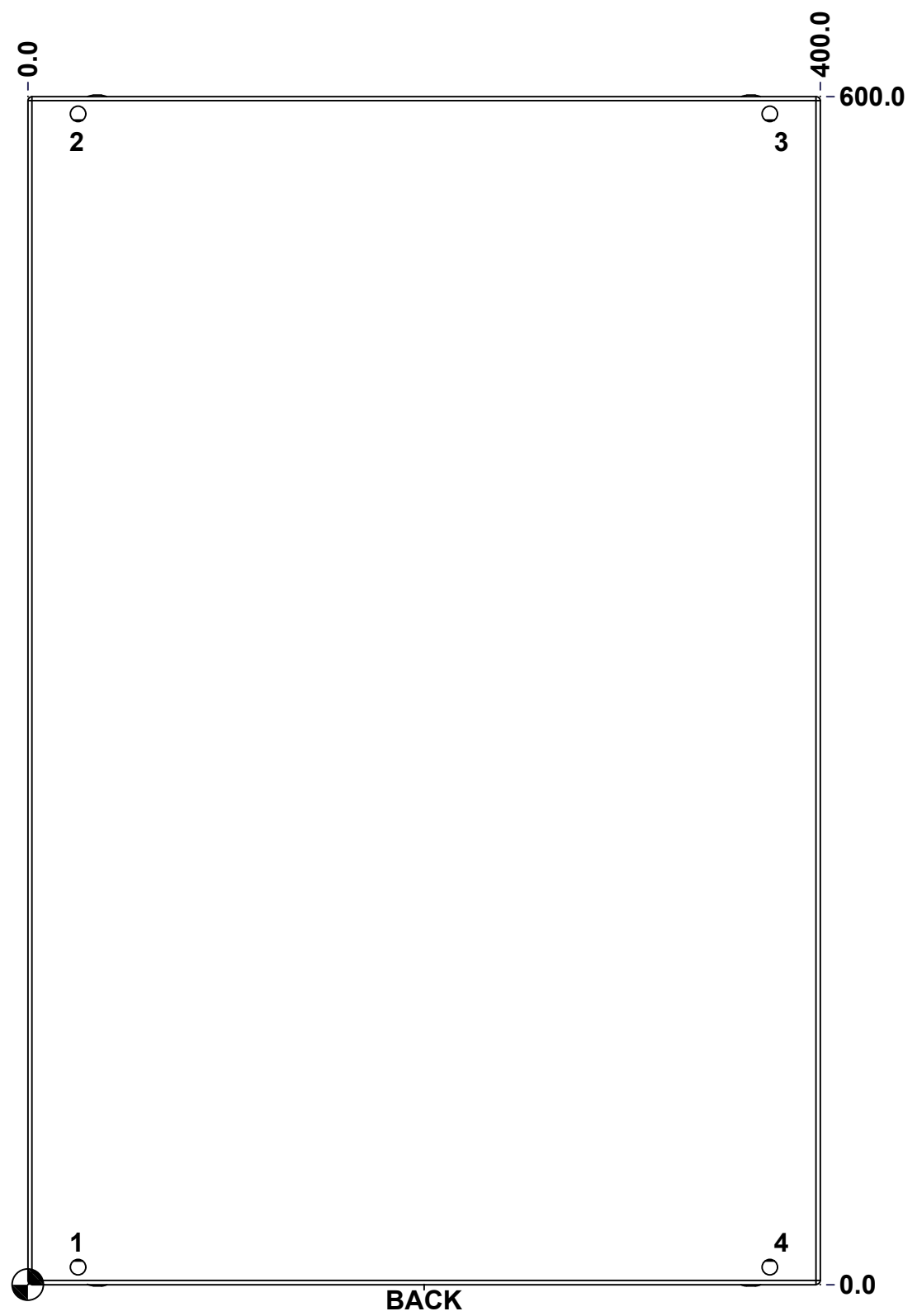

	Description 6412ESTB 600mm x 400mm x 120mm Body		Status (NULL)
	Part Number Numéro Pièce 6412ESTB604012B		Rev. 5 0 / 9

This drawing is confidential and must not be reproduced or used without the consent of EXM

Ce dessin est confidentiel et ne doit pas être reproduit ou utilisé sans le consentement de EXM

No.	Revisions	Date	By/Par

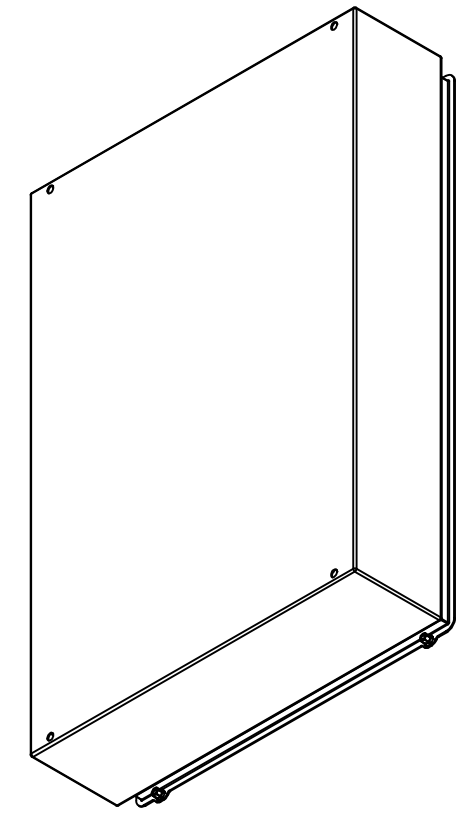

Isometric View

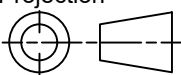

 Tél: (450) 979-4373 Fax: (450) 979-4626 www.exmweb.com	Flatness Aplatissement	Max 3.0mm
	Projection	
Customer Client	Date	
Drawn By Dessiné Par	BoxCad: BoxCad	Date 18-Apr-16
Material Matière	16 Ga Cold Rolled A1008 CS Type B (1.4mm)	
Color Couleur	Light Grey RAL7035	Finish Fini Textured
Description	Detail Rev.	
6412ESTB 600mm x 400mm x 127.9mm Body		
Part Number Numéro Pièce	Rev.	6
6412ESTB604012B	0	9

Qty	Part Number	Rev	Description
4	RIVET_NUT_M5_FH_OE	0	Rivet Nut M5 (Low Profile Open End)
1	6412ESTB604012B-P	0	6412ESTB 600mm x 400mm x 120mm Body Part
1	STK-P-03820R	0	Powder Paint (Light Grey / Rough Textured)
6	STK-Q-08350	5	Standoff M6 x 10mm
Parts List			

This drawing is confidential and must not be reproduced or used without the consent of EXM

Ce dessin est confidentiel et ne doit pas être reproduit ou utilisé sans le consentement de EXM

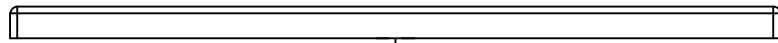

TOP

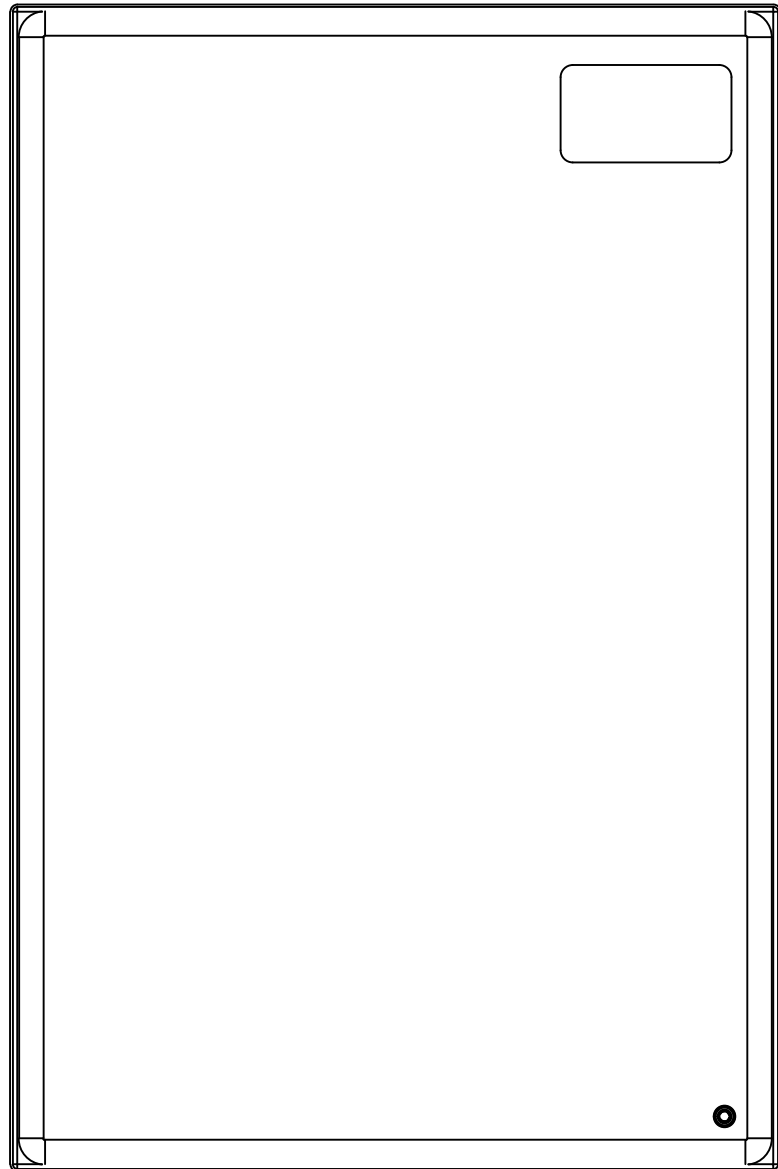

BACK

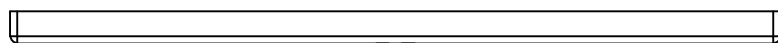

BOTTOM

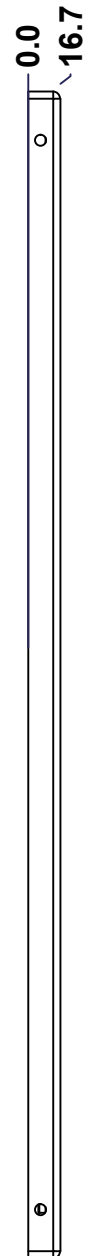

LEFT

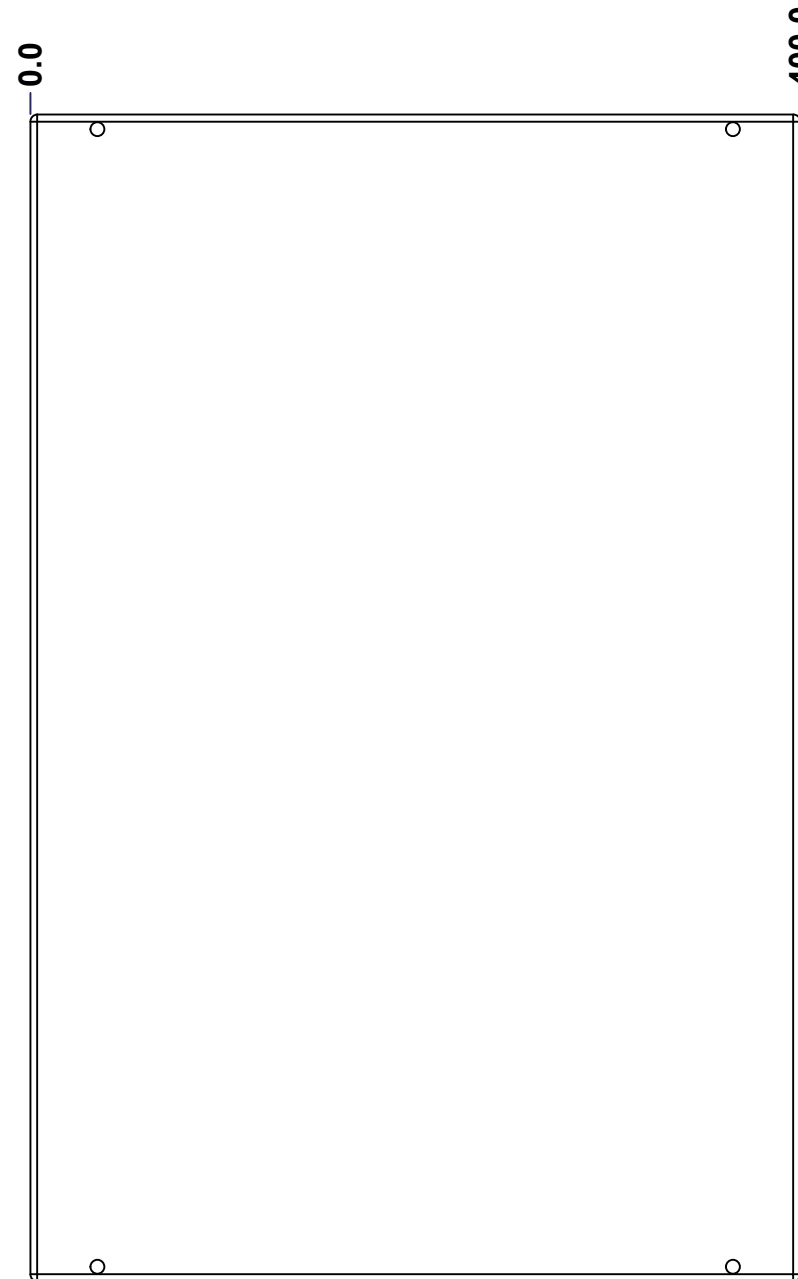

FRONT

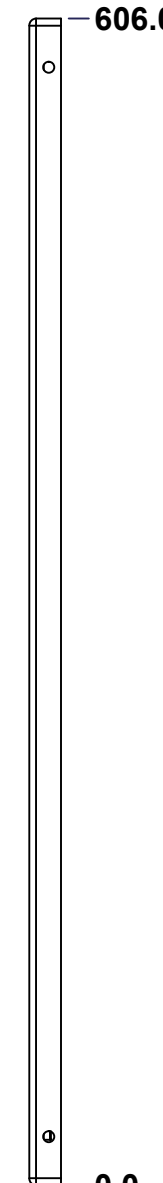

RIGHT

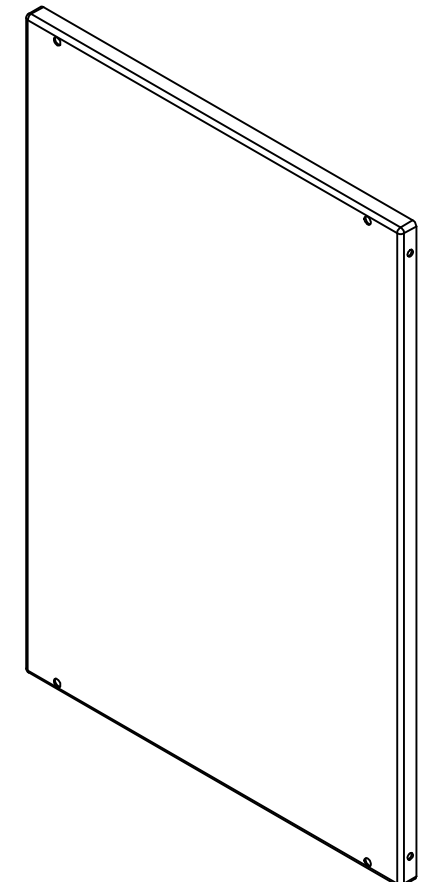

Isometric View

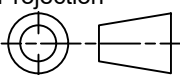

No.	Revisions	Date	By/Par

 Tél: (450) 979-4373 Fax: (450) 979-4626 www.exmweb.com		Flatness Aplatissement Max 3.0mm Projection 
Customer Client	Date	
Drawn By Dessiné Par	BoxCad: BoxCad	Date 18-Apr-16
Material Matière	16 Ga Cold Rolled A1008 CS Type B (1.4mm)	
Color Couleur	Light Grey RAL7035	Finish Fini Textured
Description		Detail Rev.
6412ESTB 600mm x 400mm Cover		
Part Number Numéro Pièce	Rev.	7
6412ESTB604012C	0	9

SEE BILL OF MATERIAL ON LAST PAGE

This drawing is confidential and must not be reproduced or used without the consent of EXM

Ce dessin est confidentiel et ne doit pas être reproduit ou utilisé sans le consentement de EXM

STANDARD FEATURES ARE NOT LISTED IN THIS HOLE TABLE			
HOLE TABLE - FRONT VIEW (CUSTOM FEATURE ONLY)			
CUT-OUT	XDIM	YDIM	DESCRIPTION
1	29.1	28.6	STANDOFF M6 x 10mm (Inside)
2	29.1	28.6	STANDOFF M6 x 10mm (Inside)
3	69.9	549.2	LABEL_EXM

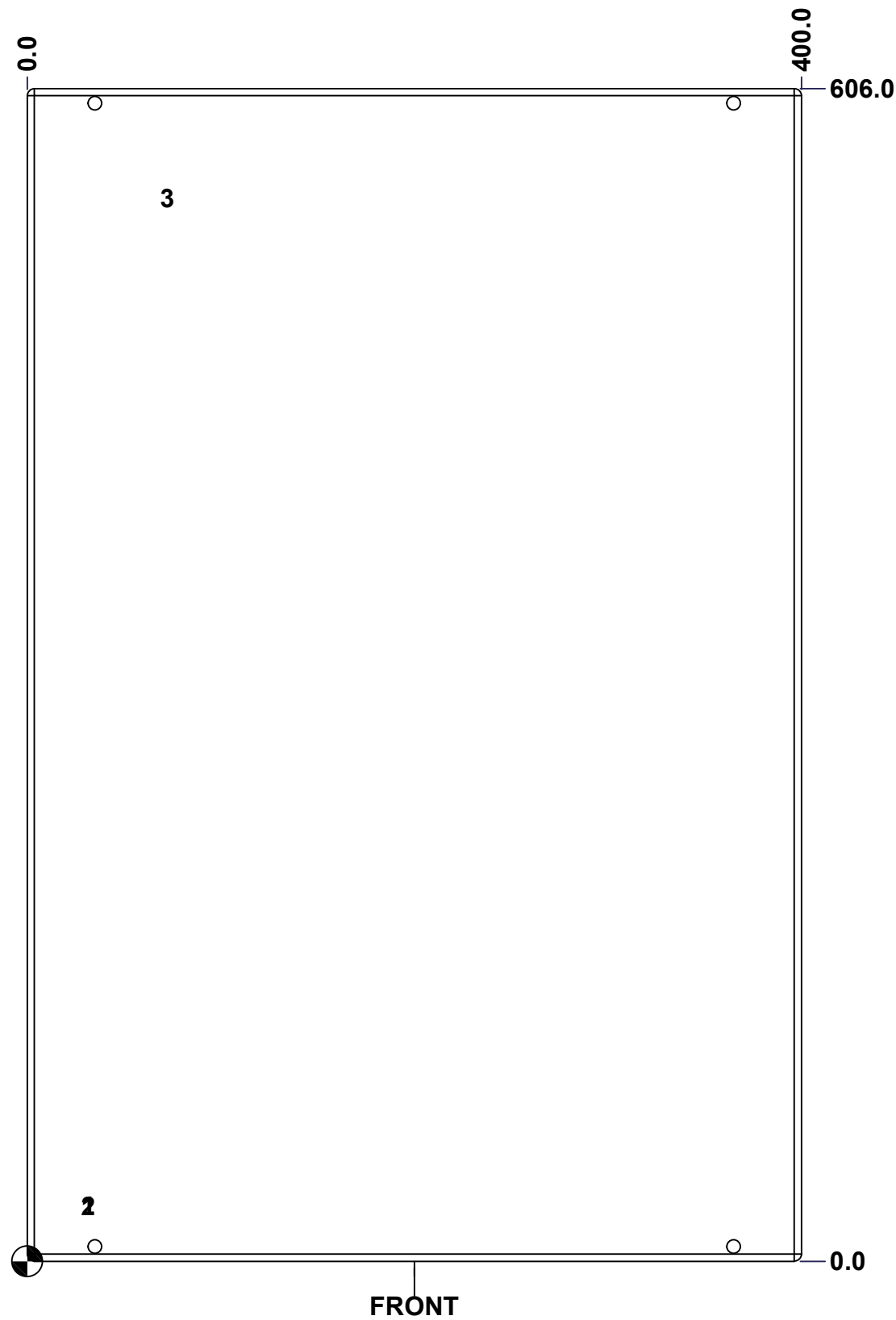

	Description	Status
	6412ESTB 600mm x 400mm Cover	(NULL)
Part Number Numéro Pièce 6412ESTB604012C	Rev.	8
	0	9

This drawing is confidential and must not be reproduced or used without the consent of EXM

Ce dessin est confidentiel et ne doit pas être reproduit ou utilisé sans le consentement de EXM

No.	Revisions	Date	By/Par

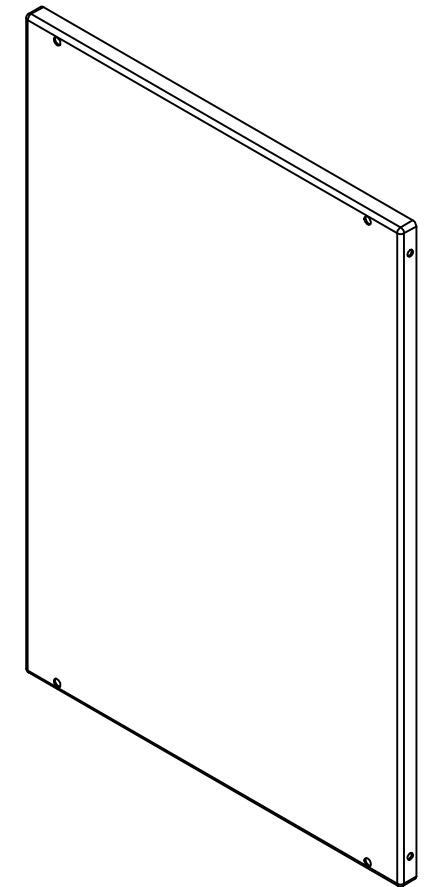

Isometric View

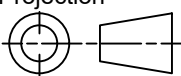

 Tél: (450) 979-4373 Fax: (450) 979-4626 www.exmweb.com		Flatness Aplatissement Max 3.0mm Projection 
Customer Client	Date	
Drawn By Dessiné Par	BoxCad: BoxCad	Date 18-Apr-16
Material Matière	16 Ga Cold Rolled A1008 CS Type B (1.4mm)	
Color Couleur	Light Grey RAL7035	Finish Fini Textured
Description		Detail Rev.
6412ESTB 600mm x 400mm Cover		
Part Number Numéro Pièce	Rev.	9
6412ESTB604012C	0	9

Qty	Part Number	Rev	Description
2	STK-Q-08350	5	Standoff M6 x 10mm
1	STK-P-03820R	0	Powder Paint (Light Grey / Rough Textured)
1	6412ESTB604012G	0	6412ESTB 600mm x 400mm Gasket
1	STK-S-00100	0	3.5" x 2" Silver Milar Flexcon Sticker
1	6412ESTB604012C-P	0	6412ESTB 600mm x 400mm Cover Part
Parts List			