

This drawing is confidential and must not be reproduced or used without the consent of EXM

Ce dessin est confidentiel et ne doit pas être reproduit ou utilisé sans le consentement de EXM

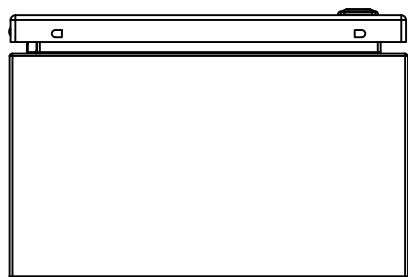

TOP

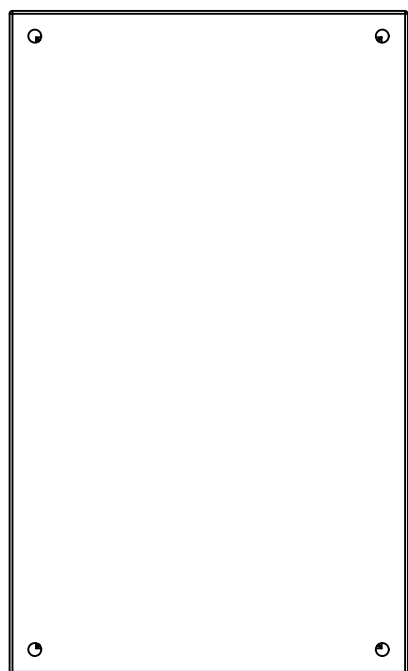

BACK

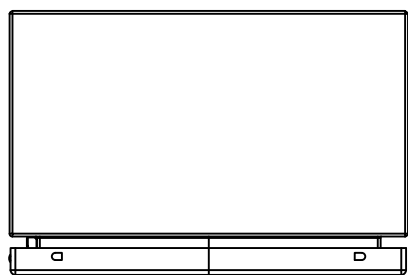

BOTTOM

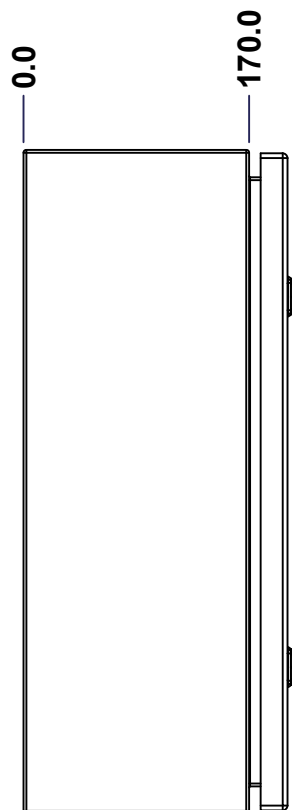

LEFT

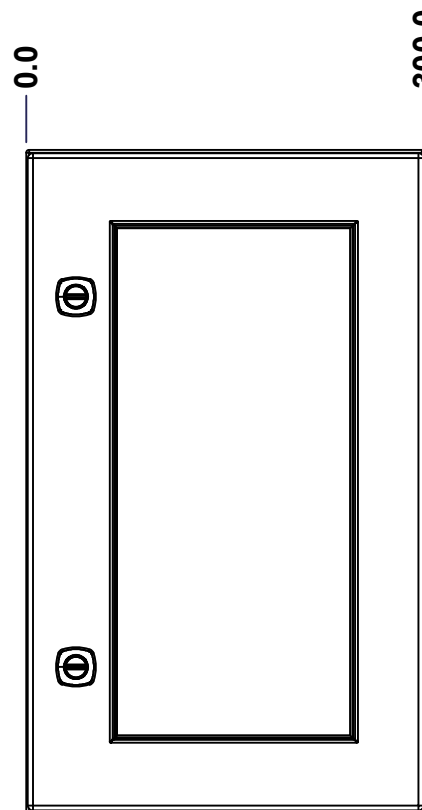

FRONT

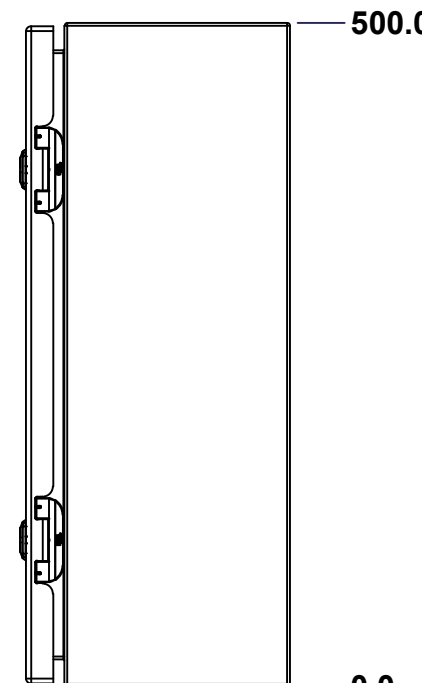

RIGHT

No.	Revisions	Date	By/Par

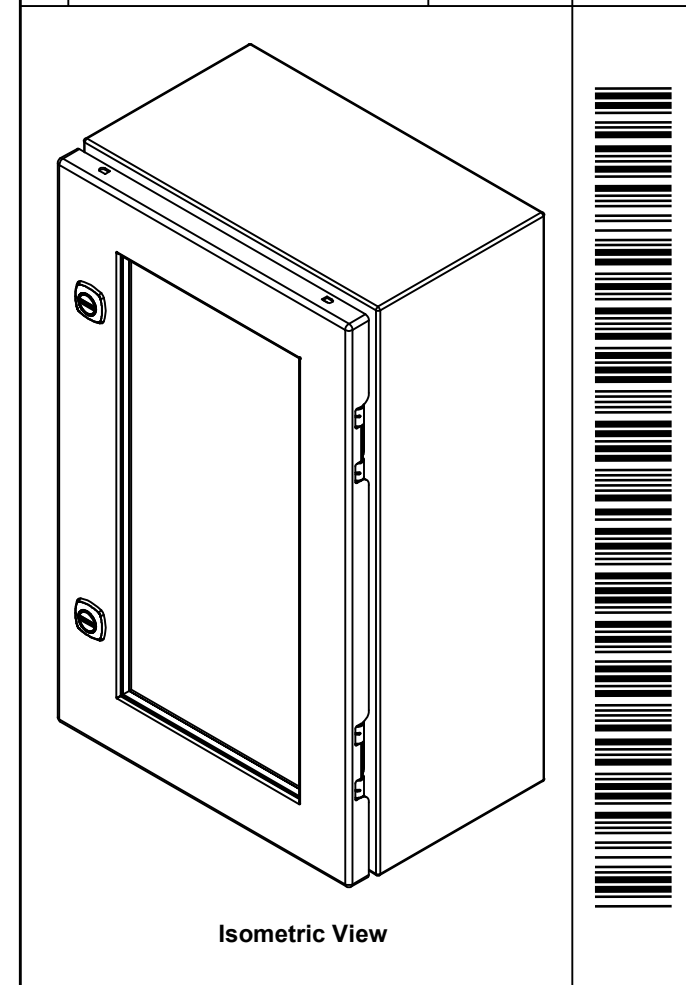

Isometric View

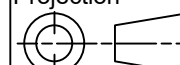
 Tél: (450) 979-4373 Fax: (450) 979-4626 www.exmweb.com		Flatness Aplatissement Max 3.0mm Projection 
Customer Client	Date	
Drawn By Dessiné Par	BoxCad: BoxCad	Date 15-Aug-14
Material Matière	16 Ga Cold Rolled A1008 CS Type B (1.4mm)	
Color Couleur	Light Grey RAL7035	Finish Fini Textured
Description	Detail Rev.	
6412ESW 500mm x 300mm x 170mm Assembly		
Part Number Numéro Pièce	Rev.	1
6412ESW030520	0	9

SEE BILL OF MATERIAL ON LAST PAGE

This drawing is confidential and must not be reproduced or used without the consent of EXM

Ce dessin est confidentiel et ne doit pas être reproduit ou utilisé sans le consentement de EXM

NOTE	
ITEM	DESCRIPTION
1	NEMA 4, 12 Enclosure (IP66)
2	C/W Standard ground studs on box and cover
3	W/O Standard door stiffener
4	C/W Standard inner panel (Included)
5	C/W Standard inner panel mounting studs

No.	Revisions	Date	By/Par

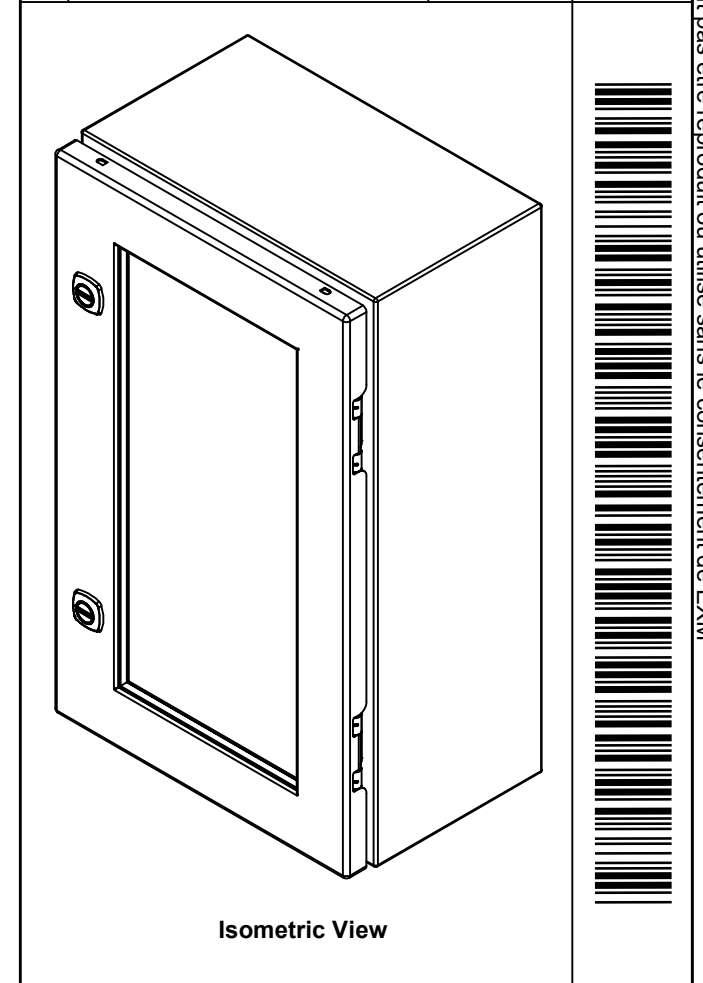



Tél: (450) 979-4373
Fax: (450) 979-4626
www.exmweb.com

Flatness
Aplatissement
Max 3.0mm

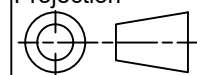
Projection

Customer Client	Date
Drawn By / Dessiné Par: BoxCad: BoxCad	Date: 15-Aug-14
Material / Matière: 16 Ga Cold Rolled A1008 CS Type B (1.4mm)	

PACKING		
ITEM	QTY	DESCRIPTION
Cardboard sleeve	2	Top and Bottom
Cardboard strip	2	Between back of enclosure and inner panel
Plastic bag	1	To protect cover surface and inside gasket
Plastic strap - Black	2	To Squeeze the 2 cardboard sleeve together
Packaging label	1	White label with product number

1	886 SP0305ES	0	886 SP - Inner Panel
2	STK-K-01320	0	5412 ES Inner Panel Accessory Kit
1	STK-K-01800	5	5412 ES Accessory Kit
1	6412ESW030520C	0	6412ESW 500mm x 300mm Cover
1	6412ESW030520B	0	6412ESW 500mm x 300mm x 170mm Body
2	STK-Q-04050-08	0	M6 x 8mm Hexagon Socket Head Machine Screw
Qty	Part Number	Rev	Description
Parts List			

Color / Couleur: Light Grey RAL7035	Finish / Fini: Textured
Description: 6412ESW 500mm x 300mm x 170mm Assembly	
Part Number / Numéro Pièce: 6412ESW030520	Rev. / Révis: 0
2 / 9	

This drawing is confidential and must not be reproduced or used without the consent of EXM

Ce dessin est confidentiel et ne doit pas être reproduit ou utilisé sans le consentement de EXM

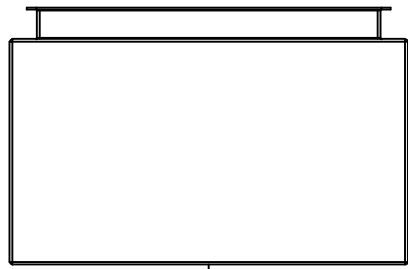

TOP

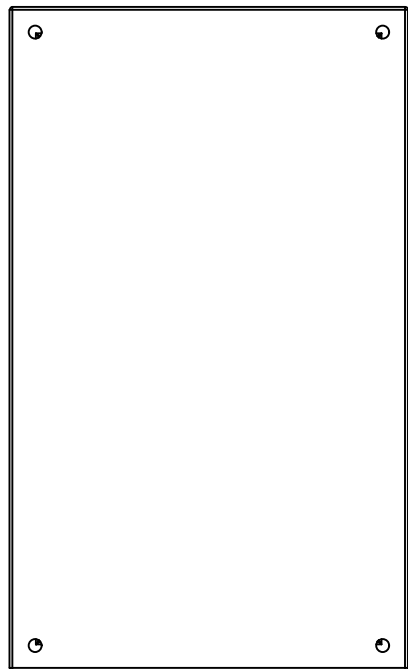

BACK

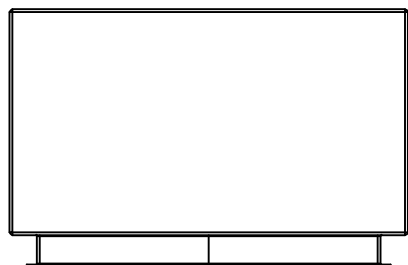

BOTTOM

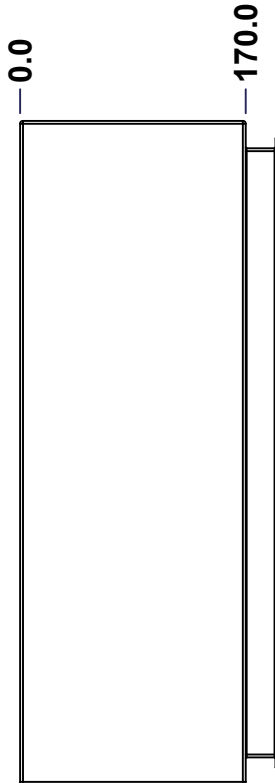

LEFT

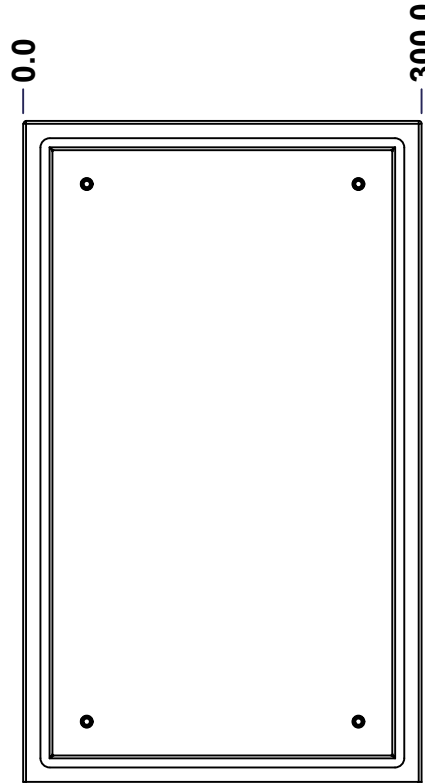

FRONT

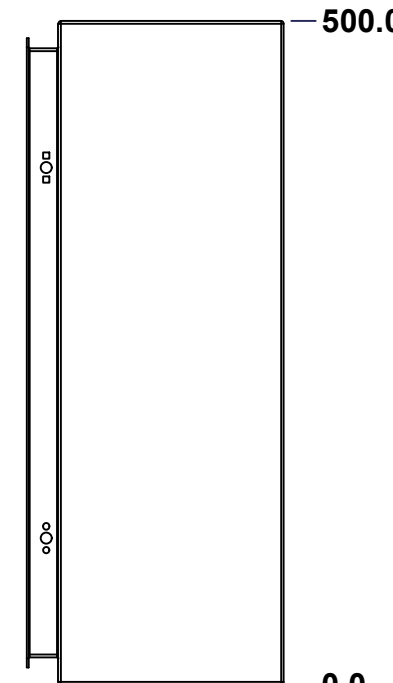

RIGHT

No.	Revisions	Date	By/Par

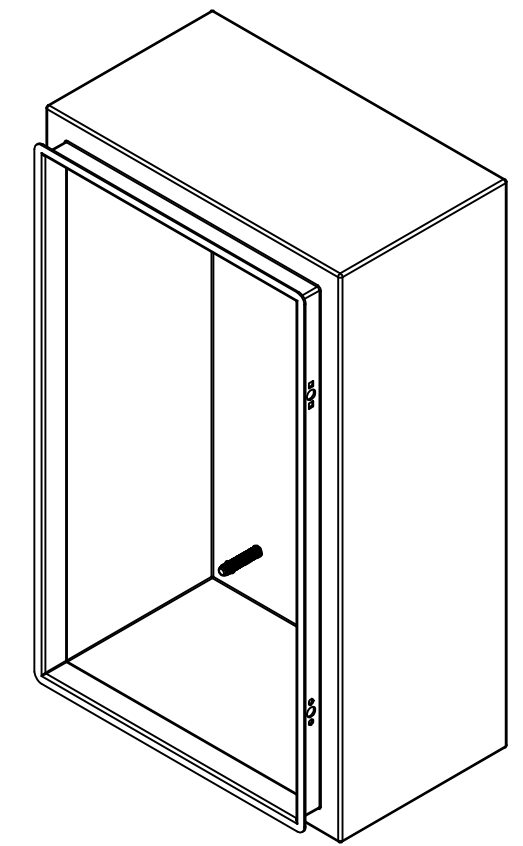

Isometric View

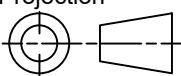

 Tél: (450) 979-4373 Fax: (450) 979-4626 www.exmweb.com		Flatness Aplatissement Max 3.0mm Projection 
Customer Client	Date	
Drawn By Dessiné Par	BoxCad: BoxCad	Date 15-Aug-14
Material Matière	16 Ga Cold Rolled A1008 CS Type B (1.4mm)	
Color Couleur	Light Grey RAL7035	Finish Fini Textured
Description		Detail Rev.
6412ESW 500mm x 300mm x 170mm Body		
Part Number Numéro Pièce	Rev.	3
	0	9

SEE BILL OF MATERIAL ON LAST PAGE

6412ESW030520B

This drawing is confidential and must not be reproduced or used without the consent of EXM

Ce dessin est confidentiel et ne doit pas être reproduit ou utilisé sans le consentement de EXM

STANDARD FEATURES ARE NOT LISTED IN THIS HOLE TABLE

HOLE TABLE - RIGHT VIEW (CUSTOM FEATURE ONLY)

CUT-OUT	XDIM	YDIM	DESCRIPTION
1	131.9	50.8	GND STUD M6 x 16mm (Inside)
2	119.2	449.2	LABEL_EXM (Inside)

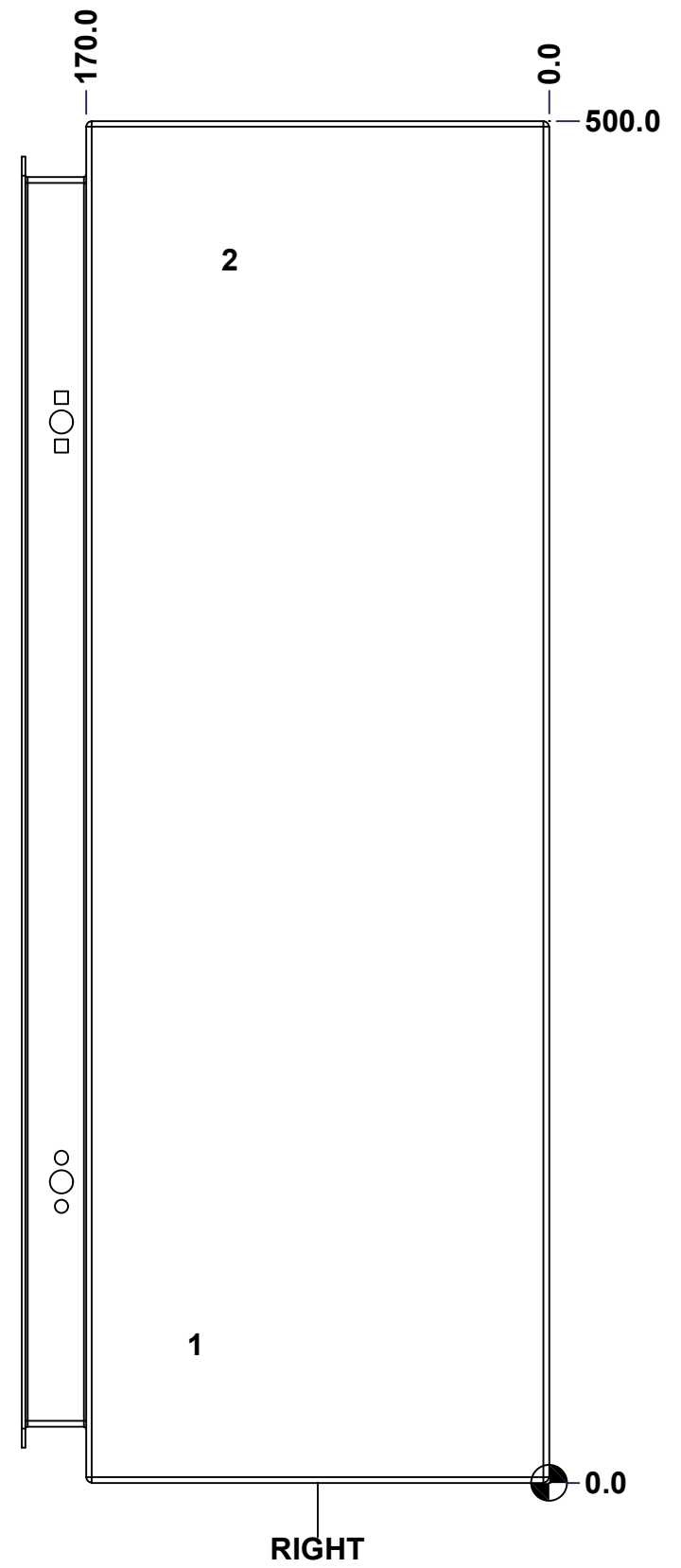

	Description		Status
	6412ESW 500mm x 300mm x 170mm Body		(NULL)
Part Number Numéro Pièce		Rev.	
6412ESW030520B		0	4 9

This drawing is confidential and must not be reproduced or used without the consent of EXM

Ce dessin est confidentiel et ne doit pas être reproduit ou utilisé sans le consentement de EXM

STANDARD FEATURES ARE NOT LISTED IN THIS HOLE TABLE

HOLE TABLE - BACK VIEW (CUSTOM FEATURE ONLY)

CUT-OUT	XDIM	YDIM	DESCRIPTION
1	47.6	47.6	IP STUD M8 x 35mm (Inside)
2	47.6	452.4	IP STUD M8 x 35mm (Inside)
3	252.4	452.4	IP STUD M8 x 35mm (Inside)
4	252.4	47.6	IP STUD M8 x 35mm (Inside)

5	280.9	19.1	RND Ø9.9
6	280.9	480.9	RND Ø9.9
7	19.1	480.9	RND Ø9.9
8	19.1	19.1	RND Ø9.9

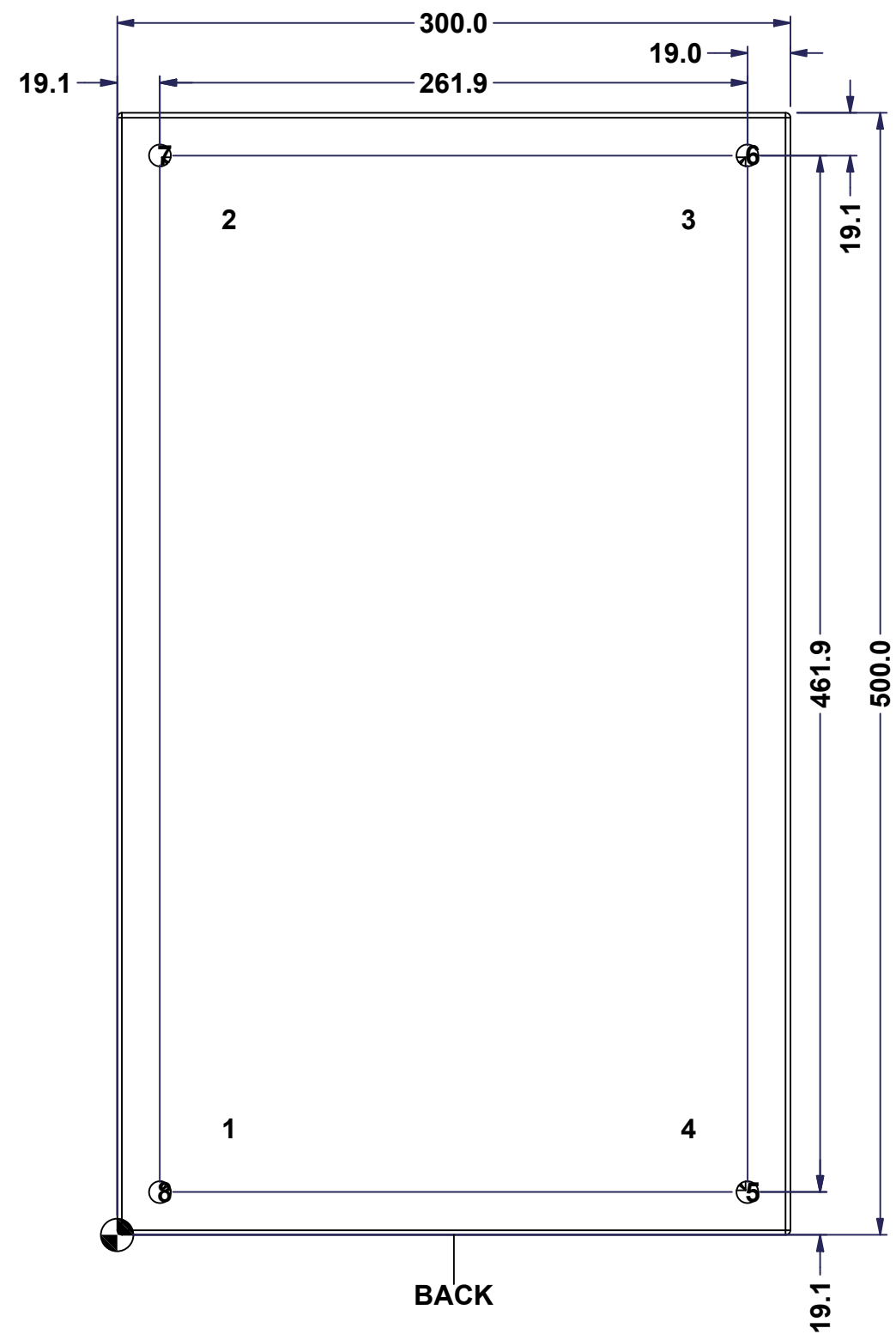

	Description 6412ESW 500mm x 300mm x 170mm Body	Status (NULL)
	Part Number Numéro Pièce 6412ESW030520B	Rev. 5 0

This drawing is confidential and must not be reproduced or used without the consent of EXM

Ce dessin est confidentiel et ne doit pas être reproduit ou utilisé sans le consentement de EXM

No.	Revisions	Date	By/Par

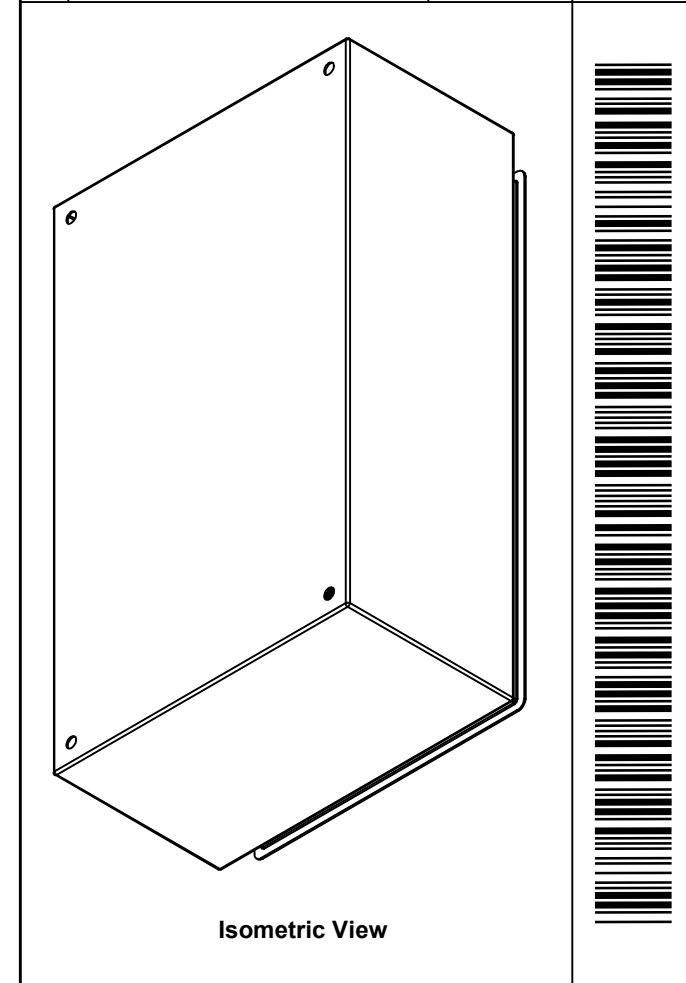

Tél: (450) 979-4373 Fax: (450) 979-4626 www.exmweb.com		Flatness Aplatissement Max 3.0mm Projection
Customer Client	Date	
Drawn By Dessiné Par	BoxCad: BoxCad	Date 15-Aug-14
Material Matière	16 Ga Cold Rolled A1008 CS Type B (1.4mm)	
Color Couleur	Light Grey RAL7035	Finish Fini Textured
Description		Detail Rev.
6412ESW 500mm x 300mm x 170mm Body		
Part Number Numéro Pièce	Rev.	6
6412ESW030520B	0	9

Qty	Part Number	Rev	Description
1	STK-S-00100	0	3.5" x 2" Silver Milar Flexcon Sticker
1	STK-Q-16080	0	Ground Stud M6 x 16mm Steel
1	STK-P-03820R	0	Powder Paint (Light Grey / Rough Textured)
4	STK-Q-16005	0	Stud M8 x 35mm Steel
1	6412ESW030520B-P	0	6412ESW 500mm x 300mm x 170mm Body Part
Parts List			

This drawing is confidential and must not be reproduced or used without the consent of EXM

Ce dessin est confidentiel et ne doit pas être reproduit ou utilisé sans le consentement de EXM

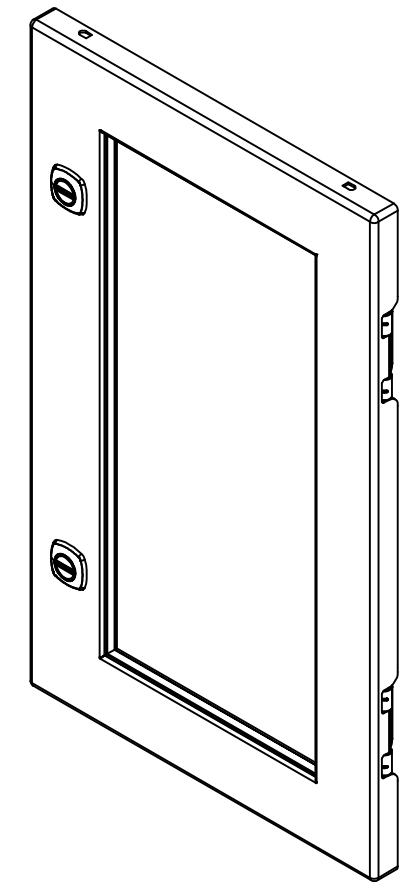
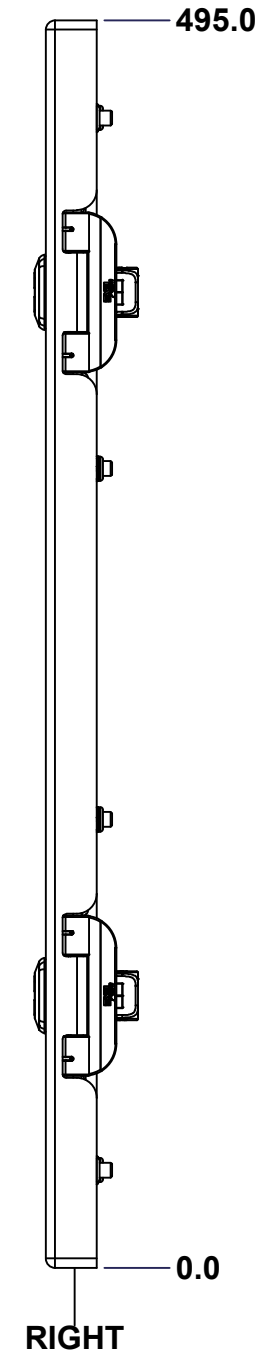
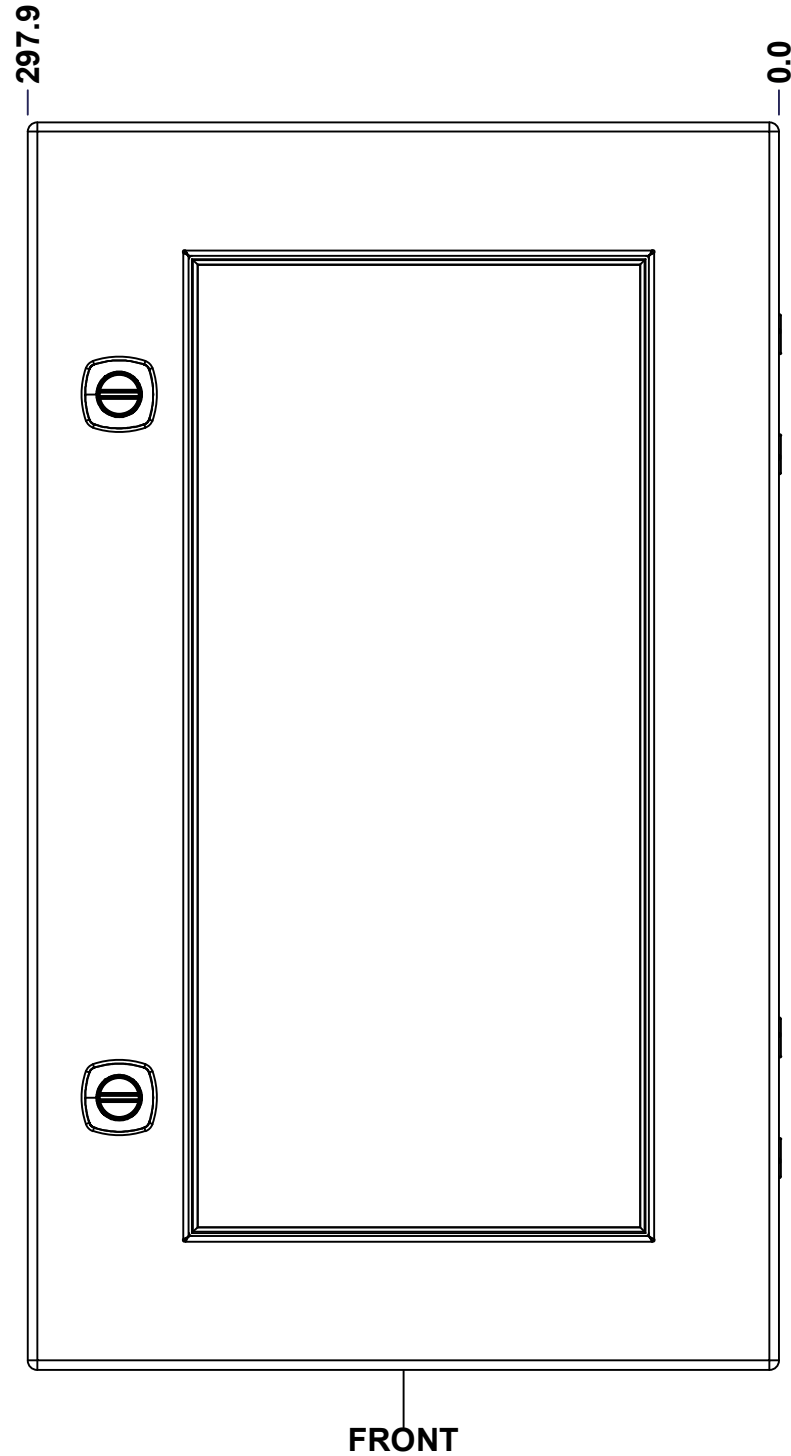
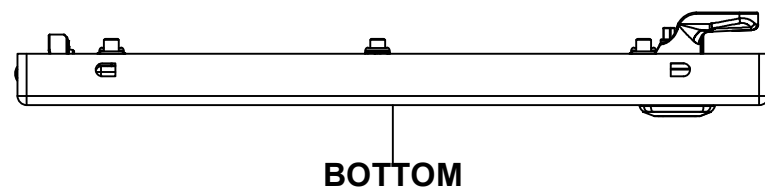
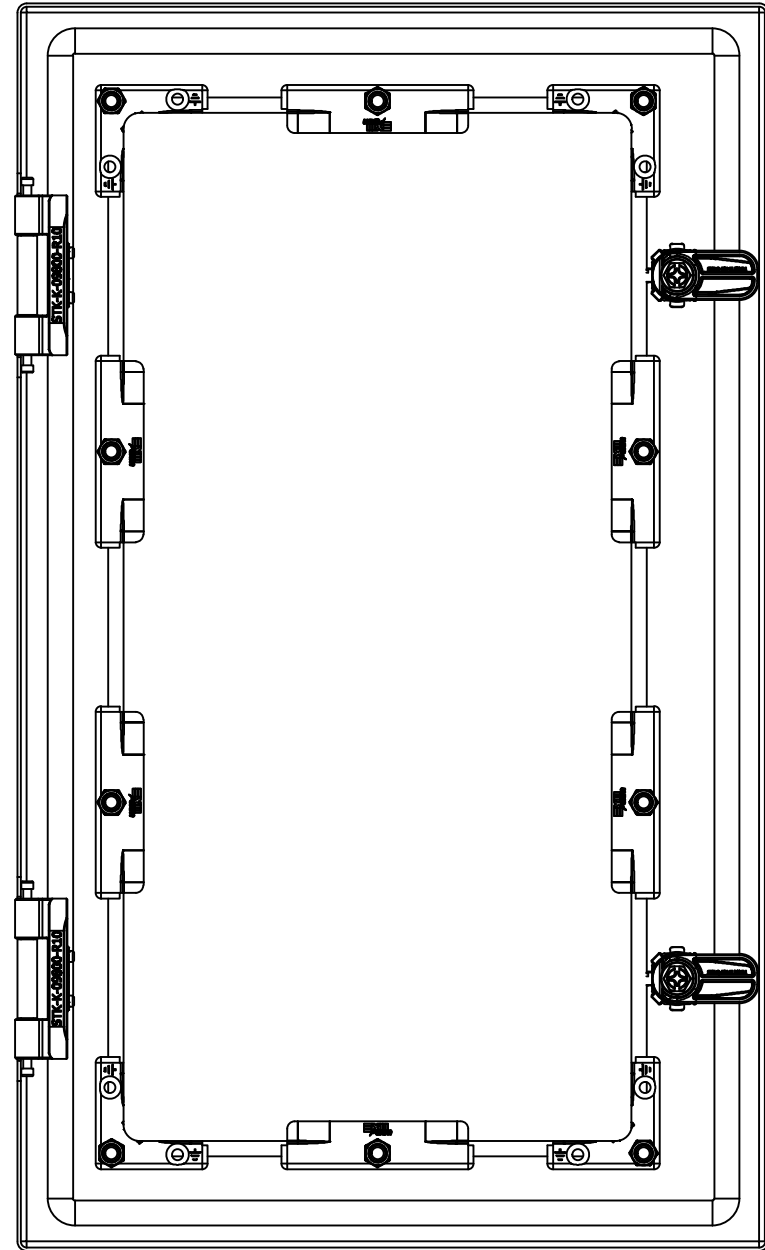
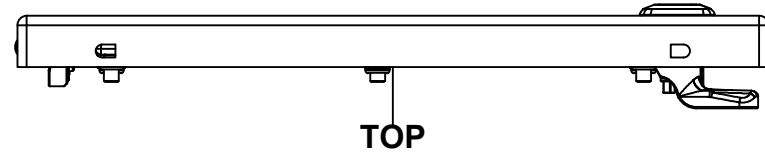

No.	Revisions	Date	By/Par

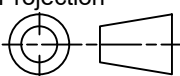
 Tél: (450) 979-4373 Fax: (450) 979-4626 www.exmweb.com		Flatness Aplatissement Max 3.0mm Projection 
Customer Client		Date
Drawn By Dessiné Par	BoxCad: BoxCad	Date 15-Aug-14
Material Matière	16 Ga Cold Rolled A1008 CS Type B (1.4mm)	
Color Couleur	Light Grey RAL7035	Finish Fini Textured
Description		Detail Rev.
6412ESW 500mm x 300mm Cover		
Part Number Numéro Pièce	Rev.	7
6412ESW030520C	0	9

SEE BILL OF MATERIAL ON LAST PAGE

This drawing is confidential and must not be reproduced or used without the consent of EXM

Ce dessin est confidentiel et ne doit pas être reproduit ou utilisé sans le consentement de EXM

STANDARD FEATURES ARE NOT LISTED IN THIS HOLE TABLE

HOLE TABLE - FRONT VIEW (CUSTOM FEATURE ONLY)

CUT-OUT	XDIM	YDIM	DESCRIPTION
1	37.3	177.9	STUD M6 x 25mm (Inside)
2	248.4	177.9	STUD M6 x 25mm (Inside)
3	37.3	317.1	STUD M6 x 25mm (Inside)
4	248.4	317.1	STUD M6 x 25mm (Inside)
5	37.3	456.2	STUD M6 x 25mm (Inside)
6	37.3	38.8	STUD M6 x 25mm (Inside)
7	142.8	456.2	STUD M6 x 25mm (Inside)
8	142.8	38.8	STUD M6 x 25mm (Inside)
9	248.4	456.2	STUD M6 x 25mm (Inside)
10	248.4	38.8	STUD M6 x 25mm (Inside)

11	261.7	387.0	LOCK 880 SCQ4-SL @ 180.0°
12	261.7	108.0	LOCK 880 SCQ4-SL @ 180.0°

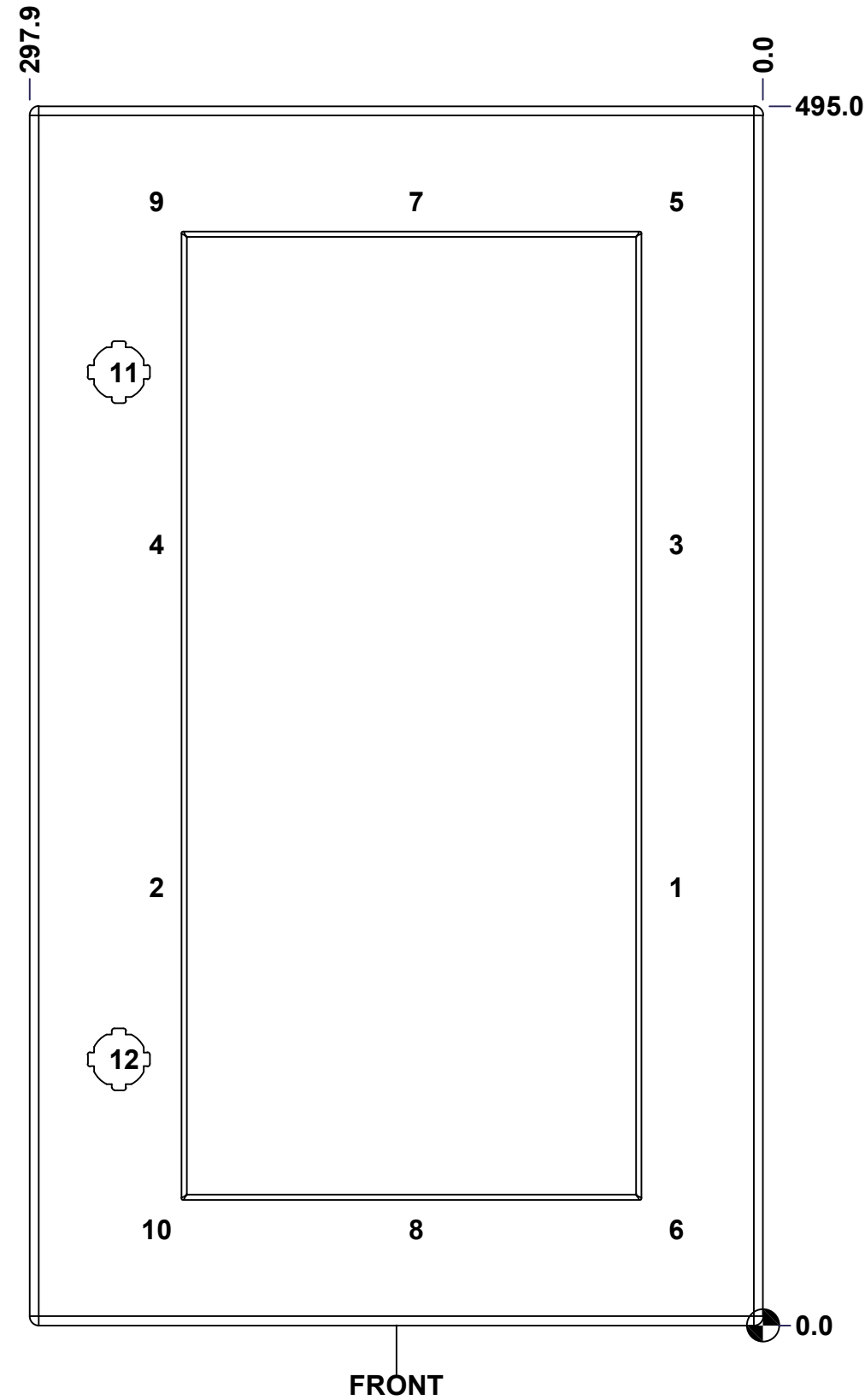

FRONT

	Description	Status
	6412ESW 500mm x 300mm Cover	(NULL)
	Part Number Numéro Pièce	Rev.
	6412ESW030520C	0
		8
		9

This drawing is confidential and must not be reproduced or used without the consent of EXM

Ce dessin est confidentiel et ne doit pas être reproduit ou utilisé sans le consentement de EXM

No.	Revisions	Date	By/Par

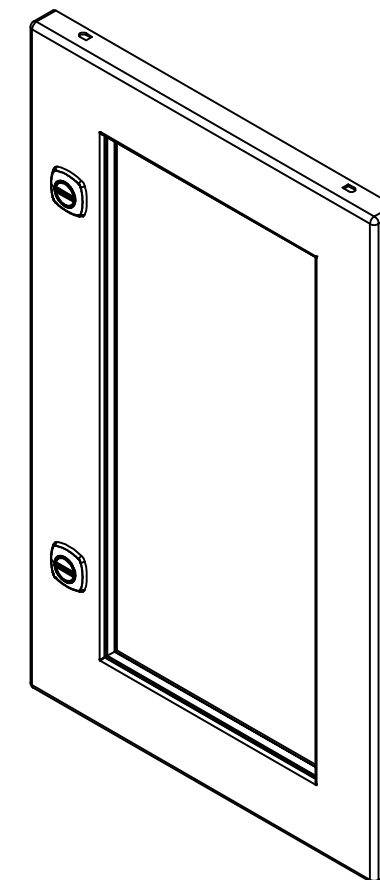

Isometric View



2	STK-K-12500	19	5412 ES 1/4 Turn Lock
1	STK-P-03820R	0	Powder Paint (Light Grey / Rough Textured)
1	STK-A-60703	0	5412 ESW Lexan Bracket Kit
10	STK-Q-16012	0	Stud M6 x 25mm Steel
1	STK-G-02710	0	880 HWKG - Windows Kit Gasket
1	6412ESW030520LXG	0	6412ESW 500mm x 300mm Lexan Gasket Part
1	6412ESW030520LX	0	6412ESW 407.9mm x 201.6mm Lexan Part
1	6412ESW030520G	0	6412ESW 500mm x 300mm Cover Gasket Part
1	6412ESW030520C-P	0	6412ESW 500mm x 300mm Cover Part
2	STK-K-09800		5412 ES Hinge with 2 Captive Hinge Pins
6	STK-Q-60701	2.1	880 WK - Lexan 1/4" Fixing Bracket
QTY	Part Number	Rev	Description
Parts List			



Tél: (450) 979-4373
 Fax: (450) 979-4626
www.exmweb.com

Flatness
Aplatissement
Max 3.0mm

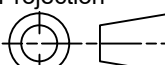
Projection

Customer Client	Date
Drawn By Dessiné Par BoxCad: BoxCad	Date 15-Aug-14
Material Matière 16 Ga Cold Rolled A1008 CS Type B (1.4mm)	
Color Couleur Light Grey RAL7035	Finish Fini Textured
Description 6412ESW 500mm x 300mm Cover	Detail Rev.
Part Number Numéro Pièce 6412ESW030520C	Rev. 9 0

This drawing is confidential and must not be reproduced or used without the consent of EXM

Ce dessin est confidentiel et ne doit pas être reproduit ou utilisé sans le consentement de EXM

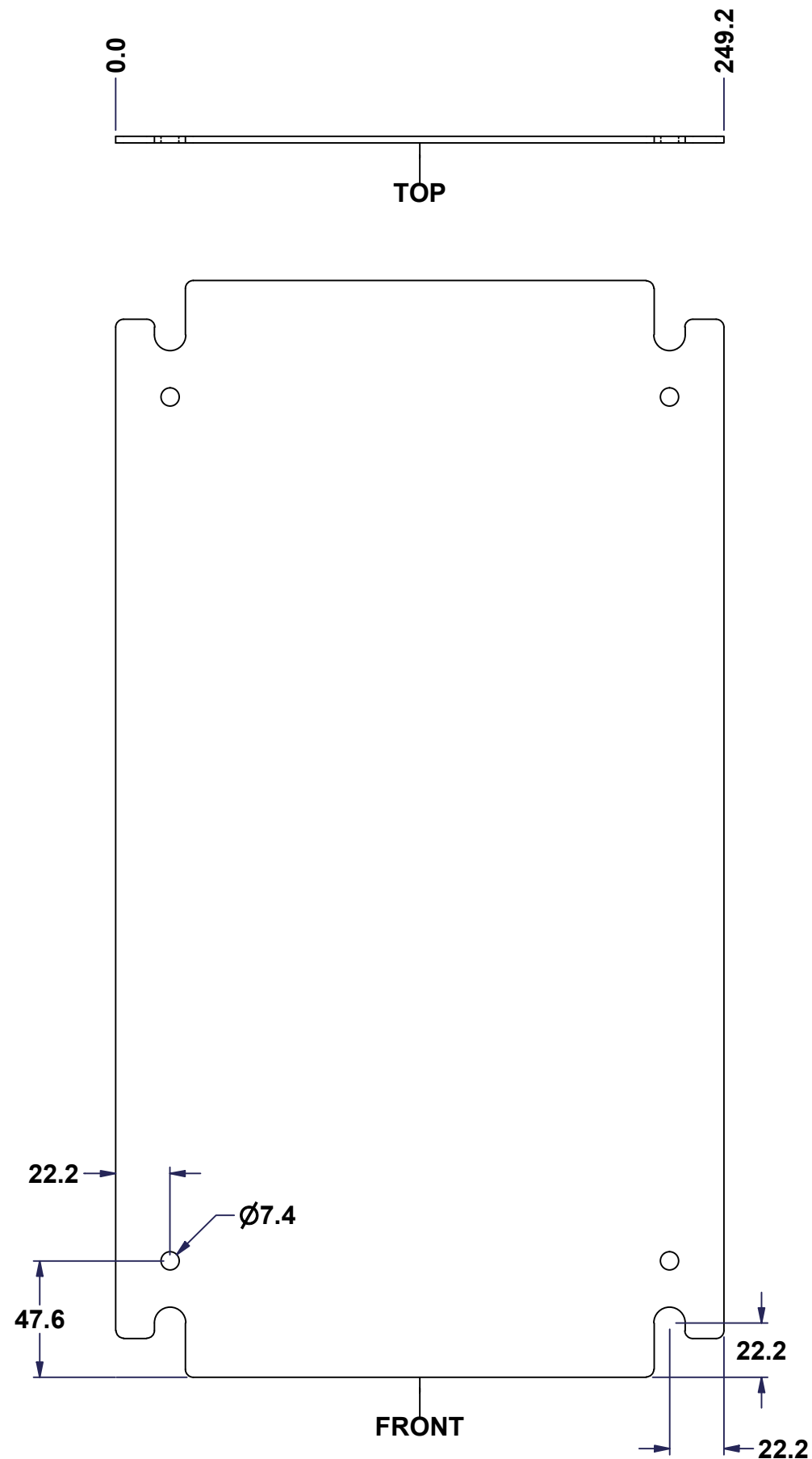

No.	Revisions	Date	By/Par

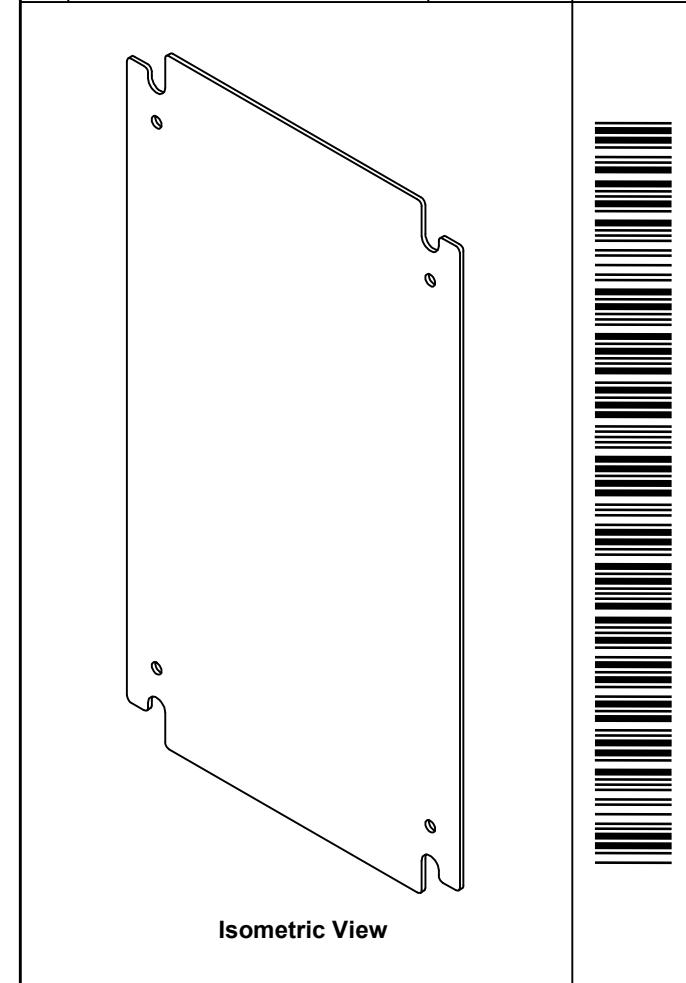

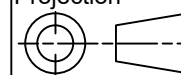
 Tél: (450) 979-4373 Fax: (450) 979-4626 www.exmweb.com		Flatness Aplatissement Max 3.0mm
Projection 		
Customer Client	Date	
Drawn By Dessiné Par	BoxCad	Date 23-Jan-07
Material Matière	12 Ga Galvanized (2.5mm)	
Color Couleur	Unpainted	Finish Fini Unpainted
Description	Detail Rev.	
886 SP - Inner Panel		
Part Number Numéro Pièce	Rev.	1 2
886 SP0305ES	0	

SEE BILL OF MATERIAL ON LAST PAGE

This drawing is confidential and must not be reproduced or used without the consent of EXM

Ce dessin est confidentiel et ne doit pas être reproduit ou utilisé sans le consentement de EXM

No.	Revisions	Date	By/Par

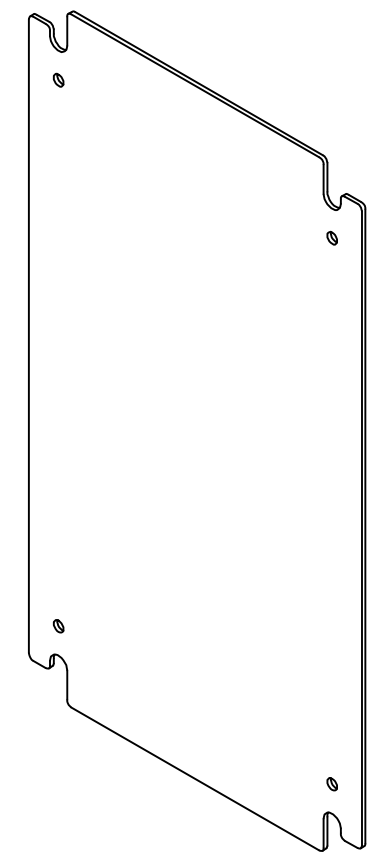

Isometric View



 Tél: (450) 979-4373 Fax: (450) 979-4626 www.exmweb.com		Flatness Aplatissement Max 3.0mm
Customer Client		Date
Drawn By / Dessiné Par: BoxCad		Date: 23-Jan-07
Material / Matière: 12 Ga Galvanized (2.5mm)		
Color / Couleur: Unpainted	Finish / Fini: Unpainted	
Description: 886 SP - Inner Panel		Detail Rev.
Part Number / Numéro Pièce: 886 SP0305ES		Rev. 0 / 2

Qty	Part Number	Rev	Description
1	886 SP0305ES-P	0	886 SP - Inner Panel Part
Parts List			