

This drawing is confidential and must not be reproduced or used without the consent of EXM

Ce dessin est confidentiel et ne doit pas être reproduit ou utilisé sans le consentement de EXM

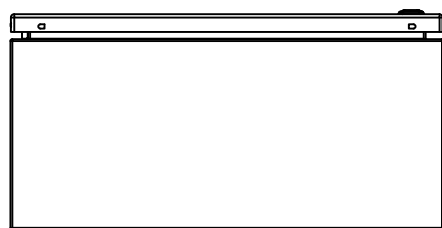

TOP

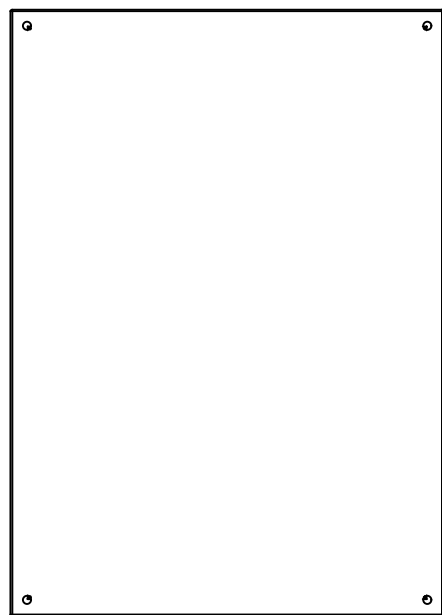

BACK

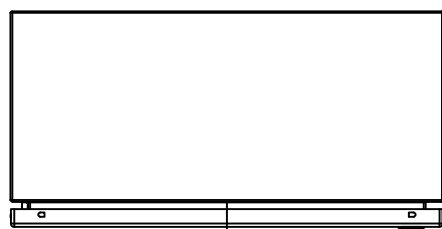

BOTTOM

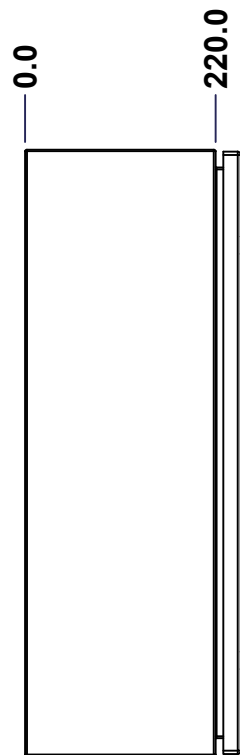

LEFT

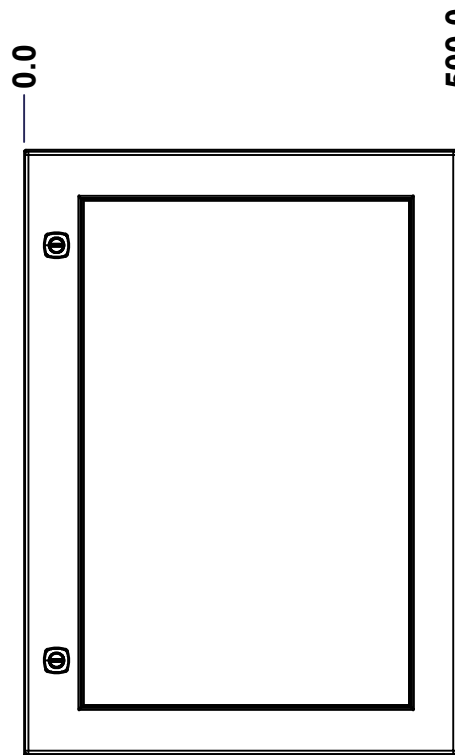

FRONT

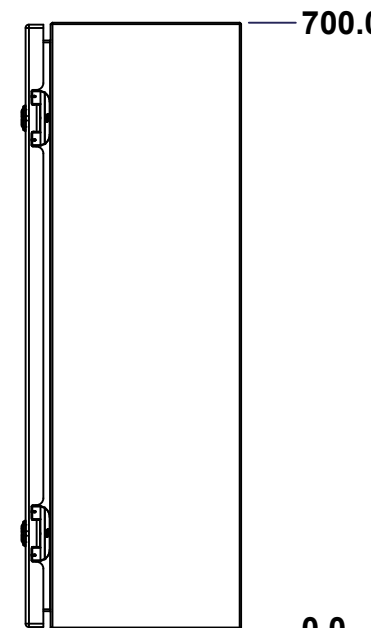

RIGHT

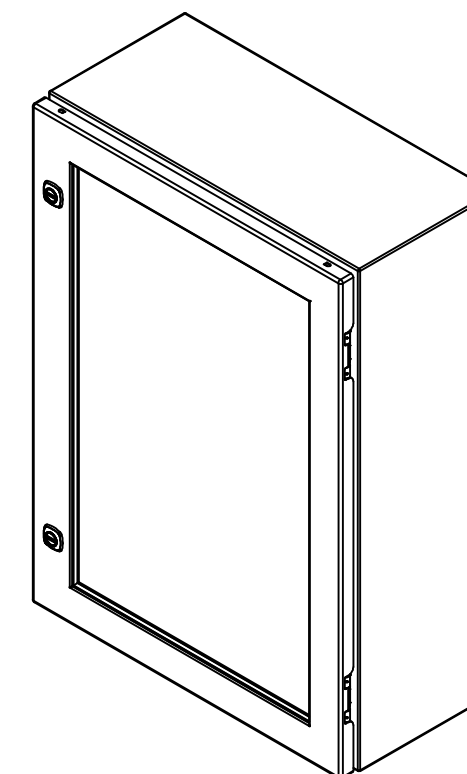

Isometric View

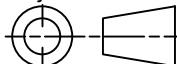

No.	Revisions	Date	By/Par

 Tél: (450) 979-4373 Fax: (450) 979-4626 www.exmweb.com		Flatness Aplatissement Max 3.0mm Projection 
Customer Client	Date	
Drawn By Dessiné Par	BoxCad: BoxCad	Date 14-Aug-14
Material Matière	16 Ga Cold Rolled A1008 CS Type B (1.4mm)	
Color Couleur	Light Grey RAL7035	Finish Fini Textured
Description	Detail Rev.	
6412ESW 700mm x 500mm x 220mm Assembly		
Part Number Numéro Pièce	Rev.	1
6412ESW050725	0	9

SEE BILL OF MATERIAL ON LAST PAGE

This drawing is confidential and must not be reproduced or used without the consent of EXM

Ce dessin est confidentiel et ne doit pas être reproduit ou utilisé sans le consentement de EXM

NOTE	
ITEM	DESCRIPTION
1	NEMA 4, 12 Enclosure (IP66)
2	C/W Standard ground studs on box and cover
3	W/O Standard door stiffener
4	C/W Standard inner panel (Included)
5	C/W Standard inner panel mounting studs

No.	Revisions	Date	By/Par

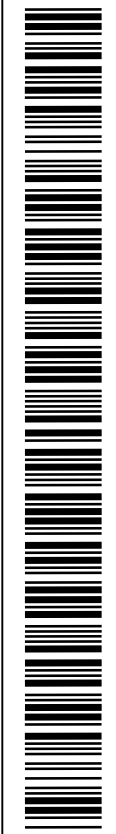
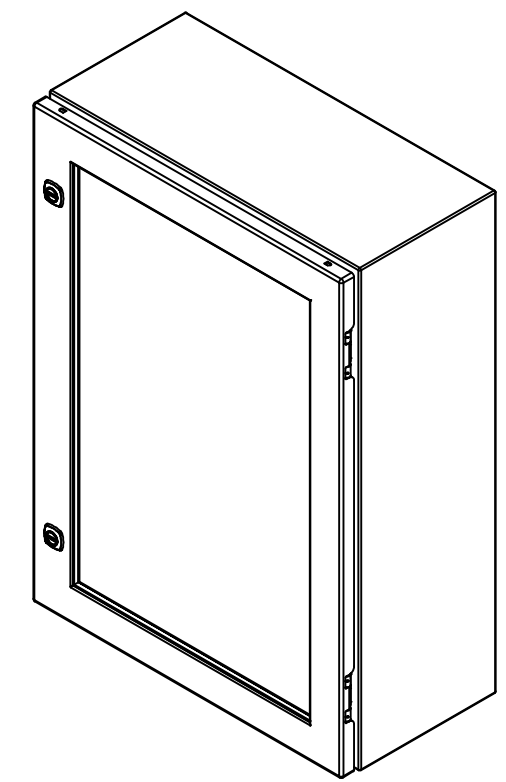

Isometric View

EXM
www.exmweb.com

Tél: (450) 979-4373
Fax: (450) 979-4626

Flatness
Aplatissement
Max 3.0mm

Projection

Customer Client	Date
Drawn By Dessiné Par BoxCad: BoxCad	Date 14-Aug-14
Material Matière 16 Ga Cold Rolled A1008 CS Type B (1.4mm)	

Color Couleur Light Grey RAL7035	Finish Fini Textured
Description 6412ESW 700mm x 500mm x 220mm Assembly	Detail Rev.
Part Number Numéro Pièce 6412ESW050725	Rev. 0

PACKING		
ITEM	QTY	DESCRIPTION
Cardboard sleeve	2	Top and Bottom
Cardboard strip	2	Between back of enclosure and inner panel
Plastic bag	1	To protect cover surface and inside gasket
Plastic strap - Black	2	To Squeeze the 2 cardboard sleeve together
Packaging label	1	White label with product number

Qty	Part Number	Rev	Description
1	886 SP0507ES	0	886 SP - Inner Panel
2	STK-K-01320	0	5412 ES Inner Panel Accessory Kit
1	STK-K-01800	5	5412 ES Accessory Kit
1	6412ESW050725C	0	6412ESW 700mm x 500mm Cover
1	6412ESW050725B	0	6412ESW 700mm x 500mm x 220mm Body
2	STK-Q-04050-08	0	M6 x 8mm Hexagon Socket Head Machine Screw

Parts List

This drawing is confidential and must not be reproduced or used without the consent of EXM

Ce dessin est confidentiel et ne doit pas être reproduit ou utilisé sans le consentement de EXM



TOP

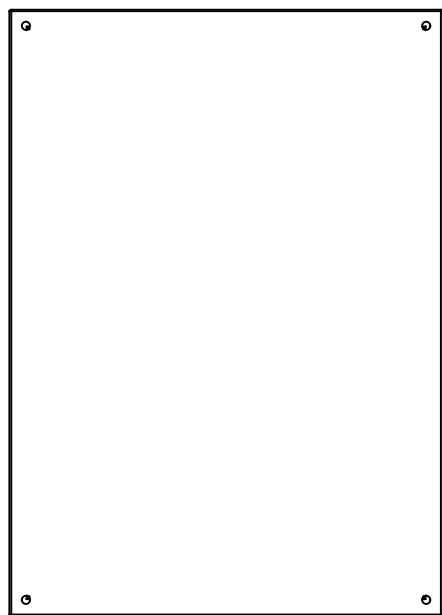

BACK

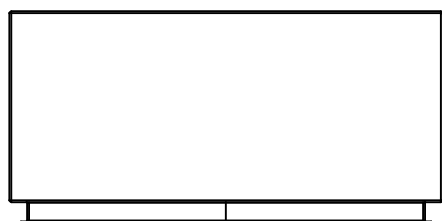

BOTTOM

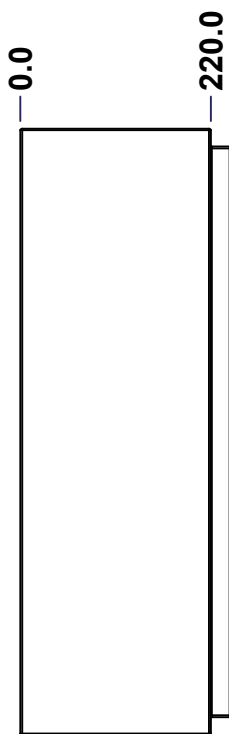

LEFT

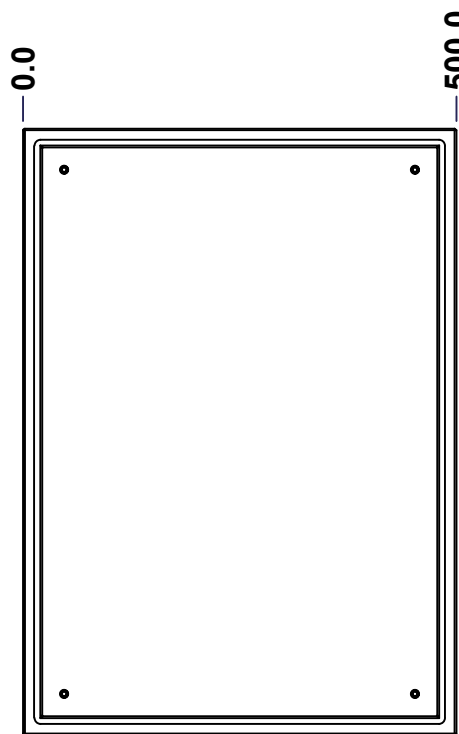

FRONT

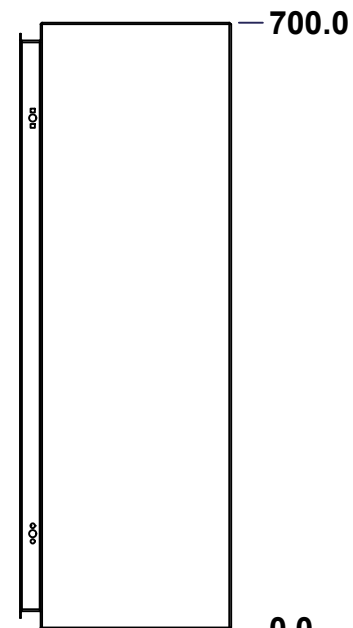

RIGHT

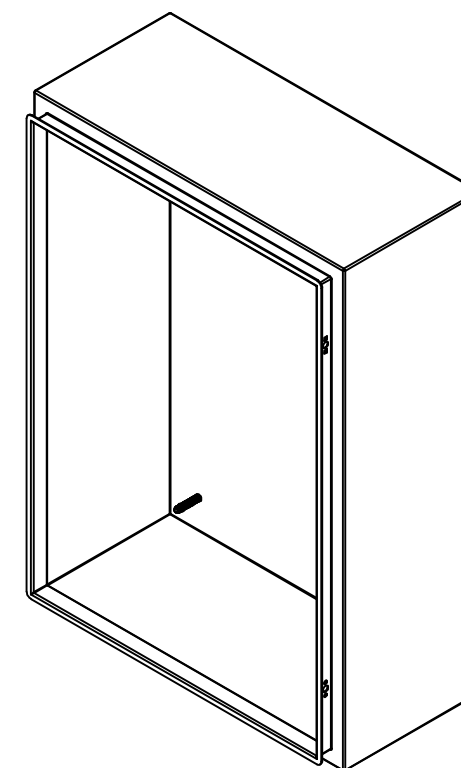

Isometric View

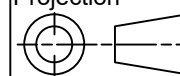

No.	Revisions	Date	By/Par

 Tél: (450) 979-4373 Fax: (450) 979-4626 www.exmweb.com		Flatness Aplatissement Max 3.0mm Projection 
Customer Client	Date	
Drawn By Dessiné Par	BoxCad: BoxCad	Date 14-Aug-14
Material Matière	16 Ga Cold Rolled A1008 CS Type B (1.4mm)	
Color Couleur	Light Grey RAL7035	Finish Fini Textured
Description 6412ESW 700mm x 500mm x 220mm Body		Detail Rev.
Part Number Numéro Pièce	6412ESW050725B	Rev. 3 0 9

SEE BILL OF MATERIAL ON LAST PAGE

This drawing is confidential and must not be reproduced or used without the consent of EXM

Ce dessin est confidentiel et ne doit pas être reproduit ou utilisé sans le consentement de EXM

STANDARD FEATURES ARE NOT LISTED IN THIS HOLE TABLE

HOLE TABLE - RIGHT VIEW (CUSTOM FEATURE ONLY)

CUT-OUT	XDIM	YDIM	DESCRIPTION
1	181.9	50.8	GND STUD M6 x 16mm (Inside)
2	169.2	649.2	LABEL_EXM (Inside)

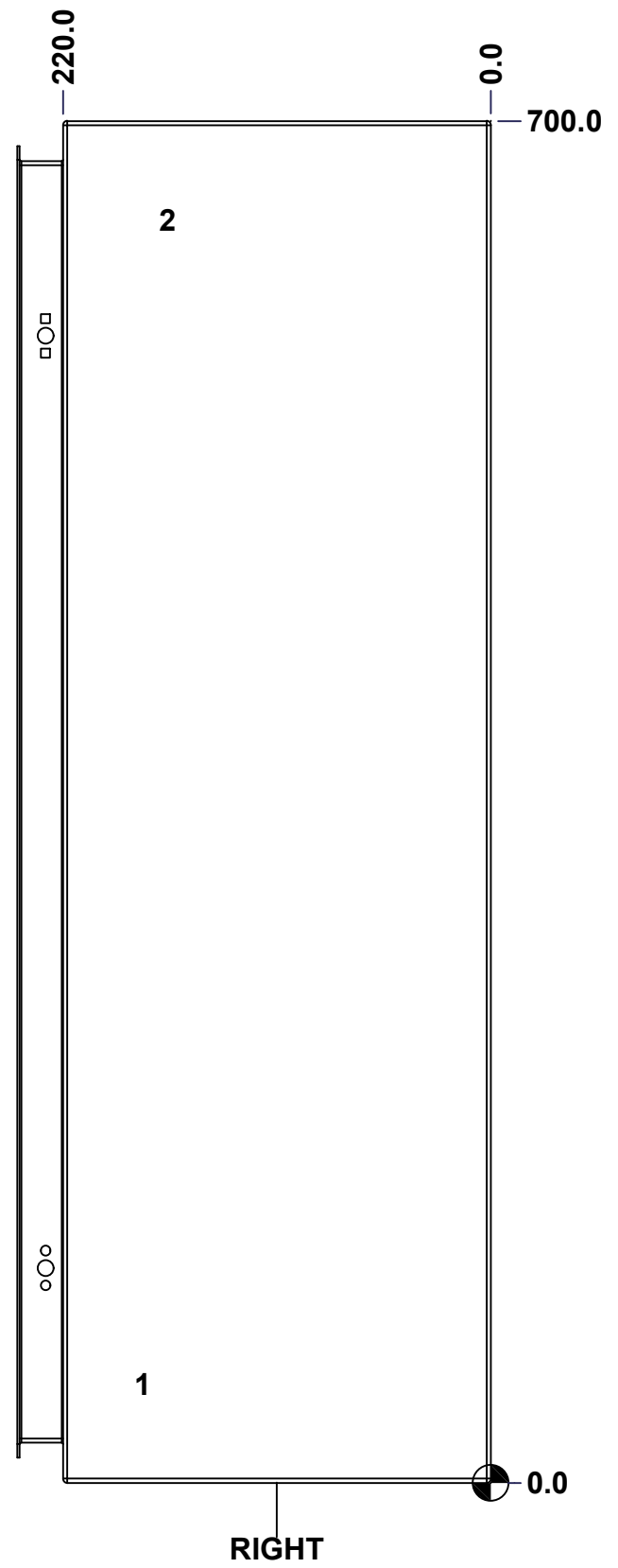

	Description		Status
	6412ESW 700mm x 500mm x 220mm Body		(NULL)
Part Number Numéro Pièce		Rev.	
6412ESW050725B		0	4 9

This drawing is confidential and must not be reproduced or used without the consent of EXM

Ce dessin est confidentiel et ne doit pas être reproduit ou utilisé sans le consentement de EXM

STANDARD FEATURES ARE NOT LISTED IN THIS HOLE TABLE

HOLE TABLE - BACK VIEW (CUSTOM FEATURE ONLY)

CUT-OUT	XDIM	YDIM	DESCRIPTION
1	47.6	47.6	IP STUD M8 x 35mm (Inside)
2	47.6	652.4	IP STUD M8 x 35mm (Inside)
3	452.4	652.4	IP STUD M8 x 35mm (Inside)
4	452.4	47.6	IP STUD M8 x 35mm (Inside)

5	480.9	19.1	RND Ø9.9
6	480.9	680.9	RND Ø9.9
7	19.1	680.9	RND Ø9.9
8	19.1	19.1	RND Ø9.9

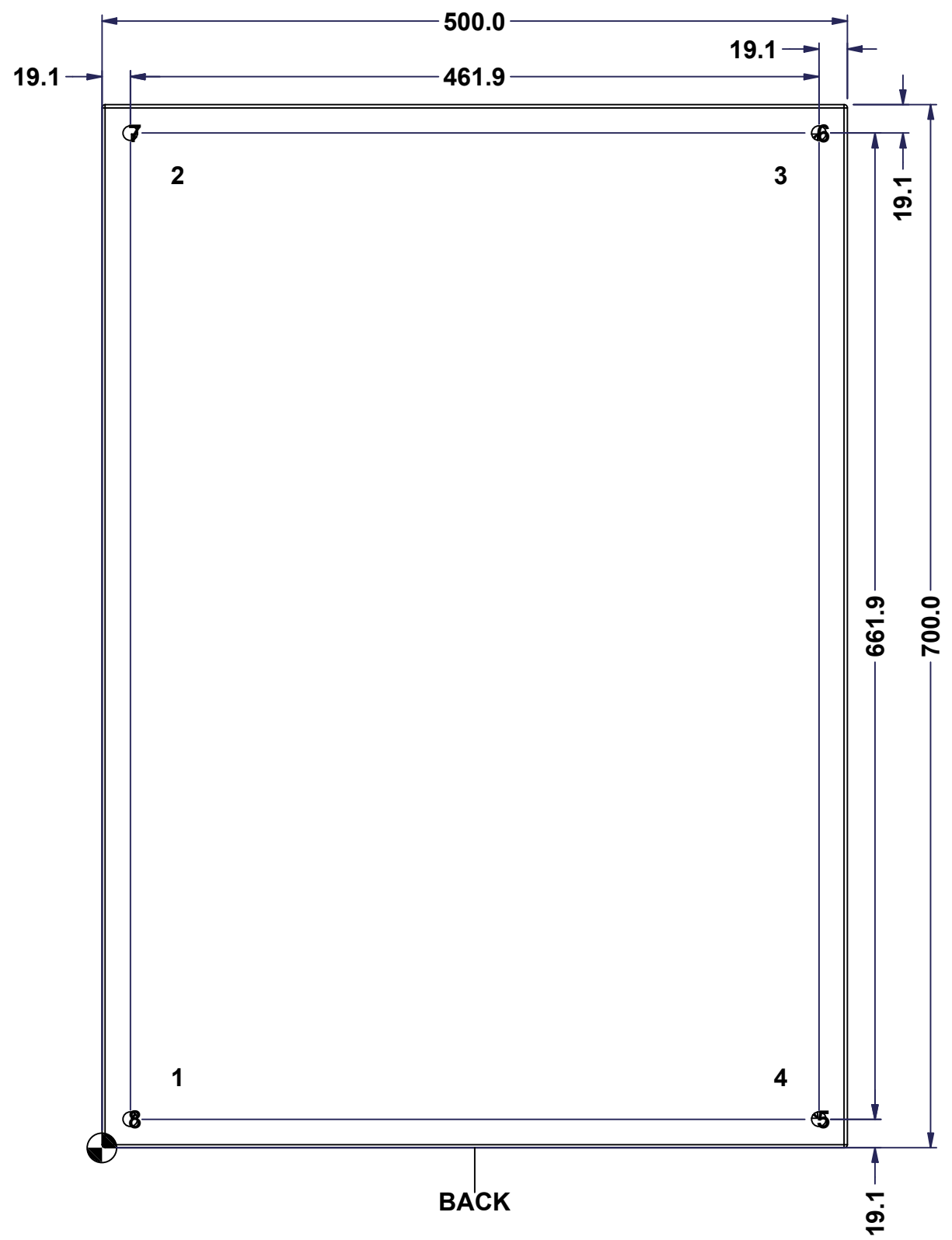

BACK

	Description	Status
	6412ESW 700mm x 500mm x 220mm Body	(NULL)
	Part Number	Rev.
	Numéro Pièce	5
	6412ESW050725B	0
		9

This drawing is confidential and must not be reproduced or used without the consent of EXM

Ce dessin est confidentiel et ne doit pas être reproduit ou utilisé sans le consentement de EXM

No.	Revisions	Date	By/Par

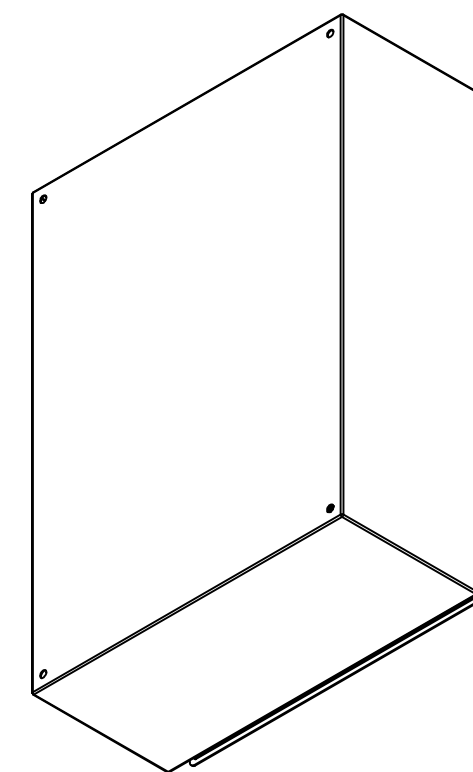

Isometric View

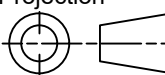

 Tél: (450) 979-4373 Fax: (450) 979-4626 www.exmweb.com		Flatness Aplatissement Max 3.0mm
Customer Client		Projection 
Drawn By Dessiné Par BoxCad: BoxCad		Date 14-Aug-14
Material Matière 16 Ga Cold Rolled A1008 CS Type B (1.4mm)		
Color Couleur Light Grey RAL7035	Finish Fini Textured	
Description 6412ESW 700mm x 500mm x 220mm Body		Detail Rev.
Part Number Numéro Pièce 6412ESW050725B		Rev. 6 0

Qty	Part Number	Rev	Description
1	STK-S-00100	0	3.5" x 2" Silver Milar Flexcon Sticker
1	STK-Q-16080	0	Ground Stud M6 x 16mm Steel
1	STK-P-03820R	0	Powder Paint (Light Grey / Rough Textured)
4	STK-Q-16005	0	Stud M8 x 35mm Steel
1	6412ESW050725B-P	0	6412ESW 700mm x 500mm x 220mm Body Part
Parts List			

This drawing is confidential and must not be reproduced or used without the consent of EXM

Ce dessin est confidentiel et ne doit pas être reproduit ou utilisé sans le consentement de EXM

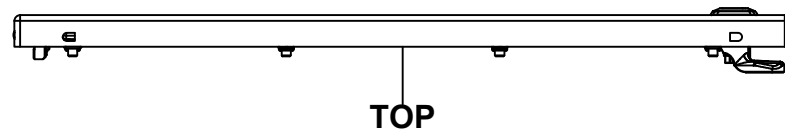

TOP

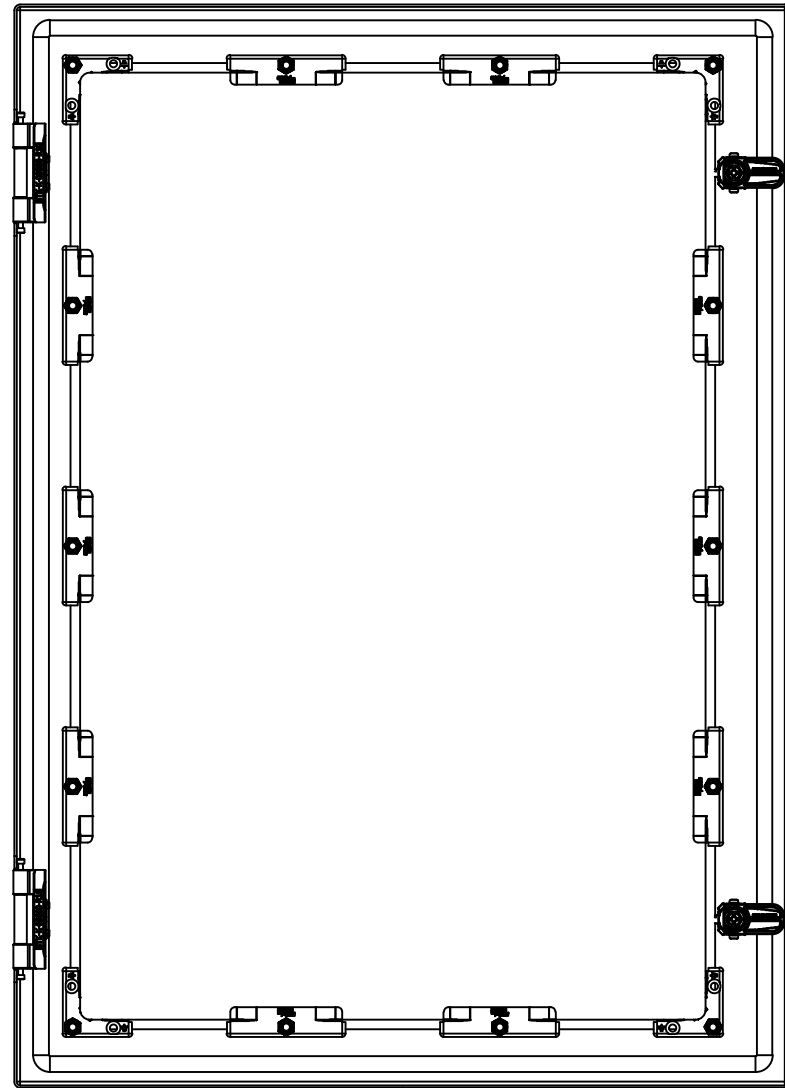

BACK

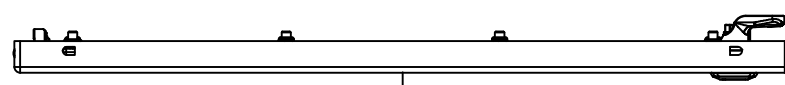

BOTTOM

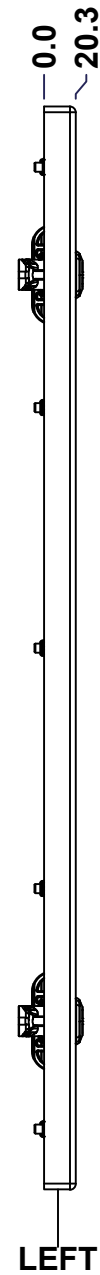

LEFT

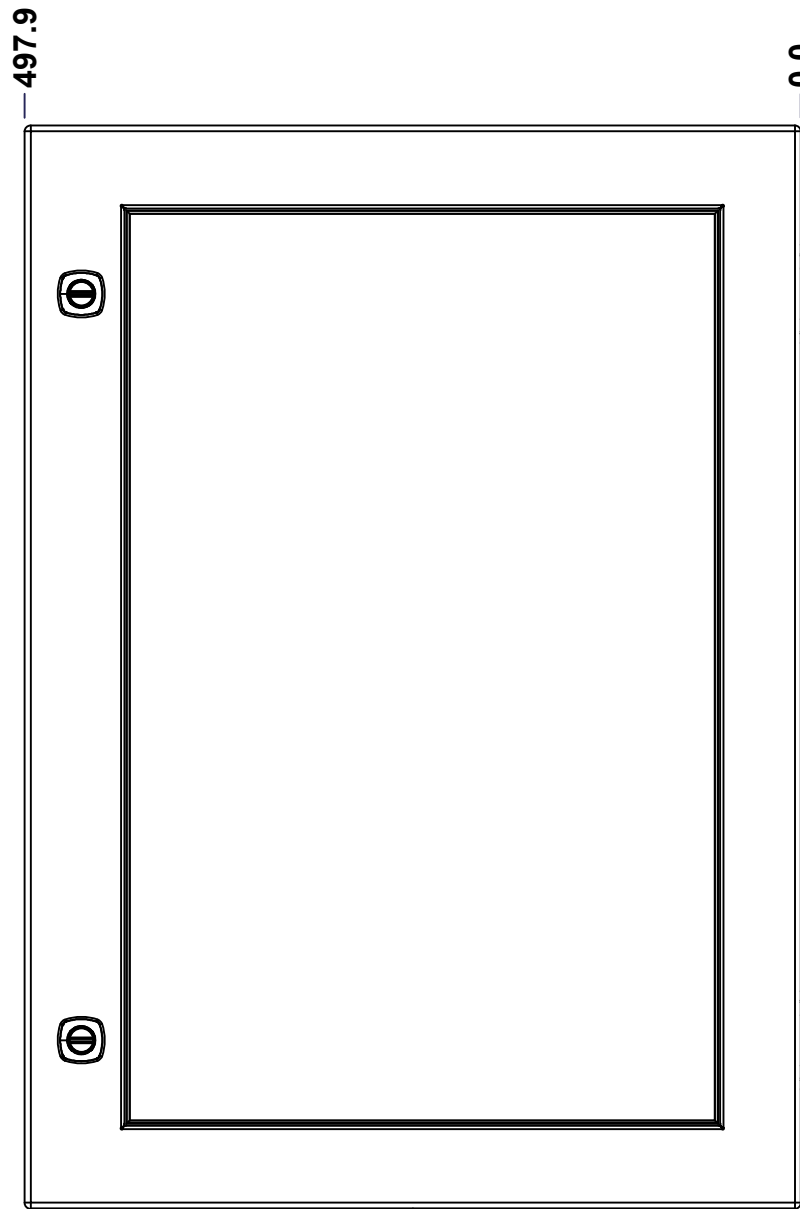

FRONT

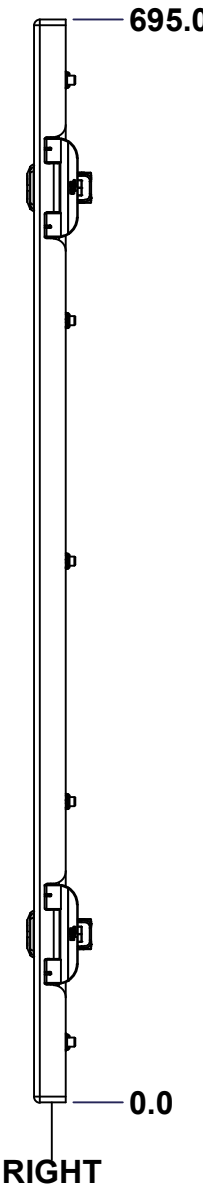

RIGHT

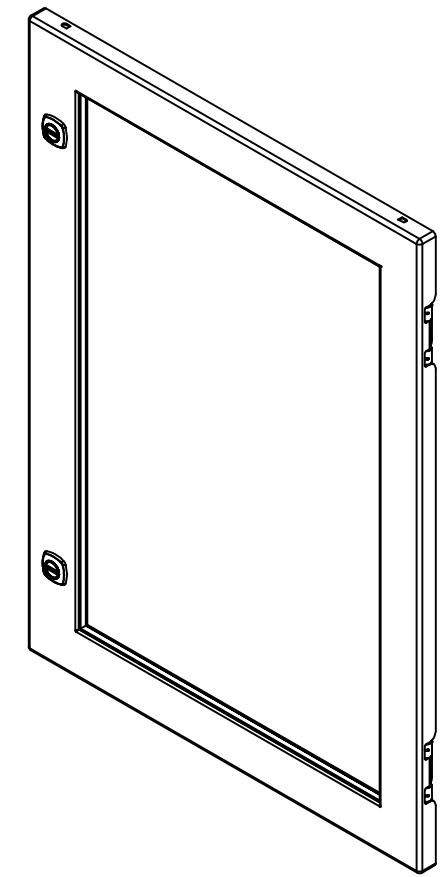

Isometric View

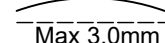
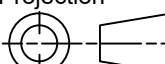

No.	Revisions	Date	By/Par

 Tél: (450) 979-4373 Fax: (450) 979-4626 www.exmweb.com		Flatness Aplatissement  Max 3.0mm Projection 
Customer Client	Date	
Drawn By Dessiné Par	BoxCad: BoxCad	Date 14-Aug-14
Material Matière	16 Ga Cold Rolled A1008 CS Type B (1.4mm)	
Color Couleur	Light Grey RAL7035	Finish Fini Textured
Description	Detail Rev.	
6412ESW 700mm x 500mm Cover		
Part Number Numéro Pièce	Rev.	7
6412ESW050725C		0

SEE BILL OF MATERIAL ON LAST PAGE

This drawing is confidential and must not be reproduced or used without the consent of EXM

Ce dessin est confidentiel et ne doit pas être reproduit ou utilisé sans le consentement de EXM

STANDARD FEATURES ARE NOT LISTED IN THIS HOLE TABLE			
HOLE TABLE - FRONT VIEW (CUSTOM FEATURE ONLY)			
CUT-OUT	XDIM	YDIM	DESCRIPTION
1	37.3	193.1	STUD M6 x 25mm (Inside)
2	448.4	193.1	STUD M6 x 25mm (Inside)
3	37.3	347.5	STUD M6 x 25mm (Inside)
4	448.4	347.5	STUD M6 x 25mm (Inside)
5	37.3	501.9	STUD M6 x 25mm (Inside)
6	448.4	501.9	STUD M6 x 25mm (Inside)
7	37.3	656.2	STUD M6 x 25mm (Inside)
8	37.3	38.8	STUD M6 x 25mm (Inside)
9	174.3	656.2	STUD M6 x 25mm (Inside)
10	174.3	38.8	STUD M6 x 25mm (Inside)
11	311.4	656.2	STUD M6 x 25mm (Inside)
12	311.4	38.8	STUD M6 x 25mm (Inside)
13	448.4	656.2	STUD M6 x 25mm (Inside)
14	448.4	38.8	STUD M6 x 25mm (Inside)

15	461.7	587.0	LOCK 880 SCQ4-SL @ 180.0°
16	461.7	108.0	LOCK 880 SCQ4-SL @ 180.0°

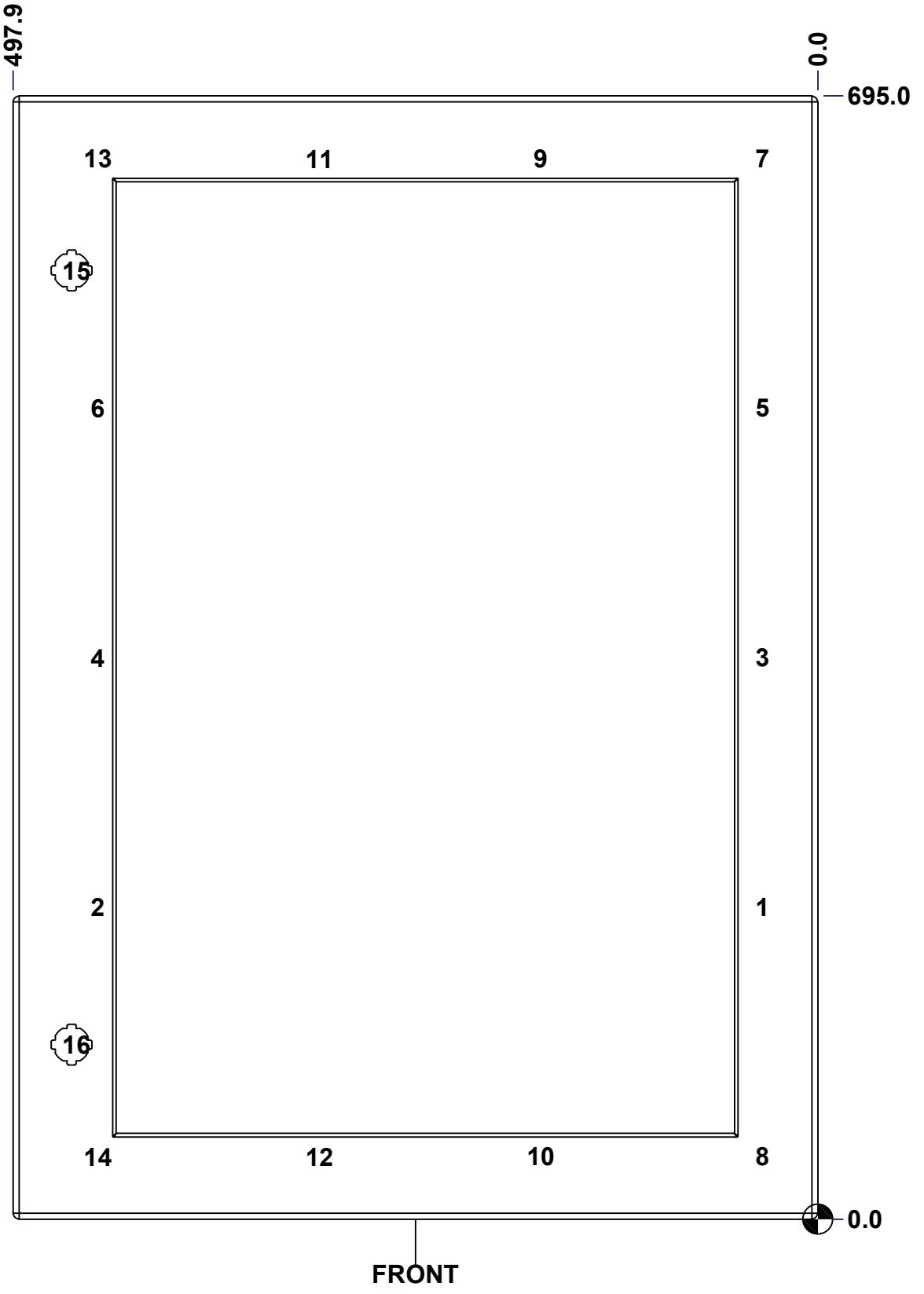

	Description		Status
	6412ESW 700mm x 500mm Cover		(NULL)
Part Number		Rev.	8
Numéro Pièce		0	9
		6412ESW050725C	

This drawing is confidential and must not be reproduced or used without the consent of EXM

Ce dessin est confidentiel et ne doit pas être reproduit ou utilisé sans le consentement de EXM

No.	Revisions	Date	By/Par

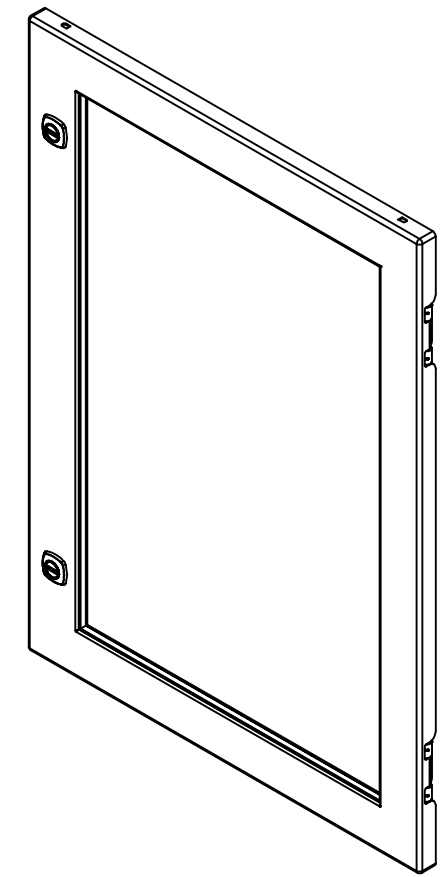

Isometric View

QTY	Part Number	Rev	Description
2	STK-K-12500	19	5412 ES 1/4 Turn Lock
1	STK-P-03820R	0	Powder Paint (Light Grey / Rough Textured)
1	STK-A-60703	0	5412 ESW Lexan Bracket Kit
14	STK-Q-16012	0	Stud M6 x 25mm Steel
1	STK-G-02710	0	880 HWKG - Windows Kit Gasket
1	6412ESW050725LXG	0	6412ESW 700mm x 500mm Lexan Gasket Part
1	6412ESW050725LX	0	6412ESW 607.9mm x 401.6mm Lexan Part
1	6412ESW050725G	0	6412ESW 700mm x 500mm Cover Gasket Part
1	6412ESW050725C-P	0	6412ESW 700mm x 500mm Cover Part
2	STK-K-09800		5412 ES Hinge with 2 Captive Hinge Pins
10	STK-Q-60701	2.1	880 WK - Lexan 1/4" Fixing Bracket

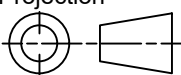
 Tél: (450) 979-4373 Fax: (450) 979-4626 www.exmweb.com		Flatness Aplatissement Max 3.0mm Projection 
Customer Client	Date	
Drawn By Dessiné Par	BoxCad: BoxCad	Date 14-Aug-14
Material Matière	16 Ga Cold Rolled A1008 CS Type B (1.4mm)	
Color Couleur	Light Grey RAL7035	Finish Fini Textured
Description	Detail Rev.	
6412ESW 700mm x 500mm Cover		
Part Number Numéro Pièce	Rev.	9
6412ESW050725C	0	9

Parts List

This drawing is confidential and must not be reproduced or used without the consent of EXM

Ce dessin est confidentiel et ne doit pas être reproduit ou utilisé sans le consentement de EXM

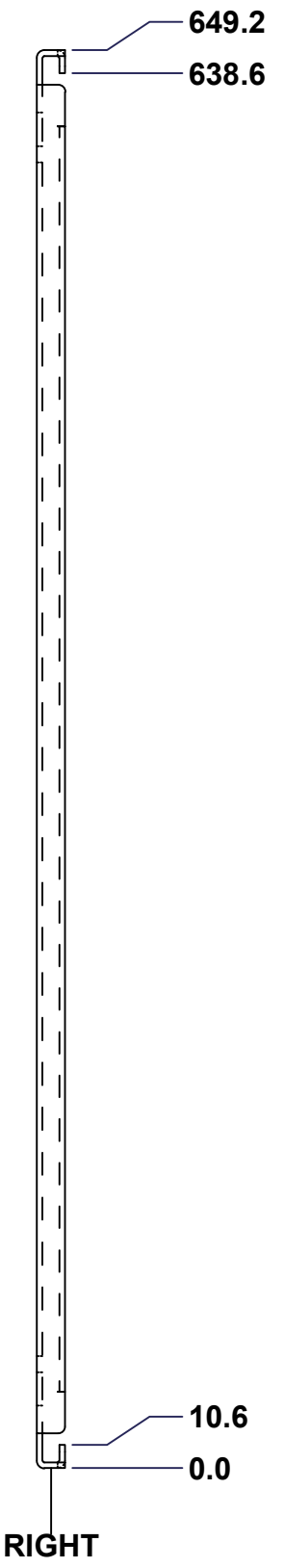
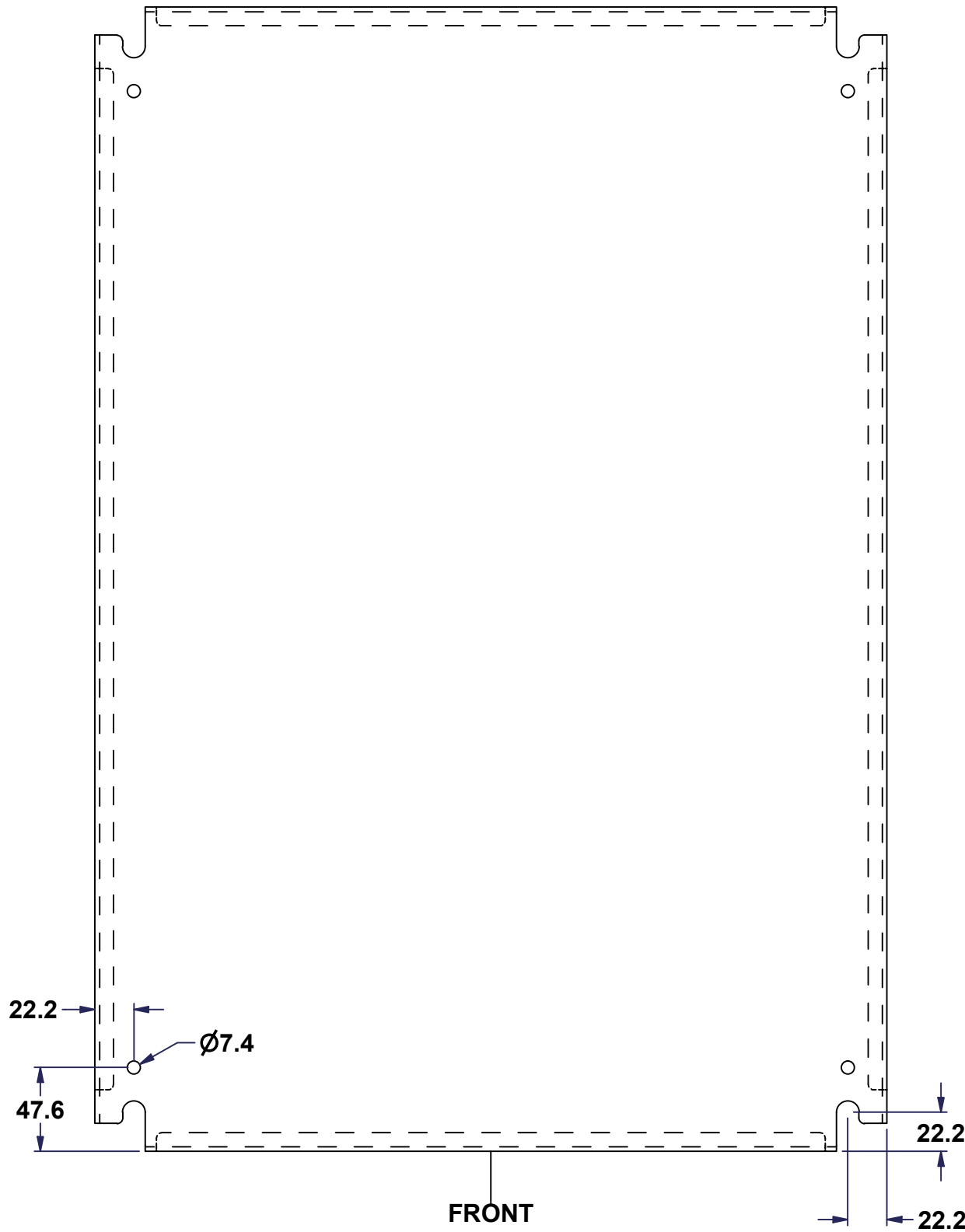
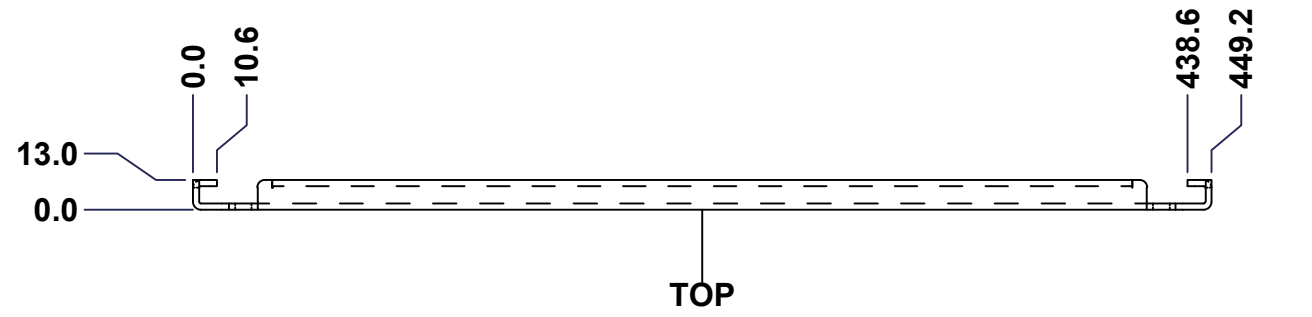

SEE BILL OF MATERIAL ON LAST PAGE

No.	Revisions	Date	By/Par

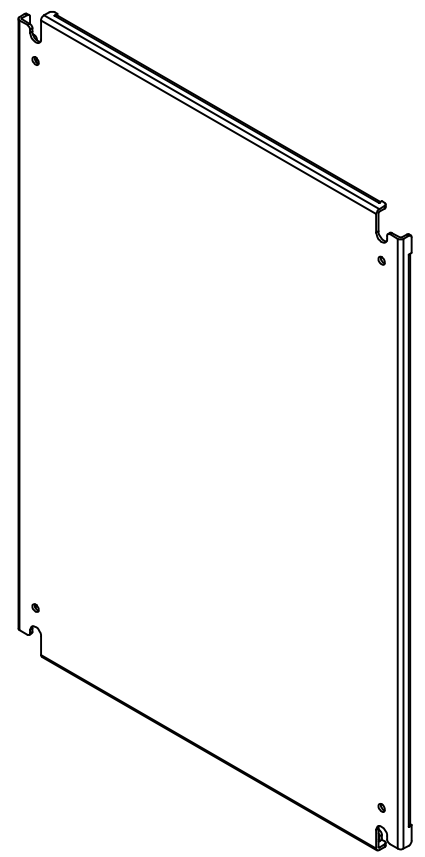

Isometric View



<p>Tél: (450) 979-4373 Fax: (450) 979-4626 www.exmweb.com</p>	Flatness Aplatissement	Max 3.0mm
	Projection	
Customer Client	Date	
Drawn By Dessiné Par	BoxCad	Date 23-Jan-07
Material Matière	12 Ga Galvanized (2.5mm)	
Color Couleur	Unpainted	Finish Fini Unpainted
Description	Detail Rev.	
886 SP - Inner Panel		
Part Number Numéro Pièce	Rev.	1
886 SP0507ES	0	2

This drawing is confidential and must not be reproduced or used without the consent of EXM

Ce dessin est confidentiel et ne doit pas être reproduit ou utilisé sans le consentement de EXM

No.	Revisions	Date	By/Par

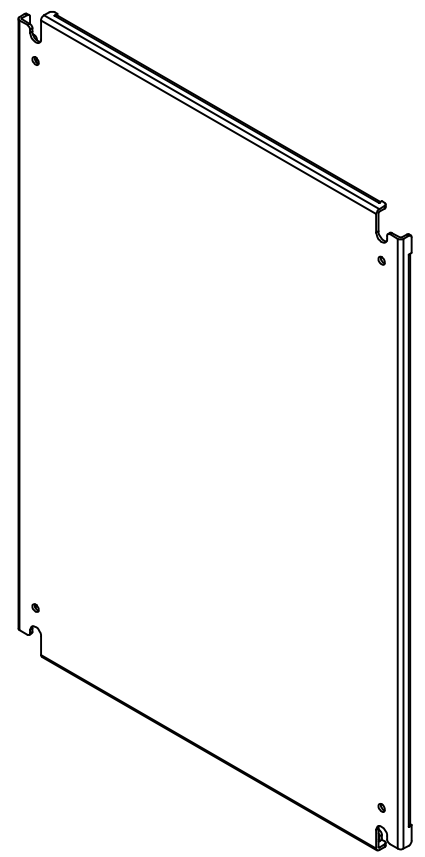

Isometric View



Tél: (450) 979-4373
 Fax: (450) 979-4626
 www.exmweb.com

Flatness
Aplatissement
Max 3.0mm
Projection

Customer Client	Date
Drawn By / Dessiné Par: BoxCad	Date: 23-Jan-07
Material / Matière: 12 Ga Galvanized (2.5mm)	
Color / Couleur: Unpainted	Finish / Fini: Unpainted

Description: 886 SP - Inner Panel	Detail Rev.
-----------------------------------	-------------

Qty	Part Number	Rev	Description
1	886 SP0507ES-P	0	886 SP - Inner Panel Part
Parts List			

Part Number / Numéro Pièce: 886 SP0507ES	Rev. 0	2
---	--------	---