

This drawing is confidential and must not be reproduced or used without the consent of EXM

Ce dessin est confidentiel et ne doit pas être reproduit ou utilisé sans le consentement de EXM

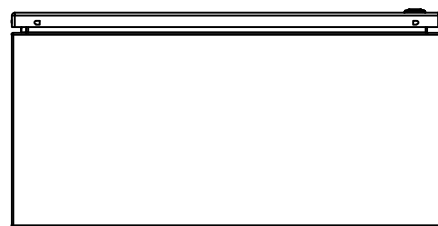

TOP



BACK

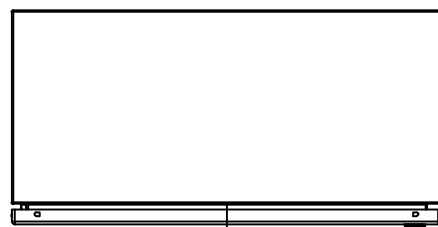

BOTTOM

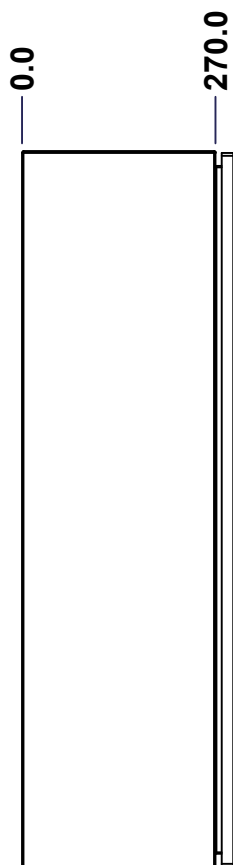

LEFT

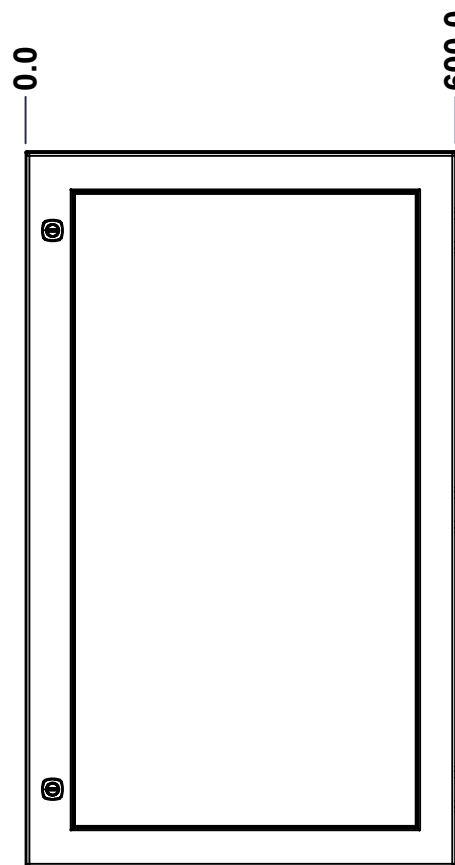

FRONT

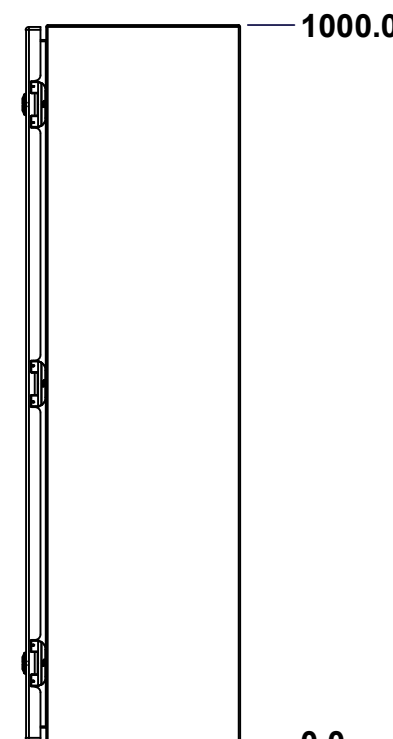

RIGHT

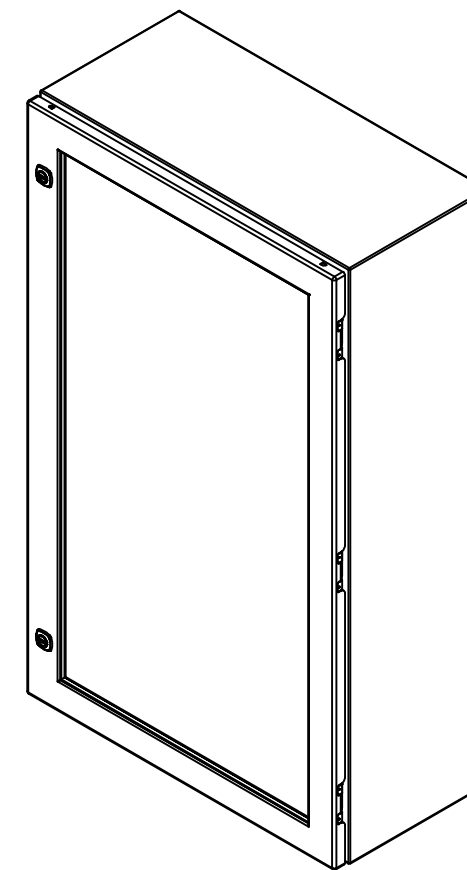

Isometric View



No.	Revisions	Date	By/Par

 Tél: (450) 979-4373
 Fax: (450) 979-4626
www.exmweb.com

Flatness / Aplatissement: Max 3.0mm
 Projection: 

Customer Client	Date
Drawn By / Dessiné Par: BoxCad: BoxCad	Date: 16-Sep-14

Material / Matière: 16 Ga Cold Rolled A1008 CS Type B (1.4mm)

Color / Couleur: Light Grey RAL7035	Finish / Fini: Textured
-------------------------------------	-------------------------

Description: 6412ESW 1000mm x 600mm x 270mm Assembly

Detail Rev.

Part Number / Numéro Pièce: 6412ESW061030	Rev. 0	1	9
---	--------	---	---

SEE BILL OF MATERIAL ON LAST PAGE

This drawing is confidential and must not be reproduced or used without the consent of EXM

Ce dessin est confidentiel et ne doit pas être reproduit ou utilisé sans le consentement de EXM

NOTE	
ITEM	DESCRIPTION
1	NEMA 4, 12 Enclosure (IP66)
2	C/W Standard ground studs on box and cover
3	W/O Standard door stiffener
4	C/W Standard inner panel (Included)
5	C/W Standard inner panel mounting studs

No.	Revisions	Date	By/Par

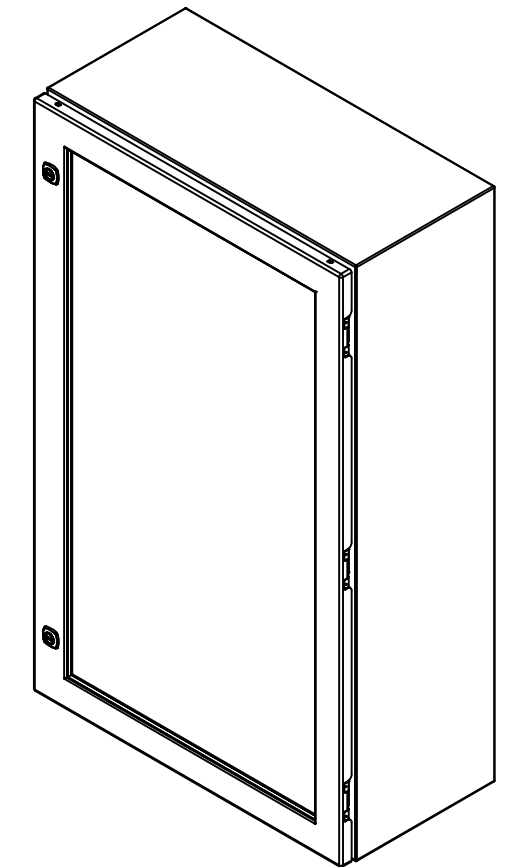

Isometric View

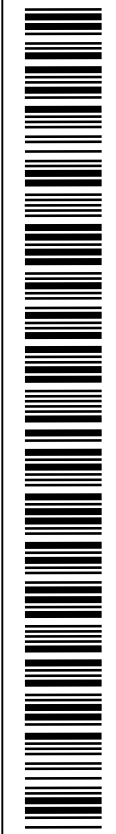

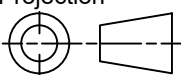
 Tél: (450) 979-4373 Fax: (450) 979-4626 www.exmweb.com	Flatness Aplatissement
	Max 3.0mm
	Projection
	
Customer Client	Date
Drawn By Dessiné Par	BoxCad: BoxCad
Material Matière	16 Ga Cold Rolled A1008 CS Type B (1.4mm)

PACKING		
ITEM	QTY	DESCRIPTION
Cardboard sleeve	2	Top and Bottom
Cardboard strip	2	Between back of enclosure and inner panel
Plastic bag	1	To protect cover surface and inside gasket
Plastic strap - Black	2	To Squeeze the 2 cardboard sleeve together
Packaging label	1	White label with product number

1	886 SP0610ES	0	886 SP - Inner Panel
3	STK-K-01320	0	5412 ES Inner Panel Accessory Kit
1	STK-K-01800	5	5412 ES Accessory Kit
1	6412ESW061030C	0	6412ESW 1000mm x 600mm Cover
1	6412ESW061030B	0	6412ESW 1000mm x 600mm x 270mm Body
3	STK-Q-04050-08	0	M6 x 8mm Hexagon Socket Head Machine Screw
Qty	Part Number	Rev	Description
Parts List			

Color Couleur	Light Grey RAL7035	Finish Fini	Textured
Description	6412ESW 1000mm x 600mm x 270mm Assembly		
Part Number Numéro Pièce	6412ESW061030		Detail Rev.
	Rev.	2	9
	0		

This drawing is confidential and must not be reproduced or used without the consent of EXM

Ce dessin est confidentiel et ne doit pas être reproduit ou utilisé sans le consentement de EXM

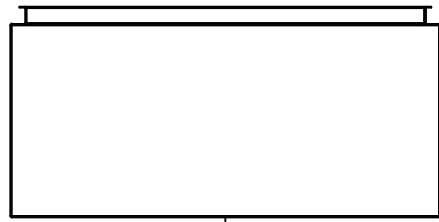

TOP

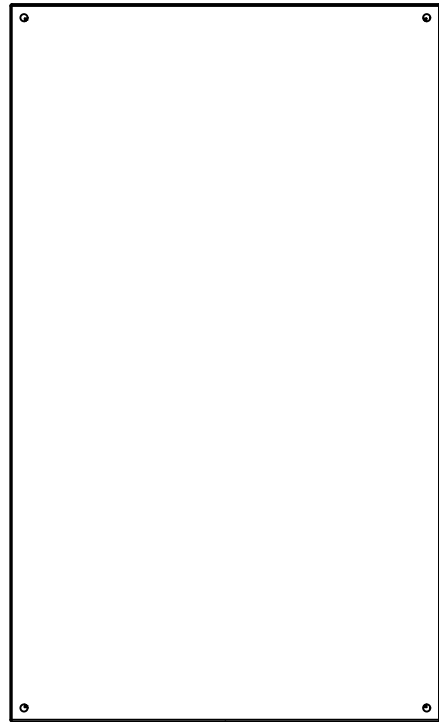

BACK

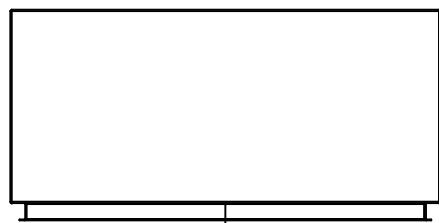

BOTTOM

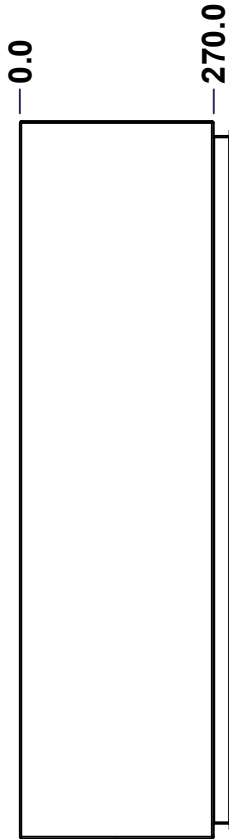

LEFT

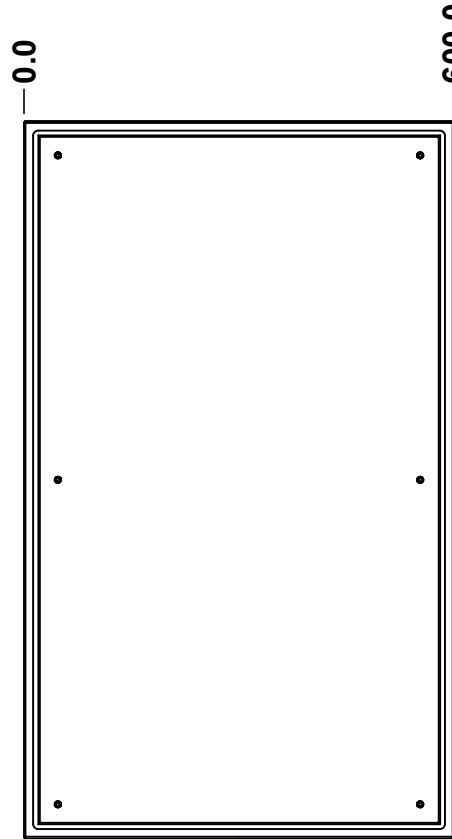

FRONT

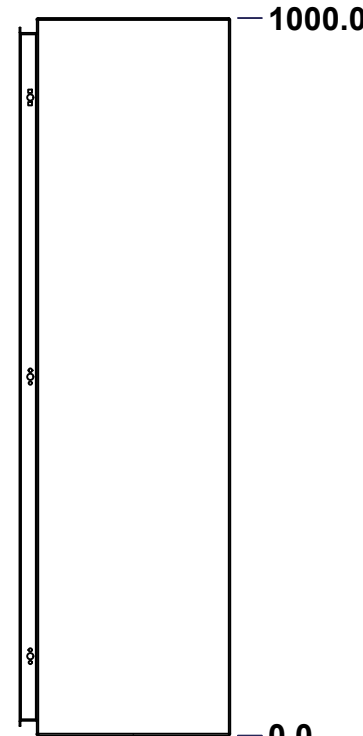

RIGHT

No.	Revisions	Date	By/Par

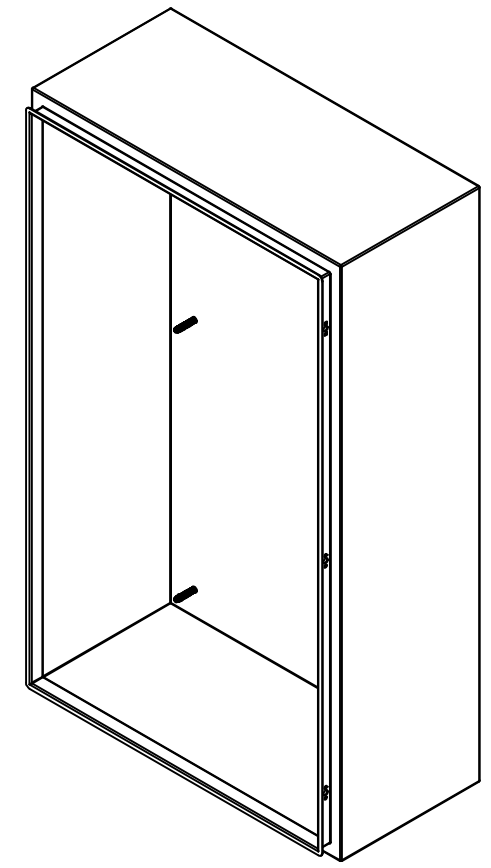

Isometric View



Tél: (450) 979-4373
 Fax: (450) 979-4626
www.exmweb.com

Flatness
Aplatissement

Max 3.0mm

Projection

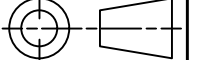

Customer Client	Date
Drawn By Dessiné Par BoxCad: BoxCad	Date 16-Sep-14
Material Matière 16 Ga Cold Rolled A1008 CS Type B (1.4mm)	
Color Couleur Light Grey RAL7035	Finish Fini Textured

Description 6412ESW 1000mm x 600mm x 270mm Body	Detail Rev.
---	-------------

Part Number Numéro Pièce	Rev.	3
6412ESW061030B	0	9

SEE BILL OF MATERIAL ON LAST PAGE

This drawing is confidential and must not be reproduced or used without the consent of EXM

Ce dessin est confidentiel et ne doit pas être reproduit ou utilisé sans le consentement de EXM

STANDARD FEATURES ARE NOT LISTED IN THIS HOLE TABLE			
HOLE TABLE - RIGHT VIEW (CUSTOM FEATURE ONLY)			
CUT-OUT	XDIM	YDIM	DESCRIPTION
1	231.9	50.8	GND STUD M6 x 16mm (Inside)
2	219.2	949.2	LABEL_EXM (Inside)

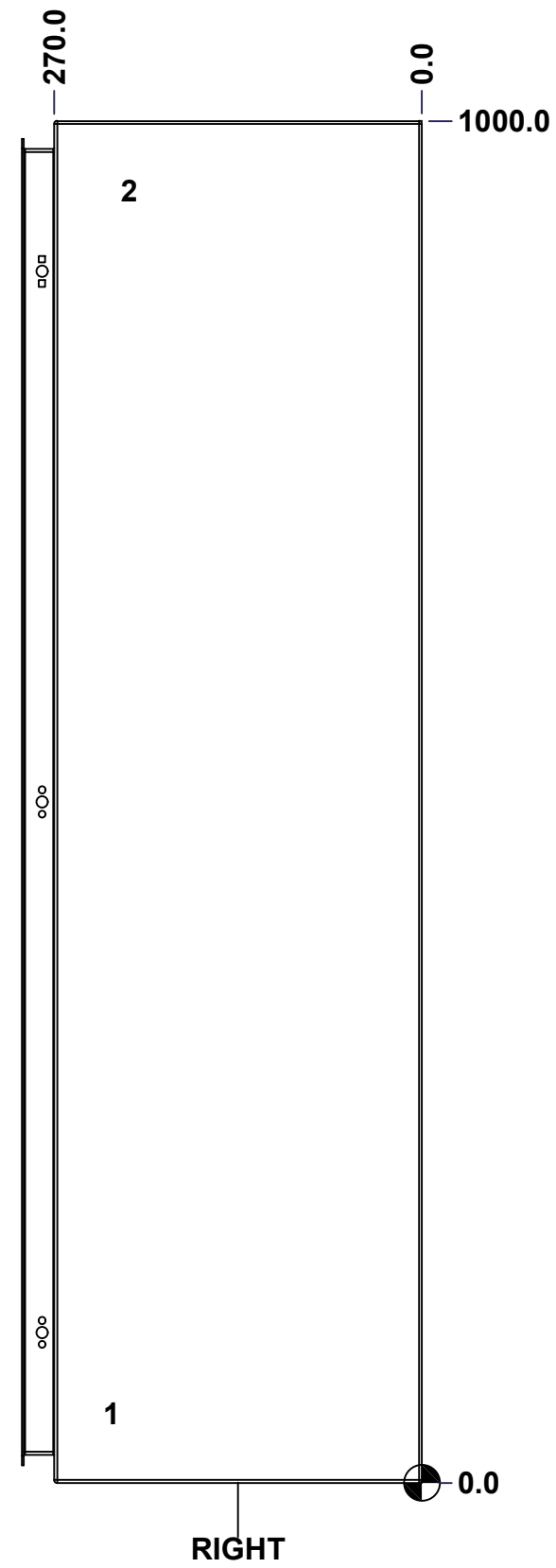

	Description 6412ESW 1000mm x 600mm x 270mm Body		Status (NULL)	
	Part Number Numéro Pièce 6412ESW061030B		Rev. 0	4 9

This drawing is confidential and must not be reproduced or used without the consent of EXM

Ce dessin est confidentiel et ne doit pas être reproduit ou utilisé sans le consentement de EXM

STANDARD FEATURES ARE NOT LISTED IN THIS HOLE TABLE

HOLE TABLE - BACK VIEW (CUSTOM FEATURE ONLY)

CUT-OUT	XDIM	YDIM	DESCRIPTION
1	47.6	47.6	IP STUD M8 x 35mm (Inside)
2	47.6	952.4	IP STUD M8 x 35mm (Inside)
3	552.4	952.4	IP STUD M8 x 35mm (Inside)
4	552.4	47.6	IP STUD M8 x 35mm (Inside)
5	47.6	500.0	IP STUD M8 x 35mm (Inside)
6	552.4	500.0	IP STUD M8 x 35mm (Inside)

7	581.0	19.1	RND Ø9.9
8	581.0	981.0	RND Ø9.9
9	19.1	981.0	RND Ø9.9
10	19.1	19.1	RND Ø9.9

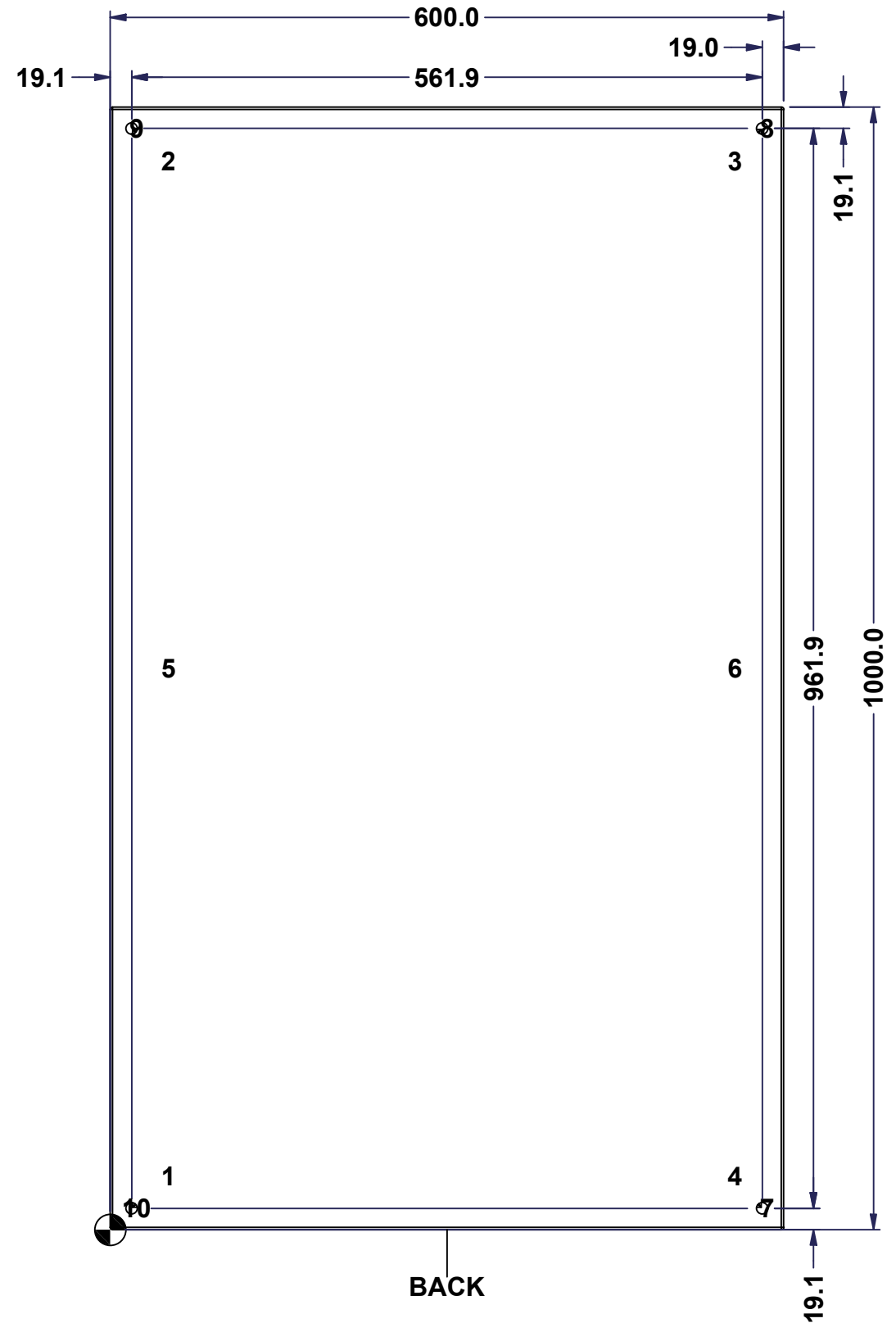

	Description 6412ESW 1000mm x 600mm x 270mm Body	Status (NULL)
	Part Number Numéro Pièce 6412ESW061030B	Rev. 5 0 / 9

This drawing is confidential and must not be reproduced or used without the consent of EXM

Ce dessin est confidentiel et ne doit pas être reproduit ou utilisé sans le consentement de EXM

No.	Revisions	Date	By/Par

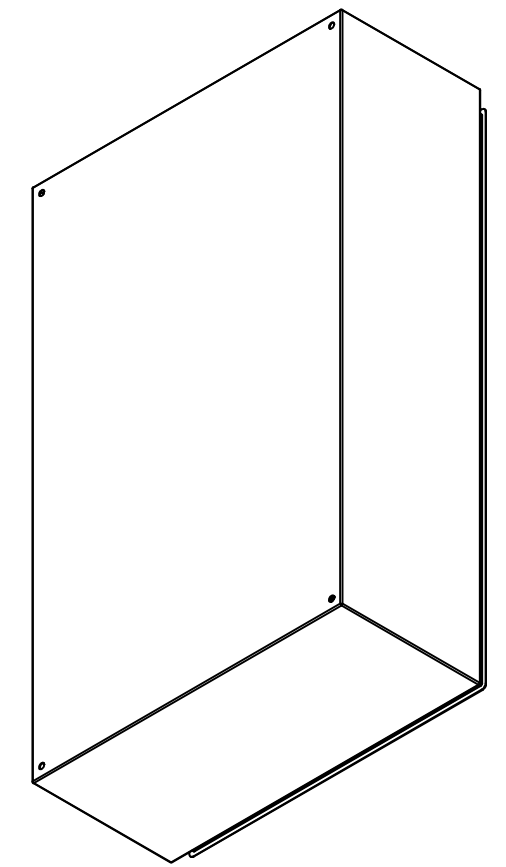

Isometric View

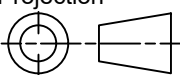

 Tél: (450) 979-4373 Fax: (450) 979-4626 www.exmweb.com		Flatness Aplatissement Max 3.0mm
Customer Client		Projection 
Drawn By / Dessiné Par: BoxCad: BoxCad		Date: 16-Sep-14
Material / Matière: 16 Ga Cold Rolled A1008 CS Type B (1.4mm)		
Color / Couleur: Light Grey RAL7035	Finish / Fini: Textured	
Description: 6412ESW 1000mm x 600mm x 270mm Body		Detail Rev.
Part Number / Numéro Pièce: 6412ESW061030B		Rev. 6 0 / 9

Qty	Part Number	Rev	Description
1	STK-S-00100	0	3.5" x 2" Silver Milar Flexcon Sticker
1	STK-Q-16080	0	Ground Stud M6 x 16mm Steel
1	STK-P-03820R	0	Powder Paint (Light Grey / Rough Textured)
6	STK-Q-16005	0	Stud M8 x 35mm Steel
1	6412ESW061030B-P	0	6412ESW 1000mm x 600mm x 270mm Body Part
Parts List			

This drawing is confidential and must not be reproduced or used without the consent of EXM

Ce dessin est confidentiel et ne doit pas être reproduit ou utilisé sans le consentement de EXM

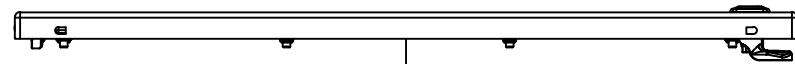

TOP

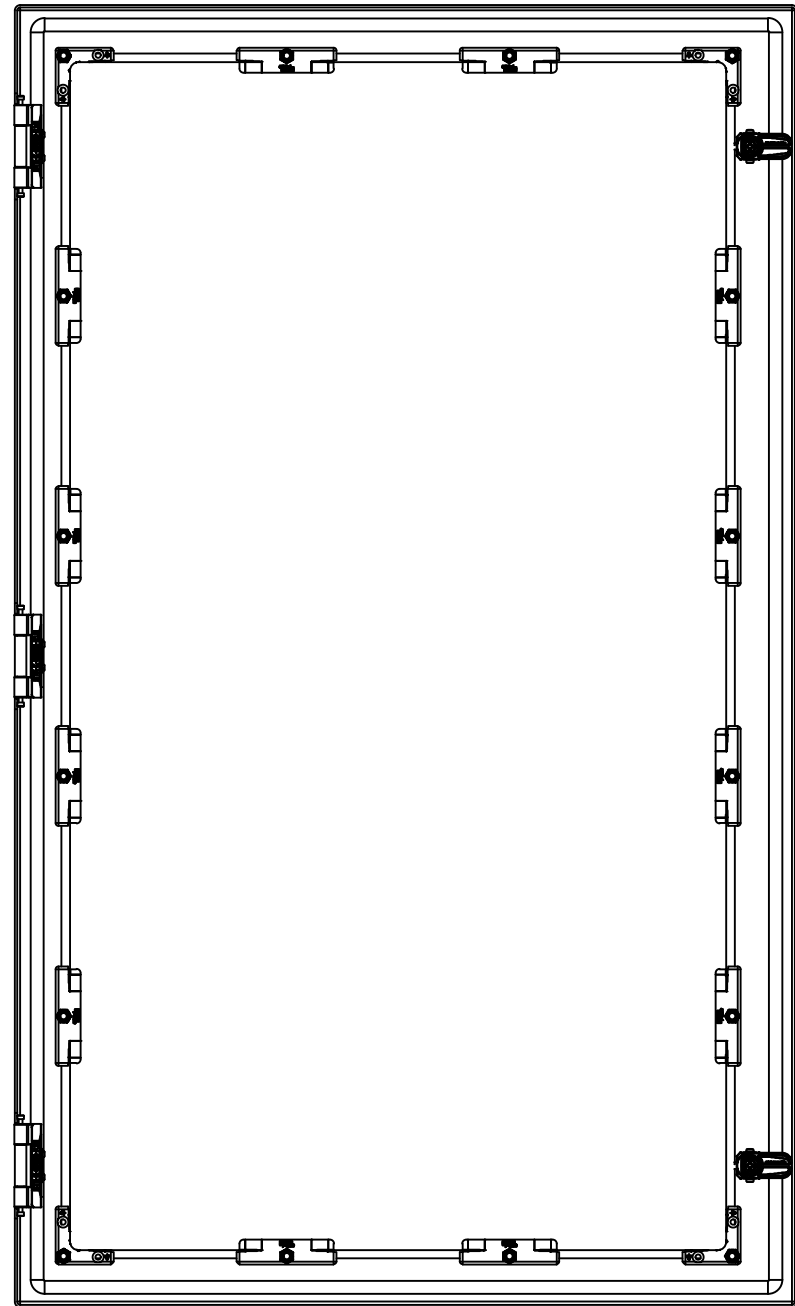

BACK

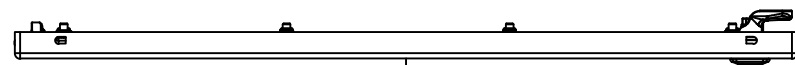

BOTTOM

0.0
20.3



LEFT

597.9

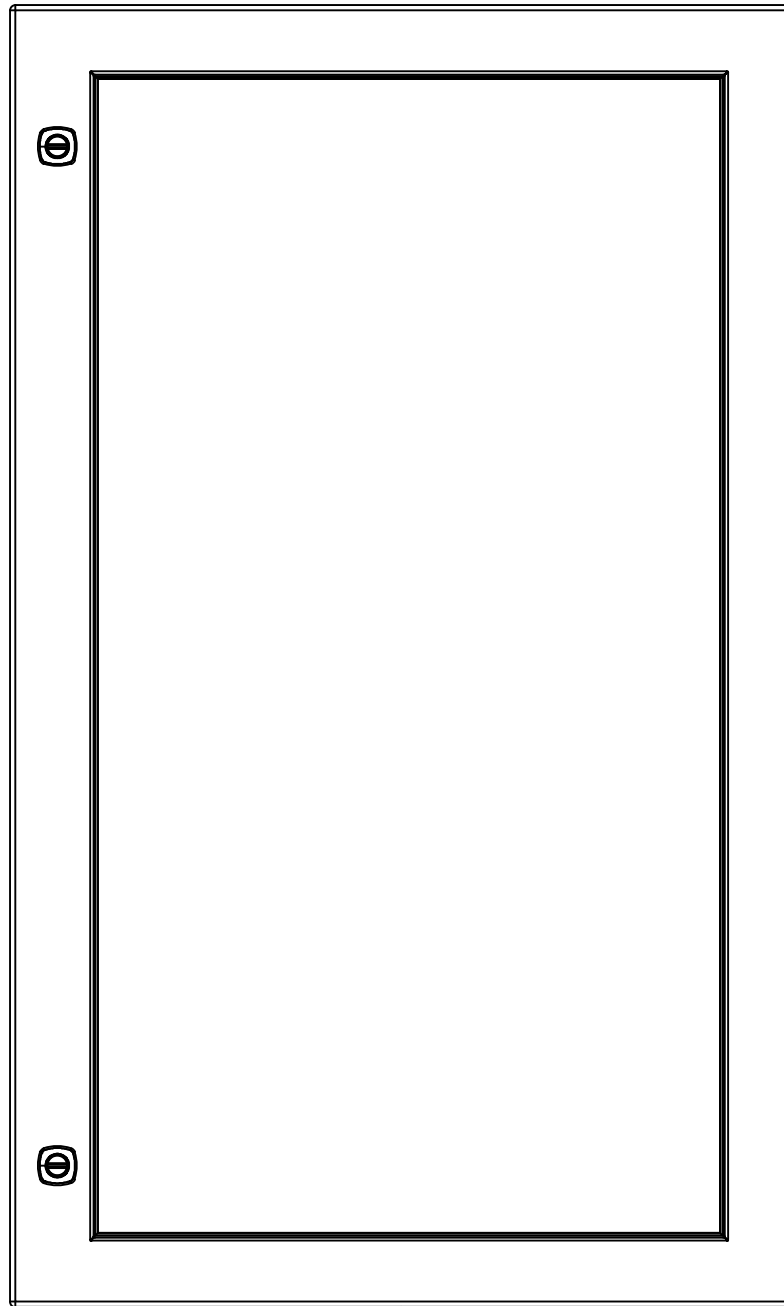

FRONT

0.0

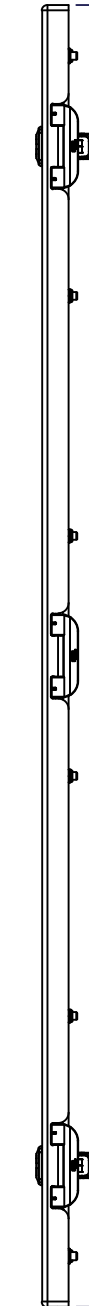



RIGHT

995.0

0.0

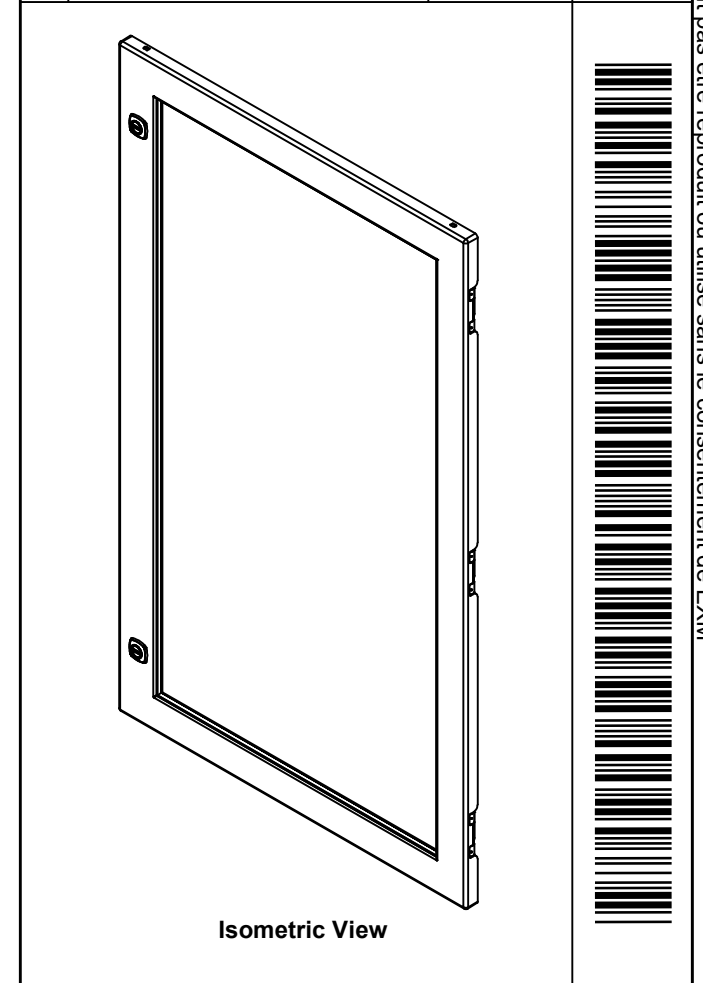
No.	Revisions	Date	By/Par



 Tél: (450) 979-4373 Fax: (450) 979-4626 www.exmweb.com		Flatness Aplatissement
		Max 3.0mm
Customer Client		Date
Drawn By Dessiné Par BoxCad: BoxCad		Date 16-Sep-14
Material Matière 14 Ga Cold Rolled A1008 CS Type B (1.7mm)		
Color Couleur Light Grey RAL7035	Finish Fini Textured	
Description 6412ESW 1000mm x 600mm Cover		Detail Rev.
Part Number Numéro Pièce 6412ESW061030C		Rev. 7
SEE BILL OF MATERIAL ON LAST PAGE		9

This drawing is confidential and must not be reproduced or used without the consent of EXM

Ce dessin est confidentiel et ne doit pas être reproduit ou utilisé sans le consentement de EXM

STANDARD FEATURES ARE NOT LISTED IN THIS HOLE TABLE			
HOLE TABLE - FRONT VIEW (CUSTOM FEATURE ONLY)			
CUT-OUT	XDIM	YDIM	DESCRIPTION
1	37.3	222.3	STUD M6 x 25mm (Inside)
2	548.4	222.3	STUD M6 x 25mm (Inside)
3	37.3	405.8	STUD M6 x 25mm (Inside)
4	548.4	405.8	STUD M6 x 25mm (Inside)
5	37.3	589.2	STUD M6 x 25mm (Inside)
6	548.4	589.2	STUD M6 x 25mm (Inside)
7	37.3	772.7	STUD M6 x 25mm (Inside)
8	548.4	772.7	STUD M6 x 25mm (Inside)
9	37.3	956.2	STUD M6 x 25mm (Inside)
10	37.3	38.8	STUD M6 x 25mm (Inside)
11	207.7	956.2	STUD M6 x 25mm (Inside)
12	207.7	38.8	STUD M6 x 25mm (Inside)
13	378.0	956.2	STUD M6 x 25mm (Inside)
14	378.0	38.8	STUD M6 x 25mm (Inside)
15	548.4	956.2	STUD M6 x 25mm (Inside)
16	548.4	38.8	STUD M6 x 25mm (Inside)

17	561.7	887.0	LOCK 880 SCQ4-SL @ 180.0°
18	561.7	108.0	LOCK 880 SCQ4-SL @ 180.0°

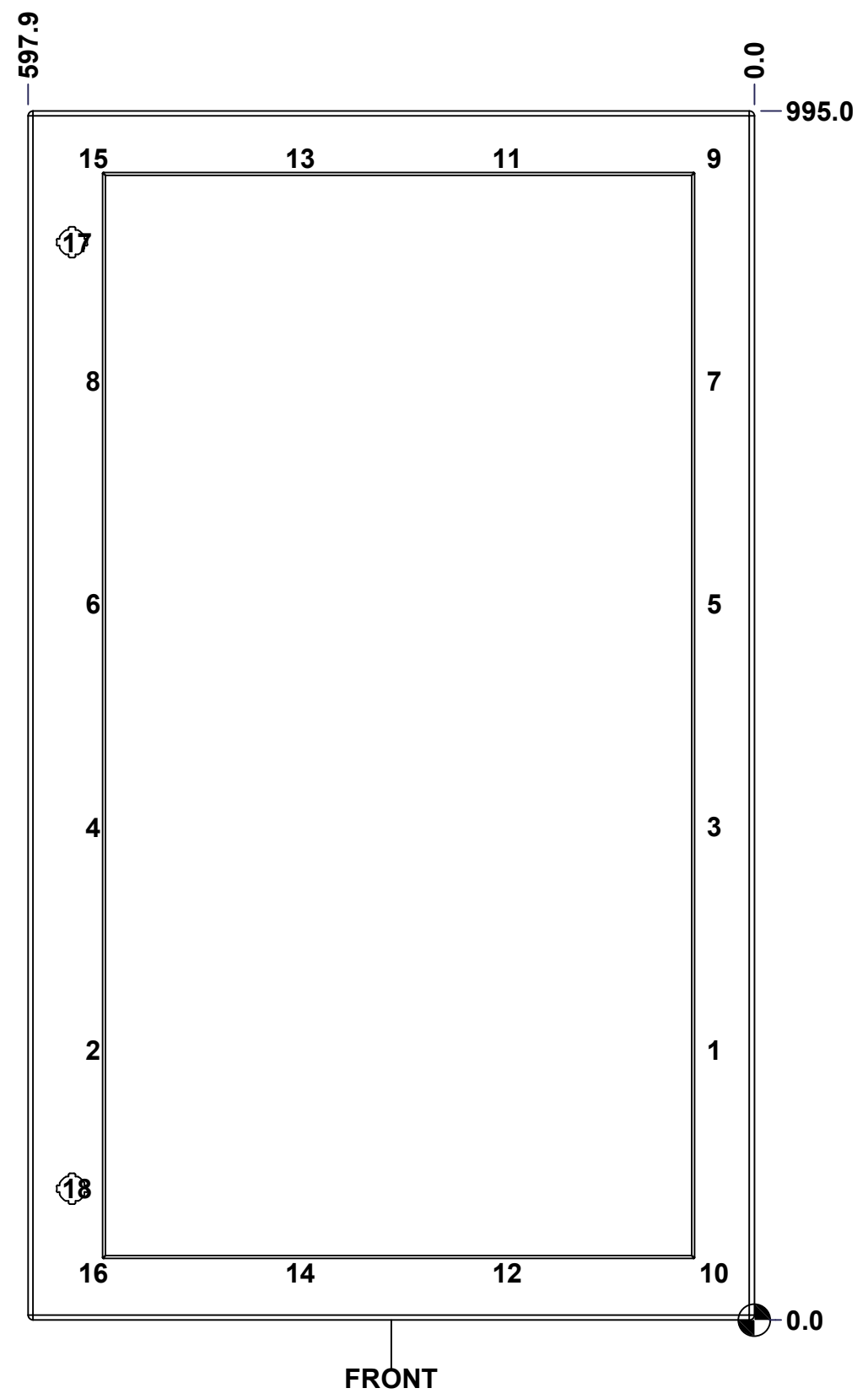

FRONT

	Description	Status
	6412ESW 1000mm x 600mm Cover	(NULL)
	Part Number	Rev.
	Numéro Pièce	8
	6412ESW061030C	0
		9

This drawing is confidential and must not be reproduced or used without the consent of EXM

Ce dessin est confidentiel et ne doit pas être reproduit ou utilisé sans le consentement de EXM

No.	Revisions	Date	By/Par

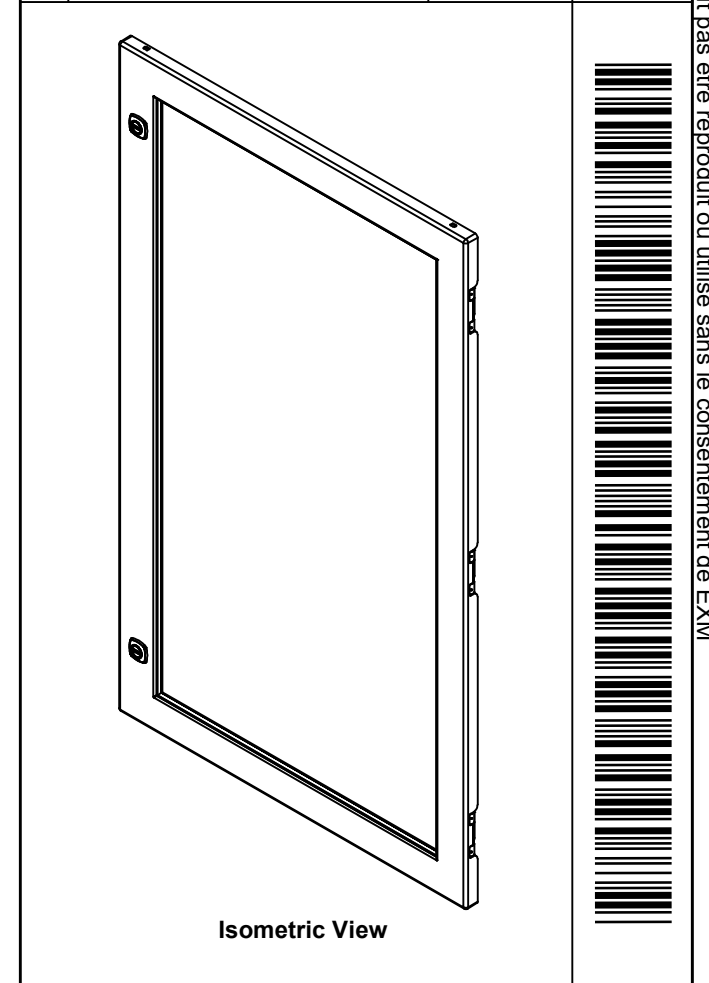

EXM
www.exmweb.com

Tél: (450) 979-4373
Fax: (450) 979-4626

Flatness
Aplatissement
Max 3.0mm

Projection

2	STK-K-12500	19	5412 ES 1/4 Turn Lock
1	STK-P-03820R	0	Powder Paint (Light Grey / Rough Textured)
1	STK-A-60703	0	5412 ESW Lexan Bracket Kit
16	STK-Q-16012	0	Stud M6 x 25mm Steel
1	STK-G-02710	0	880 HWKG - Windows Kit Gasket
1	6412ESW061030LXG	0	6412ESW 1000mm x 600mm Lexan Gasket Part
1	6412ESW061030LX	0	6412ESW 907.9mm x 501.6mm Lexan Part
1	6412ESW061030G	0	6412ESW 1000mm x 600mm Cover Gasket Part
1	6412ESW061030C-P	0	6412ESW 1000mm x 600mm Cover Part
3	STK-K-09800		5412 ES Hinge with 2 Captive Hinge Pins
12	STK-Q-60701	2.1	880 WK - Lexan 1/4" Fixing Bracket
QTY	Part Number	Rev	Description
Parts List			

Customer Client

Drawn By / Dessiné Par: BoxCad: BoxCad

Material / Matière: 14 Ga Cold Rolled A1008 CS Type B (1.7mm)

Color / Couleur: Light Grey RAL7035

Finish / Fini: Textured

Description: 6412ESW 1000mm x 600mm Cover

Part Number / Numéro Pièce: **6412ESW061030C**

Date: 16-Sep-14

Detail Rev.:

Rev.	9
0	9

This drawing is confidential and must not be reproduced or used without the consent of EXM

Ce dessin est confidentiel et ne doit pas être reproduit ou utilisé sans le consentement de EXM

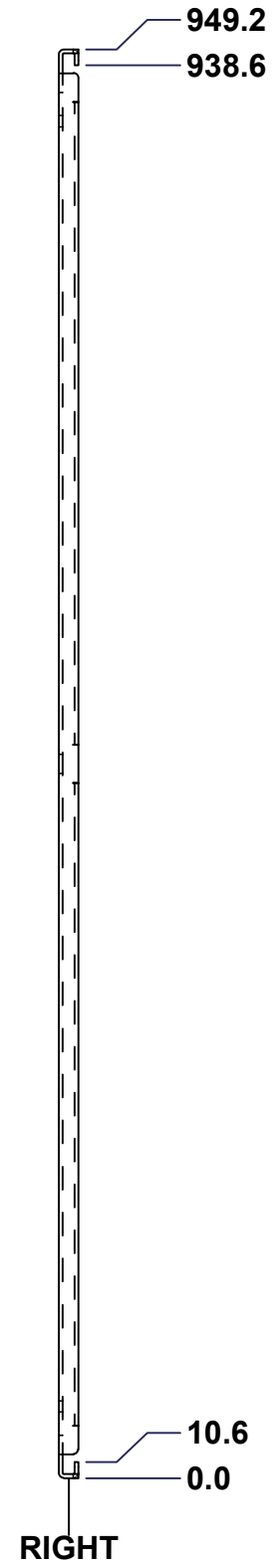
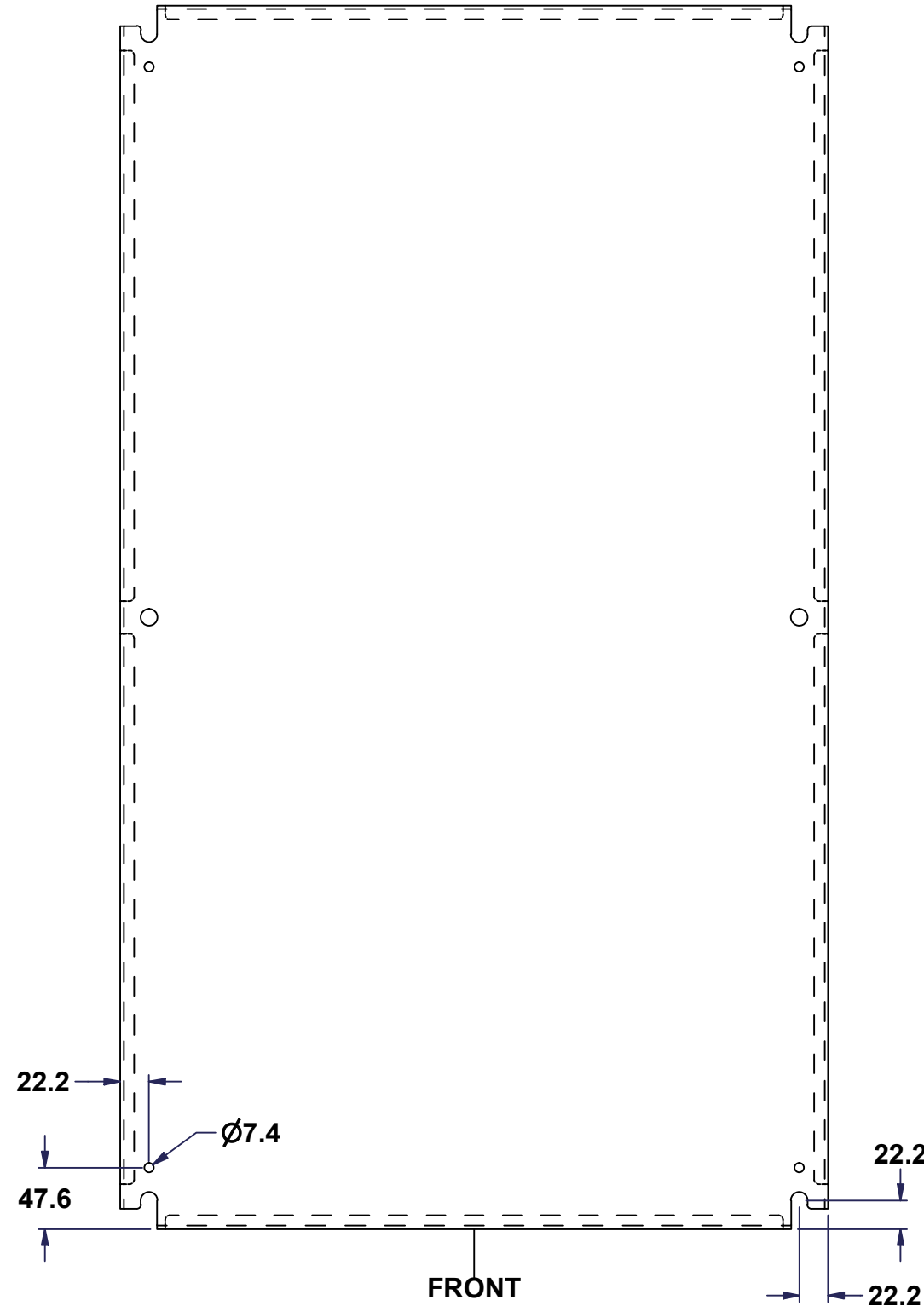
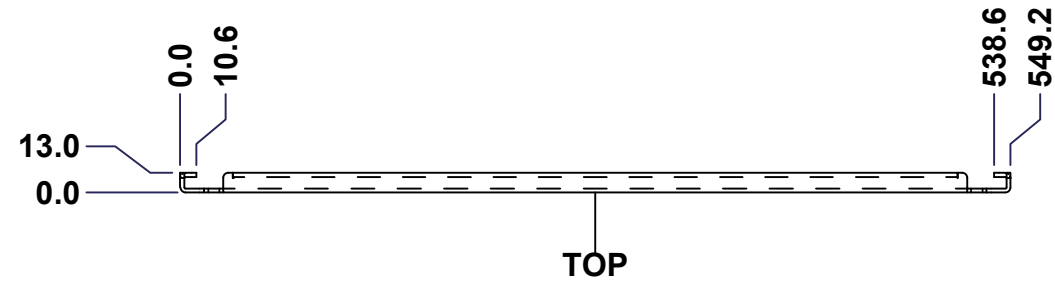

No.	Revisions	Date	By/Par

Isometric View

Tél: (450) 979-4373 Fax: (450) 979-4626 www.exmweb.com		Flatness Aplatissement Max 3.0mm
Projection 		Customer Client Date
Drawn By Dessiné Par BoxCad		Date 23-Jan-07
Material Matière 12 Ga Galvanized (2.5mm)		
Color Couleur Unpainted	Finish Fini Unpainted	
Description 886 SP - Inner Panel		Detail Rev.
Part Number Numéro Pièce 886 SP0610ES		Rev. 1 0

SEE BILL OF MATERIAL ON LAST PAGE

This drawing is confidential and must not be reproduced or used without the consent of EXM

Ce dessin est confidentiel et ne doit pas être reproduit ou utilisé sans le consentement de EXM

No.	Revisions	Date	By/Par

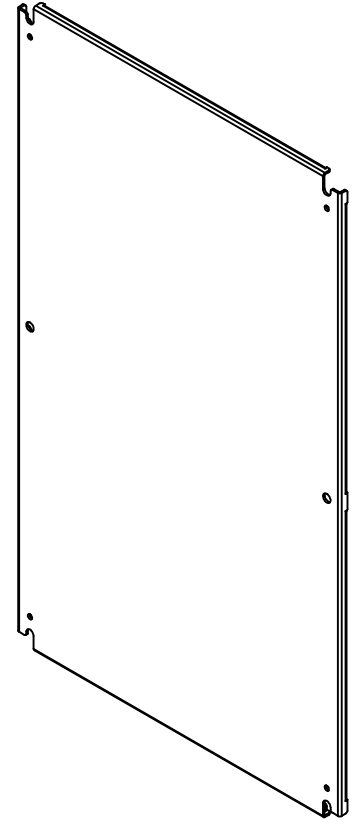

Isometric View



 Tél: (450) 979-4373 Fax: (450) 979-4626 www.exmweb.com		Flatness Aplatissement Max 3.0mm
Customer Client		Date
Drawn By / Dessiné Par: BoxCad		Date: 23-Jan-07
Material / Matière: 12 Ga Galvanized (2.5mm)		
Color / Couleur: Unpainted	Finish / Fini: Unpainted	
Description: 886 SP - Inner Panel		Detail Rev.
Part Number / Numéro Pièce: 886 SP0610ES		Rev. 0 / 2

Qty	Part Number	Rev	Description
1	886 SP0610ES-P	0	886 SP - Inner Panel Part
Parts List			