

This drawing is confidential and must not be reproduced or used without the consent of EXM

Ce dessin est confidentiel et ne doit pas être reproduit ou utilisé sans le consentement de EXM

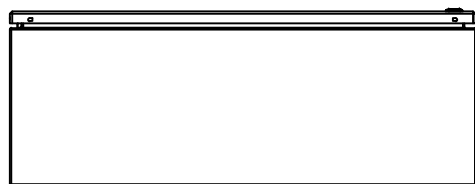

TOP

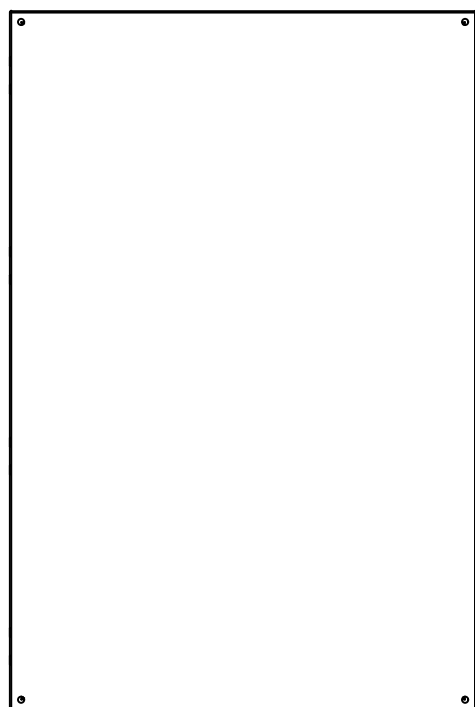

BACK

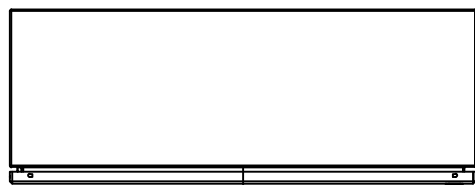

BOTTOM

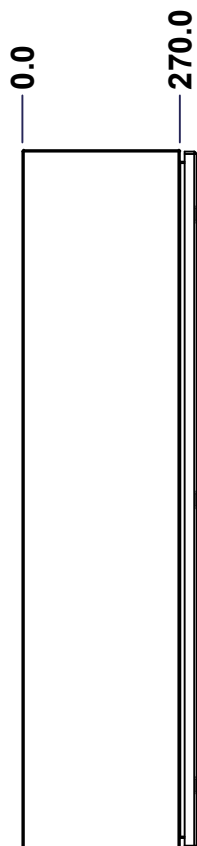

LEFT

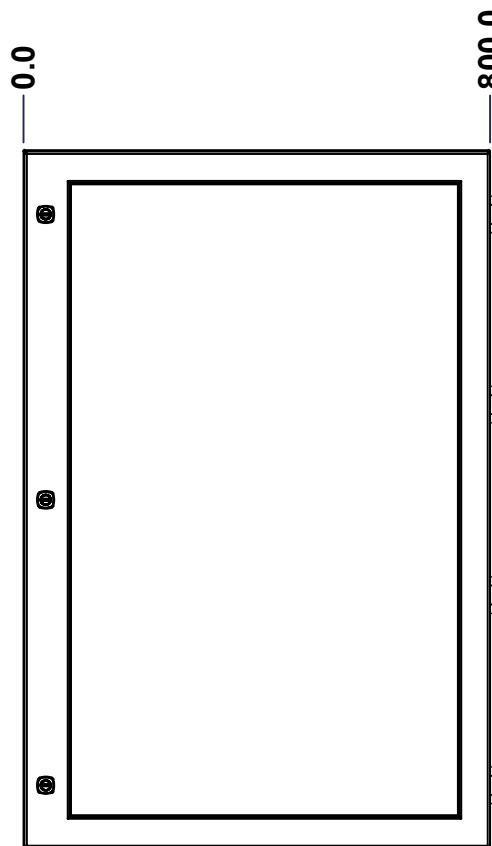

FRONT

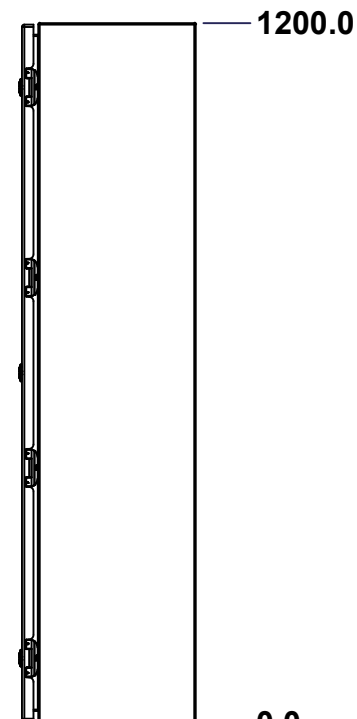

RIGHT

No.	Revisions	Date	By/Par

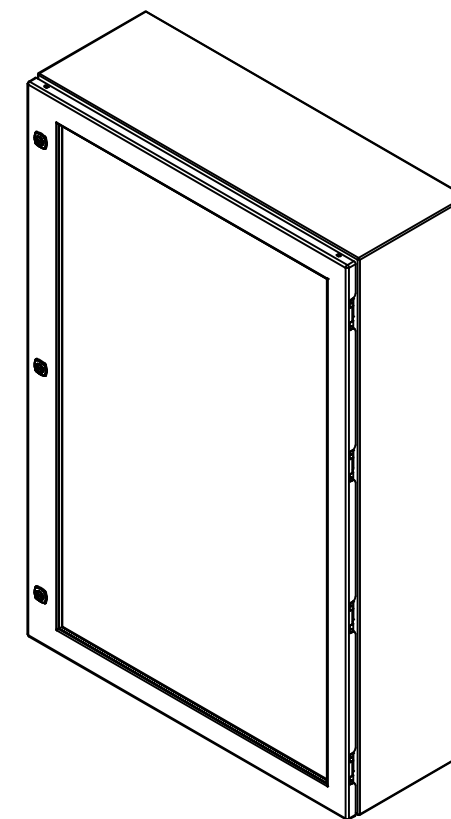

Isometric View



Tél: (450) 979-4373
 Fax: (450) 979-4626
www.exmweb.com

Flatness
Aplatissement

Max 3.0mm

Projection



Customer Client	Date
Drawn By Dessiné Par BoxCad: BoxCad	Date 15-Aug-14
Material Matière 14 Ga Cold Rolled A1008 CS Type B (1.7mm)	
Color Couleur Light Grey RAL7035	Finish Fini Textured
Description 6412ESW 1200mm x 800mm x 270mm Assembly	Detail Rev.
Part Number Numéro Pièce 6412ESW081230	Rev. 0

SEE BILL OF MATERIAL ON LAST PAGE

1
9

This drawing is confidential and must not be reproduced or used without the consent of EXM

Ce dessin est confidentiel et ne doit pas être reproduit ou utilisé sans le consentement de EXM

NOTE	
ITEM	DESCRIPTION
1	NEMA 4, 12 Enclosure (IP66)
2	C/W Standard ground studs on box and cover
3	W/O Standard door stiffener
4	C/W Standard inner panel (Included)
5	C/W Standard inner panel mounting studs

No.	Revisions	Date	By/Par

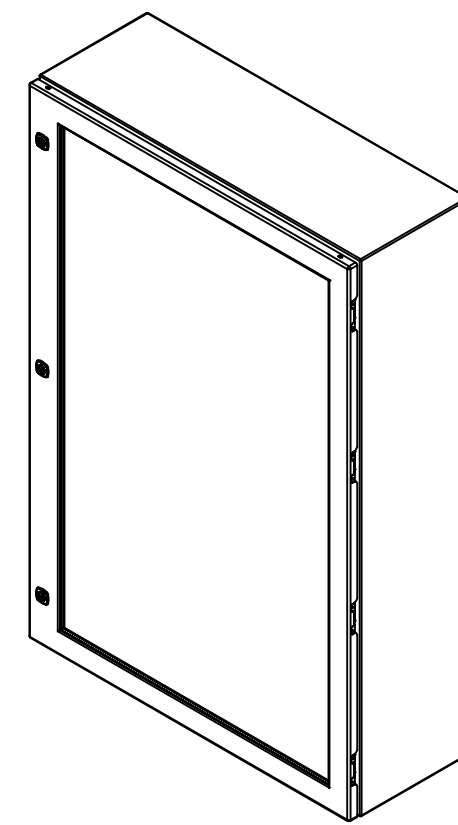

Isometric View



PACKING		
ITEM	QTY	DESCRIPTION
Cardboard sleeve	2	Top and Bottom
Cardboard strip	2	Between back of enclosure and inner panel
Plastic bag	1	To protect cover surface and inside gasket
Cardboard corner	4	To reinforced for the plastic strap tightening
Plastic strap - Black	2	To Squeeze the 2 cardboard sleeve together
Packaging label	3	White label with PN
Plastic strap- Green	2	To secure the enclosure to the wood pallet
Wood Pallet	1	2" deeper and 3" larger than enclosure size

1	886 SP0812ES	0	886 SP - Inner Panel
3	STK-K-01320	0	5412 ES Inner Panel Accessory Kit
1	STK-K-01800	5	5412 ES Accessory Kit
1	6412ESW081230C	0	6412ESW 1200mm x 800mm Cover
1	6412ESW081230B	0	6412ESW 1200mm x 800mm x 270mm Body
4	STK-Q-04050-08	0	M6 x 8mm Hexagon Socket Head Machine Screw
Qty	Part Number	Rev	Description
Parts List			

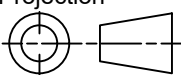
 Tél: (450) 979-4373 Fax: (450) 979-4626 www.exmweb.com	Flatness Aplatissement	Max 3.0mm
	Projection	
Customer Client	Date	
Drawn By Dessiné Par	BoxCad: BoxCad	Date 15-Aug-14
Material Matière	14 Ga Cold Rolled A1008 CS Type B (1.7mm)	
Color Couleur	Light Grey RAL7035	Finish Fini Textured
Description	6412ESW 1200mm x 800mm x 270mm Assembly	Detail Rev.
Part Number Numéro Pièce	6412ESW081230	Rev. 0
		2 / 9

This drawing is confidential and must not be reproduced or used without the consent of EXM

Ce dessin est confidentiel et ne doit pas être reproduit ou utilisé sans le consentement de EXM

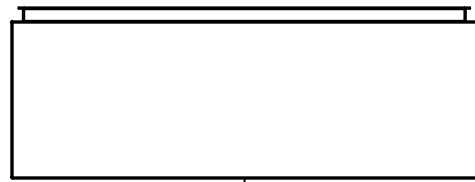

TOP

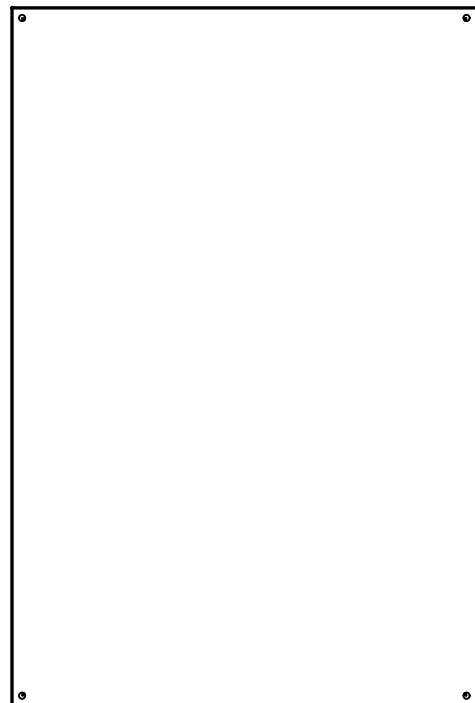

BACK

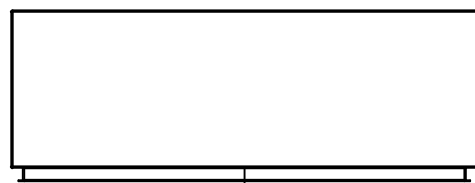

BOTTOM

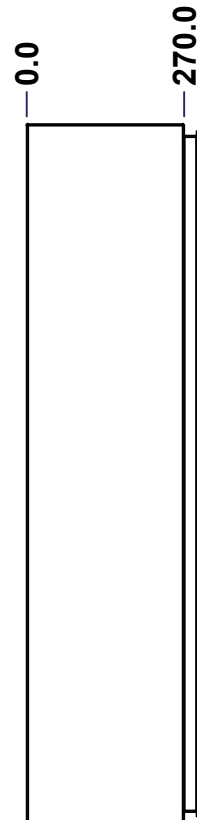

LEFT

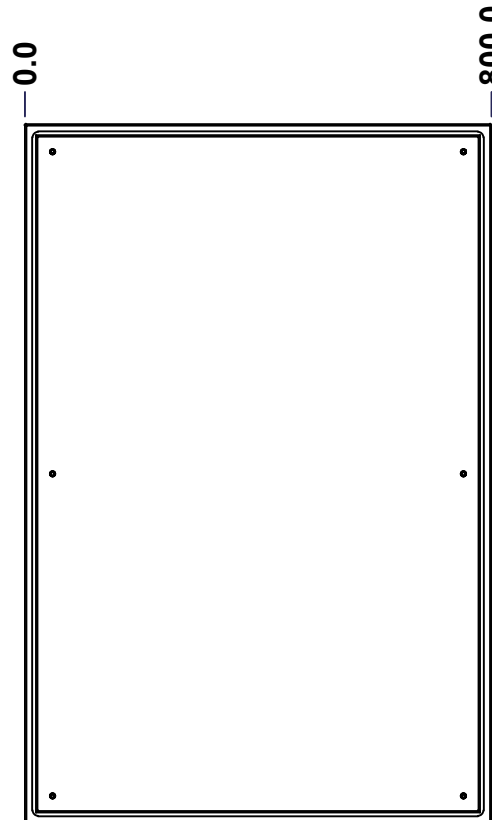

FRONT

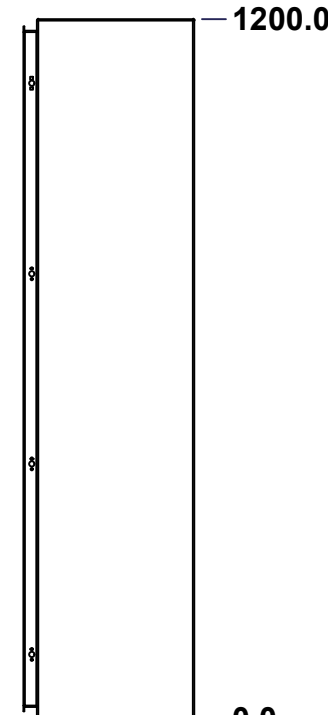

RIGHT

No.	Revisions	Date	By/Par

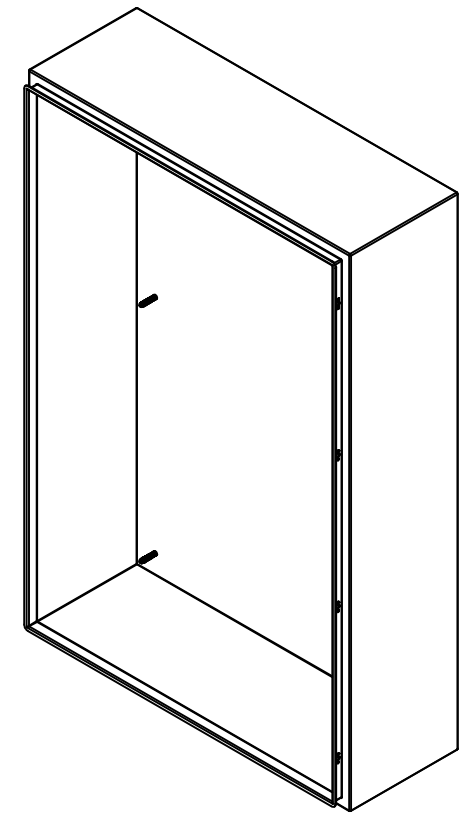

Isometric View



Tél: (450) 979-4373
 Fax: (450) 979-4626
www.exmweb.com

Flatness
Aplatissement

Max 3.0mm

Projection

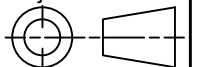

Customer Client	Date
Drawn By Dessiné Par BoxCad: BoxCad	Date 15-Aug-14
Material Matière 14 Ga Cold Rolled A1008 CS Type B (1.7mm)	
Color Couleur Light Grey RAL7035	Finish Fini Textured
Description 6412ESW 1200mm x 800mm x 270mm Body	Detail Rev.
Part Number Numéro Pièce 6412ESW081230B	Rev. 3 0

SEE BILL OF MATERIAL ON LAST PAGE

This drawing is confidential and must not be reproduced or used without the consent of EXM

Ce dessin est confidentiel et ne doit pas être reproduit ou utilisé sans le consentement de EXM

STANDARD FEATURES ARE NOT LISTED IN THIS HOLE TABLE			
HOLE TABLE - RIGHT VIEW (CUSTOM FEATURE ONLY)			
CUT-OUT	XDIM	YDIM	DESCRIPTION
1	231.9	50.8	GND STUD M6 x 16mm (Inside)
2	219.2	1149.2	LABEL_EXM (Inside)

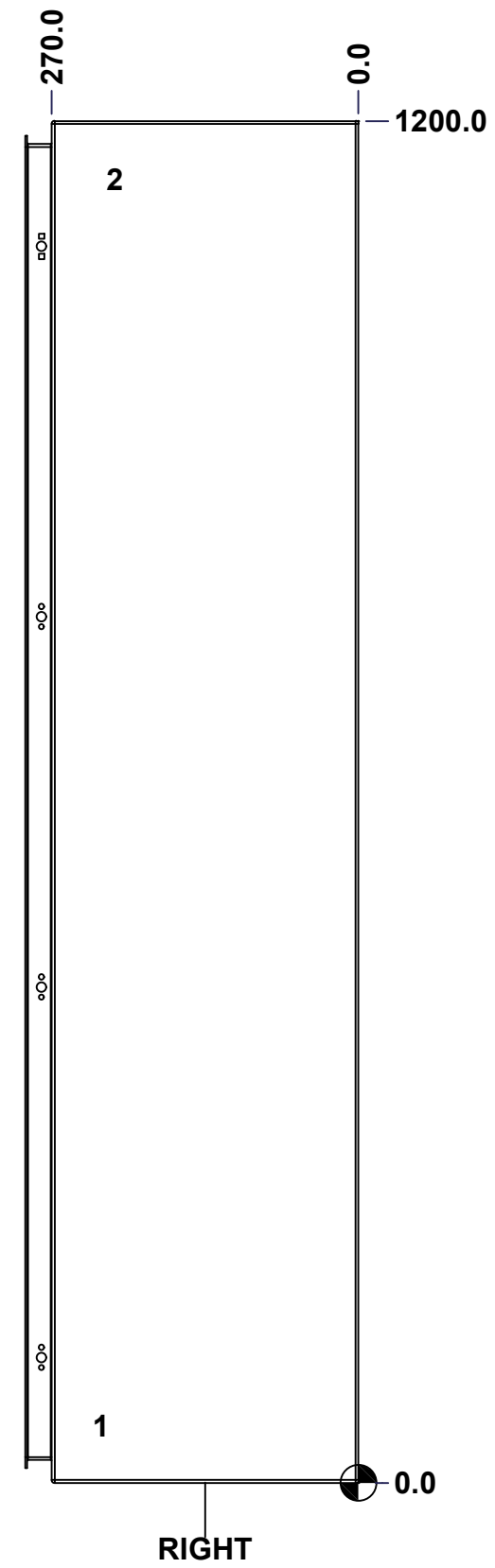

	Description 6412ESW 1200mm x 800mm x 270mm Body		Status (NULL)
	Part Number Numéro Pièce 6412ESW081230B		Rev. 4 0 / 9

This drawing is confidential and must not be reproduced or used without the consent of EXM

Ce dessin est confidentiel et ne doit pas être reproduit ou utilisé sans le consentement de EXM

STANDARD FEATURES ARE NOT LISTED IN THIS HOLE TABLE

HOLE TABLE - BACK VIEW (CUSTOM FEATURE ONLY)

CUT-OUT	XDIM	YDIM	DESCRIPTION
1	47.6	47.6	IP STUD M8 x 35mm (Inside)
2	47.6	1152.4	IP STUD M8 x 35mm (Inside)
3	752.4	1152.4	IP STUD M8 x 35mm (Inside)
4	752.4	47.6	IP STUD M8 x 35mm (Inside)
5	47.6	600.0	IP STUD M8 x 35mm (Inside)
6	752.4	600.0	IP STUD M8 x 35mm (Inside)

7	781.0	19.1	RND Ø9.9
8	781.0	1181.0	RND Ø9.9
9	19.1	1181.0	RND Ø9.9
10	19.1	19.1	RND Ø9.9

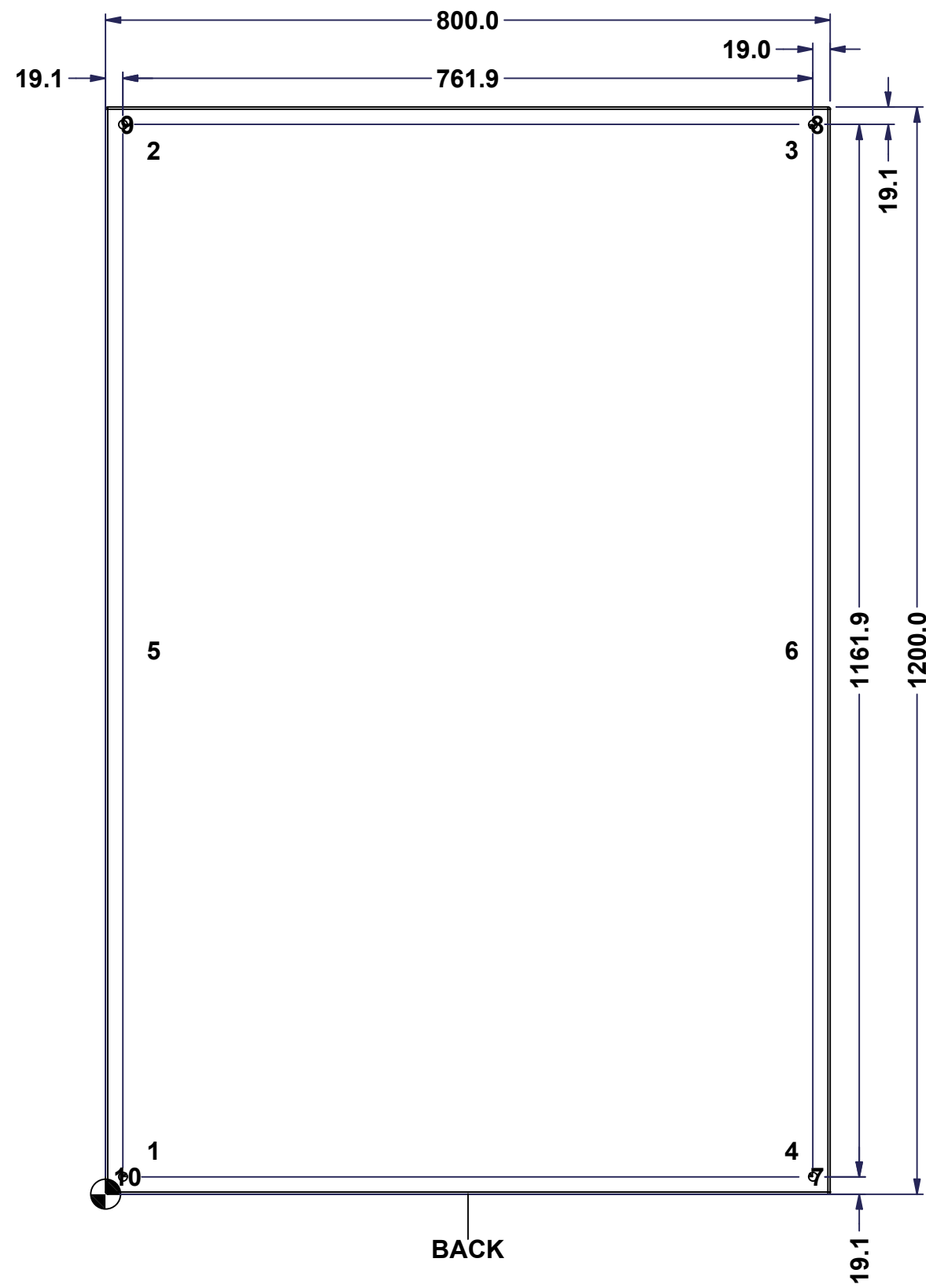

BACK

	Description 6412ESW 1200mm x 800mm x 270mm Body	Status (NULL)
	Part Number Numéro Pièce 6412ESW081230B	Rev. 5 0 / 9

This drawing is confidential and must not be reproduced or used without the consent of EXM

Ce dessin est confidentiel et ne doit pas être reproduit ou utilisé sans le consentement de EXM

No.	Revisions	Date	By/Par

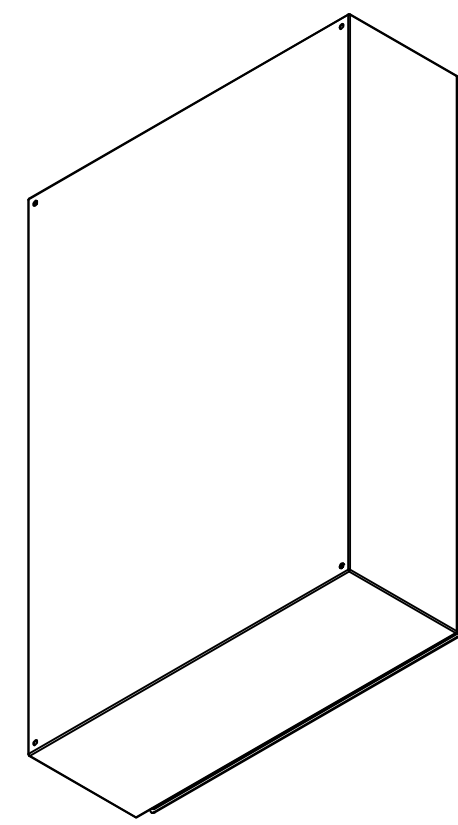

Isometric View

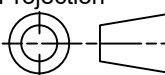

 Tél: (450) 979-4373 Fax: (450) 979-4626 www.exmweb.com		Flatness Aplatissement Max 3.0mm
Customer Client		Projection 
Drawn By Dessiné Par BoxCad: BoxCad		Date 15-Aug-14
Material Matière 14 Ga Cold Rolled A1008 CS Type B (1.7mm)		
Color Couleur Light Grey RAL7035	Finish Fini Textured	
Description 6412ESW 1200mm x 800mm x 270mm Body		Detail Rev.
Part Number Numéro Pièce 6412ESW081230B		Rev. 6 0

Qty	Part Number	Rev	Description
1	STK-S-00100	0	3.5" x 2" Silver Milar Flexcon Sticker
1	STK-Q-16080	0	Ground Stud M6 x 16mm Steel
1	STK-P-03820R	0	Powder Paint (Light Grey / Rough Textured)
6	STK-Q-16005	0	Stud M8 x 35mm Steel
1	6412ESW081230B-P	0	6412ESW 1200mm x 800mm x 270mm Body Part
Parts List			

This drawing is confidential and must not be reproduced or used without the consent of EXM

Ce dessin est confidentiel et ne doit pas être reproduit ou utilisé sans le consentement de EXM

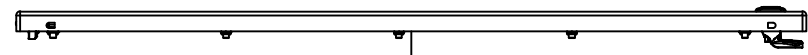

TOP

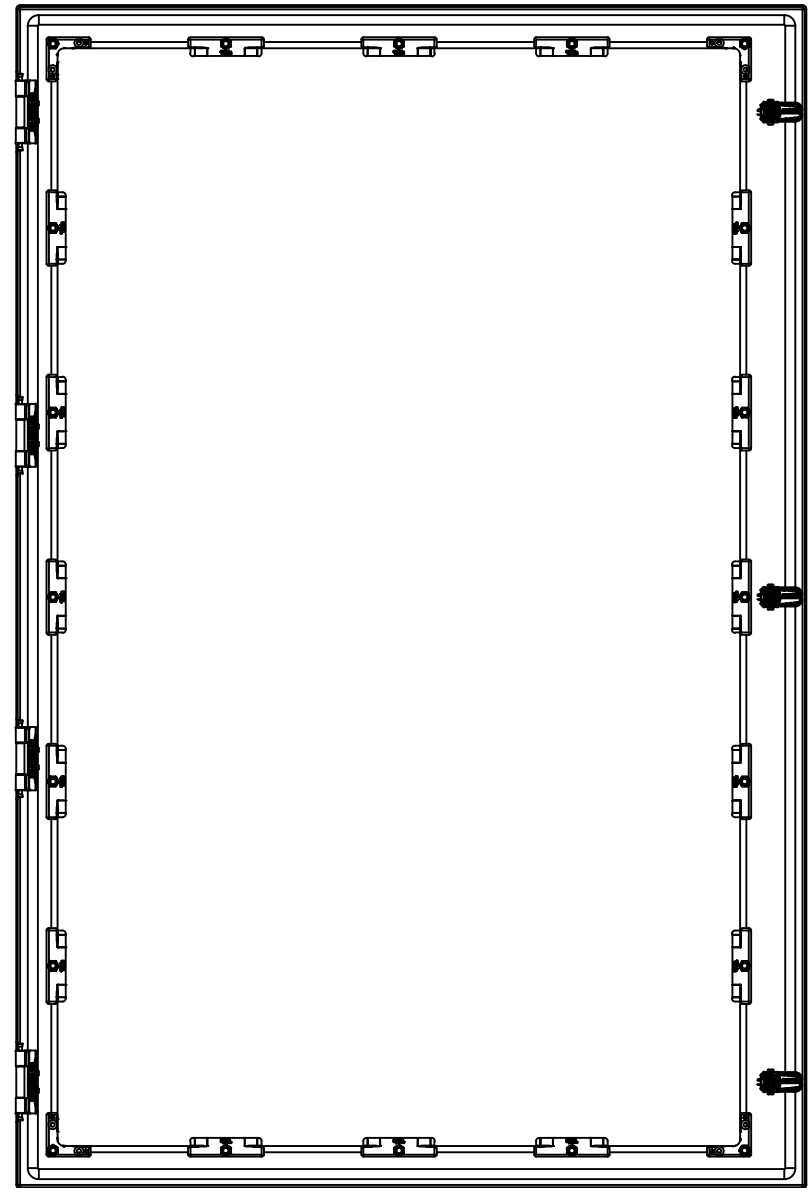

BACK

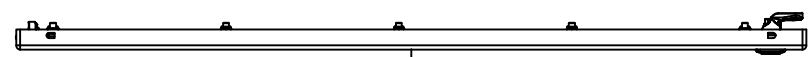

BOTTOM

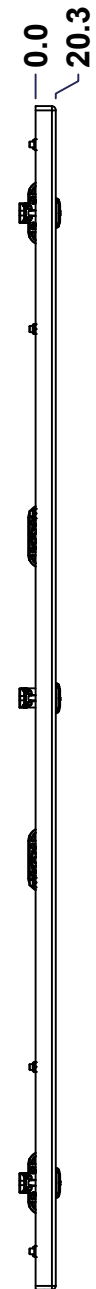

LEFT

0.0
20.3

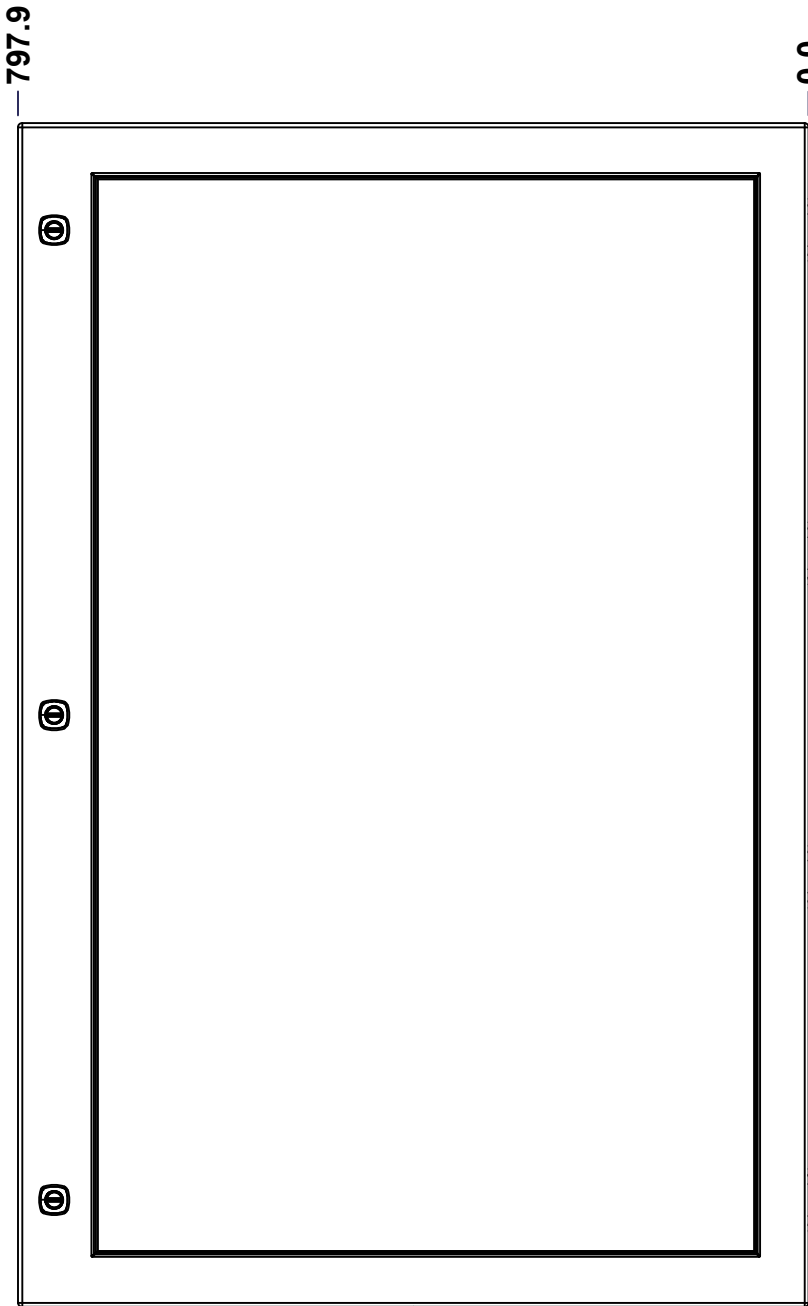

FRONT

797.9
0.0

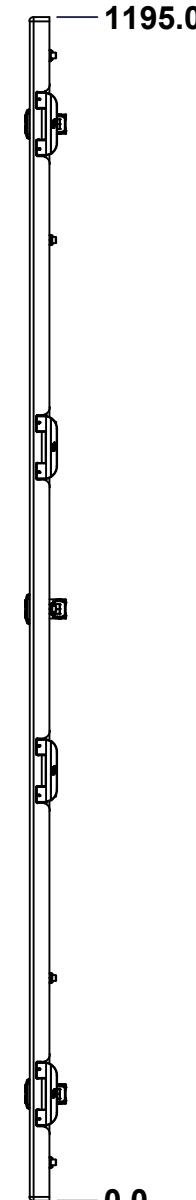

RIGHT

1195.0

0.0

No.	Revisions	Date	By/Par

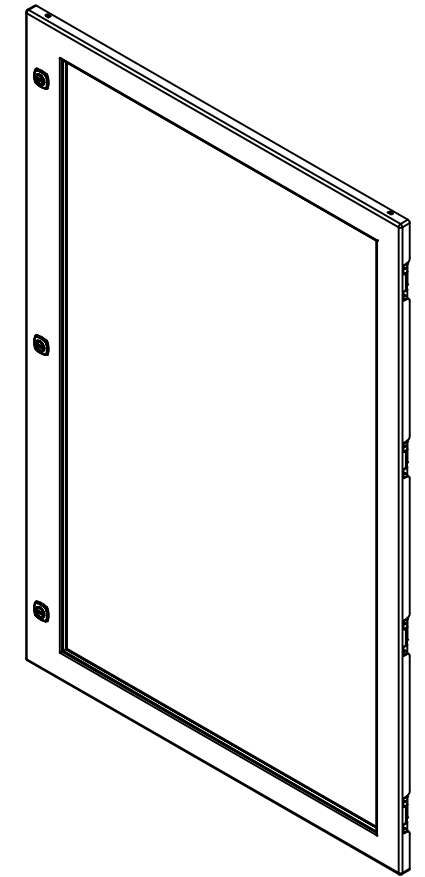

Isometric View



Tél: (450) 979-4373
Fax: (450) 979-4626
www.exmweb.com

Flatness
Aplatissement
Max 3.0mm
Projection

Customer Client	Date
Drawn By Dessiné Par BoxCad: BoxCad	Date 15-Aug-14
Material Matière 14 Ga Cold Rolled A1008 CS Type B (1.7mm)	
Color Couleur Light Grey RAL7035	Finish Fini Textured
Description 6412ESW 1200mm x 800mm Cover	Detail Rev.
Part Number Numéro Pièce 6412ESW081230C	Rev. 7 0

SEE BILL OF MATERIAL ON LAST PAGE

This drawing is confidential and must not be reproduced or used without the consent of EXM

Ce dessin est confidentiel et ne doit pas être reproduit ou utilisé sans le consentement de EXM

STANDARD FEATURES ARE NOT LISTED IN THIS HOLE TABLE

HOLE TABLE - FRONT VIEW (CUSTOM FEATURE ONLY)

CUT-OUT	XDIM	YDIM	DESCRIPTION
1	37.3	225.0	STUD M6 x 25mm (Inside)
2	735.7	225.0	STUD M6 x 25mm (Inside)
3	37.3	411.3	STUD M6 x 25mm (Inside)
4	735.7	411.3	STUD M6 x 25mm (Inside)
5	37.3	597.5	STUD M6 x 25mm (Inside)
6	735.7	597.5	STUD M6 x 25mm (Inside)
7	37.3	783.7	STUD M6 x 25mm (Inside)
8	735.7	783.7	STUD M6 x 25mm (Inside)
9	37.3	970.0	STUD M6 x 25mm (Inside)
10	735.7	970.0	STUD M6 x 25mm (Inside)
11	37.3	1156.2	STUD M6 x 25mm (Inside)
12	37.3	38.8	STUD M6 x 25mm (Inside)
13	211.9	1156.2	STUD M6 x 25mm (Inside)
14	211.9	38.8	STUD M6 x 25mm (Inside)
15	386.5	1156.2	STUD M6 x 25mm (Inside)
16	386.5	38.8	STUD M6 x 25mm (Inside)
17	561.1	1156.2	STUD M6 x 25mm (Inside)
18	561.1	38.8	STUD M6 x 25mm (Inside)
19	735.7	1156.2	STUD M6 x 25mm (Inside)
20	735.7	38.8	STUD M6 x 25mm (Inside)

21	761.7	1087.0	LOCK 880 SCQ4-SL @ 180.0°
22	761.7	597.5	LOCK 880 SCQ4-SL @ 180.0°
23	761.7	108.0	LOCK 880 SCQ4-SL @ 180.0°

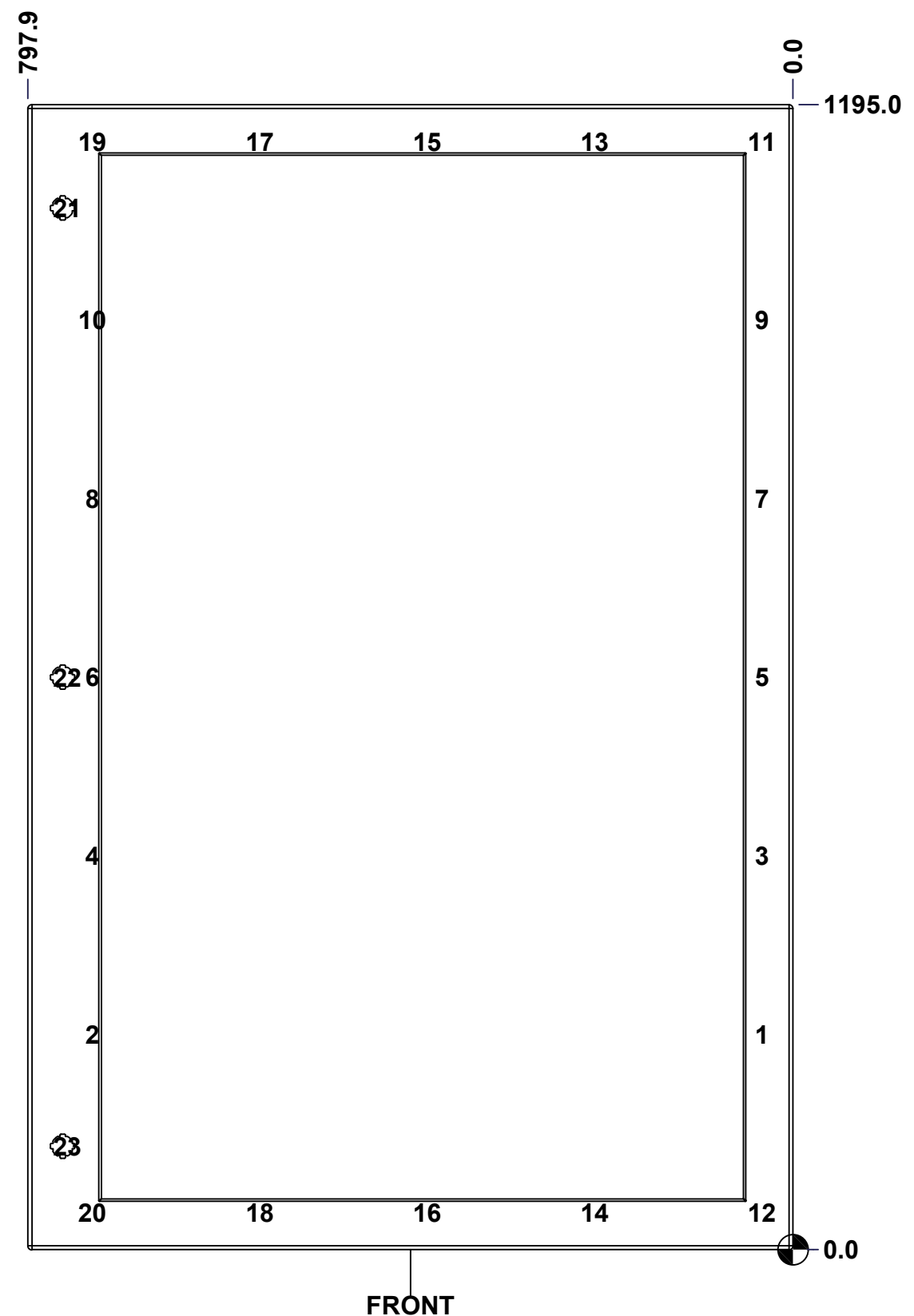

FRONT

	Description	Status
	6412ESW 1200mm x 800mm Cover	(NULL)
	Part Number	Rev.
	Numéro Pièce 6412ESW081230C	0
		8
		9

This drawing is confidential and must not be reproduced or used without the consent of EXM

Ce dessin est confidentiel et ne doit pas être reproduit ou utilisé sans le consentement de EXM

No.	Revisions	Date	By/Par

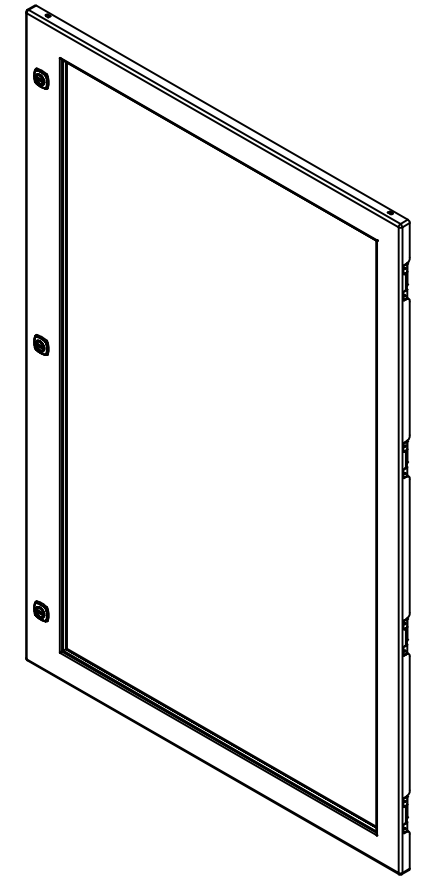

Isometric View

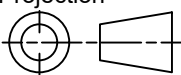

QTY	Part Number	Rev	Description
3	STK-K-12500	19	5412 ES 1/4 Turn Lock
1	STK-P-03820R	0	Powder Paint (Light Grey / Rough Textured)
1	STK-A-60703	0	5412 ESW Lexan Bracket Kit
20	STK-Q-16012	0	Stud M6 x 25mm Steel
1	STK-G-02710	0	880 HWKG - Windows Kit Gasket
1	6412ESW081230LXG	0	6412ESW 1200mm x 800mm Lexan Gasket Part
1	6412ESW081230LX	0	6412ESW 1107.9mm x 701.6mm Lexan Part
1	6412ESW081230G	0	6412ESW 1200mm x 800mm Cover Gasket Part
1	6412ESW081230C-P	0	6412ESW 1200mm x 800mm Cover Part
4	STK-K-09800		5412 ES Hinge with 2 Captive Hinge Pins
16	STK-Q-60701	2.1	880 WK - Lexan 1/4" Fixing Bracket
Parts List			

 Tél: (450) 979-4373 Fax: (450) 979-4626 www.exmweb.com	Flatness Aplatissement Max 3.0mm
	Projection 
Customer Client	Date
Drawn By Dessiné Par BoxCad: BoxCad	Date 15-Aug-14
Material Matière	14 Ga Cold Rolled A1008 CS Type B (1.7mm)
Color Couleur	Light Grey RAL7035
Finish Fini	Textured
Description	Detail Rev.
6412ESW 1200mm x 800mm Cover	
Part Number Numéro Pièce	Rev.
6412ESW081230C	0
	9
	9

This drawing is confidential and must not be reproduced or used without the consent of EXM

Ce dessin est confidentiel et ne doit pas être reproduit ou utilisé sans le consentement de EXM

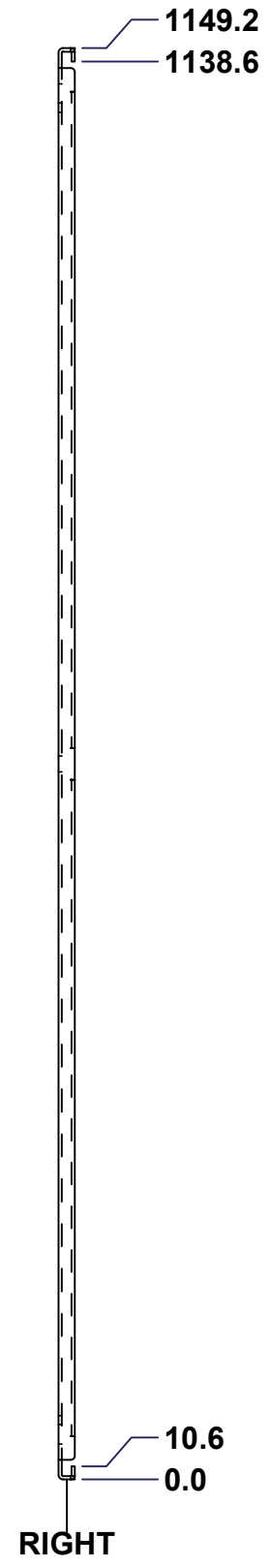
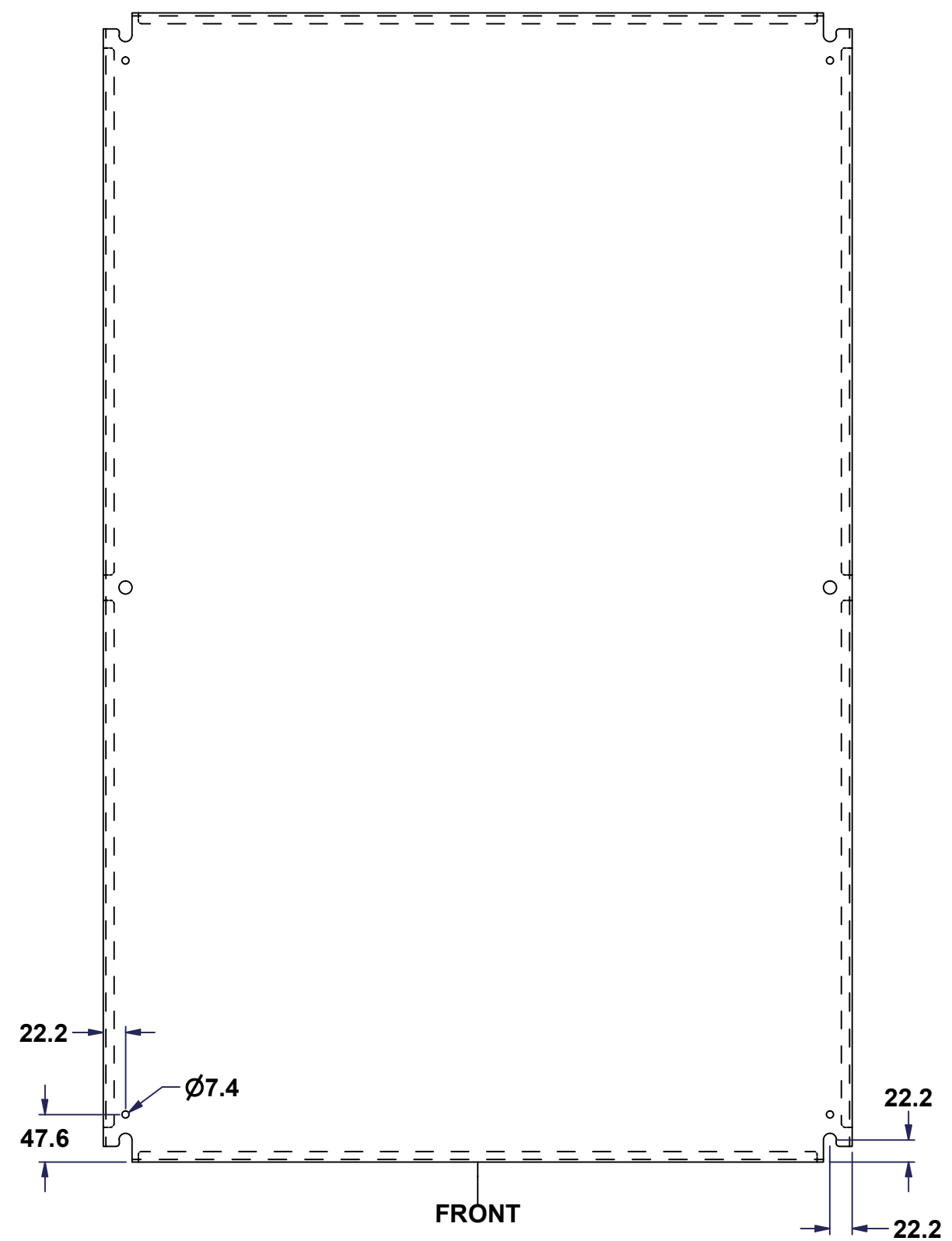
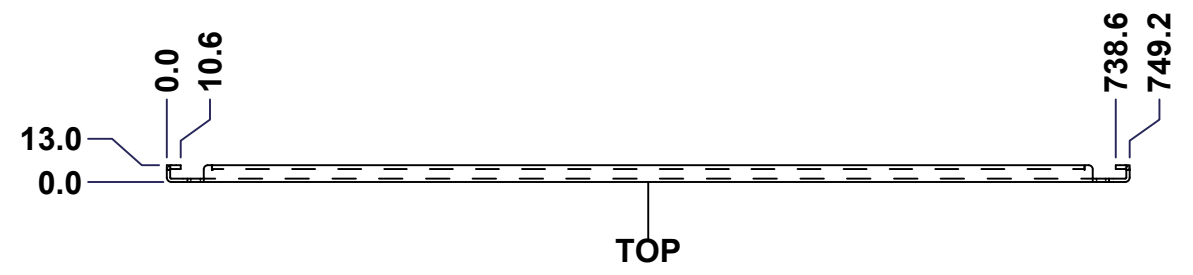

SEE BILL OF MATERIAL ON LAST PAGE

No.	Revisions	Date	By/Par

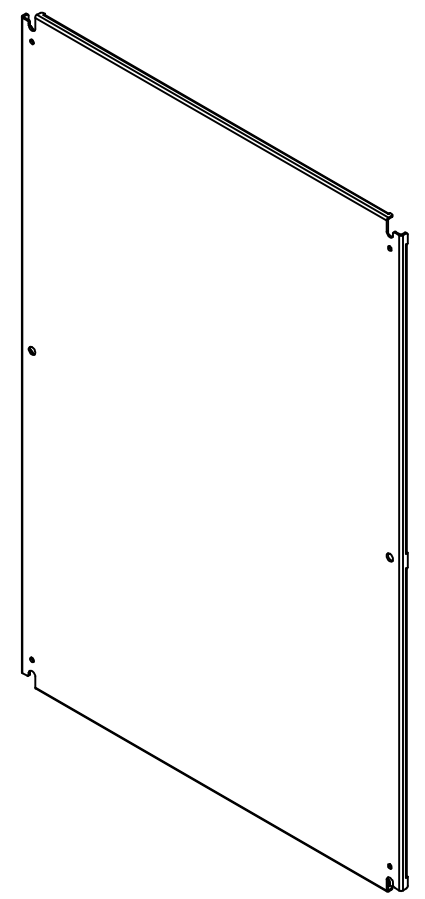

Tél: (450) 979-4373 Fax: (450) 979-4626 www.exmweb.com	Flatness Aplatissement	Max 3.0mm
	Projection	
Customer Client	Date	
Drawn By Dessiné Par	BoxCad	Date 23-Jan-07
Material Matière	12 Ga Galvanized (2.5mm)	
Color Couleur	Unpainted	Finish Fini Unpainted
Description	Detail Rev.	
886 SP - Inner Panel		
Part Number Numéro Pièce	Rev.	1
886 SP0812ES	0	2

This drawing is confidential and must not be reproduced or used without the consent of EXM

Ce dessin est confidentiel et ne doit pas être reproduit ou utilisé sans le consentement de EXM

No.	Revisions	Date	By/Par

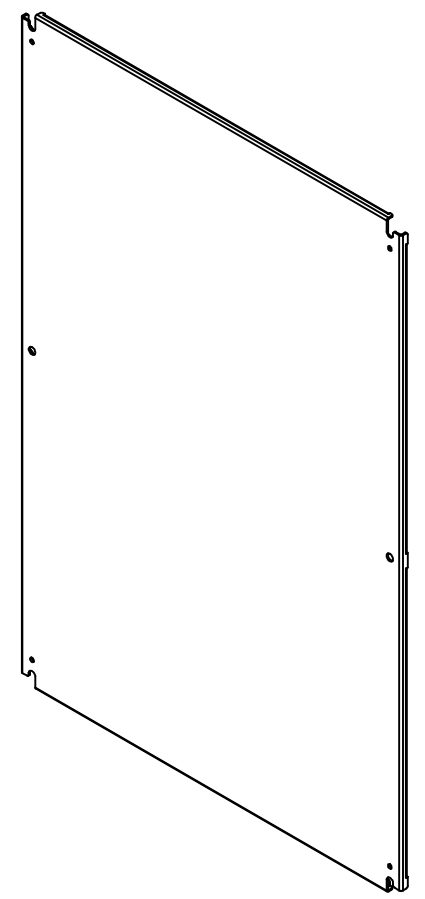

Isometric View



 Tél: (450) 979-4373 Fax: (450) 979-4626 www.exmweb.com		Flatness Aplatissement Max 3.0mm
Customer Client		Date
Drawn By / Dessiné Par: BoxCad		Date: 23-Jan-07
Material / Matière: 12 Ga Galvanized (2.5mm)		
Color / Couleur: Unpainted	Finish / Fini: Unpainted	
Description: 886 SP - Inner Panel		Detail Rev.
Part Number / Numéro Pièce: 886 SP0812ES		Rev. 0 / 2

Qty	Part Number	Rev	Description
1	886 SP0812ES-P	0	886 SP - Inner Panel Part
Parts List			