

This drawing is confidential and must not be reproduced or used without the consent of EXM

Ce dessin est confidentiel et ne doit pas être reproduit ou utilisé sans le consentement de EXM

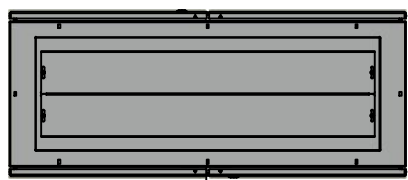

TOP

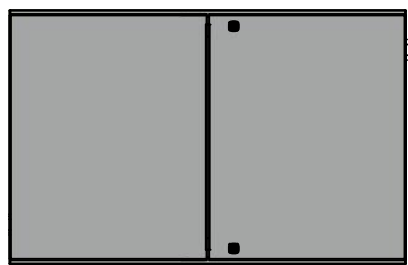

BACK

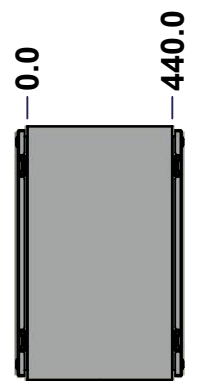

LEFT

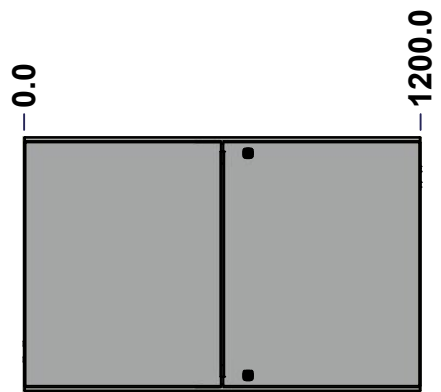

FRONT

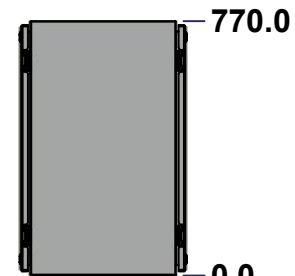

RIGHT

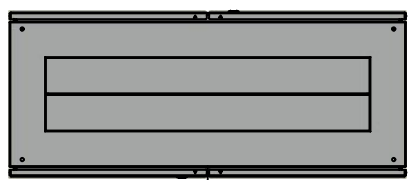

BOTTOM

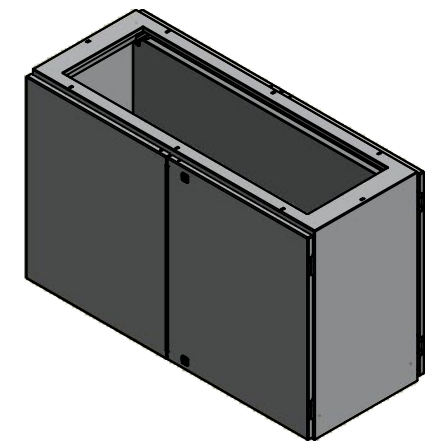

Isometric View

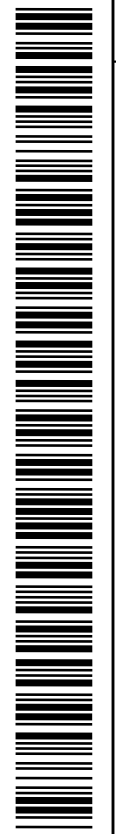

No.	Revisions	Date	By/Par

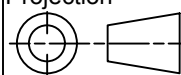
 Tél: (450) 979-4373 Fax: (450) 979-4626 www.exmweb.com		Flatness Aplatissement Max 3.0mm Projection 
Customer Client	Date	
Drawn By Dessiné Par	BoxCad: BoxCad	Date 04-Aug-15
Material Matière	14 Ga Cold Rolled A1008 CS Type B (1.7mm)	
Color Couleur	Light Grey RAL7035	Finish Fini Rough Textured
Description 6500MCOODD 770mm x 1200mm x 500mm Assembly		Detail Rev.
Part Number Numéro Pièce	6500MCOODD1205	Rev. 1 0

SEE BILL OF MATERIAL ON LAST PAGE

This drawing is confidential and must not be reproduced or used without the consent of EXM

Ce dessin est confidentiel et ne doit pas être reproduit ou utilisé sans le consentement de EXM

NOTE	
ITEM	DESCRIPTION
1	NEMA 12/13 Enclosure
2	C/W Standard ground studs on box and cover
3	C/W Standard door stiffener
4	C/W Special inner panel (Sold separately)
5	C/W Standard inner panel mounting studs

No.	Revisions	Date	By/Par

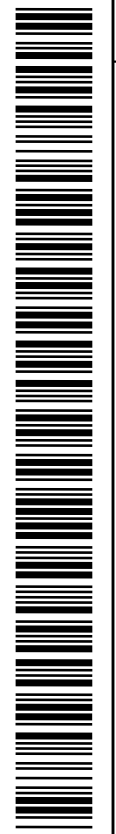
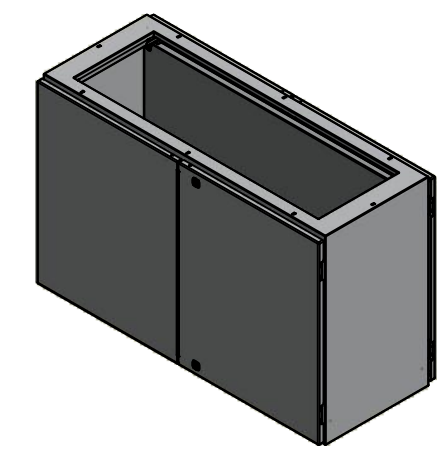

Isometric View



Tél: (450) 979-4373
 Fax: (450) 979-4626
www.exmweb.com

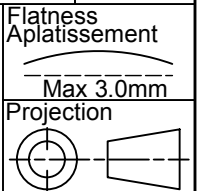

Customer Client	Date
Drawn By / Dessiné Par: BoxCad: BoxCad	Date: 04-Aug-15

Material / Matière: 14 Ga Cold Rolled A1008 CS Type B (1.7mm)

Color / Couleur: Light Grey RAL7035
 Finish / Fini: Rough Textured

Description: 6500MCOODD 770mm x 1200mm x 500mm Assembly
 Detail Rev.

Part Number / Numéro Pièce: **6500MCOODD1205**
 Rev. 0

PACKING		
ITEM	QTY	DESCRIPTION
Cardboard corner	2	To reinforced for the plastic strap tightening
Honeycomb angle	4	To protect each corners
Plastic strap- Green	2	To secure the enclosure to the wood pallet
Wood pallet	1	Standard wood pallet
Flat cardboard	1	Between the enclosure and the wood pallet
Packaging label	1	White label with product number

Qty	Part Number	Rev	Description
4	STK-Q-00700	2	M8 x 12mm Hex Socket Cap Screw (DIN 6912)
1	6500MCOODD1205IP	0	6500MCOODD 770mm x 1200mm Inner Panel Part
1	6500MCOODD1205BR	0	6500MCOODD 770mm x 1200mm Back Lock Door
1	6500MCOODD1205BL	0	6500MCOODD 770mm x 1200mm Back Flange Door
1	6500MCOODD1205FR	0	6500MCOODD 770mm x 1200mm Front Lock Door
1	6500MCOODD1205FL	0	6500MCOODD 770mm x 1200mm Front Flange Door
1	6500MCOODD1205B	0	6500MCOODD 770mm x 1200mm x 500mm Body
8	STK-Q-04050-07	7	M6 x 7mm Hexagon Socket Head Machine Screw with Nyseal

Parts List

This drawing is confidential and must not be reproduced or used without the consent of EXM

Ce dessin est confidentiel et ne doit pas être reproduit ou utilisé sans le consentement de EXM

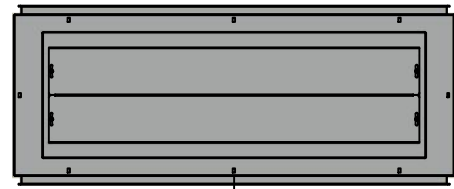

TOP



BACK

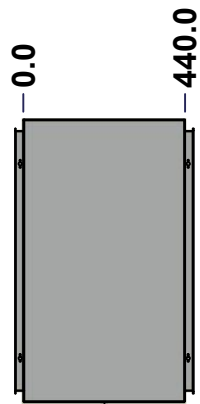

LEFT

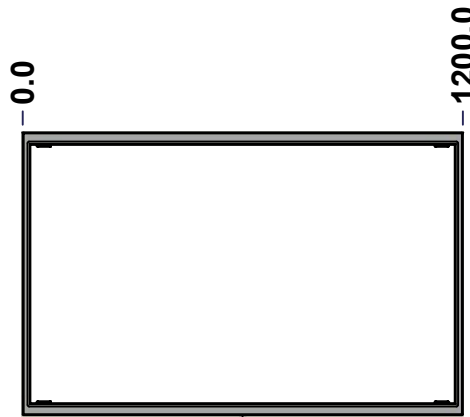

FRONT

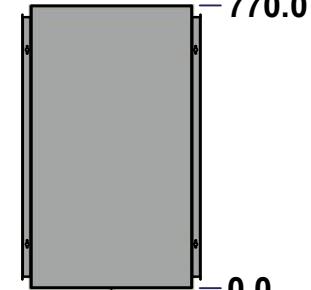

RIGHT



BOTTOM

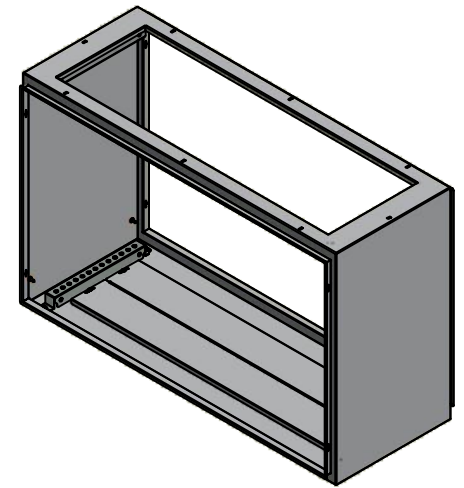

Isometric View

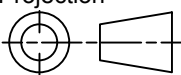

No.	Revisions	Date	By/Par

 Tél: (450) 979-4373 Fax: (450) 979-4626 www.exmweb.com	Flatness Aplatissement	Max 3.0mm
	Projection	
Customer Client	Date	
Drawn By Dessiné Par	BoxCad: BoxCad	Date 04-Aug-15
Material Matière	14 Ga Cold Rolled A1008 CS Type B (1.7mm)	
Color Couleur	Light Grey RAL7035	Finish Fini
		Rough Textured
Description	Detail Rev.	
6500MCOOD 770mm x 1200mm x 500mm Body		
Part Number Numéro Pièce	Rev.	3
6500MCOOD1205B	0	22

SEE BILL OF MATERIAL ON LAST PAGE

This drawing is confidential and must not be reproduced or used without the consent of EXM

Ce dessin est confidentiel et ne doit pas être reproduit ou utilisé sans le consentement de EXM

STANDARD FEATURES ARE NOT LISTED IN THIS HOLE TABLE

HOLE TABLE - TOP VIEW (CUSTOM FEATURE ONLY)

CUT-OUT	XDIM	YDIM	DESCRIPTION
1	58.0	25.0	STUD M6 x 18mm (Inside)
2	1142.0	25.0	STUD M6 x 18mm (Inside)
3	58.0	415.0	STUD M6 x 18mm (Inside)
4	1142.0	415.0	STUD M6 x 18mm (Inside)

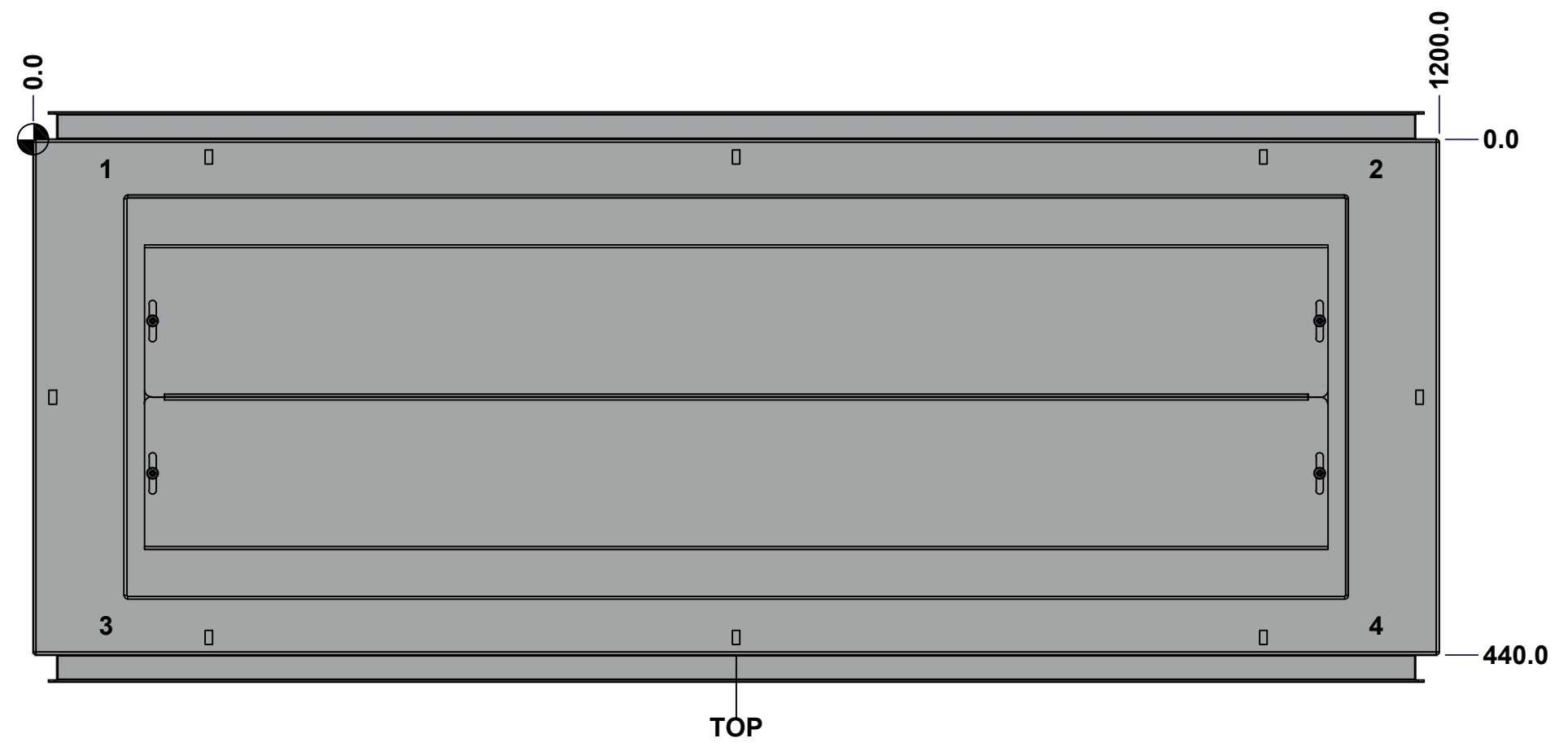

	Description 6500MCOOD 770mm x 1200mm x 500mm Body	Status (NULL)
	Part Number Numéro Pièce 6500MCOOD1205B	Rev. 4 0

This drawing is confidential and must not be reproduced or used without the consent of EXM

Ce dessin est confidentiel et ne doit pas être reproduit ou utilisé sans le consentement de EXM

STANDARD FEATURES ARE NOT LISTED IN THIS HOLE TABLE			
HOLE TABLE - RIGHT VIEW (CUSTOM FEATURE ONLY)			
CUT-OUT	XDIM	YDIM	DESCRIPTION
1	415.0	75.0	GND STUD M6 x 16mm (Inside)
2	25.0	75.0	GND STUD M6 x 16mm (Inside)

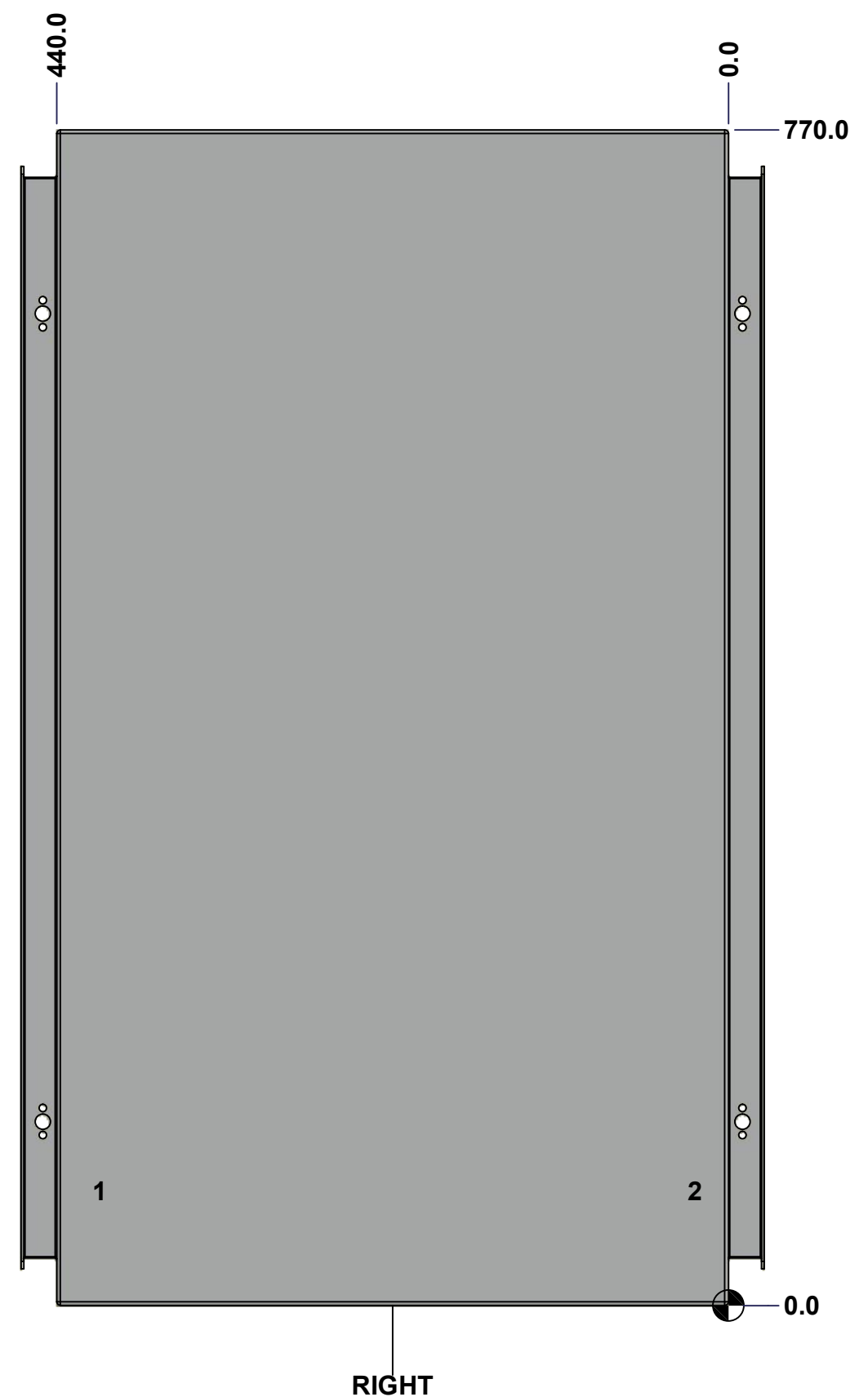

RIGHT

	Description 6500MCOODD 770mm x 1200mm x 500mm Body		Status (NULL)	
	Part Number Numéro Pièce 6500MCOODD1205B		Rev. 0	5 22

This drawing is confidential and must not be reproduced or used without the consent of EXM

Ce dessin est confidentiel et ne doit pas être reproduit ou utilisé sans le consentement de EXM

STANDARD FEATURES ARE NOT LISTED IN THIS HOLE TABLE

HOLE TABLE - BOTTOM VIEW (CUSTOM FEATURE ONLY)

CUT-OUT	XDIM	YDIM	DESCRIPTION
1	58.0	25.0	STUD M6 x 18mm (Inside)
2	1142.0	25.0	STUD M6 x 18mm (Inside)
3	58.0	415.0	STUD M6 x 18mm (Inside)
4	1142.0	415.0	STUD M6 x 18mm (Inside)

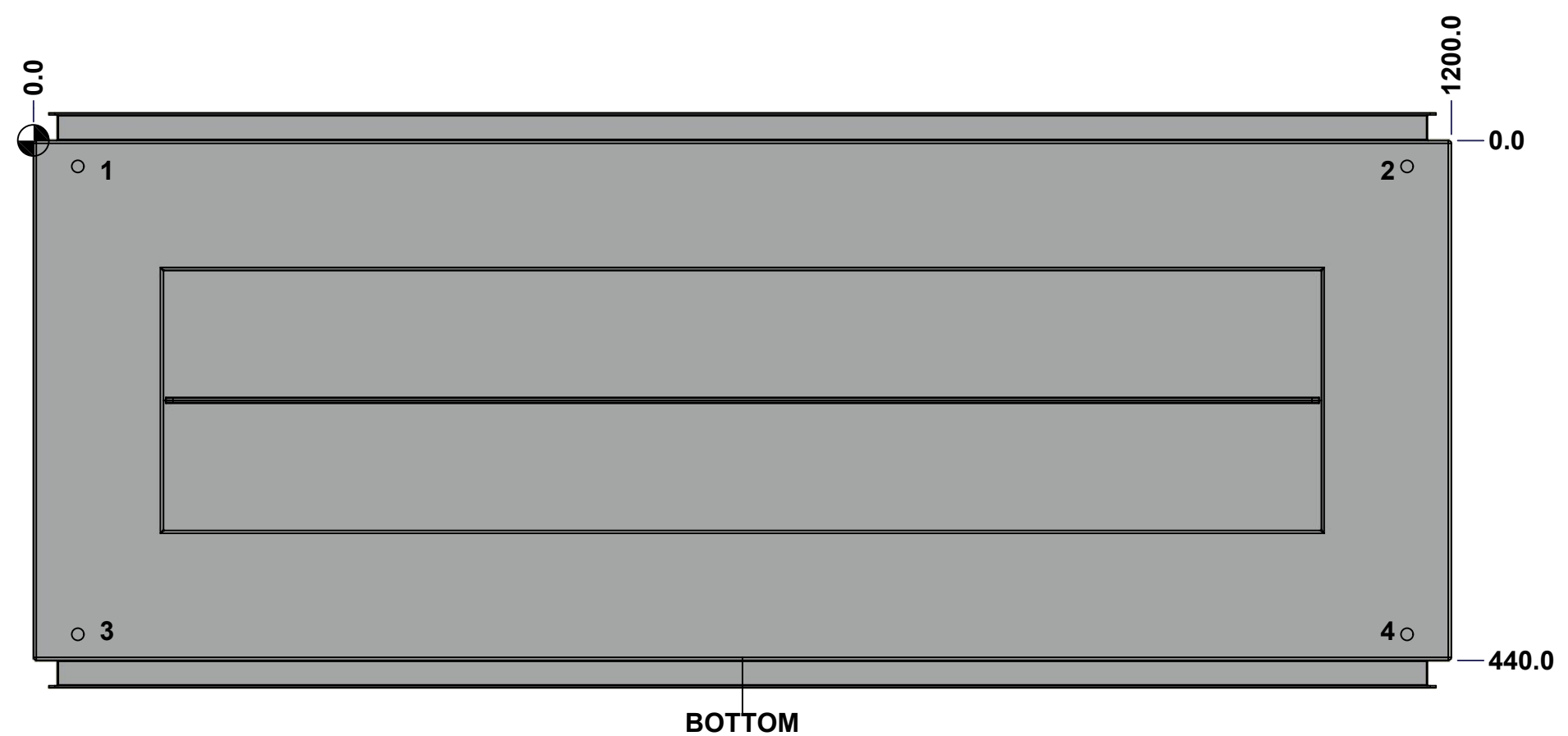

	Description 6500MCOODD 770mm x 1200mm x 500mm Body		Status (NULL)	
	Part Number Numéro Pièce 6500MCOODD1205B		Rev. 0	6 22

This drawing is confidential and must not be reproduced or used without the consent of EXM

Ce dessin est confidentiel et ne doit pas être reproduit ou utilisé sans le consentement de EXM

STANDARD FEATURES ARE NOT LISTED IN THIS HOLE TABLE			
HOLE TABLE - LEFT VIEW (CUSTOM FEATURE ONLY)			
CUT-OUT	XDIM	YDIM	DESCRIPTION
1	415.0	75.0	GND STUD M6 x 16mm (Inside)
2	25.0	75.0	GND STUD M6 x 16mm (Inside)

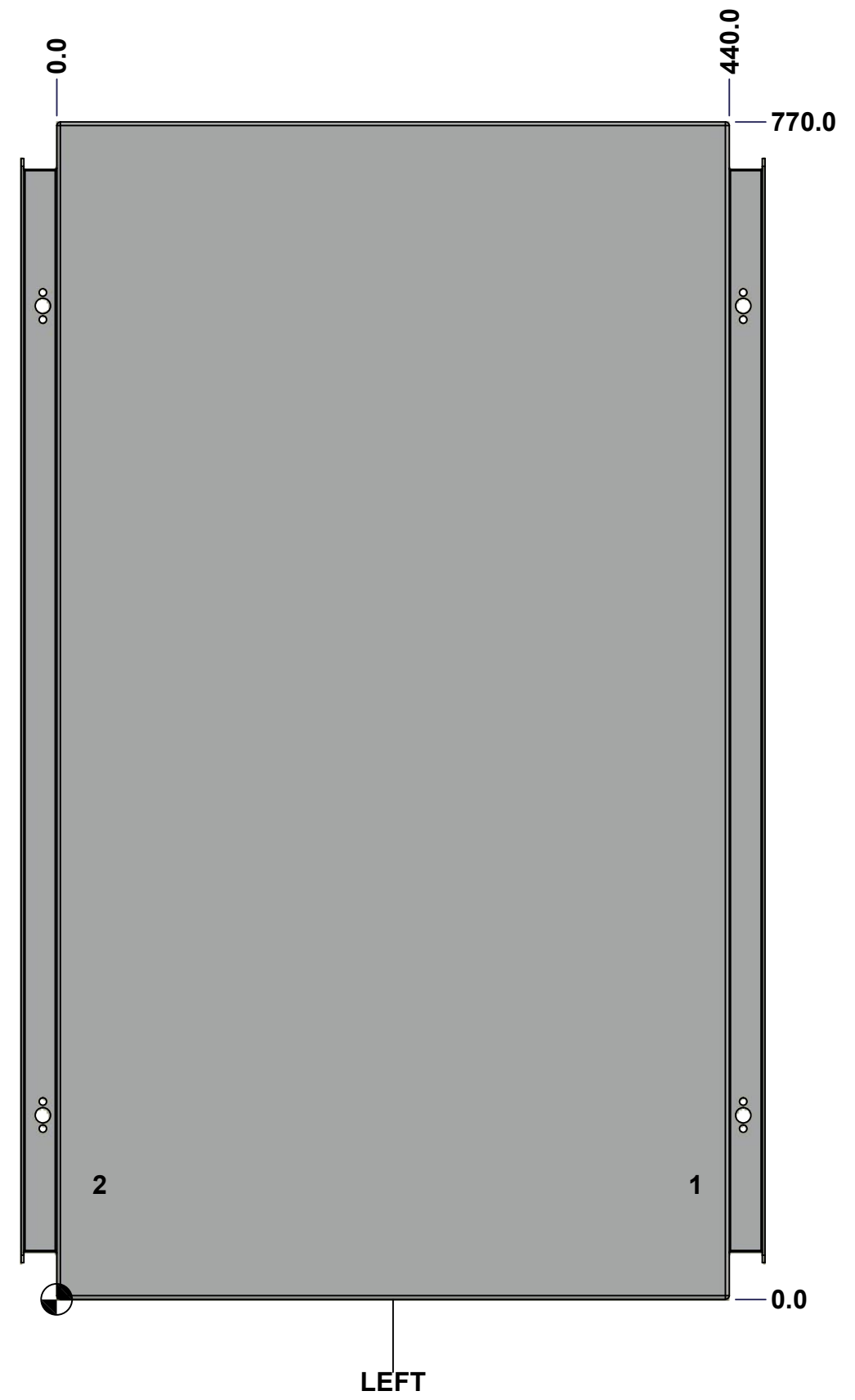

LEFT

	Description 6500MCOODD 770mm x 1200mm x 500mm Body	Status (NULL)
	Part Number Numéro Pièce 6500MCOODD1205B	Rev. 7 0

This drawing is confidential and must not be reproduced or used without the consent of EXM

Ce dessin est confidentiel et ne doit pas être reproduit ou utilisé sans le consentement de EXM

No.	Revisions	Date	By/Par

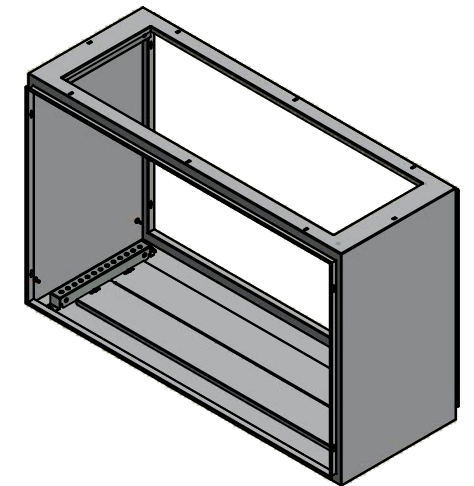

Isometric View



Tél: (450) 979-4373
 Fax: (450) 979-4626
www.exmweb.com

Flatness
Aplatissement
Max 3.0mm
Projection

Customer Client	Date
Drawn By / Dessiné Par: BoxCad: BoxCad	Date: 04-Aug-15

Material / Matière: 14 Ga Cold Rolled A1008 CS Type B (1.7mm)

Color / Couleur: Light Grey RAL7035	Finish / Fini: Rough Textured
-------------------------------------	-------------------------------

Description: 6500MCODD 770mm x 1200mm x 500mm Body

Part Number / Numéro Pièce: 6500MCODD1205B	Rev. / Révis: 0	8	22
---	------------------------	---	----

Qty	Part Number	Rev	Description
1	6500MCODD1205GP	0	6500MCODD 770mm x 1200mm x 500mm Gland Plate
4	STK-Q-16080	0	Ground Stud M6 x 16mm
1	STK-P-03820R	0	Powder Paint (Light Grey / Rough Textured)
4	STK-Q-49090-350	2	Mounting Rail 350.0mm
8	STK-Q-16031	0	M6 x 10mm Stud (No Paint Cap Required)
1	6500MCODD1205B-P	0	6500MCODD 770mm x 1200mm x 500mm Body Part
8	STK-Q-07220	1	M6 Nylon Insert Lock Nut
Parts List			

This drawing is confidential and must not be reproduced or used without the consent of EXM

Ce dessin est confidentiel et ne doit pas être reproduit ou utilisé sans le consentement de EXM



TOP

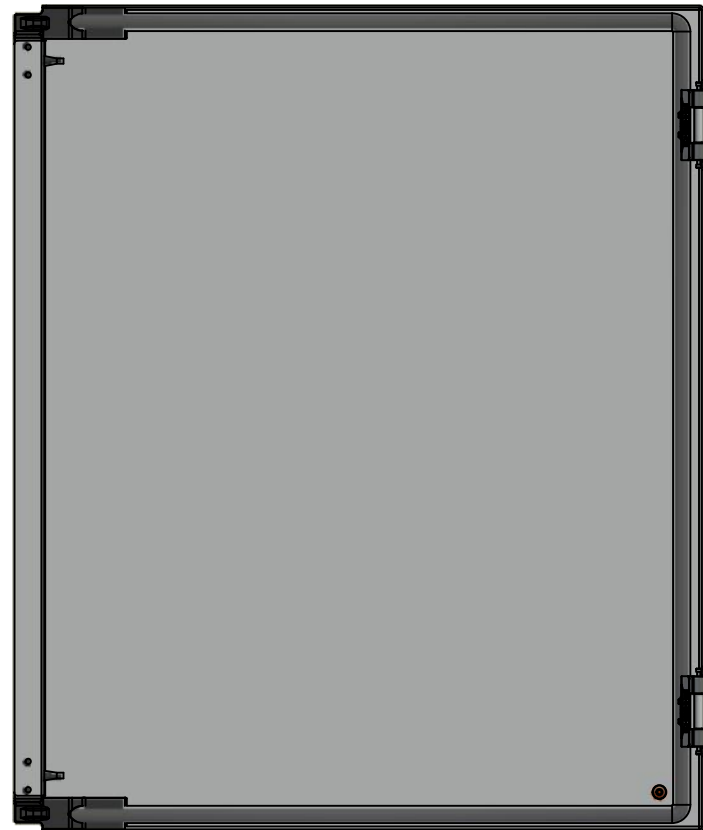

BACK



BOTTOM

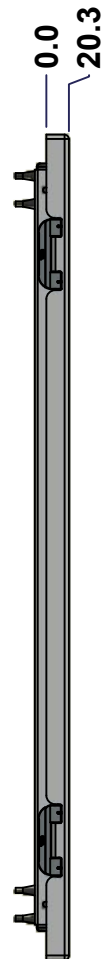

LEFT

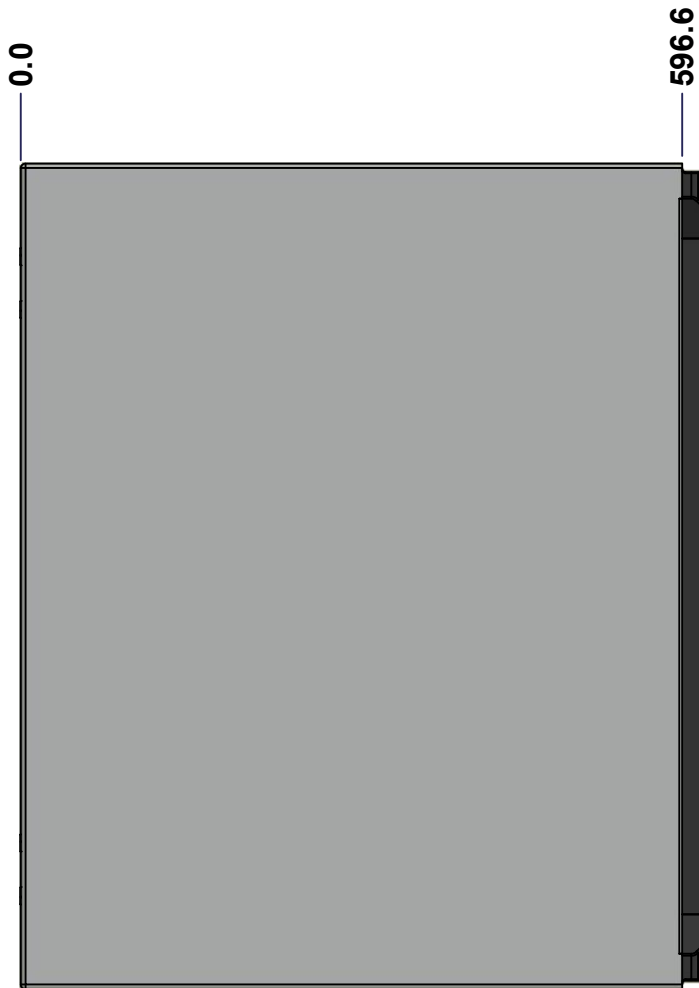

FRONT

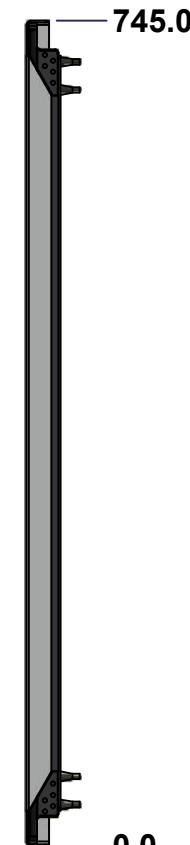

RIGHT

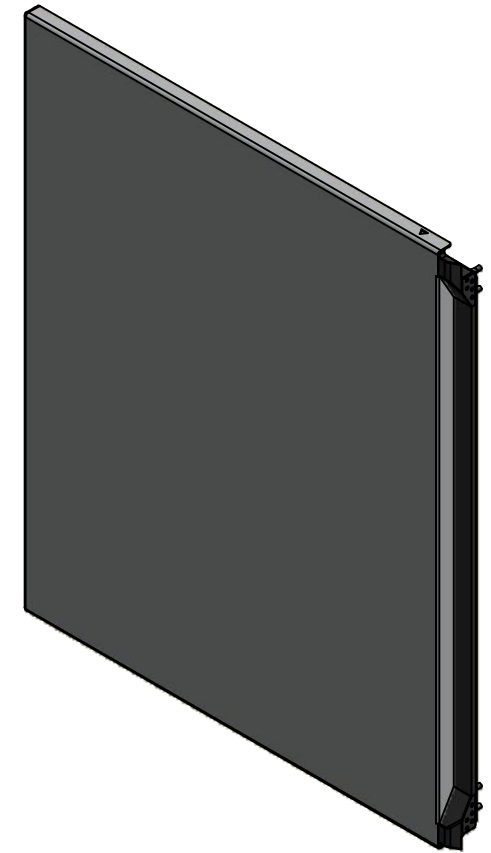

Isometric View

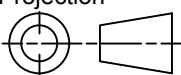

No.	Revisions	Date	By/Par

 Tél: (450) 979-4373 Fax: (450) 979-4626 www.exmweb.com		Flatness Aplatissement Max 3.0mm Projection 
Customer Client	Date	
Drawn By Dessiné Par	BoxCad: BoxCad	Date 04-Aug-15
Material Matière	14 Ga Cold Rolled A1008 CS Type B (1.7mm)	
Color Couleur	Light Grey RAL7035	Finish Fini Rough Textured
Description	Detail Rev.	
6500MCOODD 770mm x 1200mm Front Flange Door		
Part Number Numéro Pièce	Rev.	9
6500MCOODD1205FL	0	22

SEE BILL OF MATERIAL ON LAST PAGE

This drawing is confidential and must not be reproduced or used without the consent of EXM

Ce dessin est confidentiel et ne doit pas être reproduit ou utilisé sans le consentement de EXM

STANDARD FEATURES ARE NOT LISTED IN THIS HOLE TABLE			
HOLE TABLE - FRONT VIEW (CUSTOM FEATURE ONLY)			
CUT-OUT	XDIM	YDIM	DESCRIPTION
1	40.0	35.0	GND STUD M6 x 16mm (Inside)

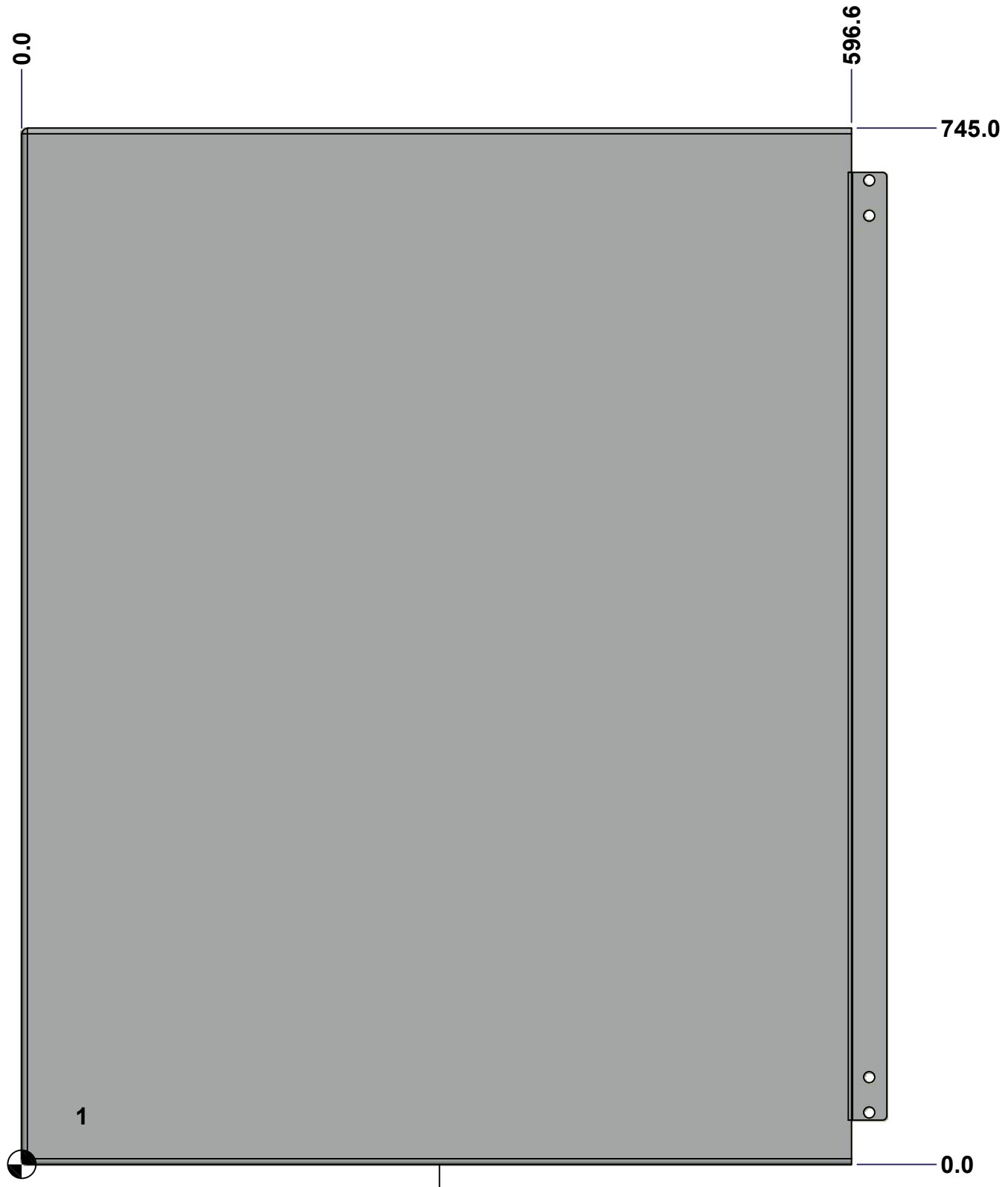

FRONT

	Description 6500MCOODD 770mm x 1200mm Front Flange Door	Status (NULL)
	Part Number Numéro Pièce 6500MCOODD1205FL	Rev. 10 0 22

This drawing is confidential and must not be reproduced or used without the consent of EXM

Ce dessin est confidentiel et ne doit pas être reproduit ou utilisé sans le consentement de EXM

No.	Revisions	Date	By/Par

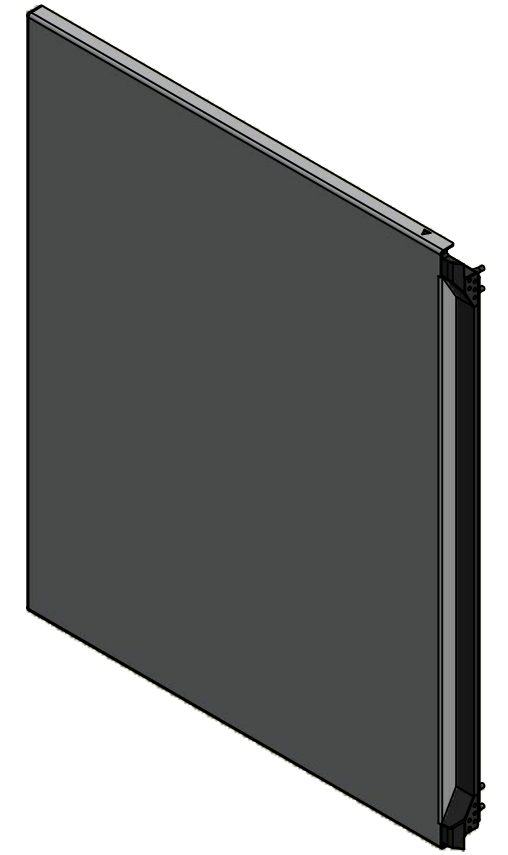

Isometric View

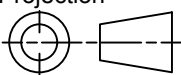

 Tél: (450) 979-4373 Fax: (450) 979-4626 www.exmweb.com	Flatness Aplatissement	Max 3.0mm
	Projection	
Customer Client	Date	
Drawn By Dessiné Par	BoxCad: BoxCad	Date 04-Aug-15
Material Matière	14 Ga Cold Rolled A1008 CS Type B (1.7mm)	
Color Couleur	Light Grey RAL7035	Finish Fini Rough Textured
Description	Detail Rev.	
6500MCODD 770mm x 1200mm Front Flange Door		
Part Number Numéro Pièce	Rev.	11
6500MCODD1205FL	0	22

Qty	Part Number	Rev	Description
1	STK-Q-16080	0	Ground Stud M6 x 16mm
1	STK-P-03820R	0	Powder Paint (Light Grey / Rough Textured)
1	STK-G-03200	6.1	5500 ESDD Lower Flange Door Gasket
1	STK-G-03100	6.1	5500 ESDD Upper Flange Door Gasket
1	STK-G-00701	0	1" x 1/4" Self-Adhesive Neoprene Gasket
1	6500MCODD1205FL-P	0	6500MCODD 770mm x 1200mm Front Flange Door Part
1	6500MCODD1205FL-G	0	6500MCODD 770mm x 1200mm Front Flange Door Gasket
2	STK-K-09800	10	5412 ES Hinge with 2 Captive Hinge Pins
Parts List			

This drawing is confidential and must not be reproduced or used without the consent of EXM

Ce dessin est confidentiel et ne doit pas être reproduit ou utilisé sans le consentement de EXM



TOP

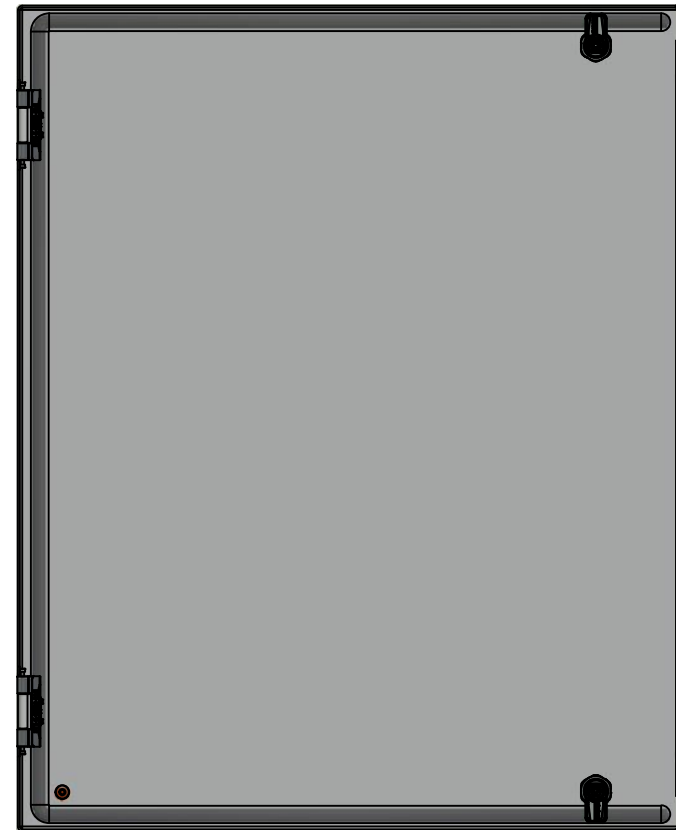

BACK



BOTTOM

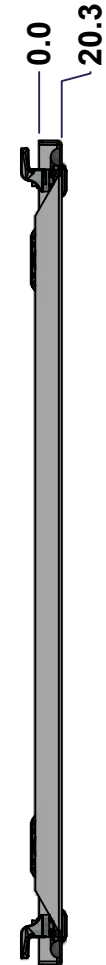

LEFT

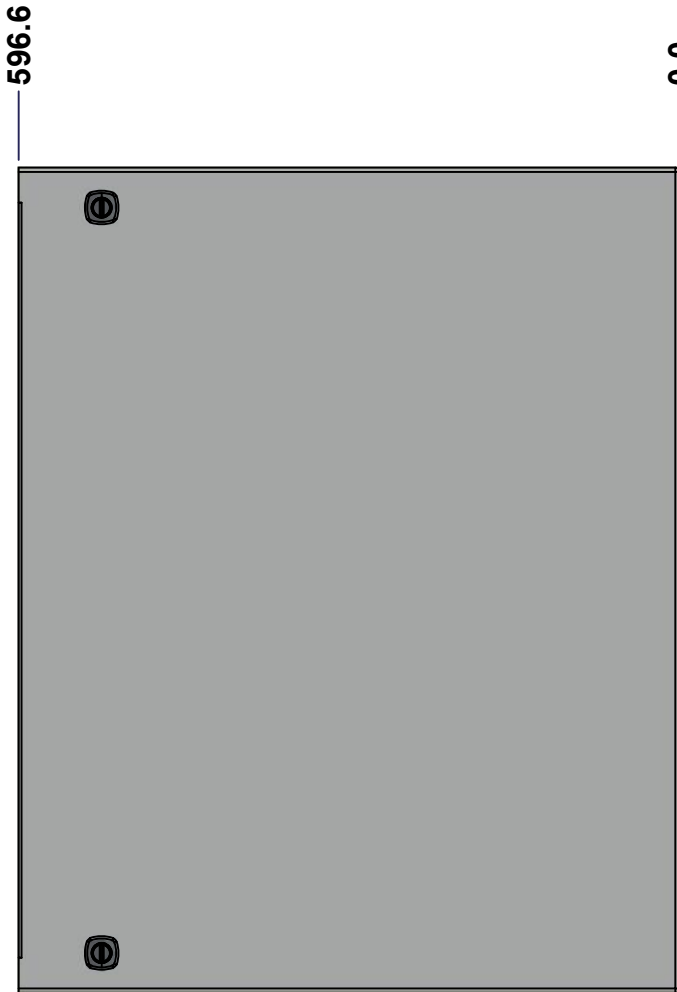

FRONT

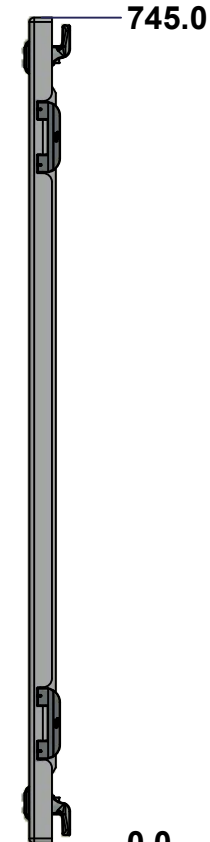

RIGHT

No.	Revisions	Date	By/Par

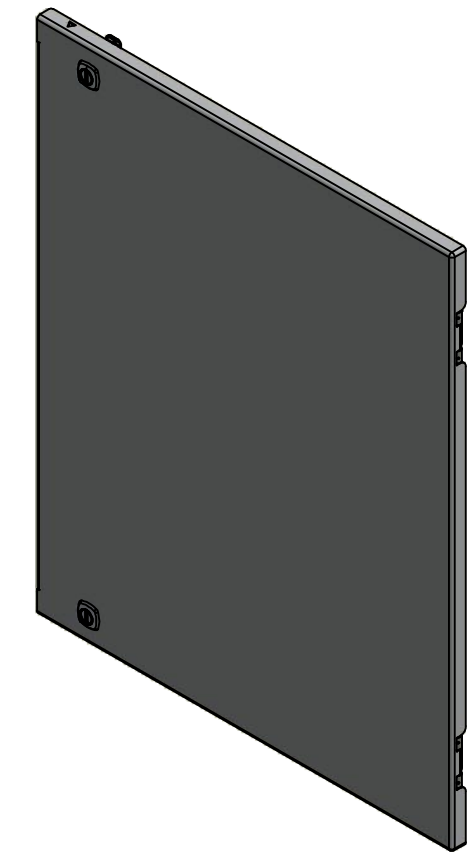

Isometric View



Tél: (450) 979-4373
 Fax: (450) 979-4626
www.exmweb.com

Flatness
Aplatissement
Max 3.0mm
Projection

Customer Client
 Drawn By Dessiné Par BoxCad: BoxCad
 Date 04-Aug-15

Material Matière 14 Ga Cold Rolled A1008 CS Type B (1.7mm)

Color Couleur Light Grey RAL7035
 Finish Fini Rough Textured

Description 6500MCOODD 770mm x 1200mm Front Lock Door
 Detail Rev.

Part Number Numéro Pièce
6500MCOODD1205FR
 Rev. 0
 12 / 22

SEE BILL OF MATERIAL ON LAST PAGE

This drawing is confidential and must not be reproduced or used without the consent of EXM

Ce dessin est confidentiel et ne doit pas être reproduit ou utilisé sans le consentement de EXM

STANDARD FEATURES ARE NOT LISTED IN THIS HOLE TABLE			
HOLE TABLE - FRONT VIEW (CUSTOM FEATURE ONLY)			
CUT-OUT	XDIM	YDIM	DESCRIPTION
1	40.0	35.0	GND STUD M6 x 16mm (Inside)
2	521.6	708.8	LOCK 880 SCQ4-SL @ 90.0°
3	521.6	36.2	LOCK 880 SCQ4-SL @ 270.0°

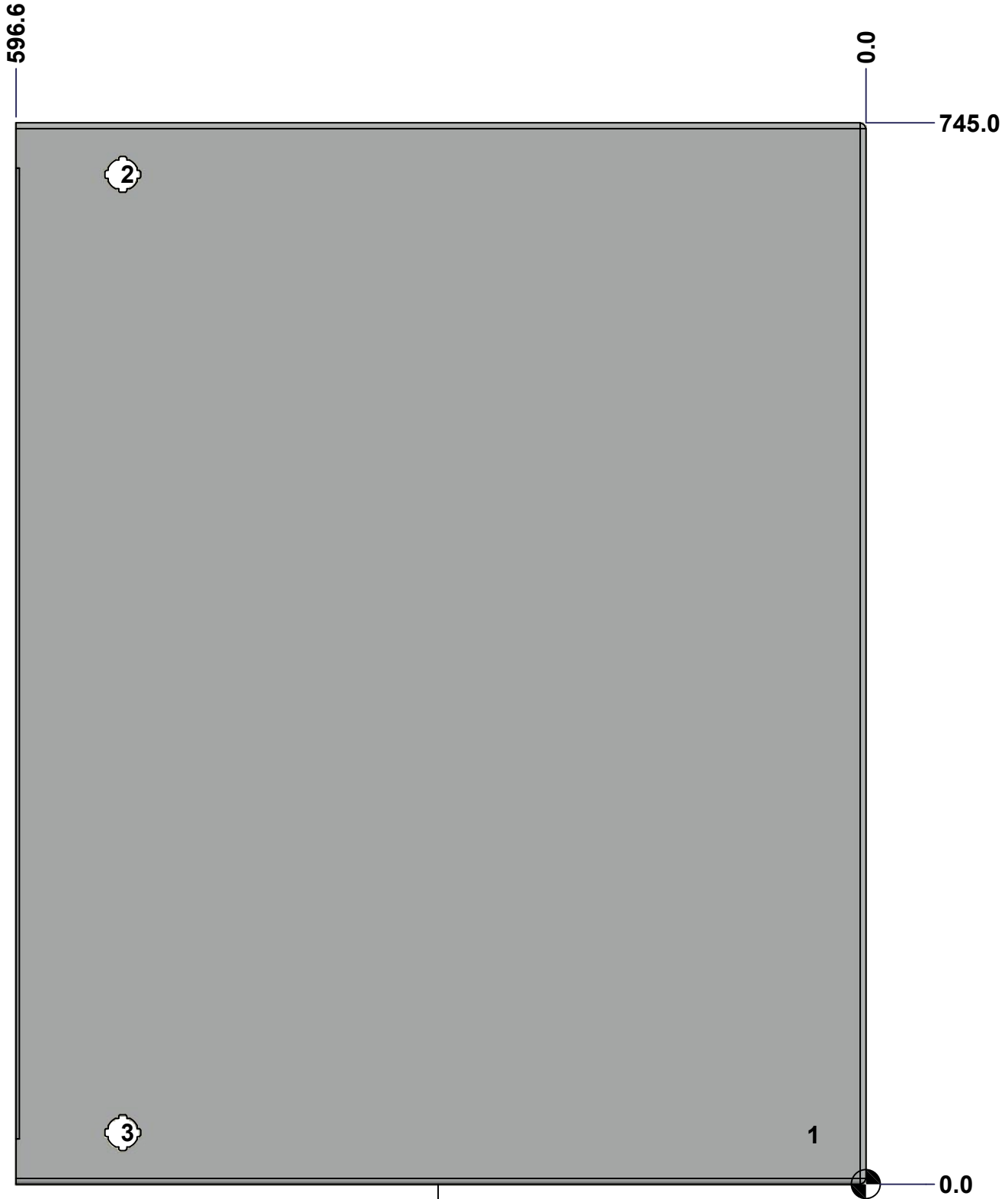

FRONT

	Description 6500MCOODD 770mm x 1200mm Front Lock Door	Status (NULL)
	Part Number Numéro Pièce 6500MCOODD1205FR	Rev. 0 / 13 22

This drawing is confidential and must not be reproduced or used without the consent of EXM

Ce dessin est confidentiel et ne doit pas être reproduit ou utilisé sans le consentement de EXM

No.	Revisions	Date	By/Par

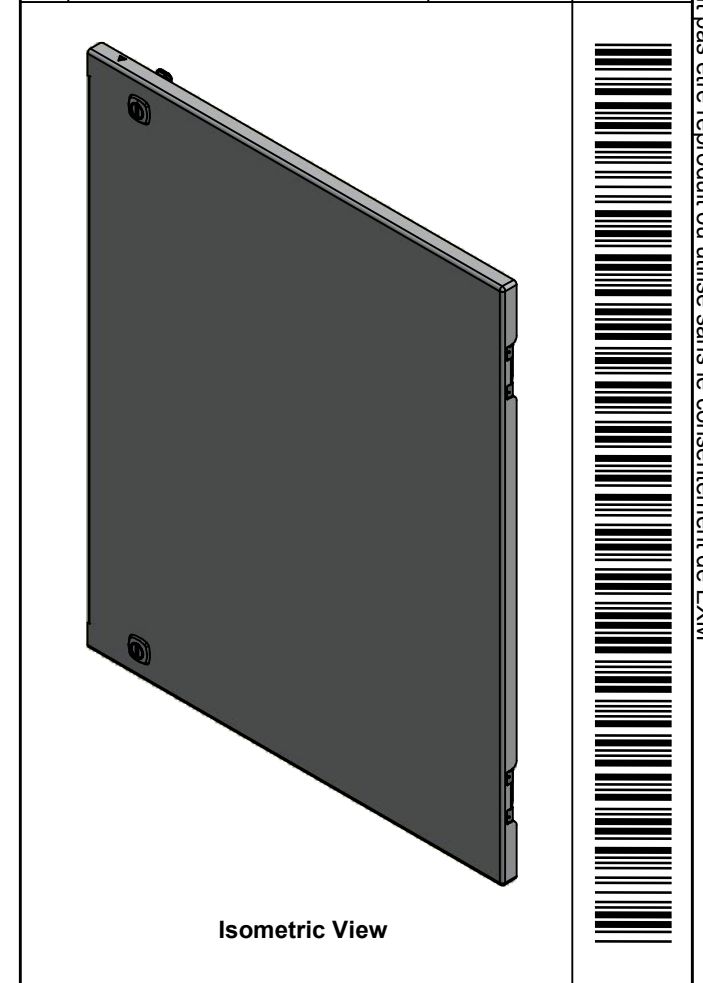

Tél: (450) 979-4373 Fax: (450) 979-4626 www.exmweb.com		Flatness Aplatissement	
		Max 3.0mm	
Customer Client		Date	
Drawn By Dessiné Par BoxCad: BoxCad		Date 04-Aug-15	
Material Matière 14 Ga Cold Rolled A1008 CS Type B (1.7mm)			
Color Couleur Light Grey RAL7035		Finish Fini Rough Textured	
Description 6500MCODD 770mm x 1200mm Front Lock Door			Detail Rev.
Part Number Numéro Pièce		Rev.	14
6500MCODD1205FR		0	22

1	STK-Q-16080	0	Ground Stud M6 x 16mm
1	STK-P-03820R	0	Powder Paint (Light Grey / Rough Textured)
1	6500MCODD1205FR-P	0	6500MCODD 770mm x 1200mm Front Lock Door Part
1	6500MCODD1205FR-G	0	6500MCODD 770mm x 1200mm Front Lock Door Gasket
2	STK-K-09800	10	5412 ES Hinge with 2 Captive Hinge Pins
2	880 SCQ4-SL	6	5412 ES 1/4 Turn Lock
Qty	Part Number	Rev	Description
Parts List			

This drawing is confidential and must not be reproduced or used without the consent of EXM

Ce dessin est confidentiel et ne doit pas être reproduit ou utilisé sans le consentement de EXM



TOP

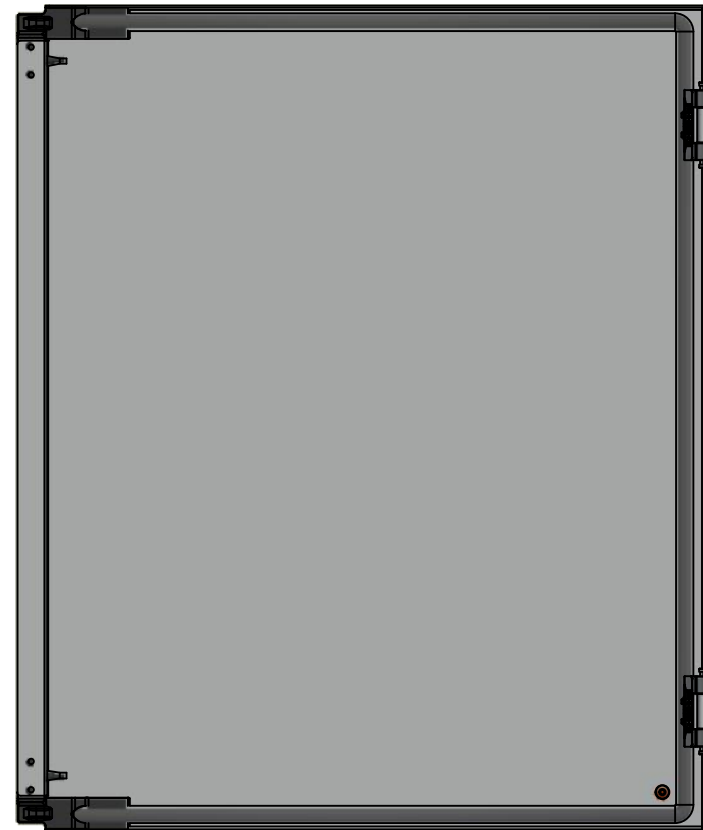

BACK



BOTTOM

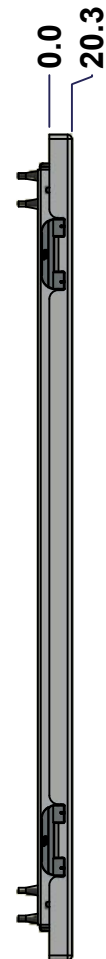

LEFT

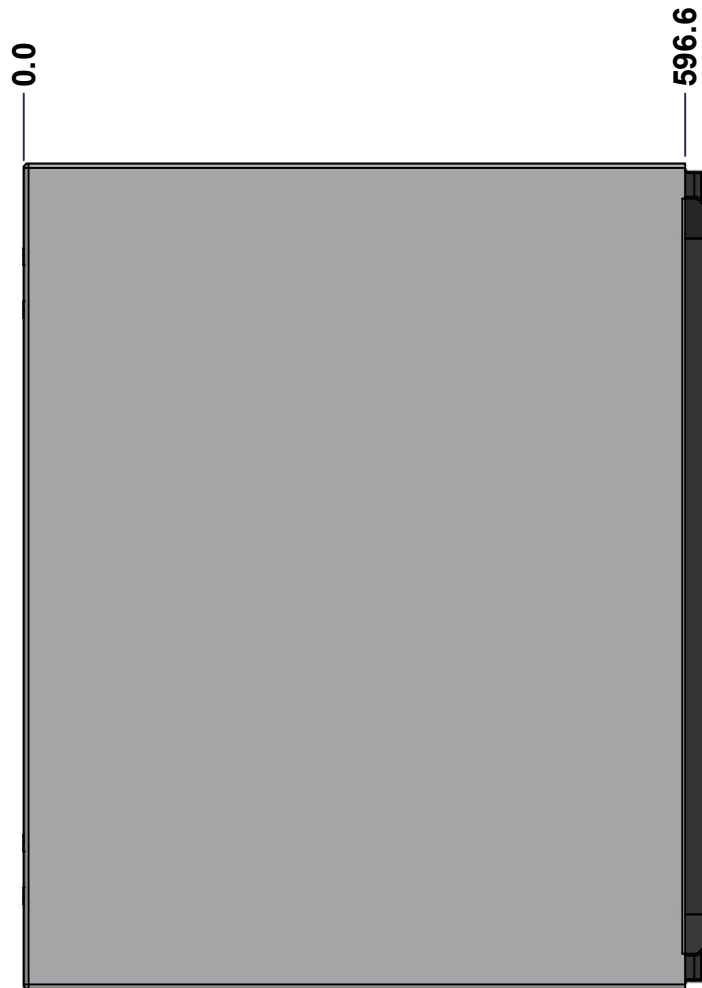

FRONT

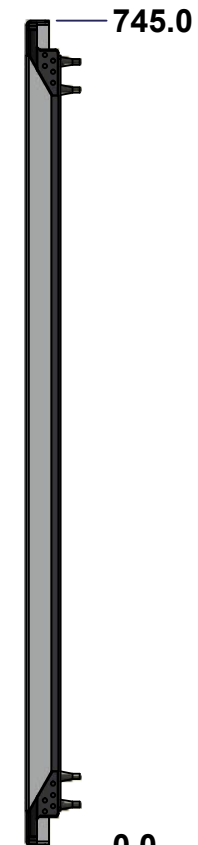

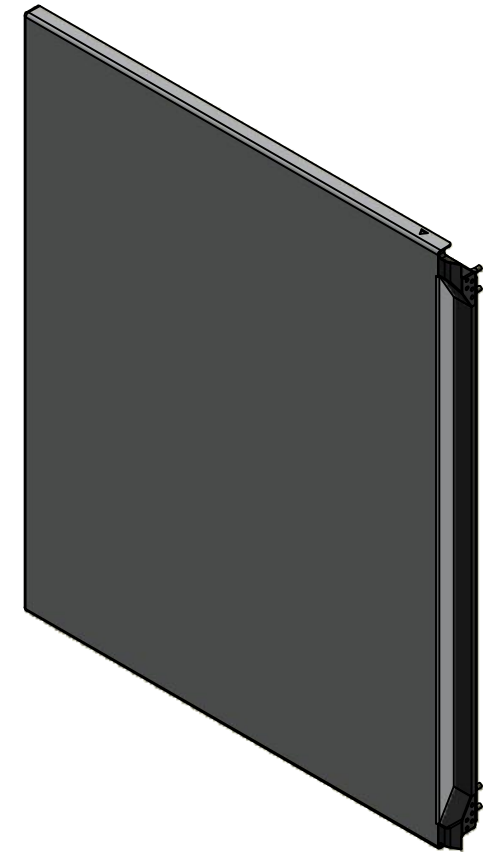

RIGHT



Isometric View

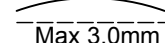

No.	Revisions	Date	By/Par

 Tél: (450) 979-4373 Fax: (450) 979-4626 www.exmweb.com		Flatness Aplatissement  Max 3.0mm Projection 
Customer Client	Date	
Drawn By Dessiné Par	BoxCad: BoxCad	Date 04-Aug-15
Material Matière	14 Ga Cold Rolled A1008 CS Type B (1.7mm)	
Color Couleur	Light Grey RAL7035	Finish Fini Rough Textured
Description	Detail Rev.	
6500MCOODD 770mm x 1200mm Back Flange Door		
Part Number Numéro Pièce	Rev.	15
6500MCOODD1205BL	0	22

SEE BILL OF MATERIAL ON LAST PAGE

This drawing is confidential and must not be reproduced or used without the consent of EXM

Ce dessin est confidentiel et ne doit pas être reproduit ou utilisé sans le consentement de EXM

STANDARD FEATURES ARE NOT LISTED IN THIS HOLE TABLE			
HOLE TABLE - FRONT VIEW (CUSTOM FEATURE ONLY)			
CUT-OUT	XDIM	YDIM	DESCRIPTION
1	40.0	35.0	GND STUD M6 x 16mm (Inside)

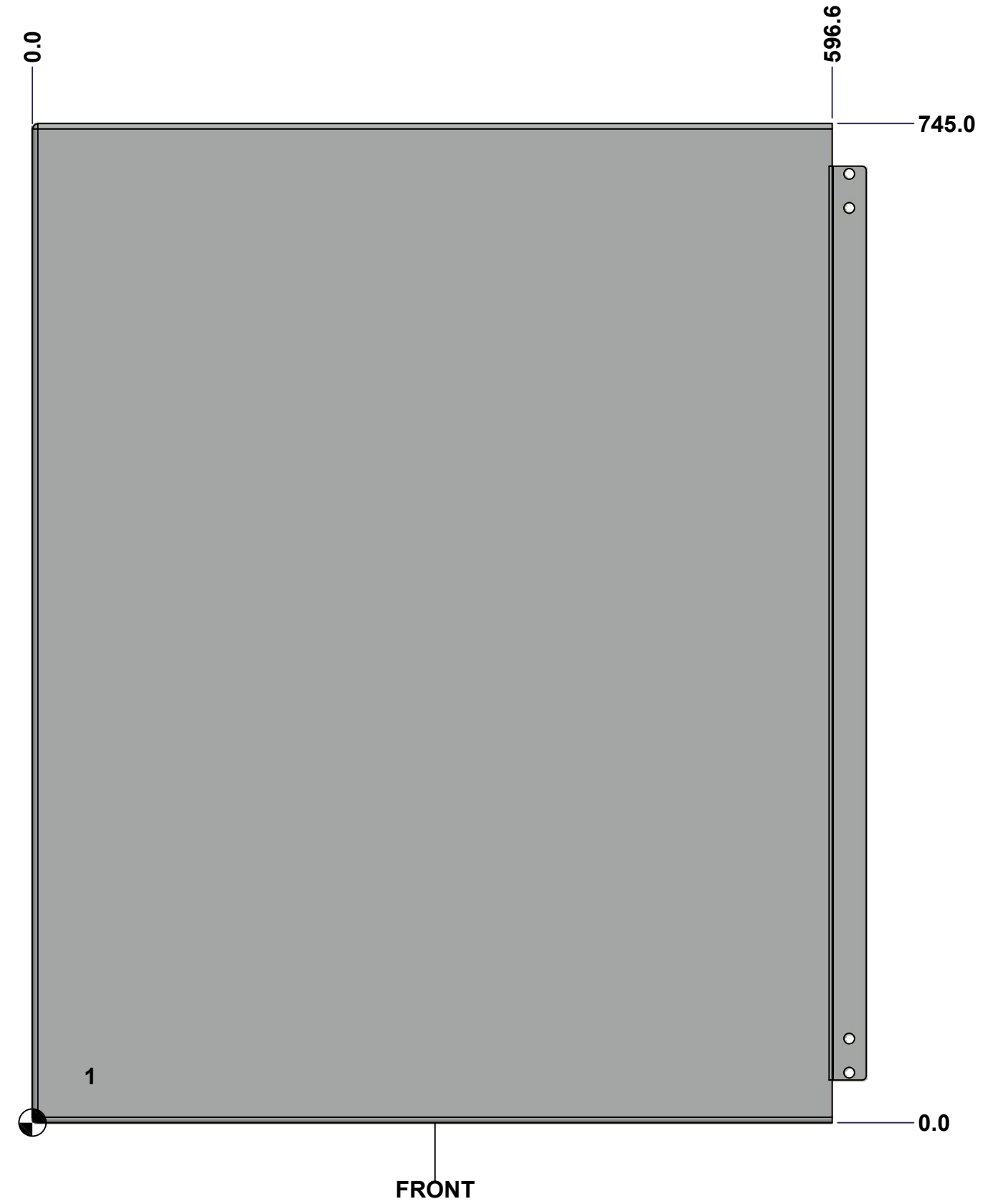

	Description 6500MCOOD 770mm x 1200mm Back Flange Door	Status (NULL)
	Part Number Numéro Pièce 6500MCOOD1205BL	Rev. 16 0 22

This drawing is confidential and must not be reproduced or used without the consent of EXM

Ce dessin est confidentiel et ne doit pas être reproduit ou utilisé sans le consentement de EXM

No.	Revisions	Date	By/Par

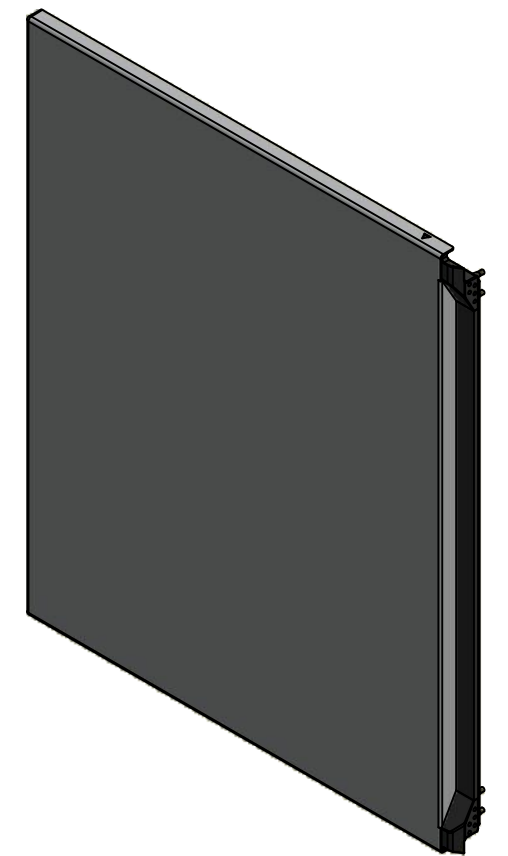

Isometric View



 Tél: (450) 979-4373 Fax: (450) 979-4626 www.exmweb.com	Flatness Aplatissement
	 Max 3.0mm
Projection 	

Customer Client	Date
Drawn By Dessiné Par BoxCad: BoxCad	Date 04-Aug-15

Material Matière	14 Ga Cold Rolled A1008 CS Type B (1.7mm)
---------------------	---

Color Couleur	Light Grey RAL7035	Finish Fini	Rough Textured
------------------	--------------------	----------------	----------------

Description	6500MCODD 770mm x 1200mm Back Flange Door	Detail Rev.
-------------	---	-------------

Part Number Numéro Pièce	6500MCODD1205BL	Rev.	17
		0	22

Qty	Part Number	Rev	Description
1	STK-Q-16080	0	Ground Stud M6 x 16mm
1	STK-P-03820R	0	Powder Paint (Light Grey / Rough Textured)
1	STK-G-03200	6.1	5500 ESDD Lower Flange Door Gasket
1	STK-G-03100	6.1	5500 ESDD Upper Flange Door Gasket
1	STK-G-00701	0	1" x 1/4" Self-Adhesive Neoprene Gasket
1	6500MCODD1205BL-P	0	6500MCODD 770mm x 1200mm Back Flange Door Part
1	6500MCODD1205BL-G	0	6500MCODD 770mm x 1200mm Back Flange Door Gasket
2	STK-K-09800	10	5412 ES Hinge with 2 Captive Hinge Pins
Parts List			

This drawing is confidential and must not be reproduced or used without the consent of EXM

Ce dessin est confidentiel et ne doit pas être reproduit ou utilisé sans le consentement de EXM



TOP

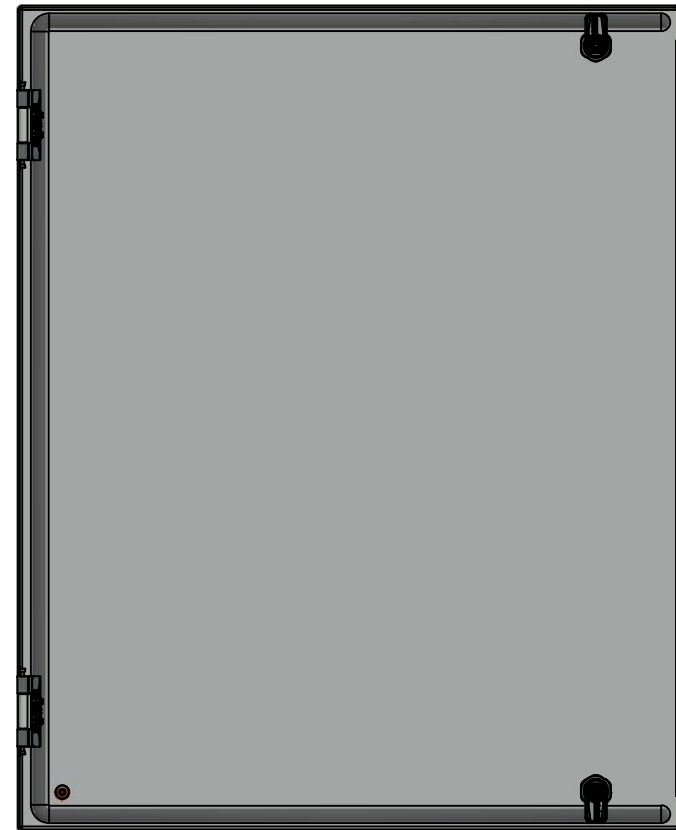

BACK



BOTTOM

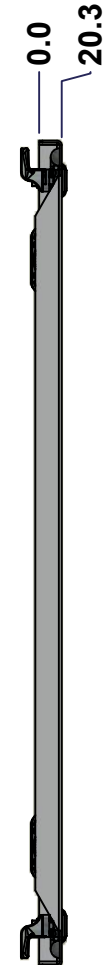

LEFT

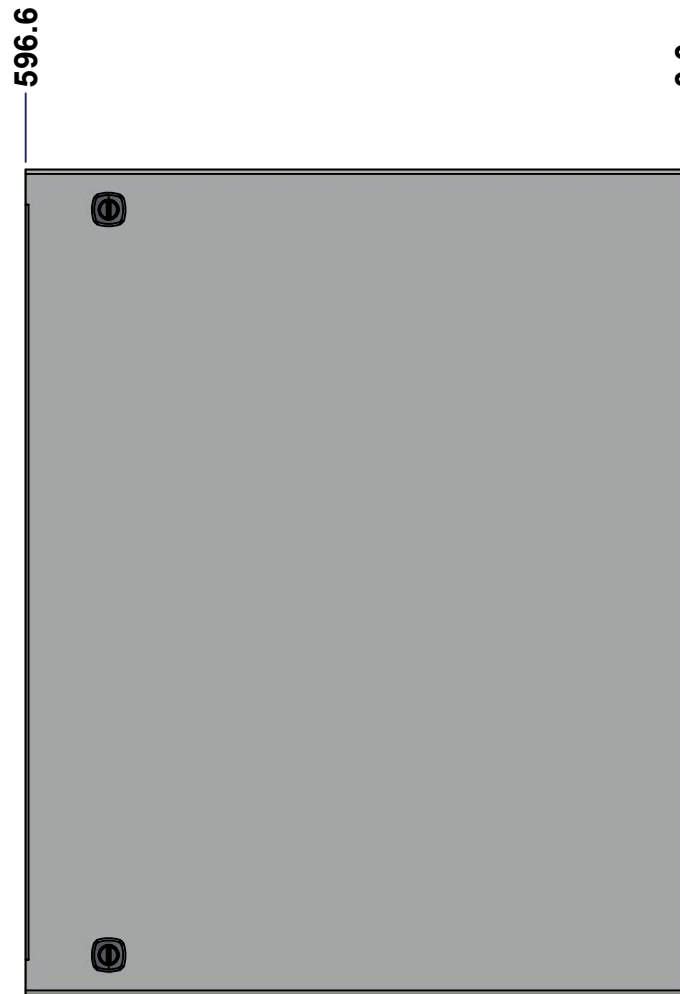

FRONT

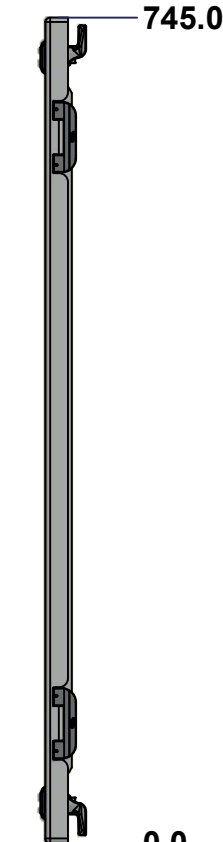

RIGHT

No.	Revisions	Date	By/Par

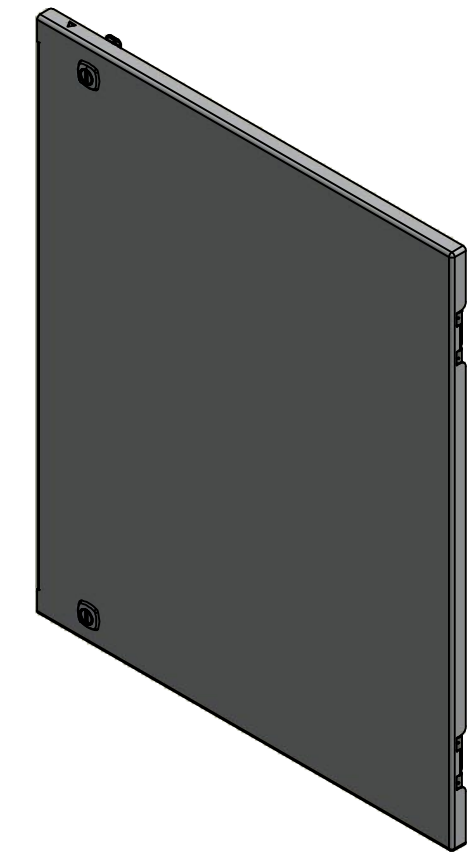

Isometric View

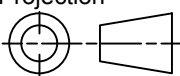

 Tél: (450) 979-4373 Fax: (450) 979-4626 www.exmweb.com		Flatness Aplatissement Max 3.0mm Projection 
Customer Client	Date	
Drawn By Dessiné Par	BoxCad: BoxCad	Date 04-Aug-15
Material Matière	14 Ga Cold Rolled A1008 CS Type B (1.7mm)	
Color Couleur	Light Grey RAL7035	Finish Fini Rough Textured
Description	Detail Rev.	
6500MCOODD 770mm x 1200mm Back Lock Door		
Part Number Numéro Pièce	Rev.	18
6500MCOODD1205BR	0	22

SEE BILL OF MATERIAL ON LAST PAGE

This drawing is confidential and must not be reproduced or used without the consent of EXM

Ce dessin est confidentiel et ne doit pas être reproduit ou utilisé sans le consentement de EXM

STANDARD FEATURES ARE NOT LISTED IN THIS HOLE TABLE			
HOLE TABLE - FRONT VIEW (CUSTOM FEATURE ONLY)			
CUT-OUT	XDIM	YDIM	DESCRIPTION
1	40.0	35.0	GND STUD M6 x 16mm (Inside)
2	521.6	708.8	LOCK 880 SCQ4-SL @ 90.0°
3	521.6	36.2	LOCK 880 SCQ4-SL @ 270.0°

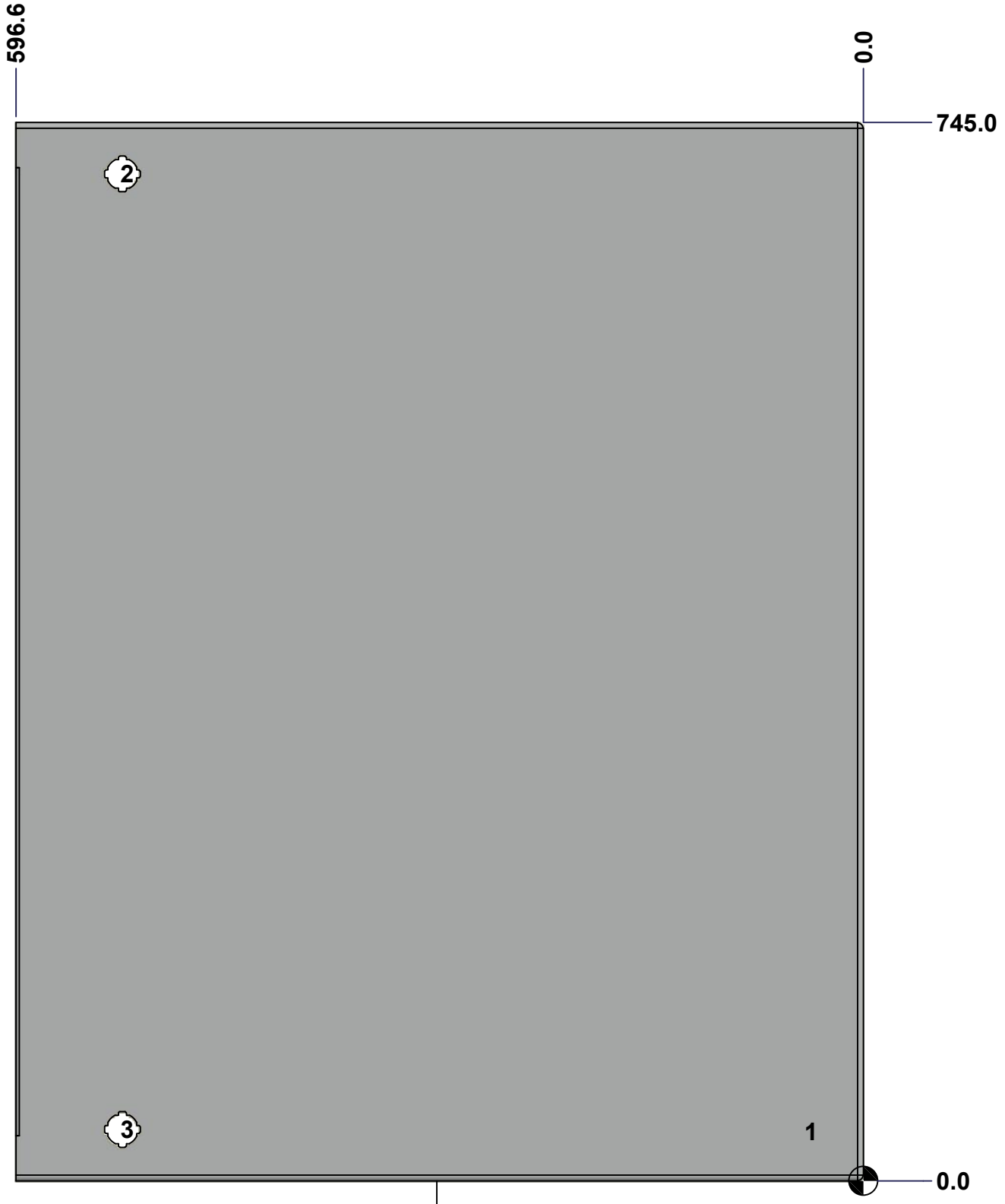

FRONT

	Description 6500MCO DD 770mm x 1200mm Back Lock Door	Status (NULL)
	Part Number Numéro Pièce 6500MCO DD1205BR	Rev. 0 / 19 22

This drawing is confidential and must not be reproduced or used without the consent of EXM

Ce dessin est confidentiel et ne doit pas être reproduit ou utilisé sans le consentement de EXM

No.	Revisions	Date	By/Par

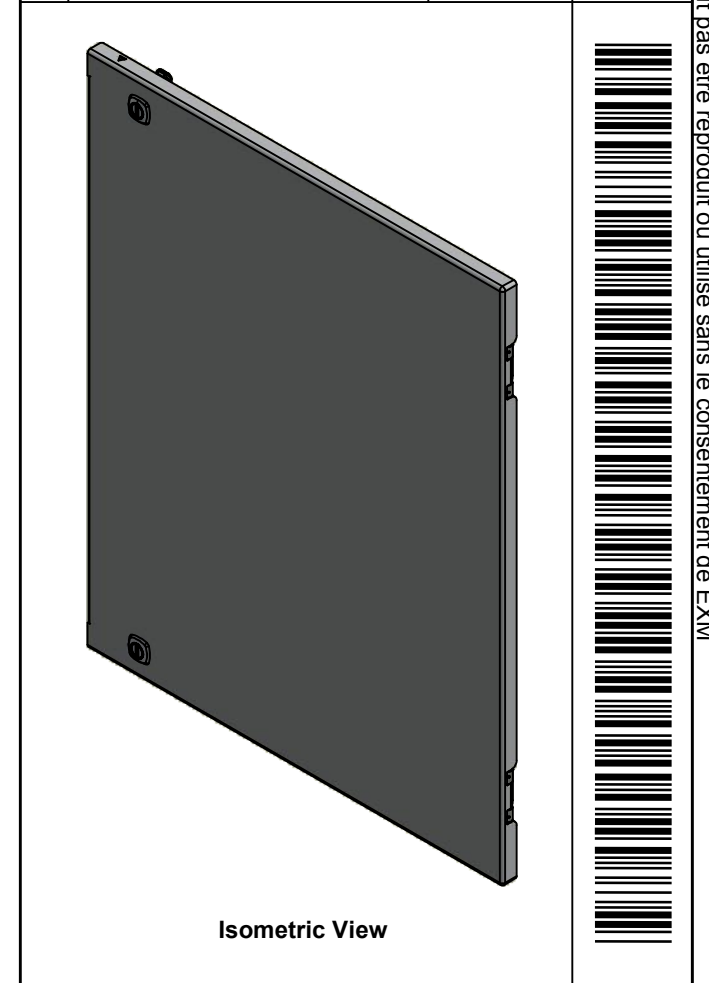

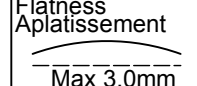
 Tél: (450) 979-4373 Fax: (450) 979-4626 www.exmweb.com		Flatness Aplatissement  Max 3.0mm
Customer Client		Date
Drawn By / Dessiné Par: BoxCad: BoxCad		Date: 04-Aug-15
Material / Matière: 14 Ga Cold Rolled A1008 CS Type B (1.7mm)		
Color / Couleur: Light Grey RAL7035		Finish / Fini: Rough Textured
Description: 6500MCODD 770mm x 1200mm Back Lock Door		Detail Rev.
Part Number / Numéro Pièce: 6500MCODD1205BR		Rev. 0

Qty	Part Number	Rev	Description
1	STK-Q-16080	0	Ground Stud M6 x 16mm
1	STK-P-03820R	0	Powder Paint (Light Grey / Rough Textured)
1	6500MCODD1205BR-P	0	6500MCODD 770mm x 1200mm Back Lock Door Part
1	6500MCODD1205BR-G	0	6500MCODD 770mm x 1200mm Back Lock Door Gasket
2	STK-K-09800	10	5412 ES Hinge with 2 Captive Hinge Pins
2	880 SCQ4-SL	6	5412 ES 1/4 Turn Lock
Parts List			

This drawing is confidential and must not be reproduced or used without the consent of EXM

Ce dessin est confidentiel et ne doit pas être reproduit ou utilisé sans le consentement de EXM



TOP

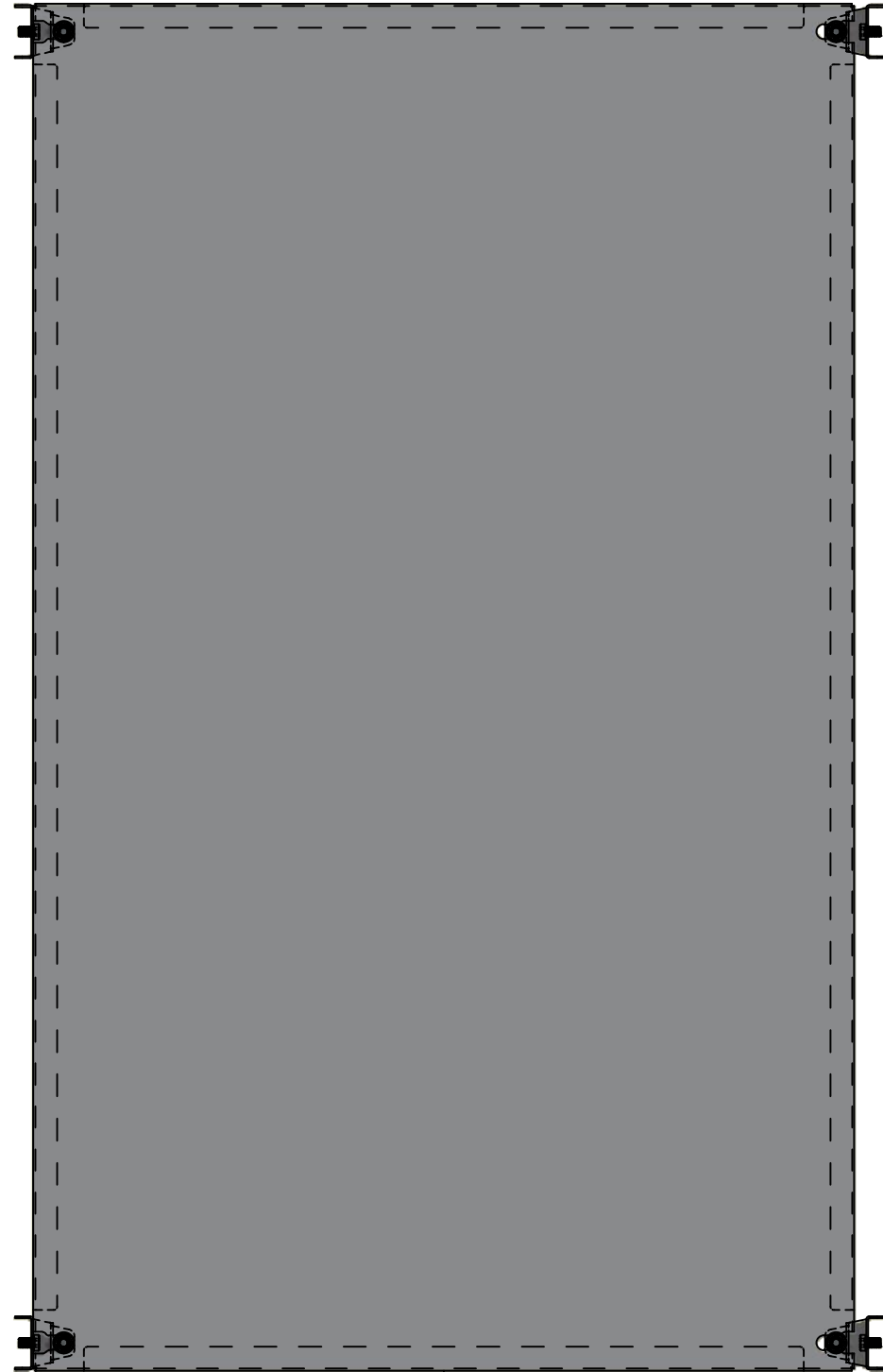

FRONT

1130.0

0.0

RIGHT

SEE BILL OF MATERIAL ON LAST PAGE

No.	Revisions	Date	By/Par

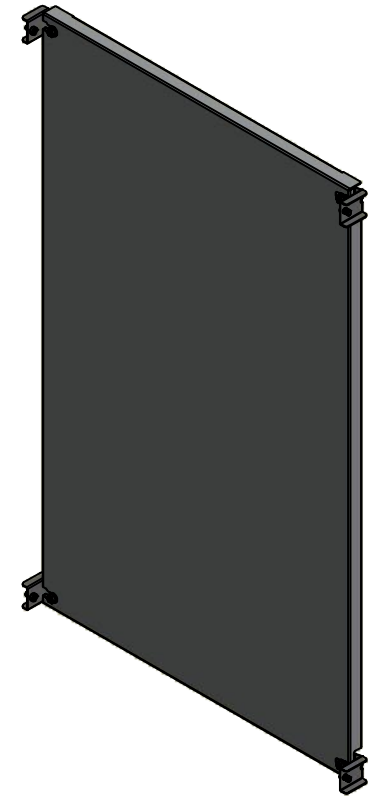

Isometric View



Tél: (450) 979-4373
 Fax: (450) 979-4626
www.exmweb.com

Flatness
Aplatissement

Max 3.0mm

Projection

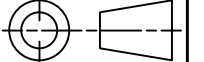

Customer Client	Date
Drawn By / Dessiné Par: BoxCad: BoxCad	Date: 04-Aug-15
Material / Matière: 14 Ga Galvanized	
Color / Couleur: Unpainted	Finish / Fini: Rough Textured
Description: 6500MCODD 770mm x 1200mm Inner Panel Part	Detail Rev.
Part Number / Numéro Pièce: 6500MCODD1205IP	Rev. 0
	21 / 22

This drawing is confidential and must not be reproduced or used without the consent of EXM

Ce dessin est confidentiel et ne doit pas être reproduit ou utilisé sans le consentement de EXM

No.	Revisions	Date	By/Par

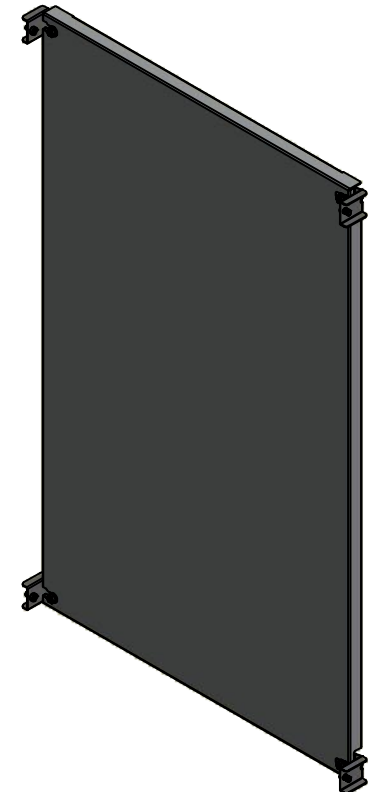

Isometric View



 Tél: (450) 979-4373 Fax: (450) 979-4626 www.exmweb.com		Flatness Aplatissement Max 3.0mm	
Customer Client		Date	
Drawn By Dessiné Par BoxCad: BoxCad		Date 04-Aug-15	
Material Matière 14 Ga Galvanized			
Color Couleur Unpainted		Finish Fini Rough Textured	
Description 6500MCOOD 770mm x 1200mm Inner Panel Part			Detail Rev.
Part Number Numéro Pièce 6500MCOOD1205IP		Rev. 0	22 / 22

Qty	Part Number	Rev	Description
4	STK-Q-00700	2	M8 x 12mm Hex Socket Cap Screw (DIN 6912)
4	STK-Q-07310	2	Flange Lock Nut M8
1	6500MCOOD1205IP-P	0	6500MCOOD 770mm x 1200mm Inner Panel Part
4	STK-Q-07640	0	6500 MTU Inner Panel Support Bracket
Parts List			