

This drawing is confidential and must not be reproduced or used without the consent of EXM

Ce dessin est confidentiel et ne doit pas être reproduit ou utilisé sans le consentement de EXM

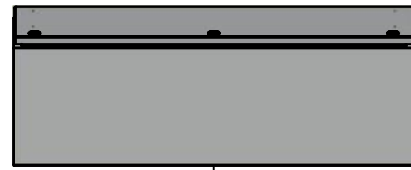

TOP



BACK

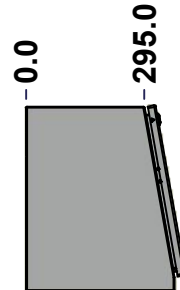

LEFT

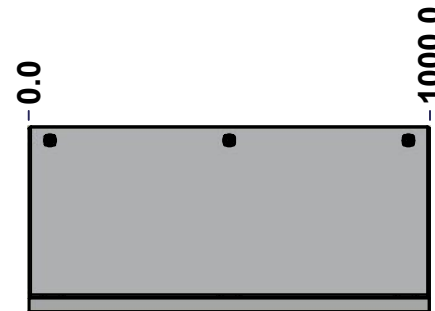

FRONT

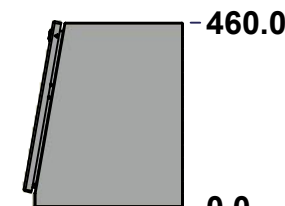

RIGHT

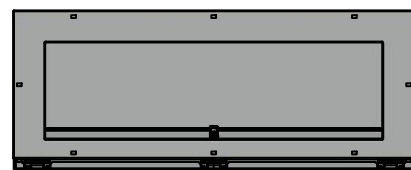

BOTTOM

| No. | Revisions | Date | By/Par |
|-----|-----------|------|--------|
| | | | |
| | | | |
| | | | |
| | | | |

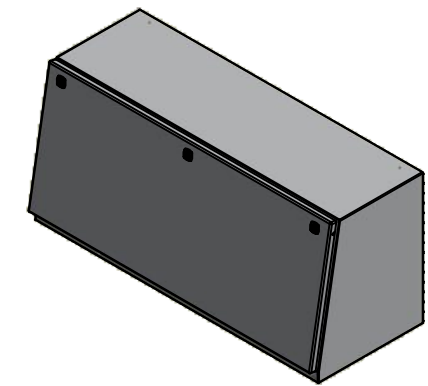

Isometric View



Tél: (450) 979-4373
 Fax: (450) 979-4626
www.exmweb.com

Flatness
Aplatissement
Max 3.0mm
Projection

Customer Client
 Drawn By / Dessiné Par: BoxCad: BoxCad
 Date: 10-Aug-15

Material / Matière: 14 Ga Cold Rolled A1008 CS Type B (1.7mm)

Color / Couleur: Light Grey RAL7035
 Finish / Fini: Rough Textured

Description: 6500MTUFD 460mm x 1000mm x 400mm Assembly
 Detail Rev.

Part Number / Numéro Pièce: **6500MTUFD1004**
 Rev. 0

SEE BILL OF MATERIAL ON LAST PAGE

This drawing is confidential and must not be reproduced or used without the consent of EXM

Ce dessin est confidentiel et ne doit pas être reproduit ou utilisé sans le consentement de EXM

| NOTE | |
|------|--|
| ITEM | DESCRIPTION |
| 1 | NEMA 12/13 Enclosure |
| 2 | C/W Standard ground studs on box and cover |
| 3 | C/W Standard door stiffener |
| 4 | C/W Special inner panel (Sold separately) |
| 5 | C/W Standard inner panel mounting studs |

| No. | Revisions | Date | By/Par |
|-----|-----------|------|--------|
| | | | |
| | | | |
| | | | |
| | | | |
| | | | |

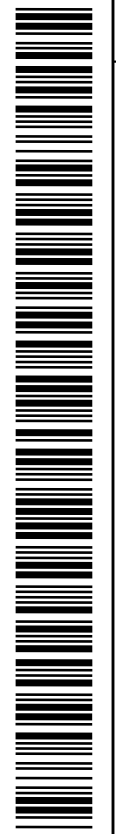
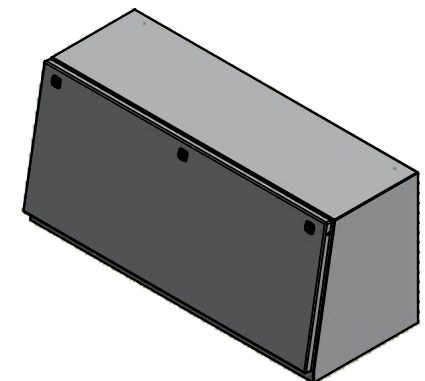

Isometric View



Tél: (450) 979-4373
 Fax: (450) 979-4626
www.exmweb.com

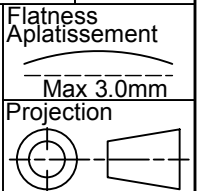

| | |
|--|-----------------|
| Customer Client | Date |
| Drawn By / Dessiné Par: BoxCad: BoxCad | Date: 10-Aug-15 |

Material / Matière: 14 Ga Cold Rolled A1008 CS Type B (1.7mm)

| | |
|-------------------------------------|-------------------------------|
| Color / Couleur: Light Grey RAL7035 | Finish / Fini: Rough Textured |
|-------------------------------------|-------------------------------|

Description: 6500MTUFD 460mm x 1000mm x 400mm Assembly

| | | | |
|--|--------|---|----|
| Part Number / Numéro Pièce: 6500MTUFD1004 | Rev. 0 | 2 | 13 |
|--|--------|---|----|

| PACKING | | |
|----------------------|-----|--|
| ITEM | QTY | DESCRIPTION |
| Cardboard corner | 2 | To reinforced for the plastic strap tightening |
| Honeycomb angle | 4 | To protect each corners |
| Plastic strap- Green | 2 | To secure the enclosure to the wood pallet |
| Wood pallet | 1 | Standard wood pallet |
| Flat cardboard | 1 | Between the enclosure and the wood pallet |
| Packaging label | 1 | White label with product number |

| Qty | Part Number | Rev | Description |
|-----|-----------------|-----|--|
| 1 | 6500MTUFD1004IP | 0 | 6500MTUFD 460mm x 1000mm Inner Panel Part |
| 4 | STK-Q-05025 | 1 | M5 x 9.5mm Thread Rolling Screw |
| 2 | STK-A-GASSPRING | 0 | Gas Spring 115N/12Kg/26Lbs |
| 1 | 6500MTUFD1004FD | 0 | 6500MTUFD 460mm x 1000mm Front Cover |
| 1 | 6500MTUFD1004B | 0 | 6500MTUFD 460mm x 1000mm x 400mm Body |
| 3 | STK-Q-04050-07 | 7 | M6 x 7mm Hexagon Socket Head Machine Screw with Nyseal |
| 4 | STK-Q-08100 | 1 | M5 Nylon Insert Lock Nut |

Parts List

This drawing is confidential and must not be reproduced or used without the consent of EXM

Ce dessin est confidentiel et ne doit pas être reproduit ou utilisé sans le consentement de EXM

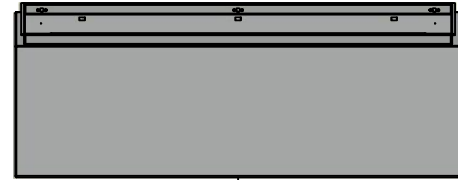

TOP



BACK

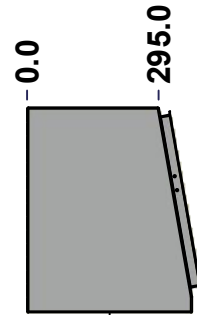

LEFT



FRONT

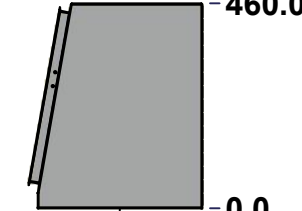

RIGHT

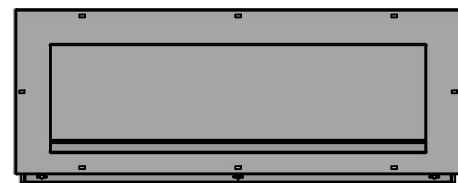

BOTTOM

| No. | Revisions | Date | By/Par |
|-----|-----------|------|--------|
| | | | |
| | | | |
| | | | |
| | | | |

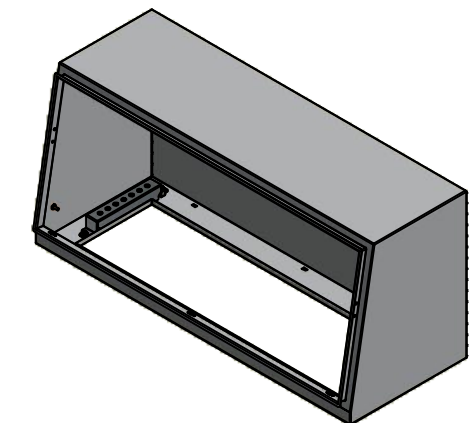

Isometric View



Tél: (450) 979-4373
 Fax: (450) 979-4626
www.exmweb.com

Flatness
Aplatissement

Max 3.0mm

Projection



| | |
|---|-------------------------------|
| Customer Client | Date |
| Drawn By / Dessiné Par: BoxCad: BoxCad | Date: 10-Aug-15 |
| Material / Matière: 14 Ga Cold Rolled A1008 CS Type B (1.7mm) | |
| Color / Couleur: Light Grey RAL7035 | Finish / Fini: Rough Textured |

Description: 6500MTUFD 460mm x 1000mm x 400mm Body

| | | |
|---|--------|---|
| Part Number / Numéro Pièce: 6500MTUFD1004B | Rev. 0 | 3 |
|---|--------|---|

SEE BILL OF MATERIAL ON LAST PAGE

This drawing is confidential and must not be reproduced or used without the consent of EXM

Ce dessin est confidentiel et ne doit pas être reproduit ou utilisé sans le consentement de EXM

STANDARD FEATURES ARE NOT LISTED IN THIS HOLE TABLE

HOLE TABLE - TOP VIEW (CUSTOM FEATURE ONLY)

| CUT-OUT | XDIM | YDIM | DESCRIPTION |
|---------|-------|-------|-------------------------|
| 1 | 58.0 | 25.0 | STUD M6 x 18mm (Inside) |
| 2 | 942.0 | 25.0 | STUD M6 x 18mm (Inside) |
| 3 | 58.0 | 270.0 | STUD M6 x 18mm (Inside) |
| 4 | 942.0 | 270.0 | STUD M6 x 18mm (Inside) |

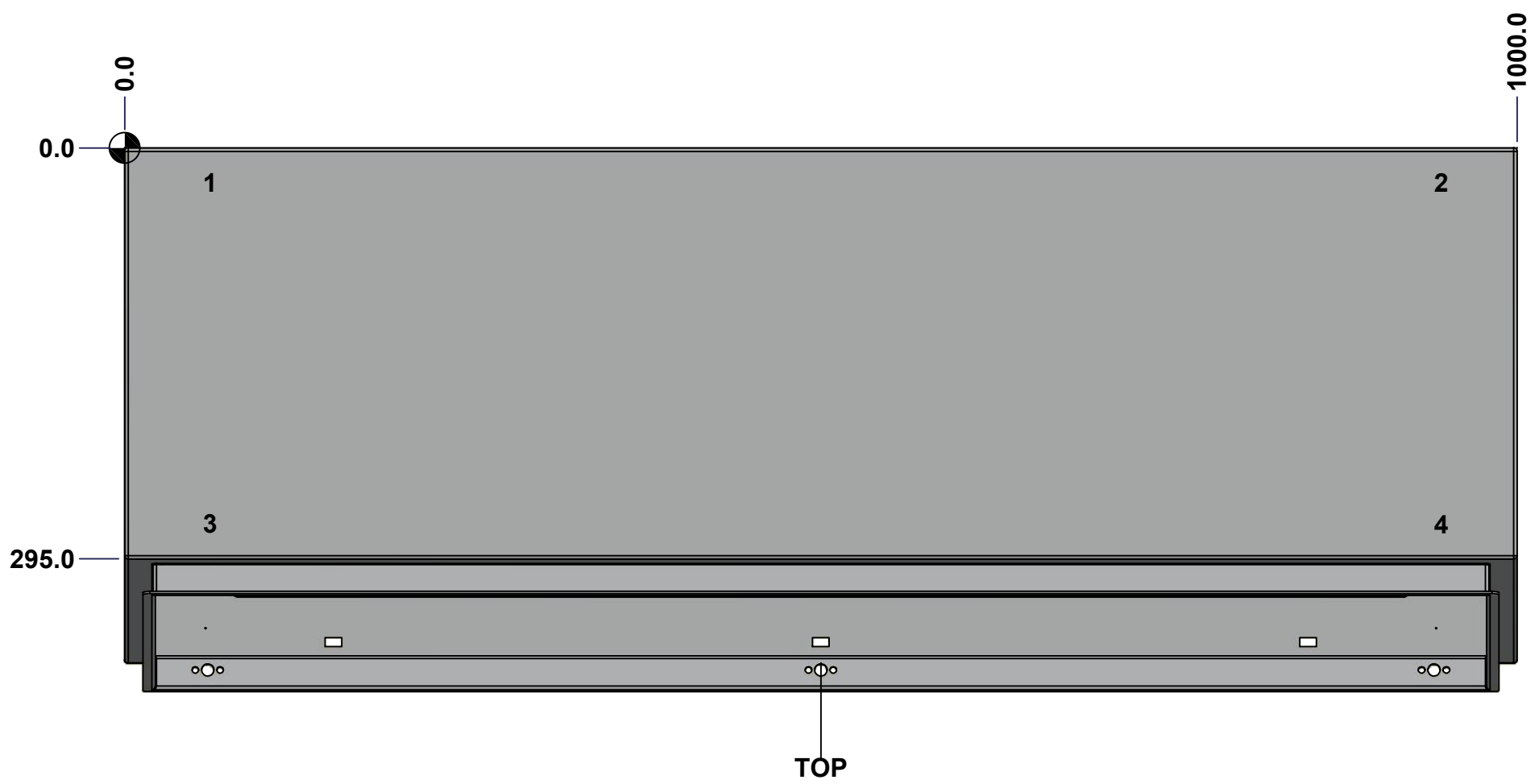

| | | | | |
|--|---|--|------------------|---------|
| | Description 6500MTUFD 460mm x 1000mm x 400mm Body | | Status (NULL) | |
| | Part Number Numéro Pièce 6500MTUFD1004B | | Rev. 0 | 4 13 |

This drawing is confidential and must not be reproduced or used without the consent of EXM

Ce dessin est confidentiel et ne doit pas être reproduit ou utilisé sans le consentement de EXM

| STANDARD FEATURES ARE NOT LISTED IN THIS HOLE TABLE | | | |
|--|-------|------|-----------------------------|
| HOLE TABLE - RIGHT VIEW (CUSTOM FEATURE ONLY) | | | |
| CUT-OUT | XDIM | YDIM | DESCRIPTION |
| 1 | 315.0 | 75.0 | GND STUD M6 x 16mm (Inside) |

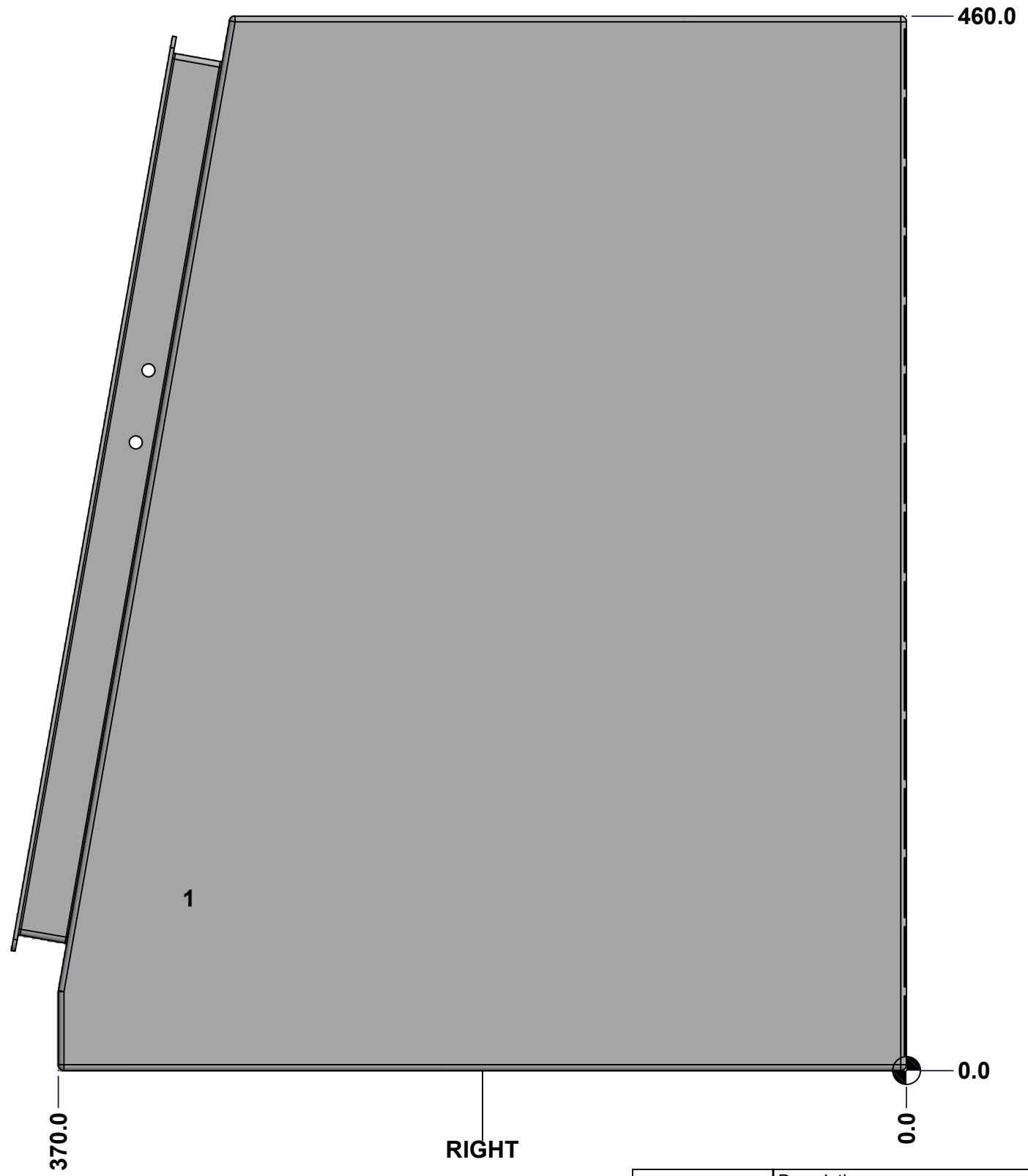

| | | | |
|--|---|--|--------------------|
| | Description 6500MTUFD 460mm x 1000mm x 400mm Body | | Status (NULL) |
| | Part Number Numéro Pièce 6500MTUFD1004B | | Rev. 5 0 |

This drawing is confidential and must not be reproduced or used without the consent of EXM

Ce dessin est confidentiel et ne doit pas être reproduit ou utilisé sans le consentement de EXM

STANDARD FEATURES ARE NOT LISTED IN THIS HOLE TABLE

HOLE TABLE - BOTTOM VIEW (CUSTOM FEATURE ONLY)

| CUT-OUT | XDIM | YDIM | DESCRIPTION |
|---------|-------|-------|-------------------------|
| 1 | 58.0 | 25.0 | STUD M6 x 18mm (Inside) |
| 2 | 942.0 | 25.0 | STUD M6 x 18mm (Inside) |
| 3 | 58.0 | 270.0 | STUD M6 x 18mm (Inside) |
| 4 | 942.0 | 270.0 | STUD M6 x 18mm (Inside) |

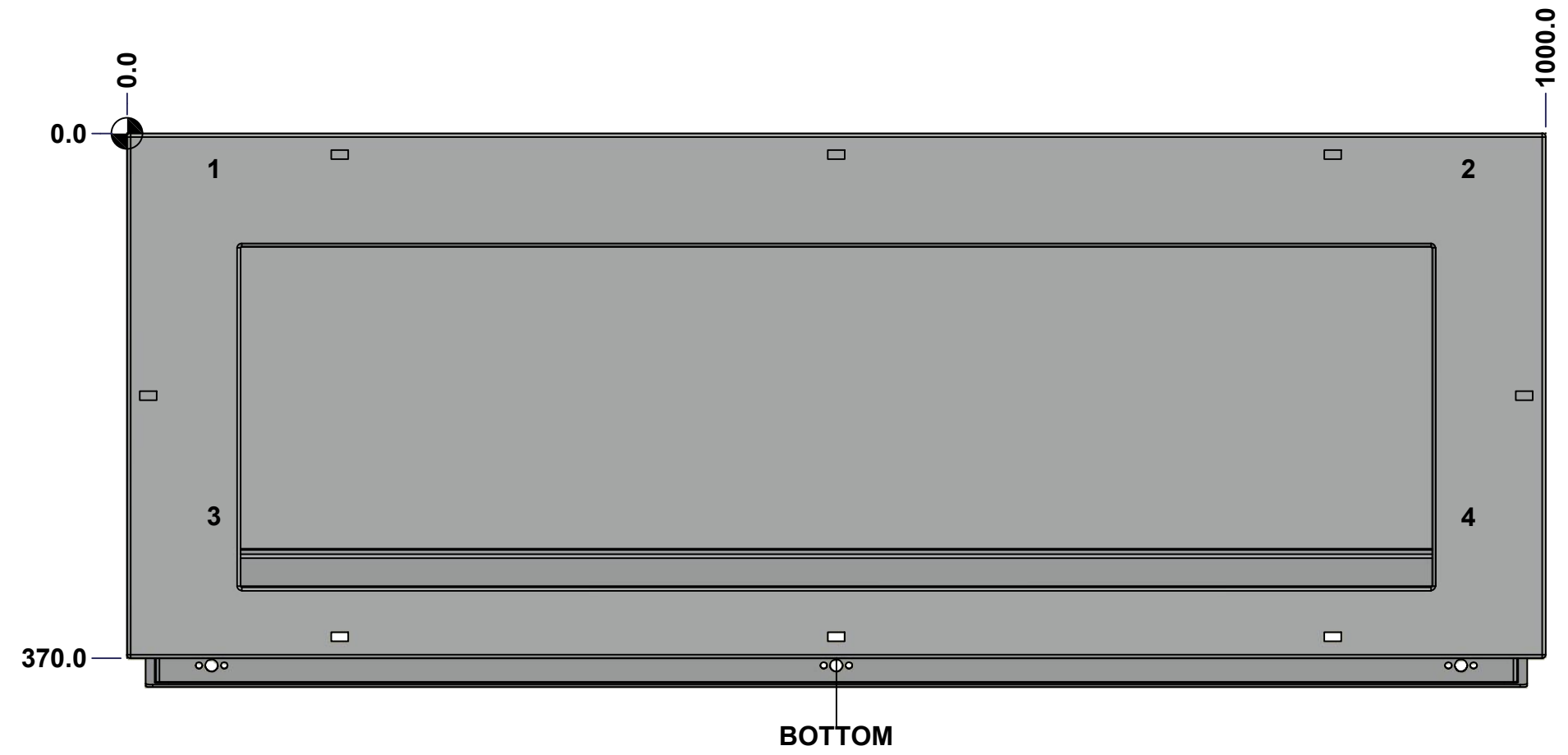

| | | | | |
|--|---|--|------------------|---------|
| | Description 6500MTUFD 460mm x 1000mm x 400mm Body | | Status (NULL) | |
| | Part Number Numéro Pièce 6500MTUFD1004B | | Rev. 0 | 6 13 |

This drawing is confidential and must not be reproduced or used without the consent of EXM

Ce dessin est confidentiel et ne doit pas être reproduit ou utilisé sans le consentement de EXM

STANDARD FEATURES ARE NOT LISTED IN THIS HOLE TABLE

HOLE TABLE - LEFT VIEW (CUSTOM FEATURE ONLY)

| CUT-OUT | XDIM | YDIM | DESCRIPTION |
|---------|-------|------|-----------------------------|
| 1 | 315.0 | 75.0 | GND STUD M6 x 16mm (Inside) |

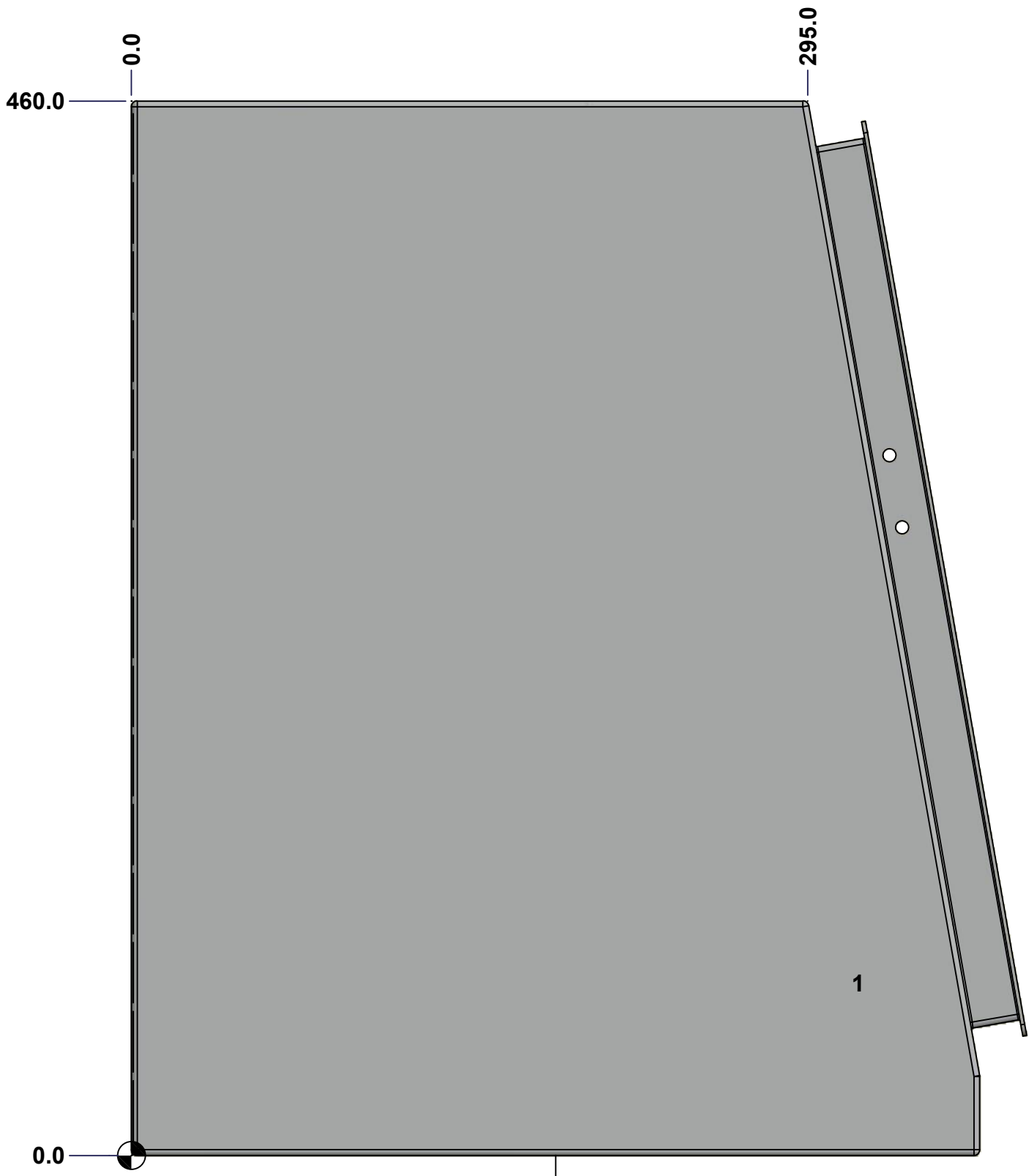

LEFT

| | | | |
|--|---|--|-------------------------|
| | Description 6500MTUFD 460mm x 1000mm x 400mm Body | | Status (NULL) |
| | Part Number Numéro Pièce 6500MTUFD1004B | | Rev. 7 0 / 13 |

This drawing is confidential and must not be reproduced or used without the consent of EXM

Ce dessin est confidentiel et ne doit pas être reproduit ou utilisé sans le consentement de EXM

| No. | Revisions | Date | By/Par |
|-----|-----------|------|--------|
| | | | |
| | | | |
| | | | |
| | | | |
| | | | |

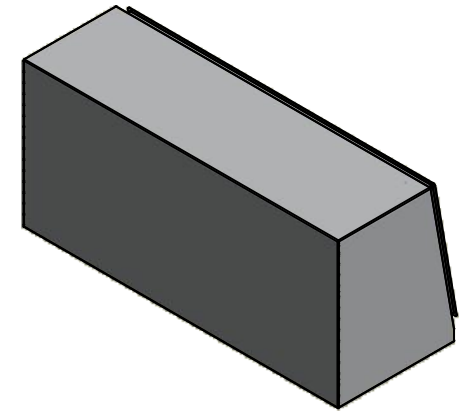

Isometric View

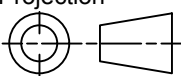

| | | |
|--|---|---|
|  Tél: (450) 979-4373 Fax: (450) 979-4626 www.exmweb.com | Flatness Aplatissement | Max 3.0mm |
| | Projection |  |
| Customer Client | Date | |
| Drawn By Dessiné Par | BoxCad: BoxCad | Date 10-Aug-15 |
| Material Matière | 14 Ga Cold Rolled A1008 CS Type B (1.7mm) | |
| Color Couleur | Light Grey RAL7035 | Finish Fini Rough Textured |
| Description | Detail Rev. | |
| 6500MTUFD 460mm x 1000mm x 400mm Body | 8 | |
| Part Number Numéro Pièce | Rev. 0 | 13 |

| Qty | Part Number | Rev | Description |
|------------|------------------|-----|--|
| 2 | STK-Q-16080 | 0 | Ground Stud M6 x 16mm |
| 1 | STK-P-03820R | 0 | Powder Paint (Light Grey / Rough Textured) |
| 4 | STK-Q-49090-205 | 1 | Mounting Rail 205.0mm |
| 8 | STK-Q-16031 | 0 | M6 x 10mm Stud (No Paint Cap Required) |
| 1 | 6500MTUFD1004B-P | 0 | 6500MTUFD 460mm x 1000mm x 400mm Body Part |
| 8 | STK-Q-07220 | 1 | M6 Nylon Insert Lock Nut |
| Parts List | | | |

This drawing is confidential and must not be reproduced or used without the consent of EXM

Ce dessin est confidentiel et ne doit pas être reproduit ou utilisé sans le consentement de EXM



TOP

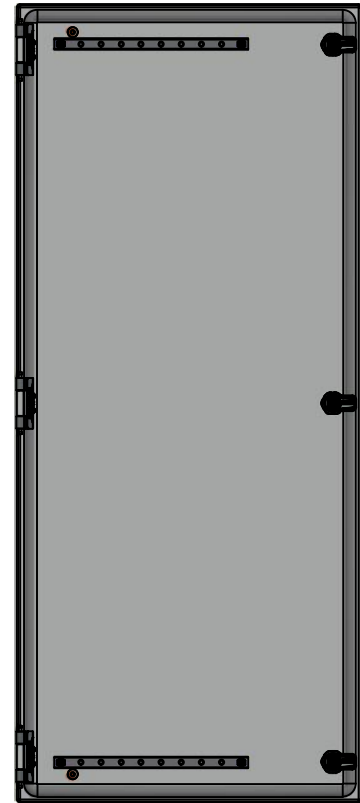

BACK



BOTTOM

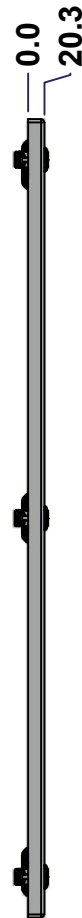

LEFT

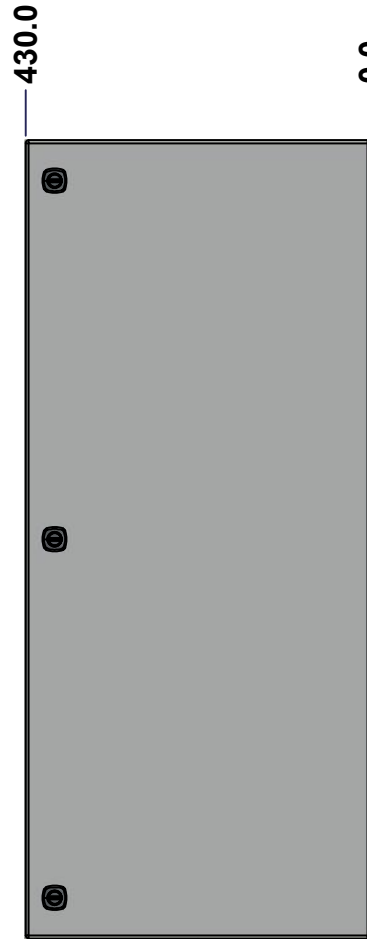

FRONT

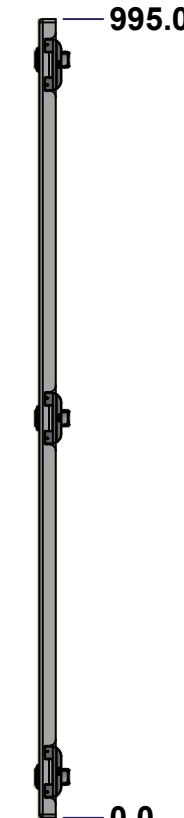

RIGHT

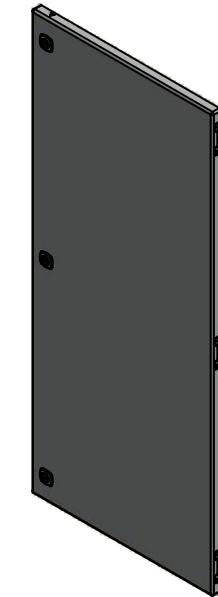

Isometric View

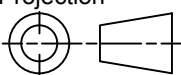

| No. | Revisions | Date | By/Par |
|-----|-----------|------|--------|
| | | | |
| | | | |
| | | | |
| | | | |
| | | | |

| | | |
|--|---|---|
|  Tél: (450) 979-4373 Fax: (450) 979-4626 www.exmweb.com | | Flatness Aplatissement Max 3.0mm Projection  |
| Customer Client | Date | |
| Drawn By Dessiné Par | BoxCad: BoxCad | Date 10-Aug-15 |
| Material Matière | 14 Ga Cold Rolled A1008 CS Type B (1.7mm) | |
| Color Couleur | Light Grey RAL7035 | Finish Fini Rough Textured |
| Description 6500MTUFD 460mm x 1000mm Front Cover | | Detail Rev. |
| Part Number Numéro Pièce | Rev. 0 | 9 13 |

SEE BILL OF MATERIAL ON LAST PAGE

6500MTUFD1004FD

This drawing is confidential and must not be reproduced or used without the consent of EXM

Ce dessin est confidentiel et ne doit pas être reproduit ou utilisé sans le consentement de EXM

STANDARD FEATURES ARE NOT LISTED IN THIS HOLE TABLE

HOLE TABLE - FRONT VIEW (CUSTOM FEATURE ONLY)

| CUT-OUT | XDIM | YDIM | DESCRIPTION |
|---------|-------|-------|-----------------------------|
| 1 | 55.0 | 50.0 | STUD M6 x 18mm (Inside) |
| 2 | 280.0 | 50.0 | STUD M6 x 18mm (Inside) |
| 3 | 55.0 | 945.0 | STUD M6 x 18mm (Inside) |
| 4 | 280.0 | 945.0 | STUD M6 x 18mm (Inside) |
| ----- | | | |
| 5 | 70.0 | 960.0 | GND STUD M6 x 16mm (Inside) |
| 6 | 70.0 | 35.0 | GND STUD M6 x 16mm (Inside) |
| 7 | 393.8 | 50.8 | LOCK 880 SCQ4-SL @ 90.0° |
| 8 | 393.8 | 497.5 | LOCK 880 SCQ4-SL @ 90.0° |
| 9 | 393.8 | 944.2 | LOCK 880 SCQ4-SL @ 90.0° |

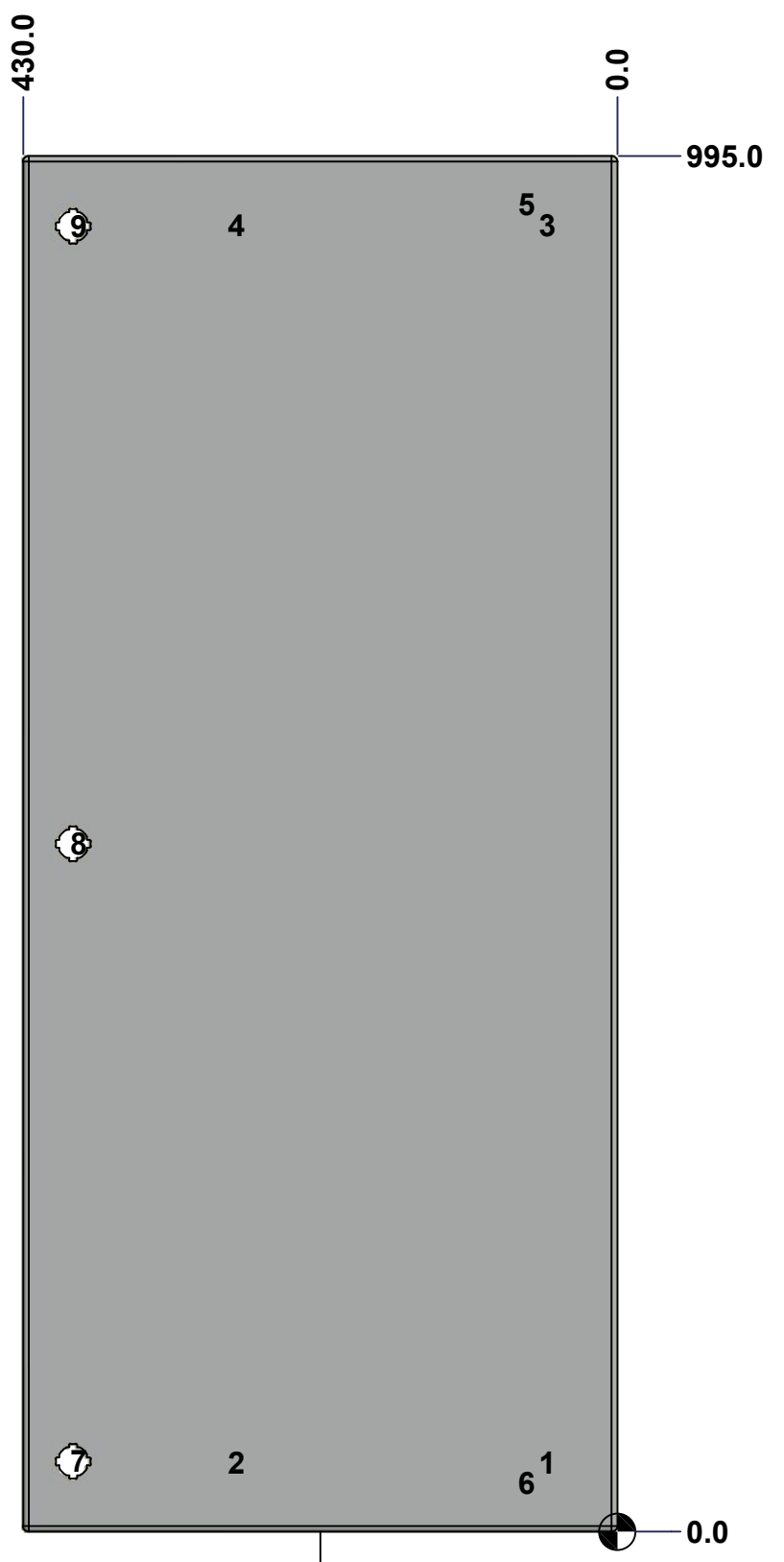

FRONT

| | | | |
|--|---|--|------------------------|
| | Description 6500MTUFD 460mm x 1000mm Front Cover | | Status (NULL) |
| | Part Number Numéro Pièce 6500MTUFD1004FD | | Rev. 10 0 13 |

This drawing is confidential and must not be reproduced or used without the consent of EXM

Ce dessin est confidentiel et ne doit pas être reproduit ou utilisé sans le consentement de EXM

| No. | Revisions | Date | By/Par |
|-----|-----------|------|--------|
| | | | |
| | | | |
| | | | |
| | | | |
| | | | |

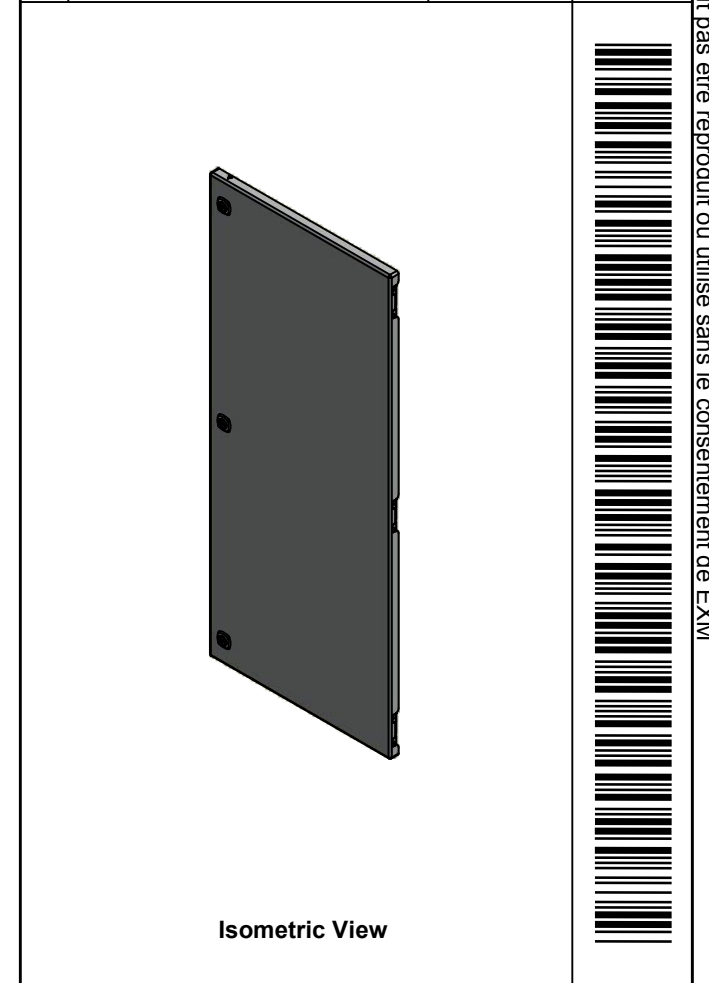

 Tél: (450) 979-4373
 Fax: (450) 979-4626
www.exmweb.com

Flatness / Aplatissement: Max 3.0mm
 Projection: 

| | |
|--|-----------------|
| Customer / Client | Date |
| Drawn By / Dessiné Par: BoxCad: BoxCad | Date: 10-Aug-15 |

| |
|---|
| Material / Matière: 14 Ga Cold Rolled A1008 CS Type B (1.7mm) |
|---|

| | |
|-------------------------------------|-------------------------------|
| Color / Couleur: Light Grey RAL7035 | Finish / Fini: Rough Textured |
|-------------------------------------|-------------------------------|

| | |
|---|-------------|
| Description: 6500MTUFD 460mm x 1000mm Front Cover | Detail Rev. |
|---|-------------|

| | | |
|--|------------------------|---------|
| Part Number / Numéro Pièce: 6500MTUFD1004FD | Rev. / Révis: 0 | 11 / 13 |
|--|------------------------|---------|

| Qty | Part Number | Rev | Description |
|------------|-------------------|-----|---|
| 2 | STK-Q-16080 | 0 | Ground Stud M6 x 16mm |
| 2 | STK-Q-46020-12 | 5 | 5412 ES Vertical Door Stiffener 12" |
| 1 | STK-P-03820R | 0 | Powder Paint (Light Grey / Rough Textured) |
| 4 | STK-Q-16055 | 1 | M6 x 18mm Stud (No Paint Cap Required) |
| 1 | 6500MTUFD1004FD-P | 0 | 6500MTUFD 460mm x 1000mm Front Cover Part |
| 1 | 6500MTUFD1004FD-G | 0 | 6500MTUFD 460mm x 1000mm Front Cover Gasket |
| 3 | STK-K-09800 | 10 | 5412 ES Hinge with 2 Captive Hinge Pins |
| 4 | STK-Q-07220 | 1 | M6 Nylon Insert Lock Nut |
| 3 | 880 SCQ4-SL | 6 | 5412 ES 1/4 Turn Lock |
| Parts List | | | |

This drawing is confidential and must not be reproduced or used without the consent of EXM

Ce dessin est confidentiel et ne doit pas être reproduit ou utilisé sans le consentement de EXM

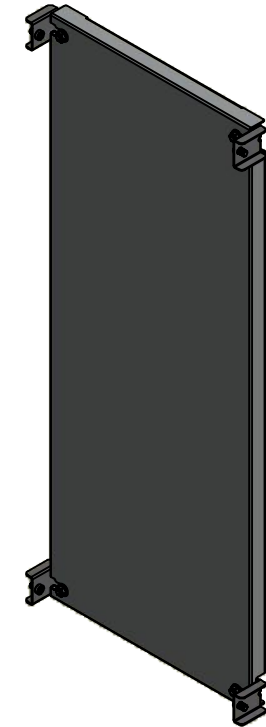
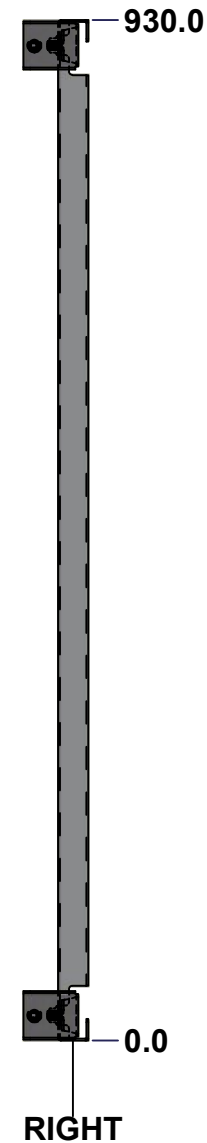
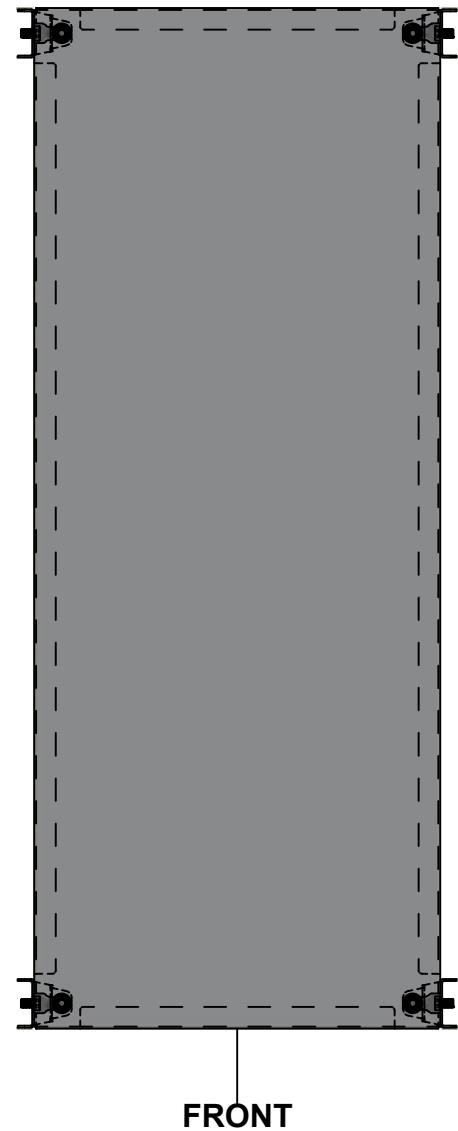
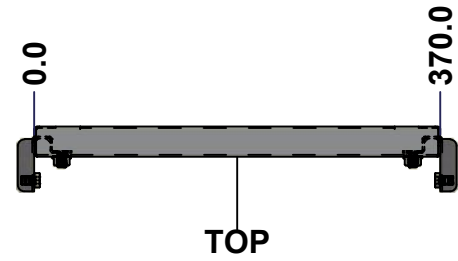

| No. | Revisions | Date | By/Par |
|-----|-----------|------|--------|
| | | | |
| | | | |
| | | | |
| | | | |
| | | | |

Isometric View

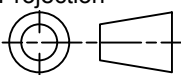
| | | |
|--|------------------|---|
|  Tél: (450) 979-4373 Fax: (450) 979-4626 www.exmweb.com | | Flatness Aplatissement Max 3.0mm Projection  |
| Customer Client | Date | |
| Drawn By Dessiné Par | BoxCad: BoxCad | Date 10-Aug-15 |
| Material Matière | 14 Ga Galvanized | |
| Color Couleur | Unpainted | Finish Fini Rough Textured |
| Description 6500MTUFD 460mm x 1000mm Inner Panel Part | | Detail Rev. |
| Part Number Numéro Pièce | Rev. 0 | 12 13 |

SEE BILL OF MATERIAL ON LAST PAGE

6500MTUFD1004IP

This drawing is confidential and must not be reproduced or used without the consent of EXM

Ce dessin est confidentiel et ne doit pas être reproduit ou utilisé sans le consentement de EXM

| No. | Revisions | Date | By/Par |
|-----|-----------|------|--------|
| | | | |
| | | | |
| | | | |
| | | | |
| | | | |

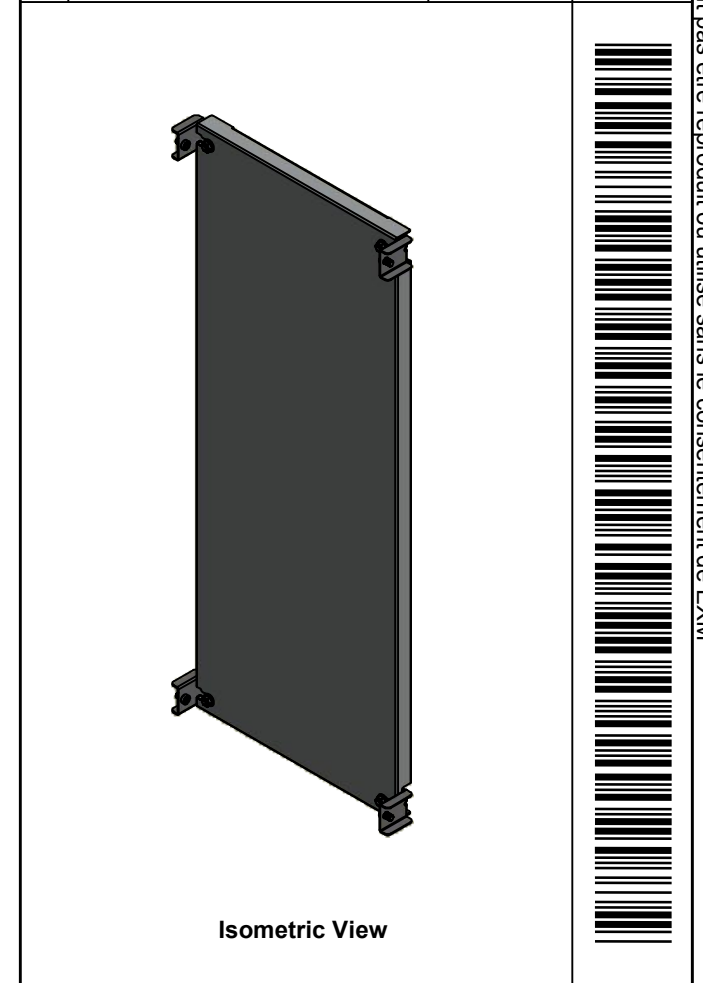

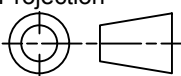
| | | |
|--|------------------|---|
|  Tél: (450) 979-4373 Fax: (450) 979-4626 www.exmweb.com | | Flatness Aplatissement Max 3.0mm Projection  |
| Customer Client | Date | |
| Drawn By Dessiné Par | BoxCad: BoxCad | Date 10-Aug-15 |
| Material Matière | 14 Ga Galvanized | |
| Color Couleur | Unpainted | Finish Fini Rough Textured |
| Description | | Detail Rev. |
| 6500MTUFD 460mm x 1000mm Inner Panel Part | | |
| Part Number Numéro Pièce | Rev. | 13 |
| 6500MTUFD1004IP | 0 | 13 |

| Qty | Part Number | Rev | Description |
|------------|-------------------|-----|---|
| 4 | STK-Q-00700 | 2 | M8 x 12mm Hex Socket Cap Screw (DIN 6912) |
| 4 | STK-Q-07310 | 2 | Flange Lock Nut M8 |
| 1 | 6500MTUFD1004IP-P | 0 | 6500MTUFD 460mm x 1000mm Inner Panel Part |
| 4 | STK-Q-07640 | 0 | 6500 MTU Inner Panel Support Bracket |
| Parts List | | | |