

This drawing is confidential and must not be reproduced or used without the consent of EXM

Ce dessin est confidentiel et ne doit pas être reproduit ou utilisé sans le consentement de EXM

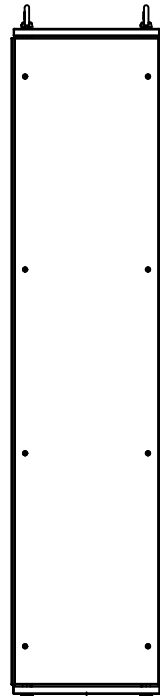

TOP



BACK

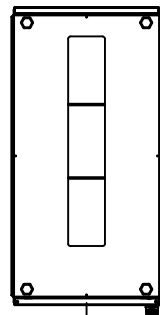

BOTTOM

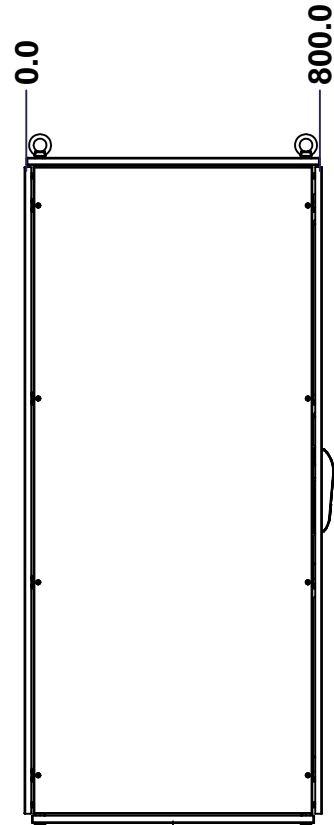

LEFT

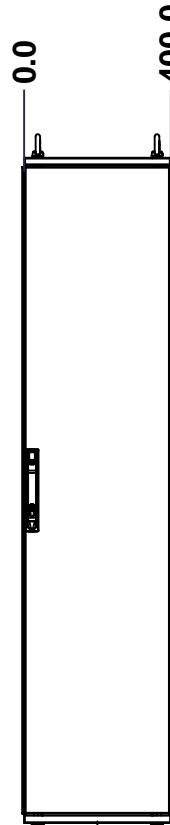

FRONT

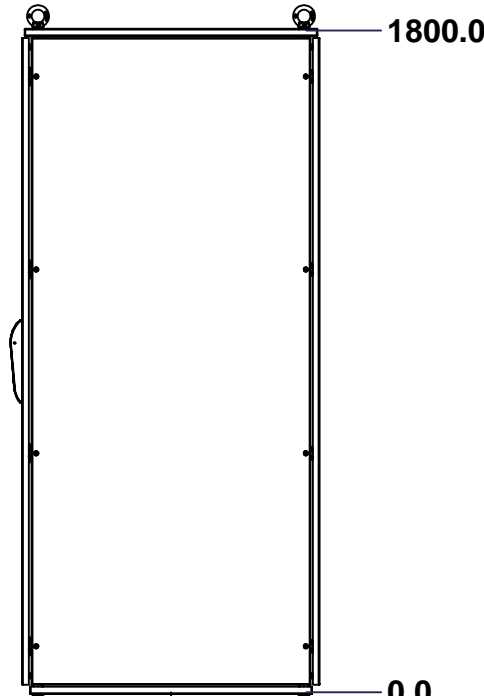

RIGHT

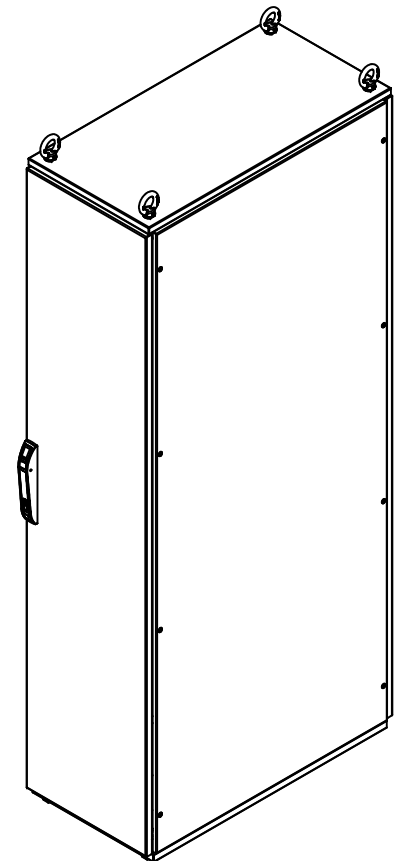

Isometric View

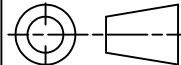

No.	Revisions	Date	By/Par

 Tél: (450) 979-4373 Fax: (450) 979-4626 www.exmweb.com		Flatness Aplatissement Max 3.0mm Projection 
Customer Client	Date	Date
Drawn By Dessiné Par	BoxCad: Annie	Date 09/02/2015
Material Matière	See Part List	
Color Couleur	See Part List	Finish Fini See Part List
Description 6500MX 1800mm x 400mm x 800mm Assembly	Detail Rev.	
Part Number Numéro Pièce	Rev. 0	1 2

SEE BILL OF MATERIAL ON LAST PAGE

6500MXK180408

This drawing is confidential and must not be reproduced or used without the consent of EXM

Ce dessin est confidentiel et ne doit pas être reproduit ou utilisé sans le consentement de EXM

No.	Revisions	Date	By/Par

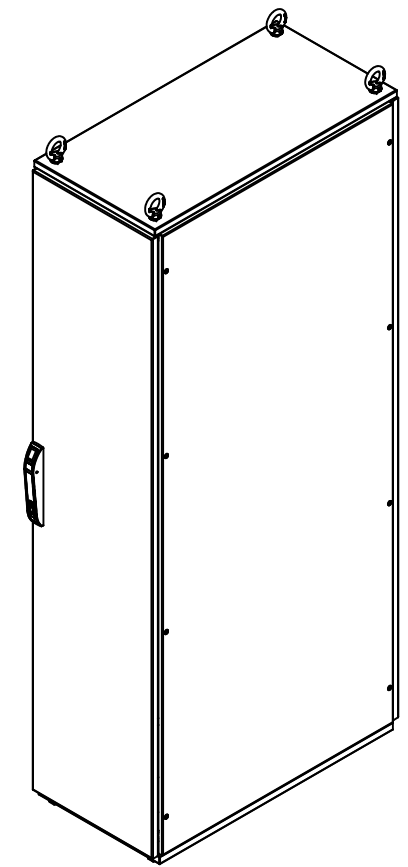

Isometric View



Tél: (450) 979-4373
 Fax: (450) 979-4626
www.exmweb.com

Flatness
Aplatissement
Max 3.0mm
Projection

Customer Client
 Drawn By Dessiné Par BoxCad: Annie
 Date 09/02/2015

Material Matière See Part List

Color Couleur See Part List
 Finish Fini See Part List

Description 6500MX 1800mm x 400mm x 800mm Assembly
 Detail Rev.

Part Number Numéro Pièce **6500MXK180408**
 Rev. 0

1	6500MXK180408BIP	0	6500 MXM 1800mm x 400mm Back Inner Panel
1	6500MXK180408R	0	6500 MXC 1800mm x 800mm Right
1	6500MXK180408L	0	6500 MXC 1800mm x 800mm Left
1	6500MXK180408F	0	6500 MXD 1800mm x 400mm Front
1	6500MXK180408B	0	6500 MXR 1800mm x 400mm Back
1	6500MXK180408BT	0	6500 MXB 400mm x 800mm Bottom
1	6500MXK180408T	0	6500 MXT 400mm x 800mm Top
1	6500MXK180408FR	0	6500 MX 1800mm x 400mm x 800mm Frame
Qty	Part Number	Rev	Description
Parts List			

2
2

This drawing is confidential and must not be reproduced or used without the consent of EXM

Ce dessin est confidentiel et ne doit pas être reproduit ou utilisé sans le consentement de EXM



TOP

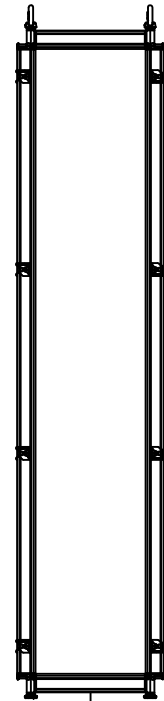

BACK

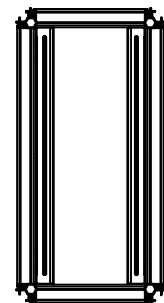

BOTTOM

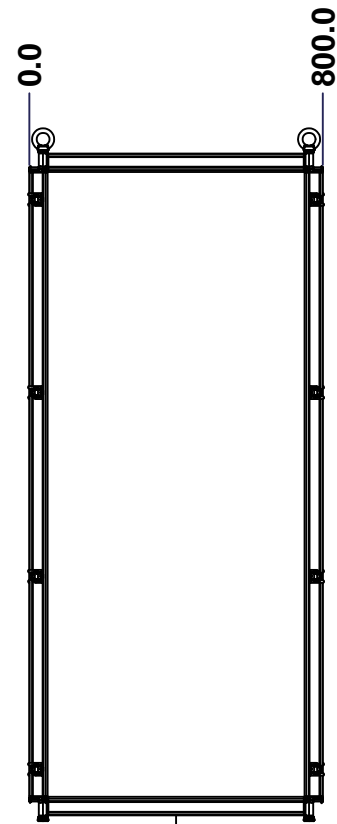

LEFT

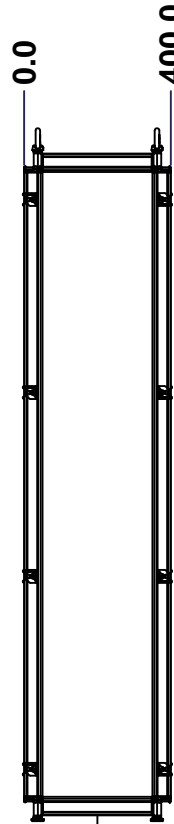

FRONT

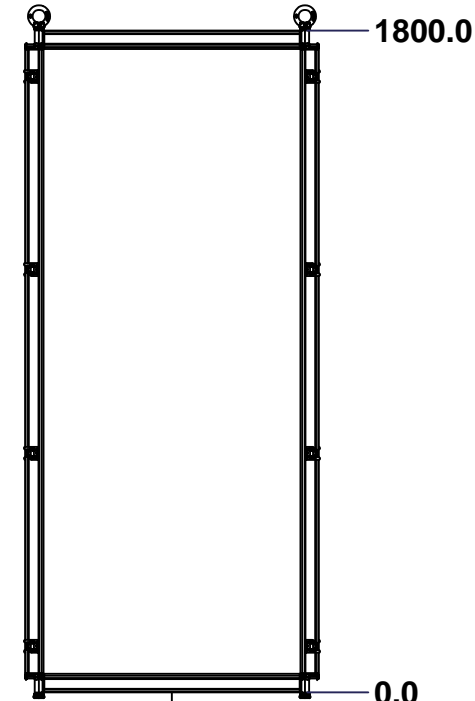

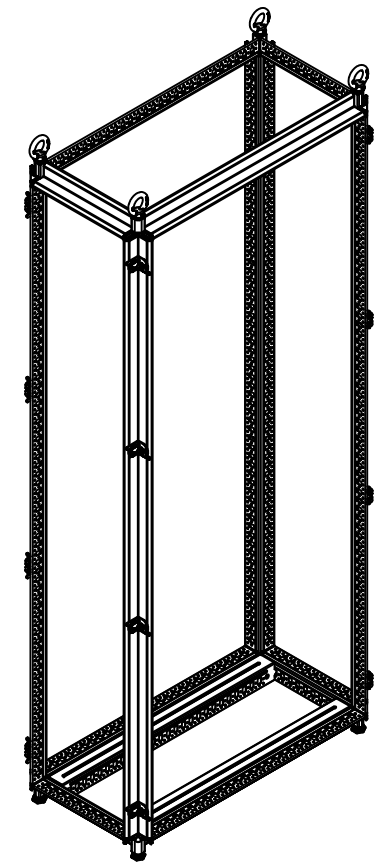

RIGHT



Isometric View

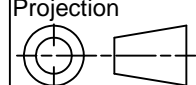

No.	Revisions	Date	By/Par

 Tél: (450) 979-4373 Fax: (450) 979-4626 www.exmweb.com		Flatness Aplatissement  Max 3.0mm Projection 
Customer Client	Date	
Drawn By Dessiné Par	BoxCad: Annie	Date 09/02/2015
Material Matière	16 Ga Electro-Galvanized (1.4mm)	
Color Couleur	Iron Grey RAL7011	Finish Fin Rough Textured
Description	Detail Rev.	
6500 MX 1800mm x 400mm x 800mm Frame		
Part Number Numéro Pièce	Rev.	1 2
6500MXK180408FR	0	

SEE BILL OF MATERIAL ON LAST PAGE

This drawing is confidential and must not be reproduced or used without the consent of EXM

Ce dessin est confidentiel et ne doit pas être reproduit ou utilisé sans le consentement de EXM

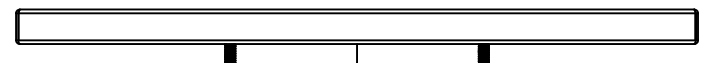

TOP

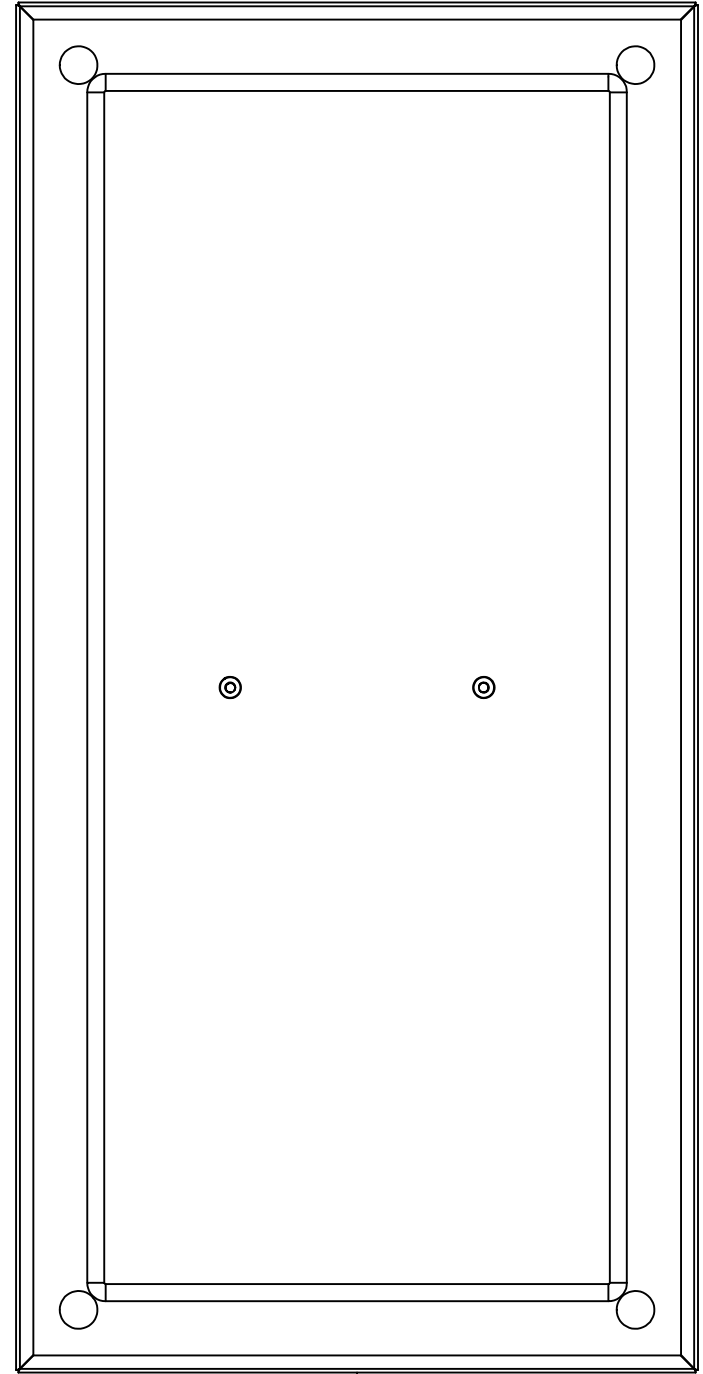

0.0
20.0



LEFT

0.0

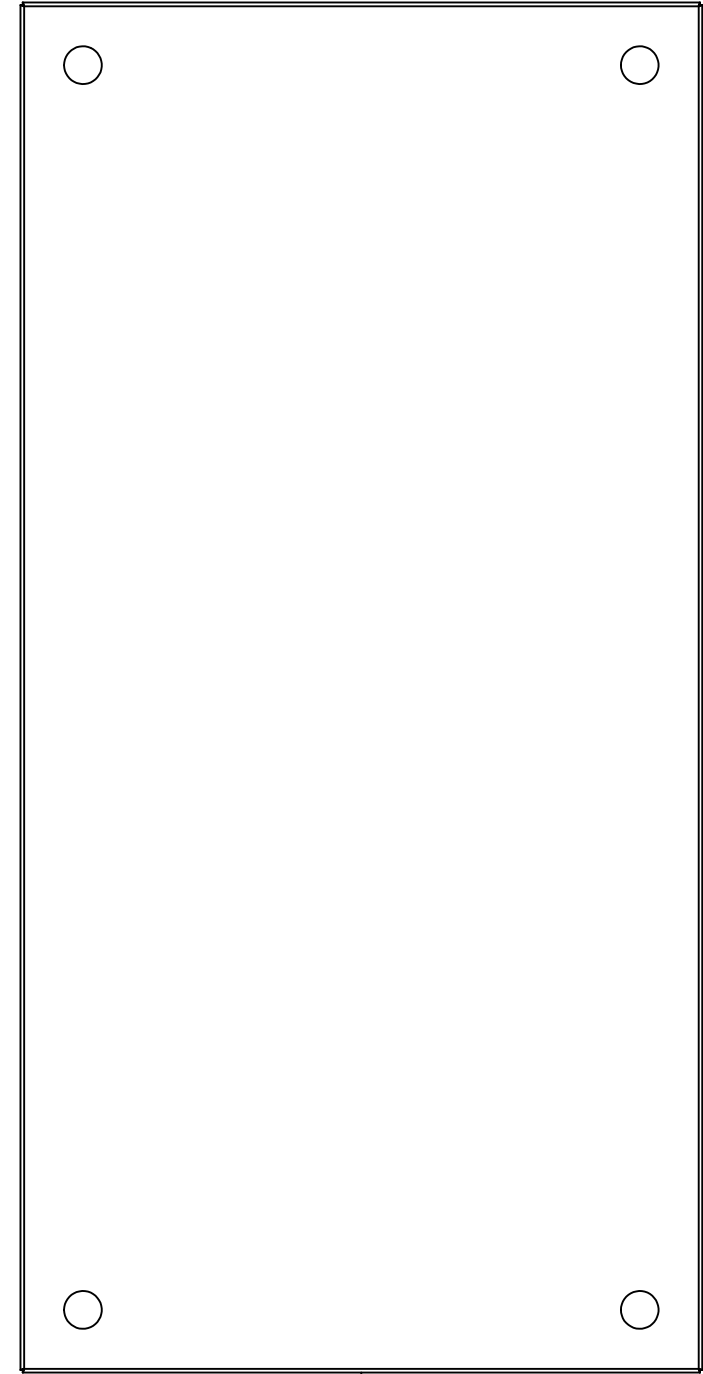

FRONT

398.0

798.0



RIGHT

0.0



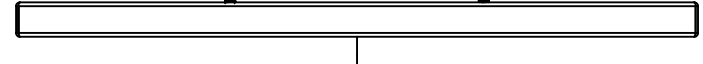

BACK

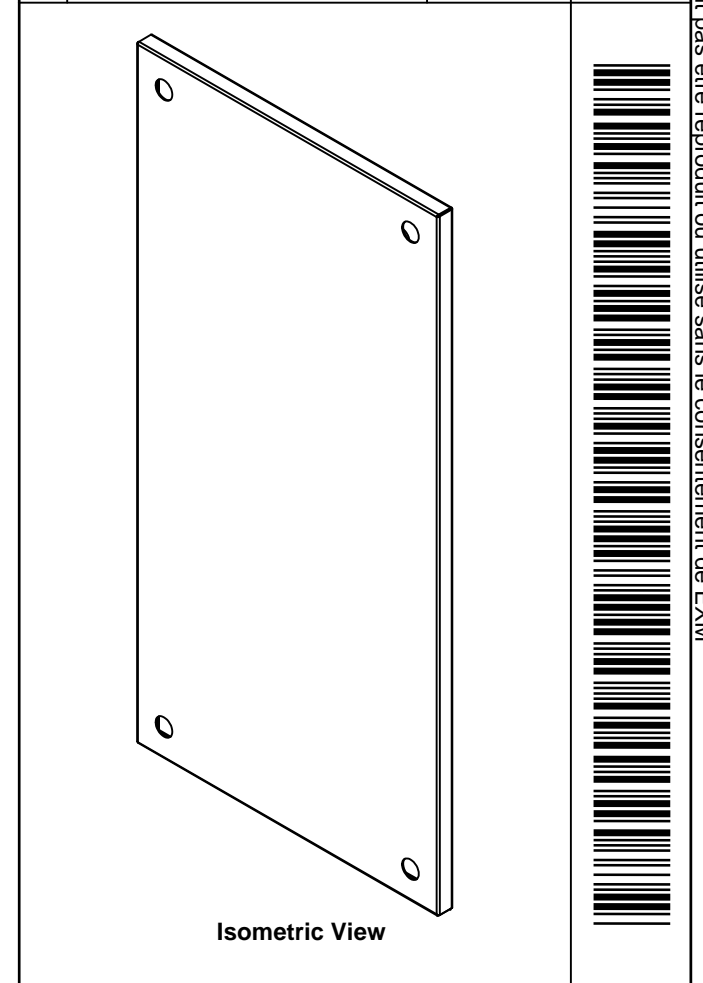

BOTTOM

No.	Revisions	Date	By/Par

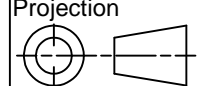

 Tél: (450) 979-4373 Fax: (450) 979-4626 www.exmweb.com		Flatness Aplatissement	
		Max 3.0mm	
Customer Client		Projection	
Date			
Drawn By Dessiné Par		Date	
BoxCad: Annie		09/02/2015	
Material Matière		16 Ga H.R.P. & O. (1.4mm)	
Color Couleur		Finish Fini	
Iron Grey RAL7011		Rough Textured	
Description		Detail Rev.	
6500 MXT 400mm x 800mm Top			
Part Number Numéro Pièce		Rev.	
6500MXK180408T		1 0	

SEE BILL OF MATERIAL ON LAST PAGE

This drawing is confidential and must not be reproduced or used without the consent of EXM

Ce dessin est confidentiel et ne doit pas être reproduit ou utilisé sans le consentement de EXM

STANDARD FEATURES ARE NOT LISTED IN THIS HOLE TABLE			
HOLE TABLE - FRONT VIEW (CUSTOM FEATURE ONLY)			
CUT-OUT	XDIM	YDIM	DESCRIPTION
1	125.0	399.0	GND STUD M6 x 16mm (Inside)
2	273.0	399.0	GND STUD M6 x 16mm (Inside)

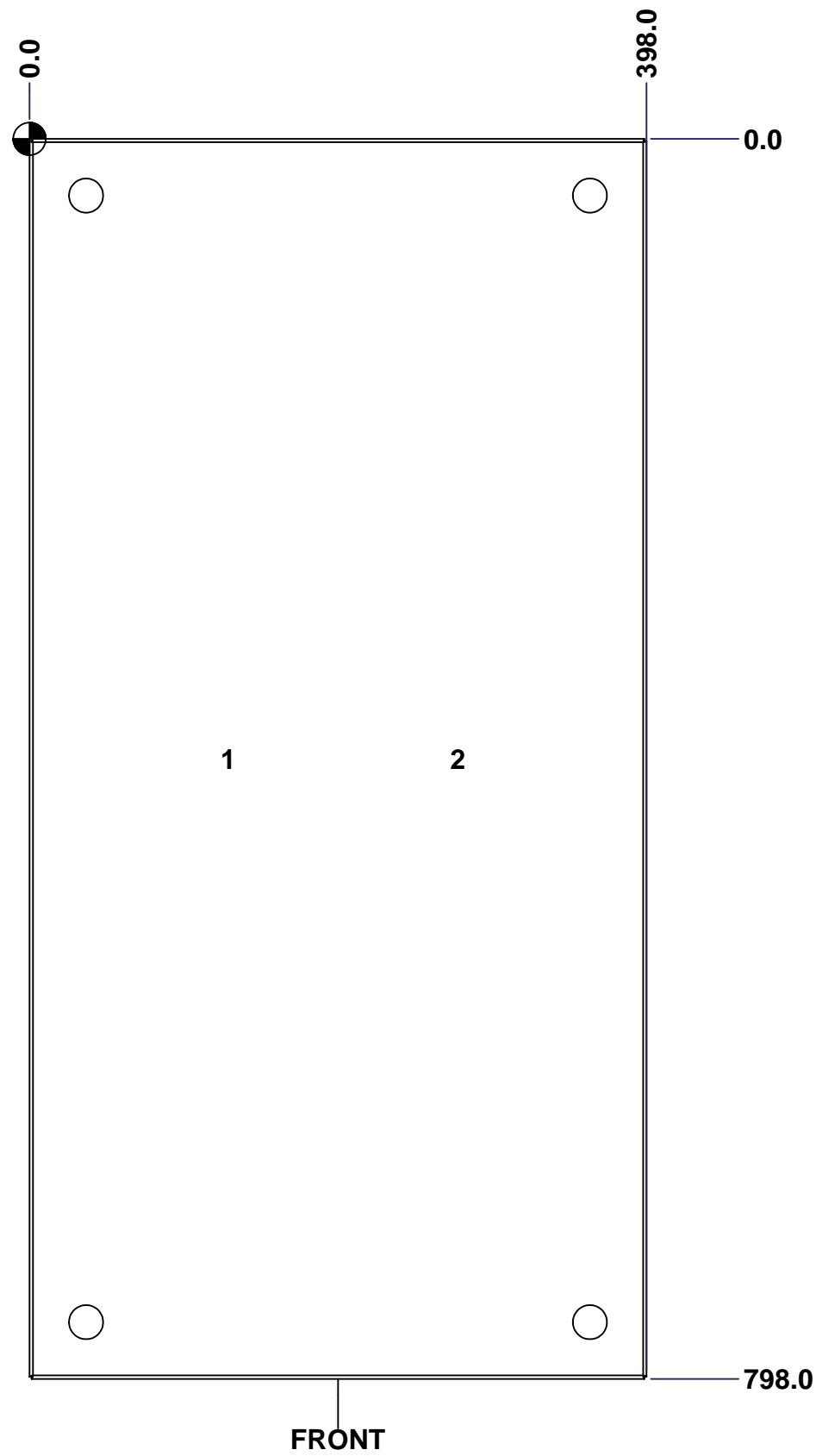

	Description		Status
	6500 MXT 400mm x 800mm Top		(NULL)
Part Number Numéro Pièce		Rev.	
6500MXK180408T		0	2 3

This drawing is confidential and must not be reproduced or used without the consent of EXM

Ce dessin est confidentiel et ne doit pas être reproduit ou utilisé sans le consentement de EXM

No.	Revisions	Date	By/Par

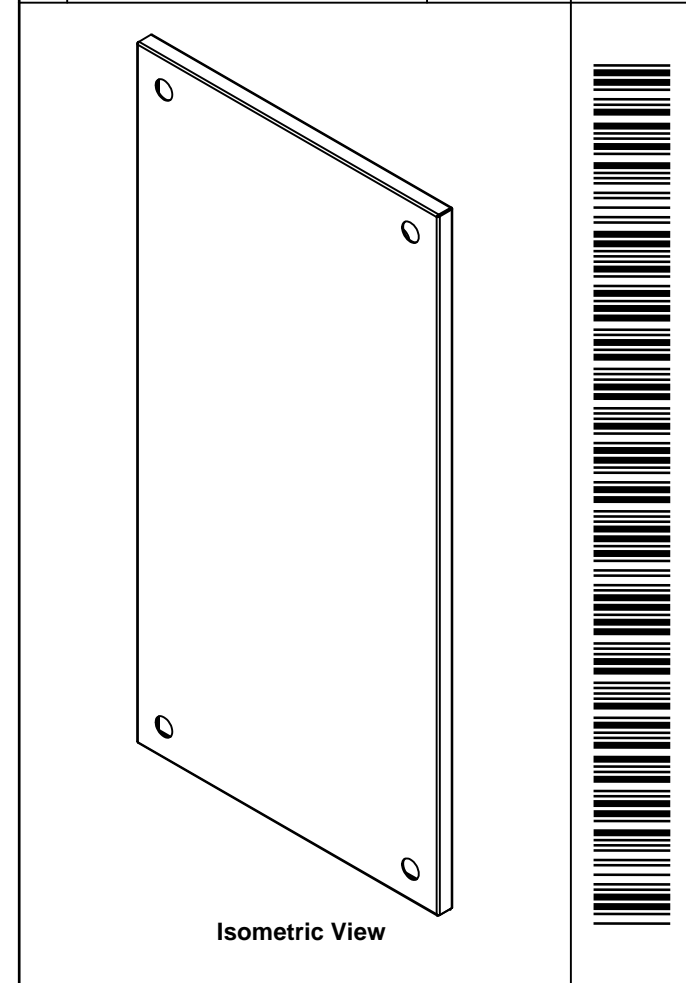

Tél: (450) 979-4373 Fax: (450) 979-4626 www.exmweb.com		Flatness Aplatissement	
		Max 3.0mm Projection	
Customer Client		Date	
Drawn By Dessiné Par		Date	
BoxCad: Annie		09/02/2015	
Material Matière			
16 Ga H.R.P. & O. (1.4mm)			
Color Couleur		Finish Fini	
Iron Grey RAL7011		Rough Textured	
Description			Detail Rev.
6500 MXT 400mm x 800mm Top			
Part Number Numéro Pièce		Rev.	3
6500MXK180408T		0	3

Qty	Part Number	Rev	Description
1	STK-P-03810R	0	Powder Paint (Iron Grey / Rough Textured)
2	STK-Q-16080	0.1.1	M6 x 16mm Ground Stud
1	6500MXK180408TG	0	6500 MXT 400mm x 800mm Top Gasket
1	6500MXK180408T-P	0	6500 MXT 400mm x 800mm Top Part
Parts List			

This drawing is confidential and must not be reproduced or used without the consent of EXM

Ce dessin est confidentiel et ne doit pas être reproduit ou utilisé sans le consentement de EXM

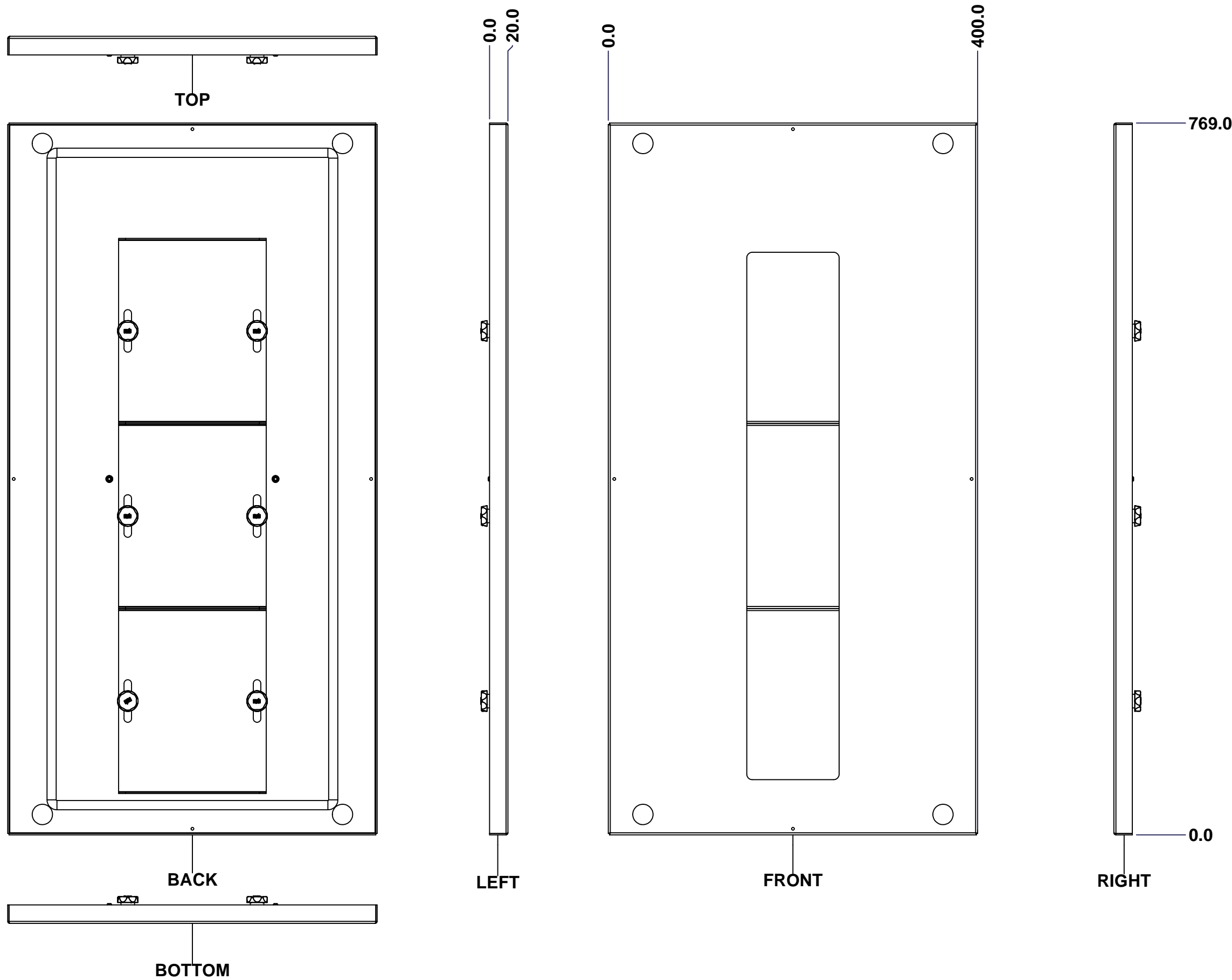

No.	Revisions	Date	By/Par

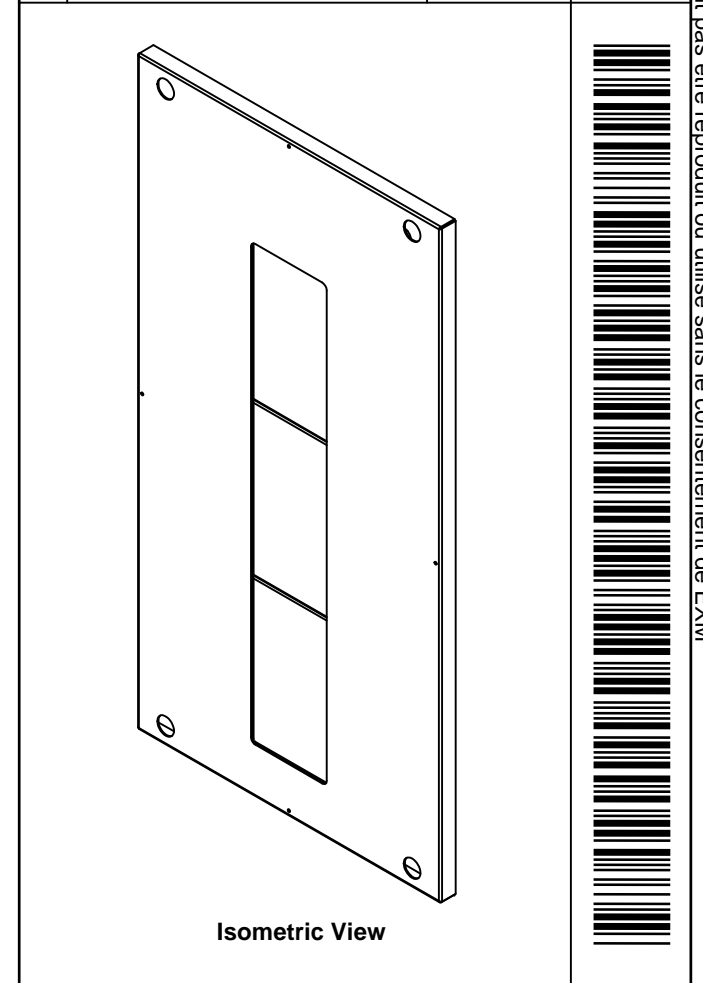

		Flatness Aplatissement Max 3.0mm Projection	
		Tél: (450) 979-4373 Fax: (450) 979-4626 www.exmweb.com	
Customer Client		Date	
Drawn By / Dessiné Par: BoxCad: Annie		Date: 09/02/2015	
Material / Matière: 16 Ga H.R.P. & O. (1.4mm)		Color / Couleur: Iron Grey RAL7011	
Description: 6500 MXB 400mm x 800mm Bottom		Finish / Fini: Rough Textured	
Part Number / Numéro Pièce: 6500MXK180408BT		Detail Rev.:	
SEE BILL OF MATERIAL ON LAST PAGE		Rev.:	1 / 3

This drawing is confidential and must not be reproduced or used without the consent of EXM

Ce dessin est confidentiel et ne doit pas être reproduit ou utilisé sans le consentement de EXM

STANDARD FEATURES ARE NOT LISTED IN THIS HOLE TABLE

HOLE TABLE - FRONT VIEW (CUSTOM FEATURE ONLY)

CUT-OUT	XDIM	YDIM	DESCRIPTION
1	110.0	384.5	GND STUD M6 x 16mm (Inside)
2	290.0	384.5	GND STUD M6 x 16mm (Inside)
3	130.0	544.5	GP STUD M6 x 10mm (Inside)
4	270.0	544.5	GP STUD M6 x 10mm (Inside)
5	130.0	344.5	GP STUD M6 x 10mm (Inside)
6	270.0	344.5	GP STUD M6 x 10mm (Inside)
7	130.0	144.5	GP STUD M6 x 10mm (Inside)
8	270.0	144.5	GP STUD M6 x 10mm (Inside)

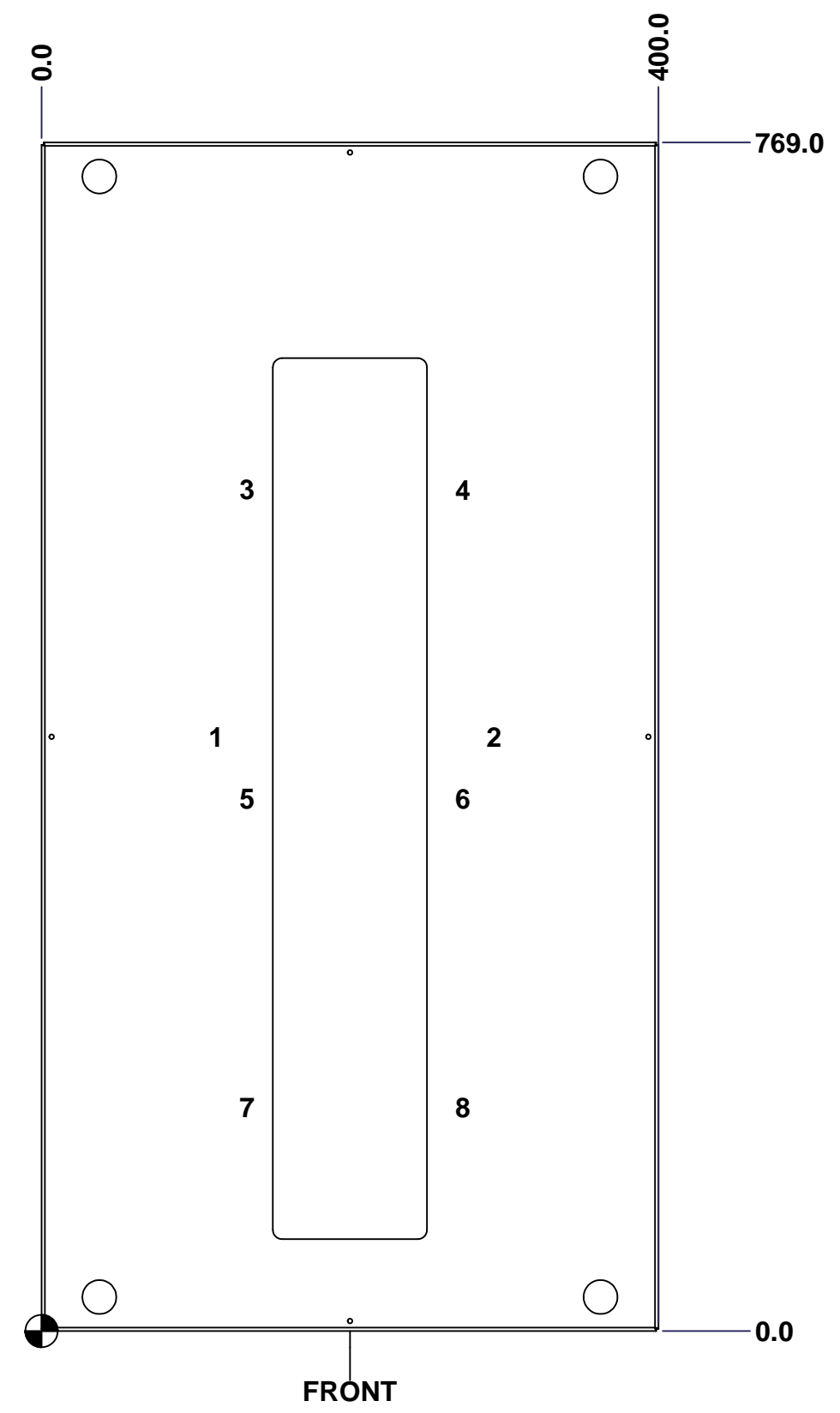

	Description	Status
	6500 MXB 400mm x 800mm Bottom	(NULL)
	Part Number Numéro Pièce	Rev.
	6500MXK180408BT	0
		2
		3

This drawing is confidential and must not be reproduced or used without the consent of EXM

Ce dessin est confidentiel et ne doit pas être reproduit ou utilisé sans le consentement de EXM

No.	Revisions	Date	By/Par

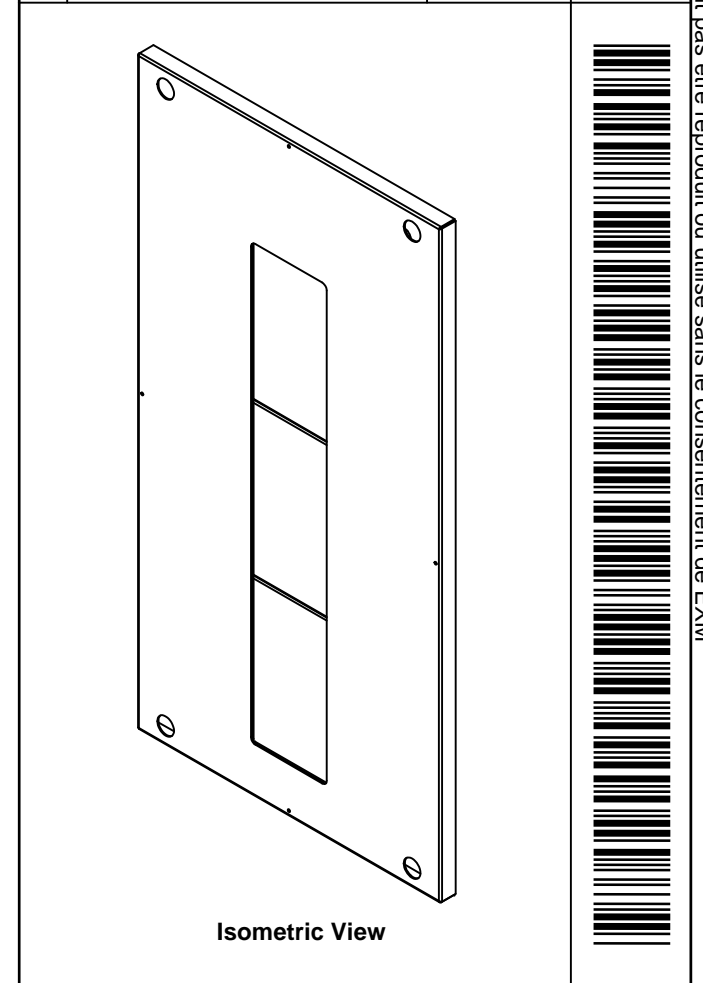

Tél: (450) 979-4373 Fax: (450) 979-4626 www.exmweb.com		Flatness Aplatissement	
		Max 3.0mm Projection	
Customer Client		Date	
Drawn By Dessiné Par		Date	
BoxCad: Annie		09/02/2015	
Material Matière		16 Ga H.R.P. & O. (1.4mm)	
Color Couleur		Iron Grey RAL7011	Finish Fini
			Rough Textured
Description			Detail Rev.
6500 MXB 400mm x 800mm Bottom			
Part Number Numéro Pièce		Rev.	3
6500MXK180408BT		0	3

Qty	Part Number	Rev	Description
1	STK-P-03810R	0	Powder Paint (Iron Grey / Rough Textured)
6	STK-Q-06001	0	Mtrx - Gland Plate M6 Plastic Thumb Nut
2	STK-Q-16055	1	M6 x 18mm Stud (No Paint Cap Required)
3	6500MXK180408GP200-P	0	6500 MXB 400mm Gland Plate Part (200mm)
6	STK-Q-16031	0	M6 x 10mm Stud (No Paint Cap Required)
1	6500MXK180408BTGPG	0	6500 MXB 400mm x 800mm Bottom Gland Plate Gasket
1	6500MXK180408BTG	0	6500 MXB 400mm x 800mm Bottom Gasket
1	6500MXK180408BT-P	0	6500 MXB 400mm x 800mm Bottom Part
Parts List			

This drawing is confidential and must not be reproduced or used without the consent of EXM

Ce dessin est confidentiel et ne doit pas être reproduit ou utilisé sans le consentement de EXM

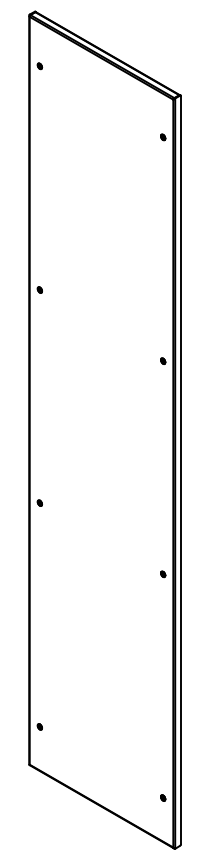
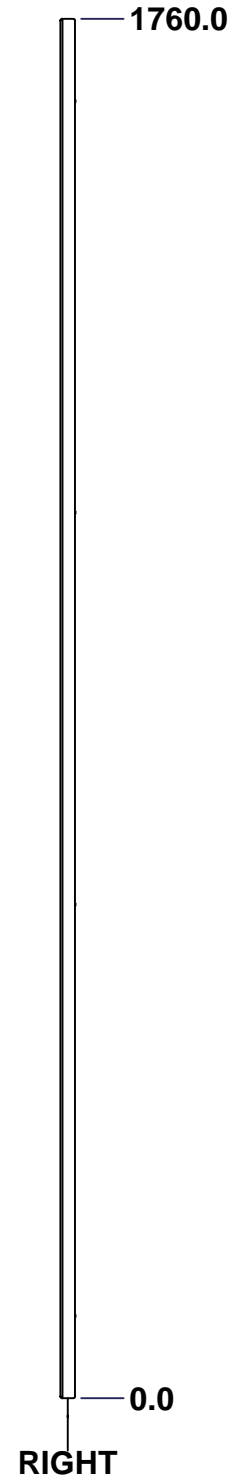
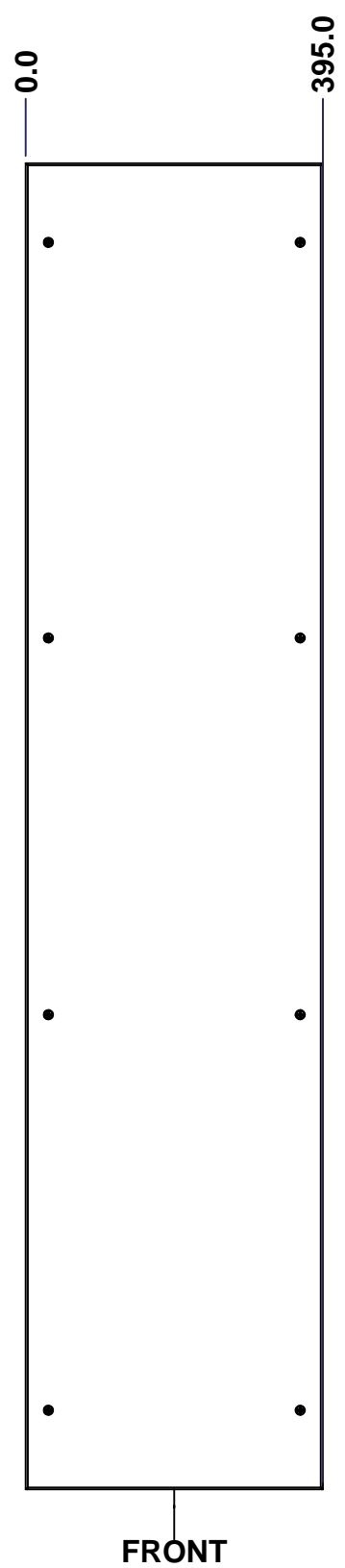
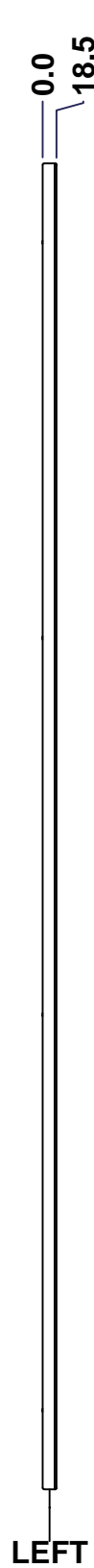
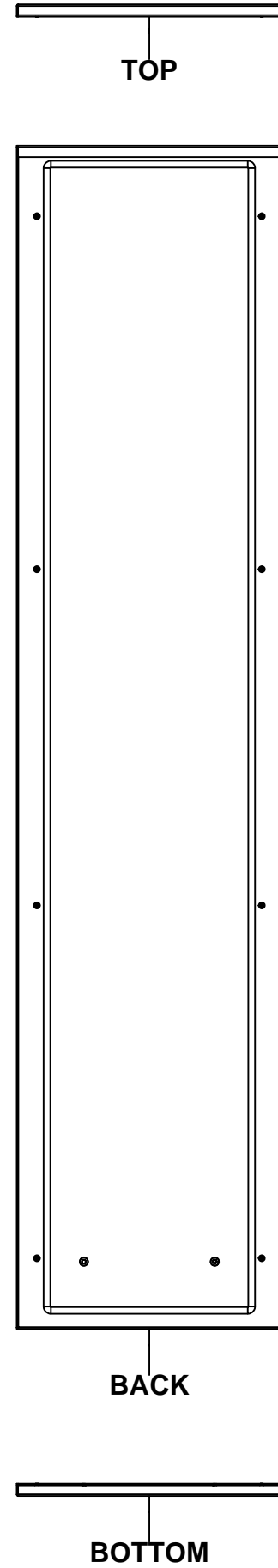

Isometric View

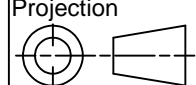

No.	Revisions	Date	By/Par

 Tél: (450) 979-4373 Fax: (450) 979-4626 www.exmweb.com		Flatness Aplatissement Max 3.0mm Projection 
Customer Client	Date	Date
Drawn By Dessiné Par	BoxCad: Annie	09/02/2015
Material Matière	14 Ga H.R.P. & O. (1.7mm)	
Color Couleur	Light Grey RAL7035	Finish Fini
Description		Detail Rev.
6500 MXR 1800mm x 400mm Back		
Part Number Numéro Pièce	Rev.	
6500MXK180408B	0	1 / 3

SEE BILL OF MATERIAL ON LAST PAGE

This drawing is confidential and must not be reproduced or used without the consent of EXM

Ce dessin est confidentiel et ne doit pas être reproduit ou utilisé sans le consentement de EXM

STANDARD FEATURES ARE NOT LISTED IN THIS HOLE TABLE			
HOLE TABLE - FRONT VIEW (CUSTOM FEATURE ONLY)			
CUT-OUT	XDIM	YDIM	DESCRIPTION
1	100.0	100.0	GND STUD M6 x 16mm (Inside)
2	295.0	100.0	GND STUD M6 x 16mm (Inside)

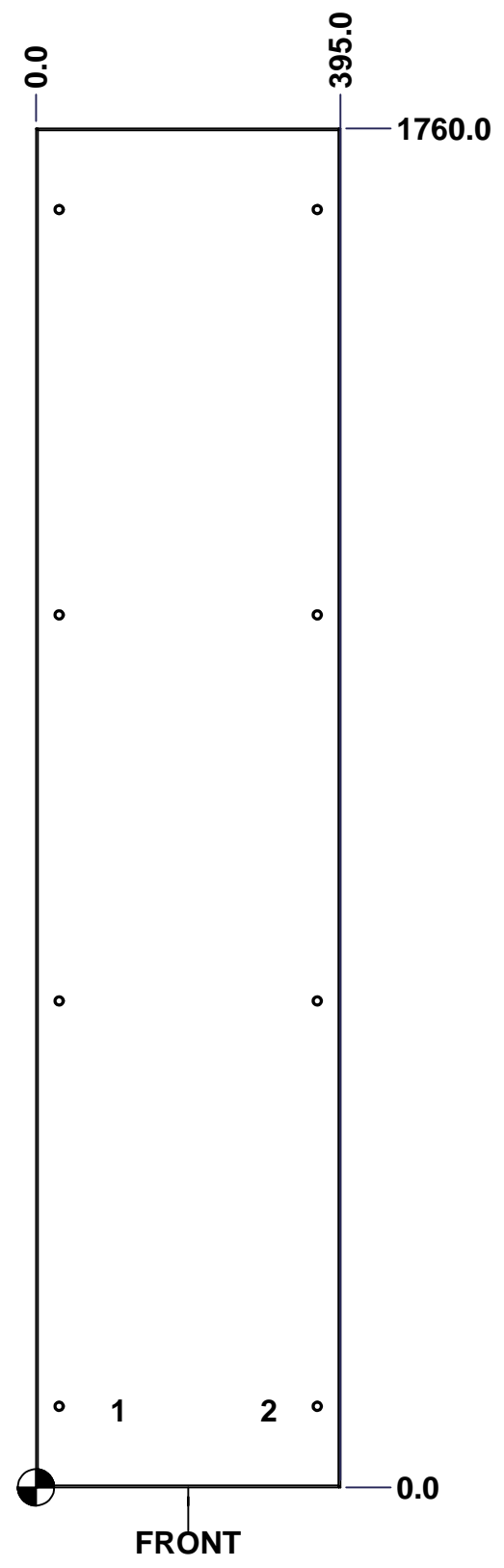

	Description	Status
	6500 MXR 1800mm x 400mm Back	(NULL)
	Part Number Numéro Pièce	Rev.
	6500MXK180408B	0
		2
		3

This drawing is confidential and must not be reproduced or used without the consent of EXM

Ce dessin est confidentiel et ne doit pas être reproduit ou utilisé sans le consentement de EXM

No.	Revisions	Date	By/Par

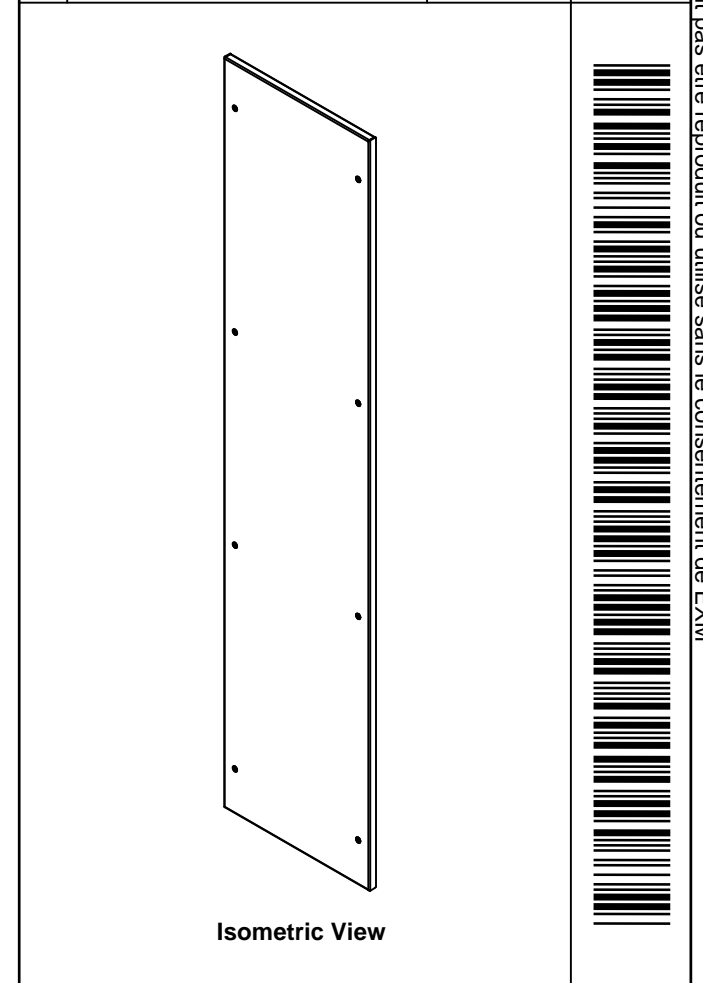

Tél: (450) 979-4373 Fax: (450) 979-4626 www.exmweb.com		Flatness Aplatissement	
		Max 3.0mm Projection	
Customer Client		Date	
Drawn By Dessiné Par BoxCad: Annie		Date 09/02/2015	
Material Matière 14 Ga H.R.P. & O. (1.7mm)			
Color Couleur Light Grey RAL7035		Finish Fini Rough Textured	
Description 6500 MXR 1800mm x 400mm Back			Detail Rev.
Part Number Numéro Pièce 6500MXK180408B			Rev. 3

Qty	Part Number	Rev	Description
1	STK-P-03820R	0	Powder Paint (Light Grey / Rough Textured)
8	STK-Q-03072	2	M6 x 17mm Phillips Flat Head Screw
2	STK-Q-16080	0.1.1	M6 x 16mm Ground Stud
1	6500MXK180408BG	0	6500 MXR 1800mm x 400mm Back Gasket
1	6500MXK180408B-P	0	6500 MXR 1800mm x 400mm Back Part
Parts List			

This drawing is confidential and must not be reproduced or used without the consent of EXM

Ce dessin est confidentiel et ne doit pas être reproduit ou utilisé sans le consentement de EXM

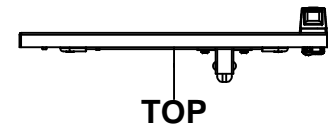

TOP

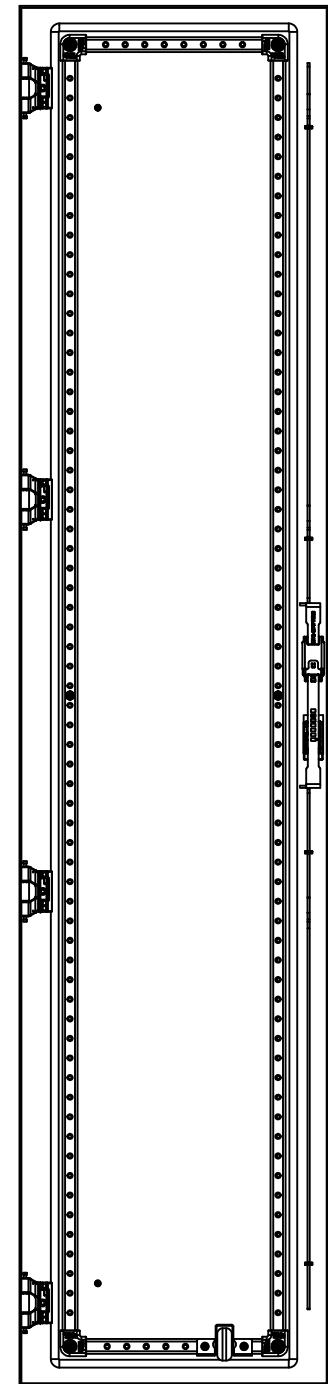

BACK

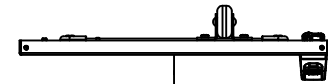

BOTTOM

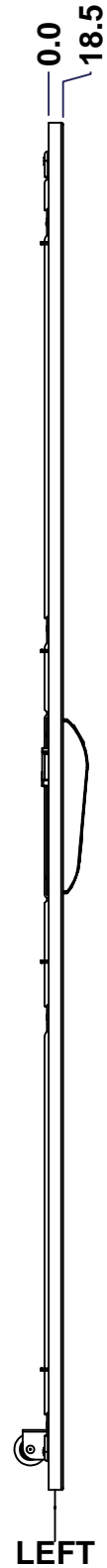

LEFT

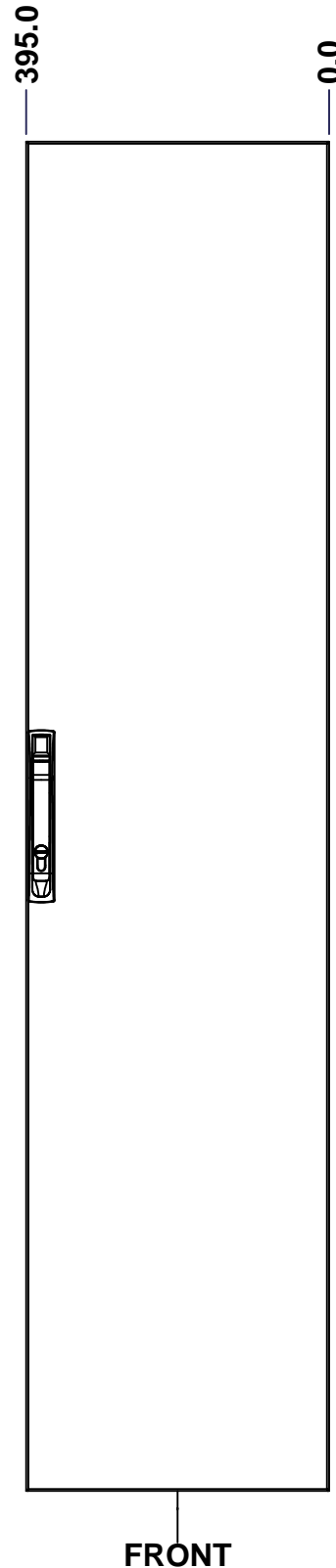

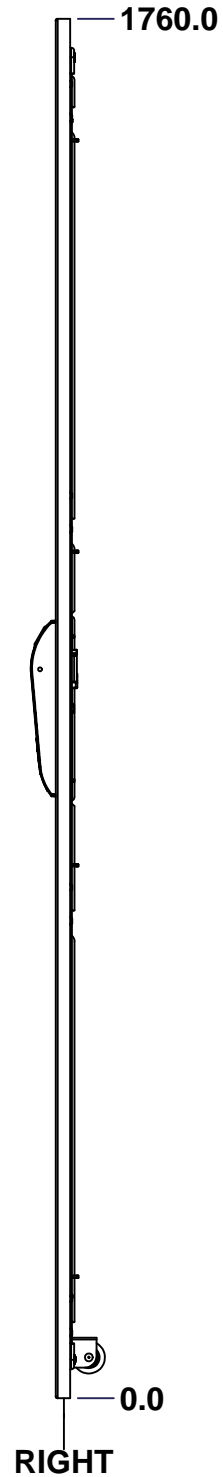

FRONT

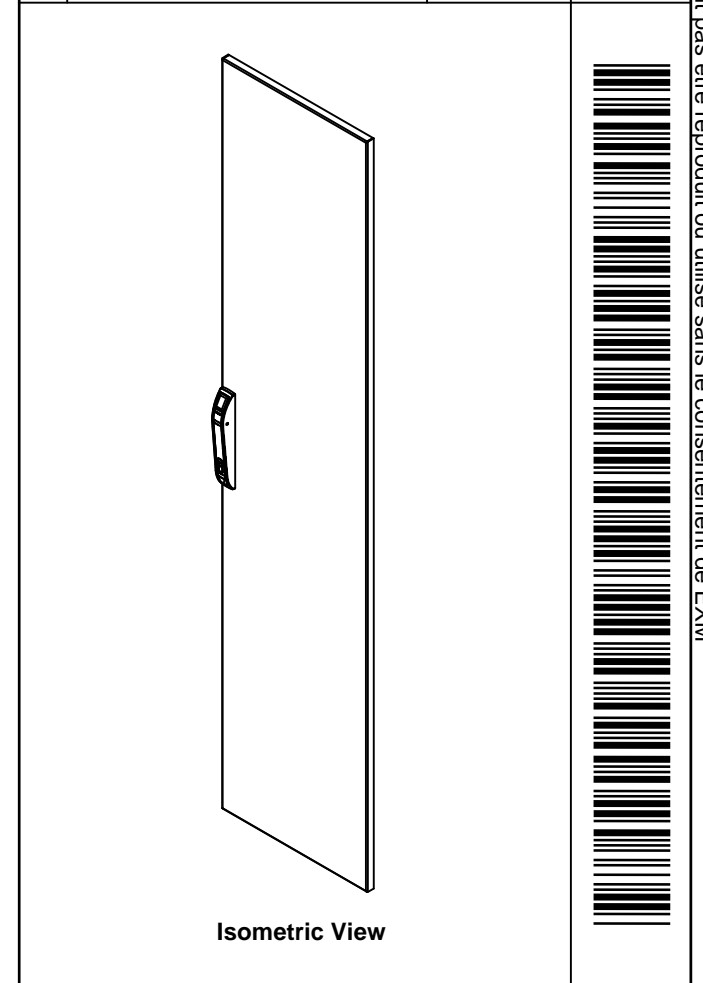

RIGHT

No.	Revisions	Date	By/Par

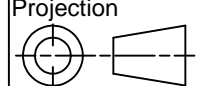

 Tél: (450) 979-4373 Fax: (450) 979-4626 www.exmweb.com		Flatness Aplatissement	
		Max 3.0mm	
Customer Client		Projection	
Date			
Drawn By Dessiné Par BoxCad: Annie		Date 09/02/2015	
Material Matière 14 Ga H.R.P. & O. (1.7mm)			
Color Couleur Light Grey RAL7035		Finish Fini Rough Textured	
Description 6500 MXD 1800mm x 400mm Front		Detail Rev.	
Part Number Numéro Pièce 6500MXK180408F		Rev. 0	1 3

SEE BILL OF MATERIAL ON LAST PAGE

This drawing is confidential and must not be reproduced or used without the consent of EXM

Ce dessin est confidentiel et ne doit pas être reproduit ou utilisé sans le consentement de EXM

STANDARD FEATURES ARE NOT LISTED IN THIS HOLE TABLE

HOLE TABLE - FRONT VIEW (CUSTOM FEATURE ONLY)

CUT-OUT	XDIM	YDIM	DESCRIPTION
1	100.0	130.0	GND STUD M6 x 16mm (Inside)
2	100.0	1630.0	GND STUD M6 x 16mm (Inside)
3	64.5	49.5	STIFF. STUD M6 x 18mm (Inside)
4	64.5	880.0	STIFF. STUD M6 x 18mm (Inside)
5	64.5	1710.5	STIFF. STUD M6 x 18mm (Inside)
6	330.5	49.5	STIFF. STUD M6 x 18mm (Inside)
7	330.5	880.0	STIFF. STUD M6 x 18mm (Inside)
8	330.5	1710.5	STIFF. STUD M6 x 18mm (Inside)
9	369.5	155.0	CLOSING BAR GUIDE (Inside)
10	369.5	1605.0	CLOSING BAR GUIDE (Inside)
11	369.5	680.0	CLOSING BAR GUIDE (Inside)
12	369.5	1080.0	CLOSING BAR GUIDE (Inside)

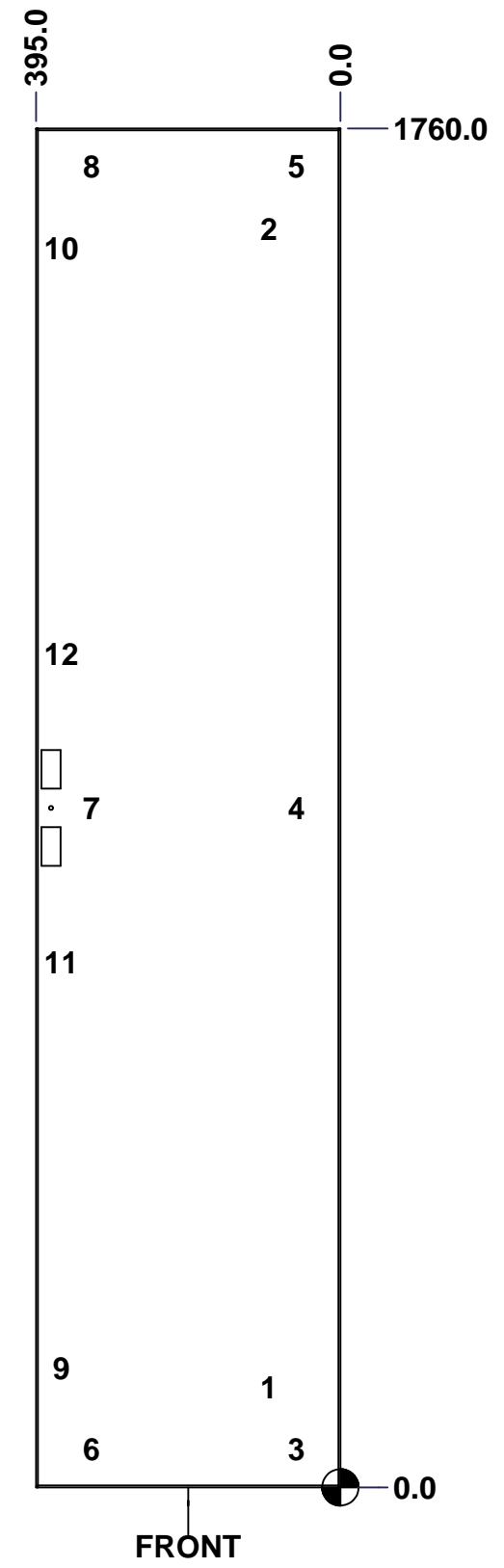

	Description	Status	
	6500 MXD 1800mm x 400mm Front	(NULL)	
	Part Number Numéro Pièce	Rev.	
	6500MXK180408F	0	2 3

This drawing is confidential and must not be reproduced or used without the consent of EXM

Ce dessin est confidentiel et ne doit pas être reproduit ou utilisé sans le consentement de EXM

No.	Revisions	Date	By/Par

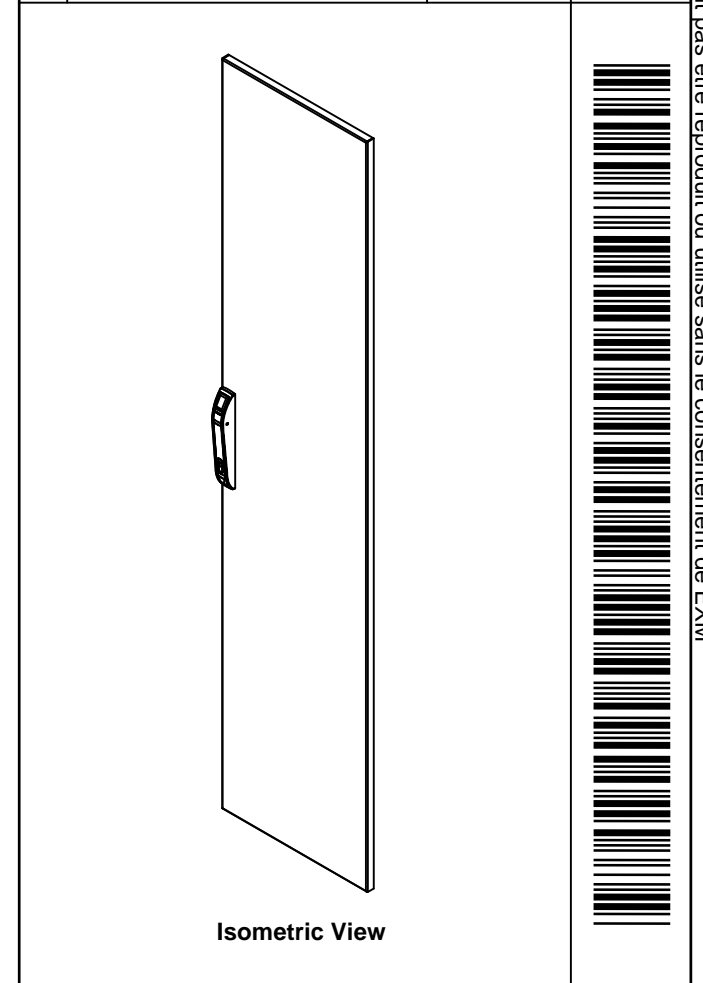

1	STK-P-03820R	0	Powder Paint (Light Grey / Rough Textured)
1	6500MXSRK	1	6500 MXRSK Door Support Roller
4	STK-Q-78022	0	Mtrx Closing Bar Slider
1	STK-Q-45746-18	1	6500 MXD - Lock Door Closing Bar
4	STK-Q-33105	4	5412 ESBU Buttable Hinge (Cover Part)
1	STK-Q-45729-18	2	6500 MXD - Lock Door Top Closing Bar
1	886PHD-S	4	Euroform Pull Handle Kit
8	STK-Q-16055	1	M6 x 18mm Stud (No Paint Cap Required)
1	6500MXK180408DS1	5	6500 MX 1800mm x 400mm Door Stiffener
1	6500MXK180408FG	0	6500 MXD 1800mm x 400mm Front Gasket
1	6500MXK180408F-P	0	6500 MXD 1800mm x 400mm Front Part
4	STK-K-06811	1	6500 MX - Hinge Assy
Qty	Part Number	Rev	Description
Parts List			



Tél: (450) 979-4373
Fax: (450) 979-4626
www.exmweb.com

Flatness
Aplatissement
Max 3.0mm

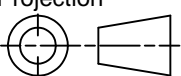
Projection

Customer Client		Date
Drawn By / Dessiné Par: BoxCad: Annie		Date: 09/02/2015
Material / Matière: 14 Ga H.R.P. & O. (1.7mm)		
Color / Couleur: Light Grey RAL7035	Finish / Fini: Rough Textured	
Description: 6500 MXD 1800mm x 400mm Front		Detail Rev.
Part Number / Numéro Pièce: 6500MXK180408F		Rev. 3
		0
		3

This drawing is confidential and must not be reproduced or used without the consent of EXM

Ce dessin est confidentiel et ne doit pas être reproduit ou utilisé sans le consentement de EXM

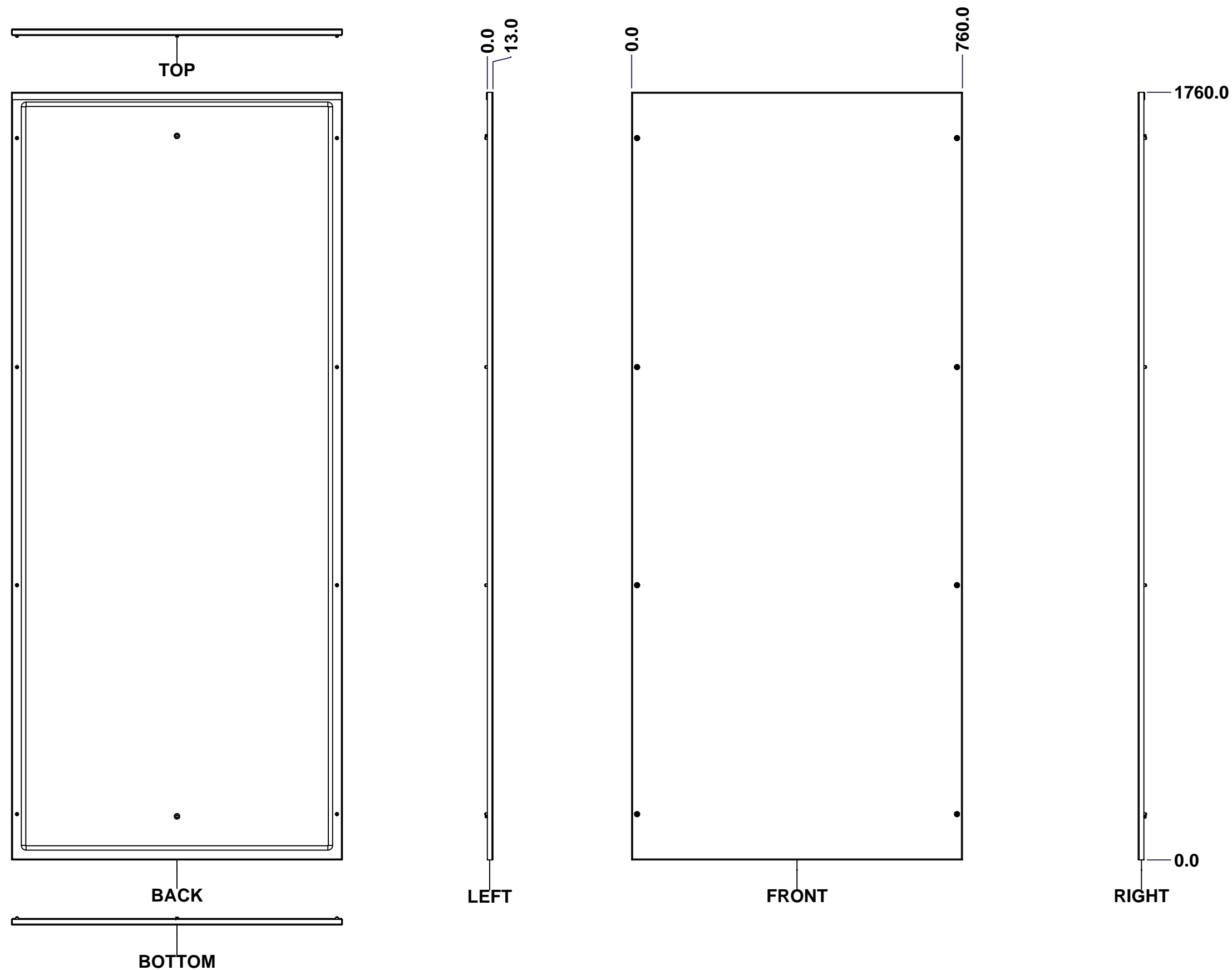

No.	Revisions	Date	By/Par

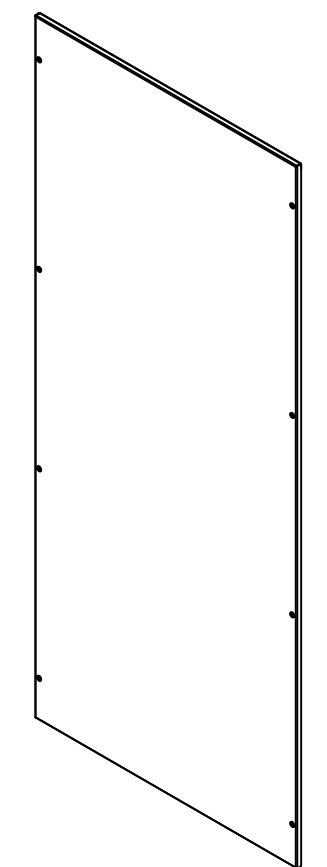

Isometric View

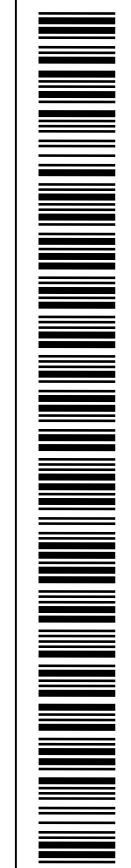

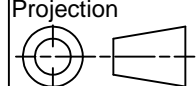
 Tél: (450) 979-4373 Fax: (450) 979-4626 www.exmweb.com		Flatness Aplatissement	
		Max 3.0mm	
Customer Client		Projection	
Date			
Drawn By Dessiné Par: BoxCad: Annie		Date: 09/02/2015	
Material Matière: 16 Ga H.R.P. & O. (1.4mm)		Color Couleur: Light Grey RAL7035	
Description 6500 MXC 1800mm x 800mm Left		Finish Fin: Rough Textured	
Part Number Numéro Pièce: 6500MXK180408L		Detail Rev.	
SEE BILL OF MATERIAL ON LAST PAGE		Rev. 0	1 / 3

This drawing is confidential and must not be reproduced or used without the consent of EXM

Ce dessin est confidentiel et ne doit pas être reproduit ou utilisé sans le consentement de EXM

STANDARD FEATURES ARE NOT LISTED IN THIS HOLE TABLE			
HOLE TABLE - FRONT VIEW (CUSTOM FEATURE ONLY)			
CUT-OUT	XDIM	YDIM	DESCRIPTION
1	380.0	100.0	GND STUD M6 x 16mm (Inside)
2	380.0	1660.0	GND STUD M6 x 16mm (Inside)

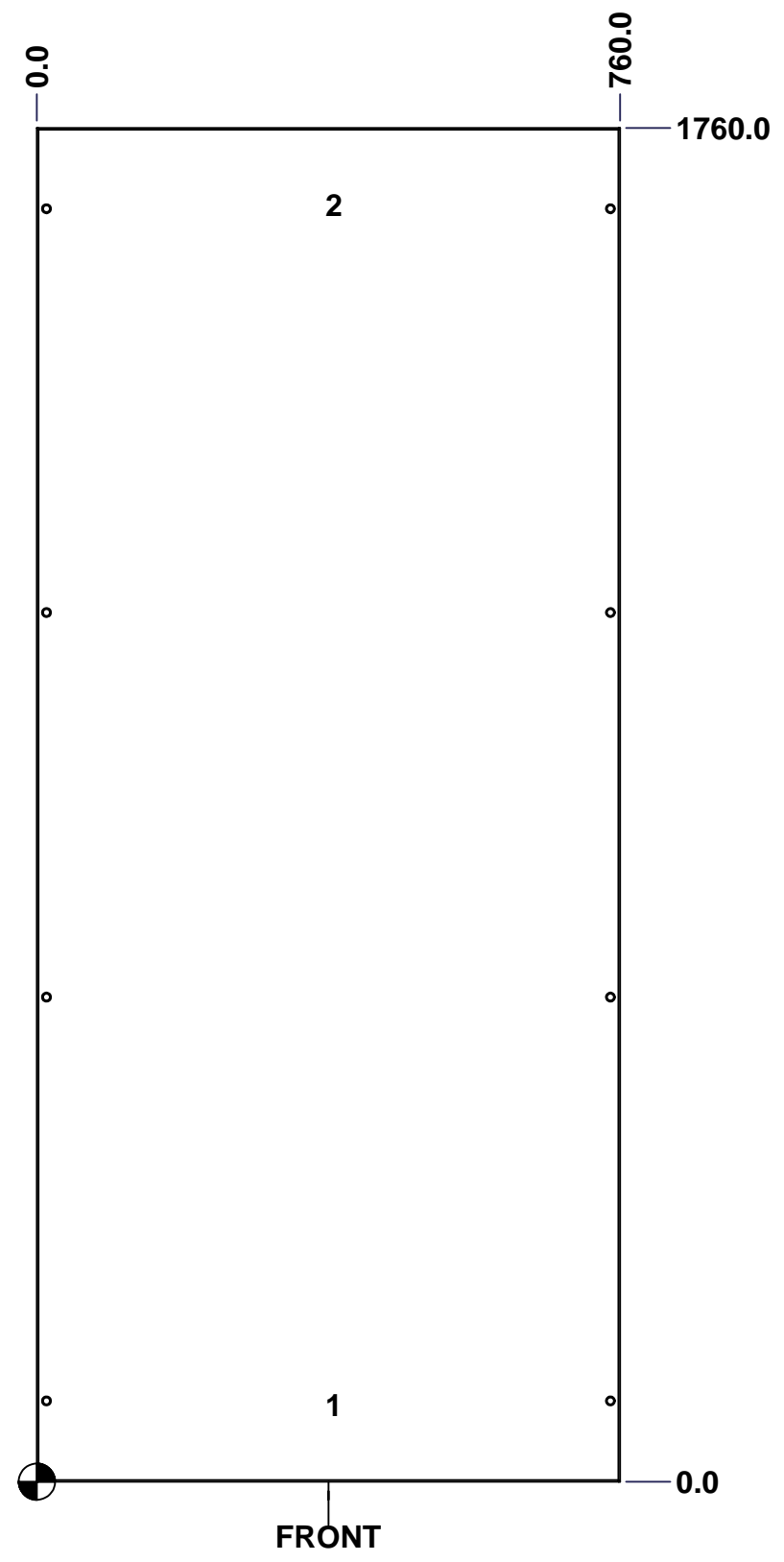

	Description	Status
	6500 MXC 1800mm x 800mm Left	(NULL)
	Part Number Numéro Pièce	Rev.
	6500MXK180408L	0
		2
		3

This drawing is confidential and must not be reproduced or used without the consent of EXM

Ce dessin est confidentiel et ne doit pas être reproduit ou utilisé sans le consentement de EXM

No.	Revisions	Date	By/Par

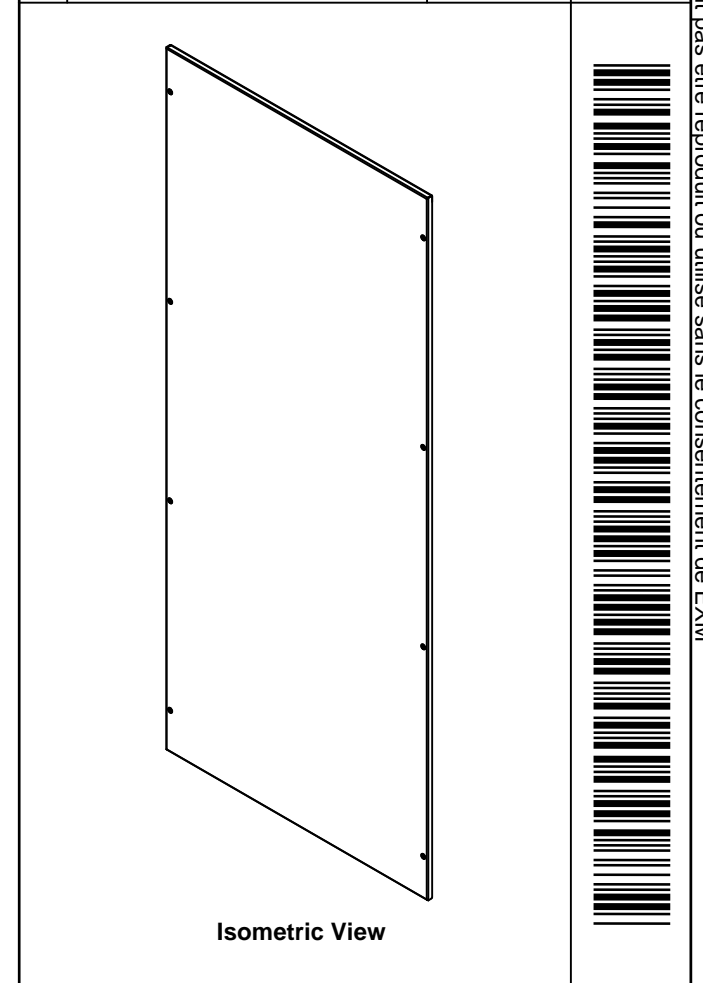

Tél: (450) 979-4373 Fax: (450) 979-4626 www.exmweb.com		Flatness Aplatissement	
		Max 3.0mm Projection	
Customer Client		Date	
Drawn By Dessiné Par BoxCad: Annie		Date 09/02/2015	
Material Matière 16 Ga H.R.P. & O. (1.4mm)			
Color Couleur Light Grey RAL7035		Finish Fini Rough Textured	
Description 6500 MXC 1800mm x 800mm Left			Detail Rev.
Part Number Numéro Pièce 6500MXK180408L		Rev. 0	3 3

Qty	Part Number	Rev	Description
1	STK-P-03820R	0	Powder Paint (Light Grey / Rough Textured)
8	STK-Q-03072	2	M6 x 17mm Phillips Flat Head Screw
2	STK-Q-16080	0.1.1	M6 x 16mm Ground Stud
1	6500MXK180408LG	0	6500 MXC 1800mm x 800mm Left Gasket
1	6500MXK180408L-P	0	6500 MXC 1800mm x 800mm Left Part
Parts List			

This drawing is confidential and must not be reproduced or used without the consent of EXM

Ce dessin est confidentiel et ne doit pas être reproduit ou utilisé sans le consentement de EXM

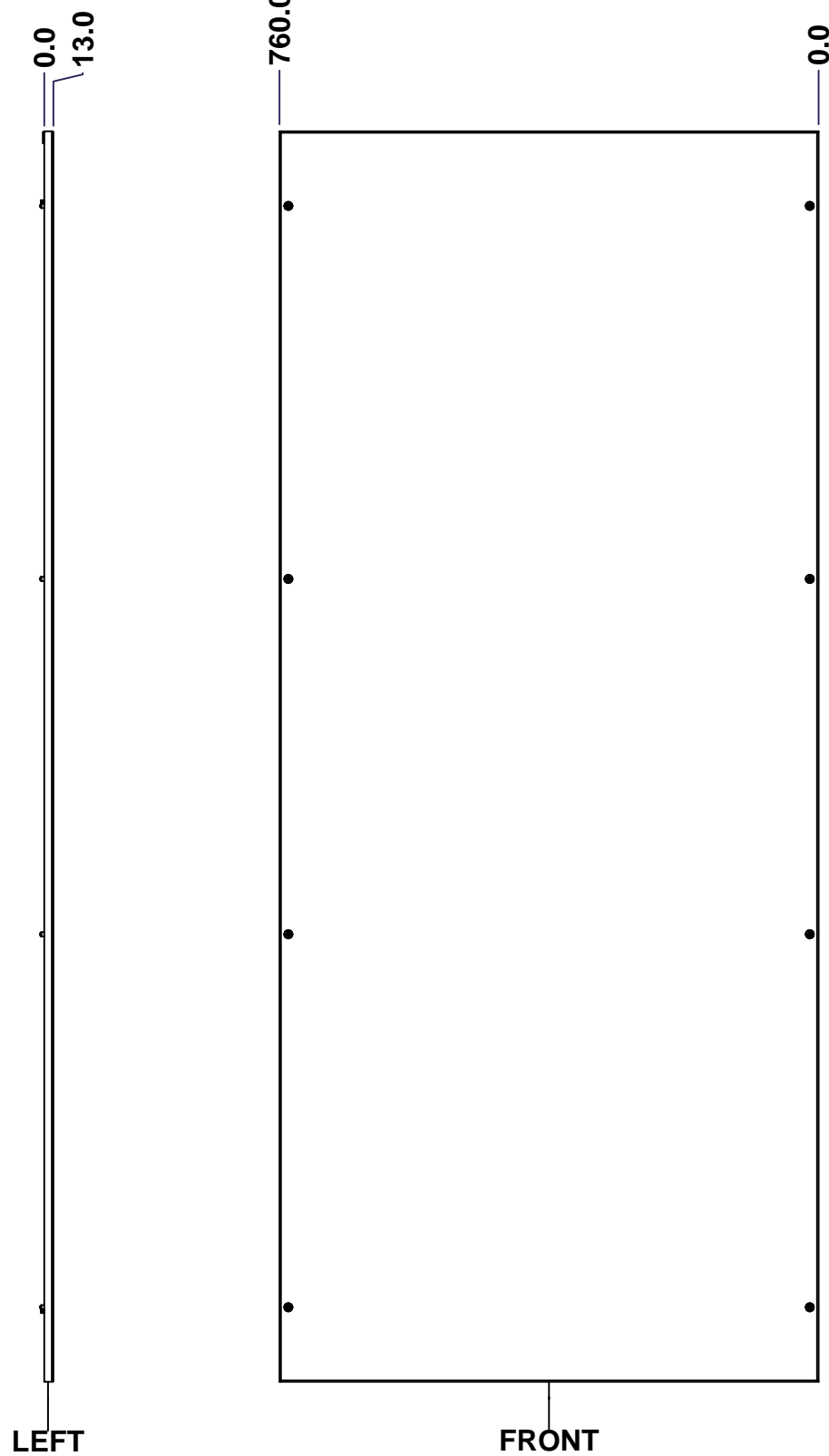
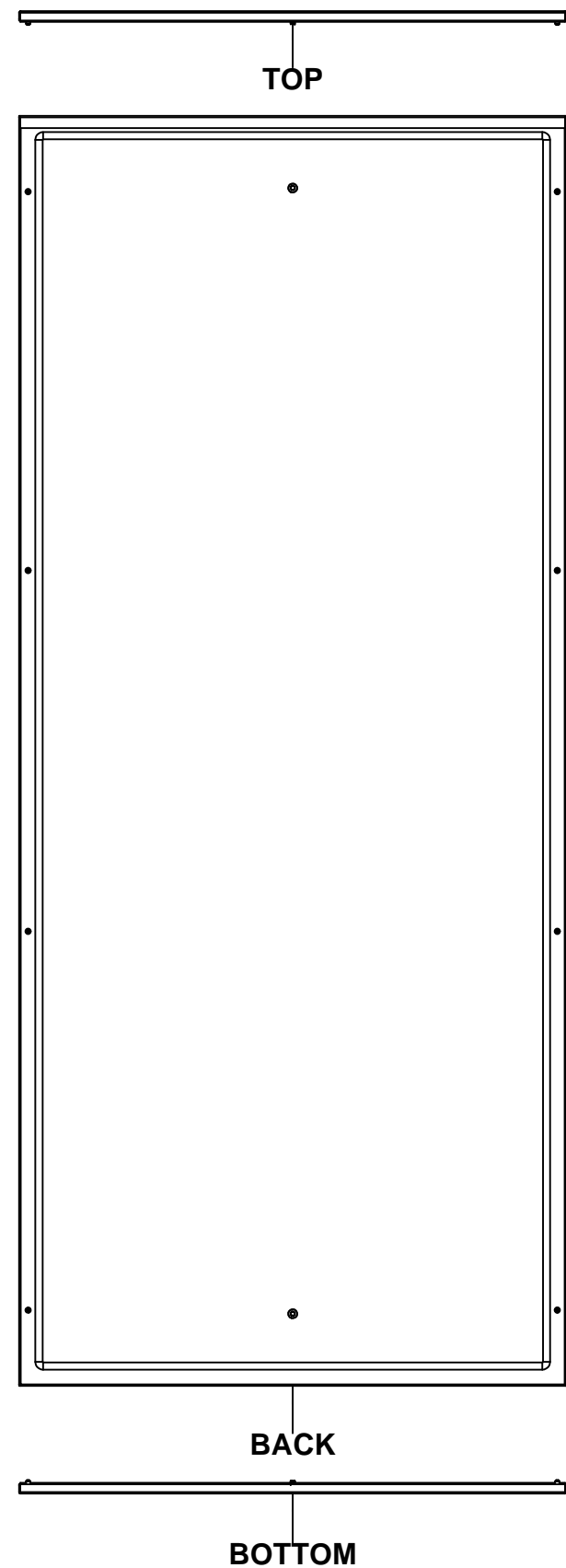

No.	Revisions	Date	By/Par

Isometric View

<p>Tél: (450) 979-4373 Fax: (450) 979-4626 www.exmweb.com</p>		Flatness Aplatissement Max 3.0mm	
		Projection 	
Customer Client		Date	
Drawn By / Dessiné Par: BoxCad: Annie		Date: 09/02/2015	
Material / Matière: 16 Ga H.R.P. & O. (1.4mm)		Color / Couleur: Light Grey RAL7035	
Description: 6500 MXC 1800mm x 800mm Right		Finish / Fini: Rough Textured	
Part Number / Numéro Pièce: 6500MXK180408R		Detail Rev.:	
SEE BILL OF MATERIAL ON LAST PAGE		Rev.:	1 3

This drawing is confidential and must not be reproduced or used without the consent of EXM

Ce dessin est confidentiel et ne doit pas être reproduit ou utilisé sans le consentement de EXM

STANDARD FEATURES ARE NOT LISTED IN THIS HOLE TABLE			
HOLE TABLE - FRONT VIEW (CUSTOM FEATURE ONLY)			
CUT-OUT	XDIM	YDIM	DESCRIPTION
1	380.0	100.0	GND STUD M6 x 16mm (Inside)
2	380.0	1660.0	GND STUD M6 x 16mm (Inside)

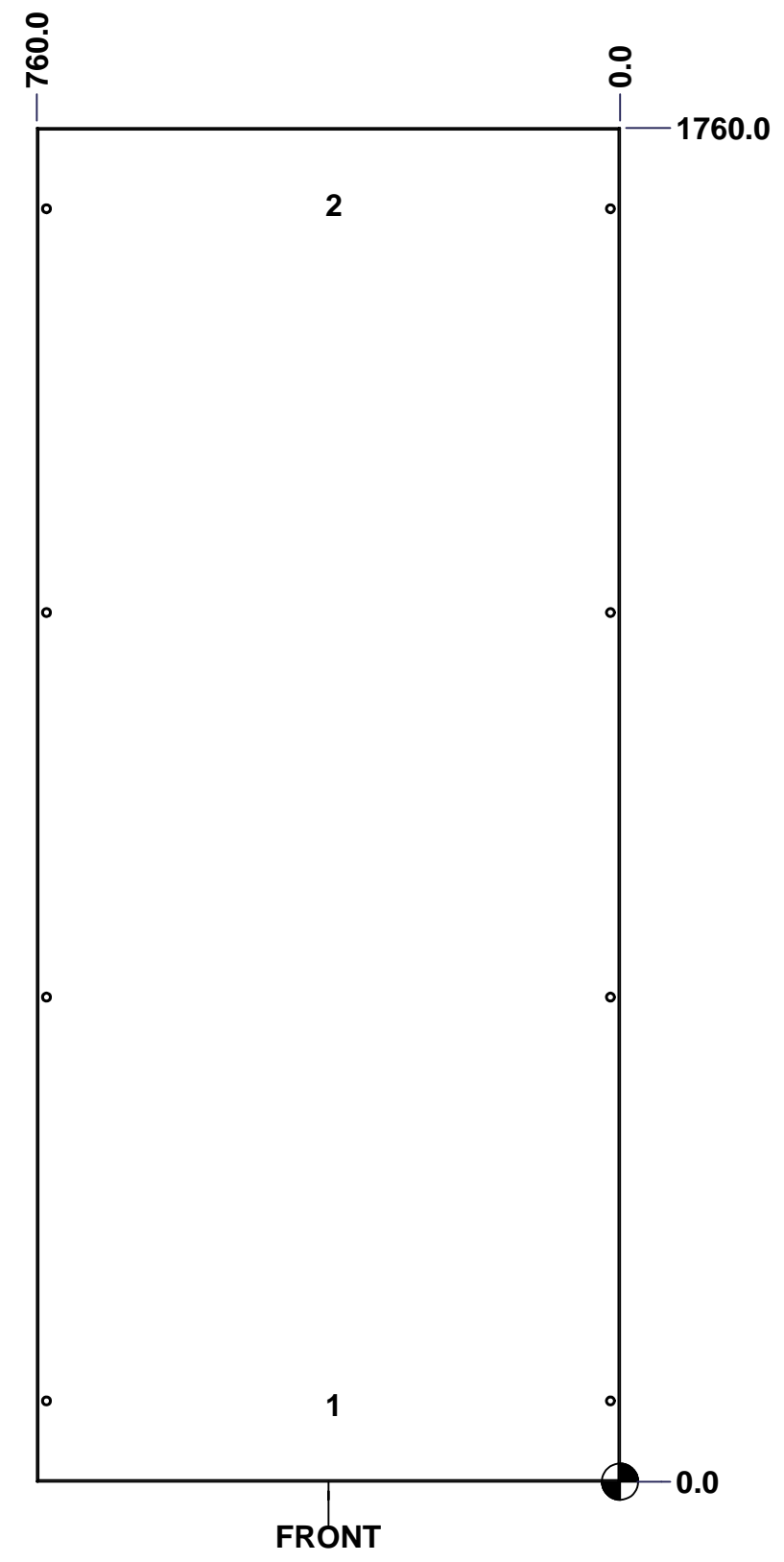

	Description	Status
	6500 MXC 1800mm x 800mm Right	(NULL)
	Part Number Numéro Pièce	Rev.
	6500MXK180408R	0
		2
		3

This drawing is confidential and must not be reproduced or used without the consent of EXM

Ce dessin est confidentiel et ne doit pas être reproduit ou utilisé sans le consentement de EXM

No.	Revisions	Date	By/Par

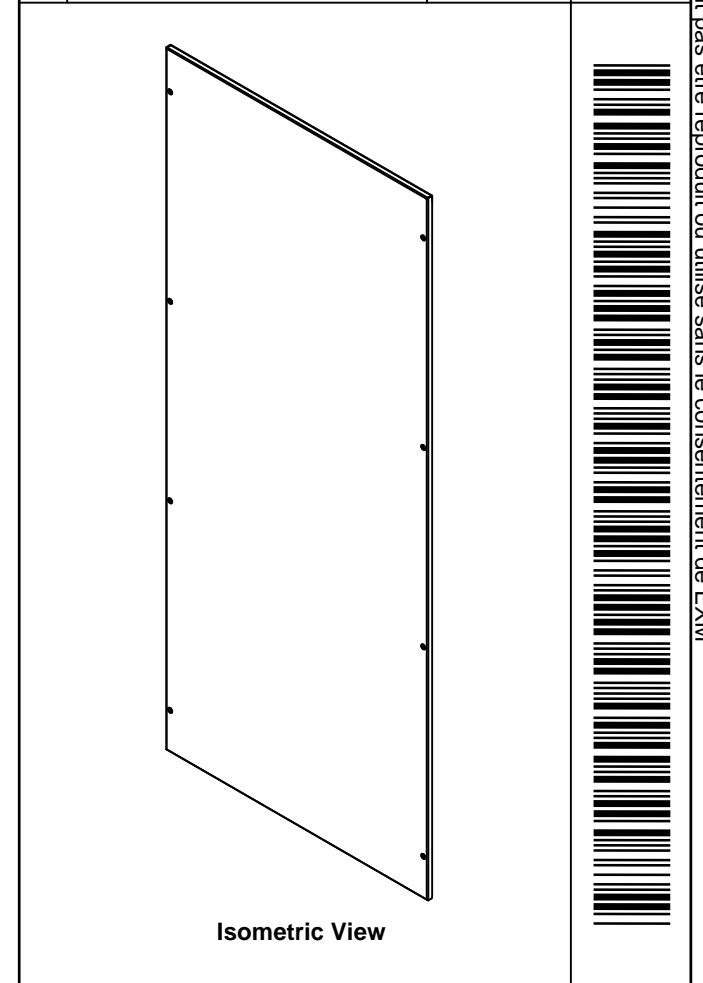

Tél: (450) 979-4373 Fax: (450) 979-4626 www.exmweb.com		Flatness Aplatissement	
		Max 3.0mm Projection	
Customer Client		Date	
Drawn By Dessiné Par BoxCad: Annie		Date 09/02/2015	
Material Matière 16 Ga H.R.P. & O. (1.4mm)			
Color Couleur Light Grey RAL7035		Finish Fini Rough Textured	
Description 6500 MXC 1800mm x 800mm Right			Detail Rev.
Part Number Numéro Pièce 6500MXK180408R		Rev. 0	3 3

Qty	Part Number	Rev	Description
1	STK-P-03820R	0	Powder Paint (Light Grey / Rough Textured)
8	STK-Q-03072	2	M6 x 17mm Phillips Flat Head Screw
2	STK-Q-16080	0.1.1	M6 x 16mm Ground Stud
1	6500MXK180408RG	0	6500 MXC 1800mm x 800mm Right Gasket
1	6500MXK180408R-P	0	6500 MXC 1800mm x 800mm Right Part
Parts List			

This drawing is confidential and must not be reproduced or used without the consent of EXM

Ce dessin est confidentiel et ne doit pas être reproduit ou utilisé sans le consentement de EXM

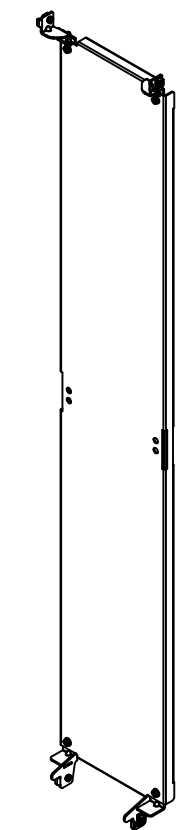
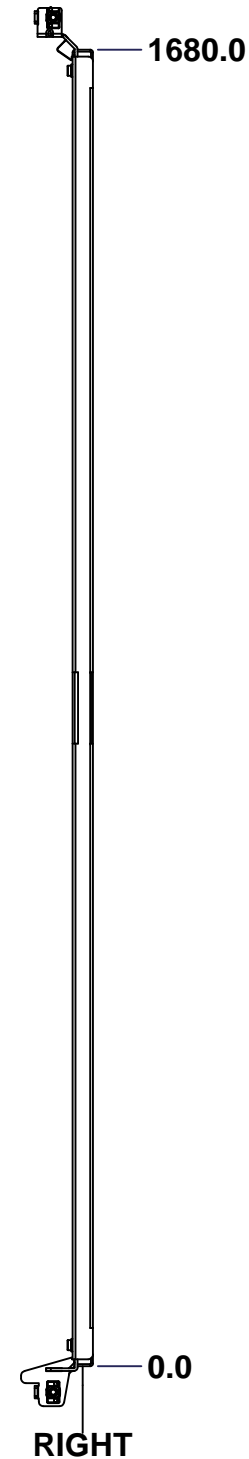
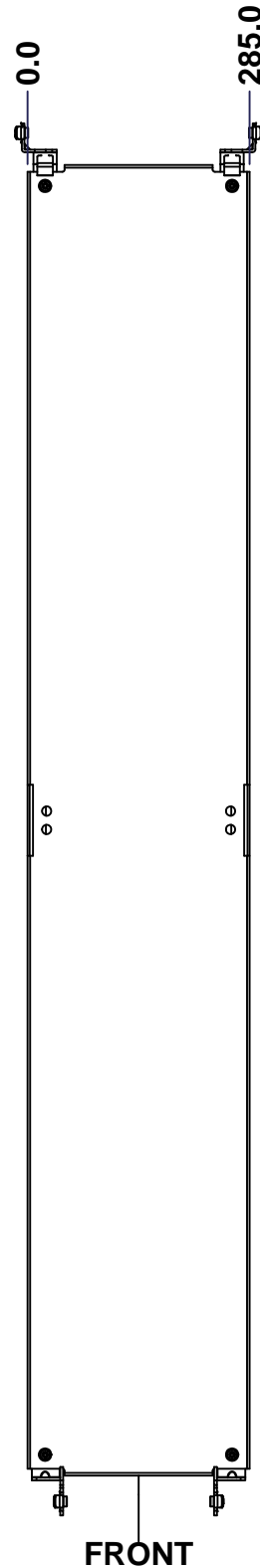
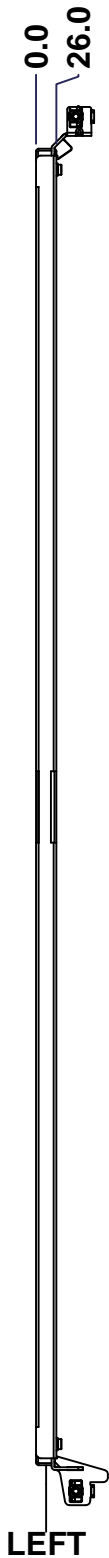
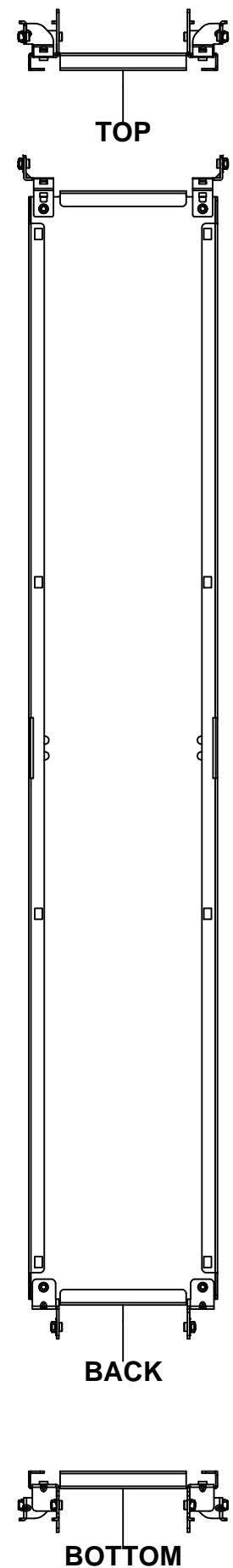

Isometric View

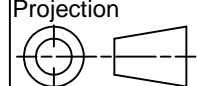

No.	Revisions	Date	By/Par

 Tél: (450) 979-4373 Fax: (450) 979-4626 www.exmweb.com		Flatness Aplatissement Max 3.0mm Projection 
Customer Client	Date	
Drawn By Dessiné Par	BoxCad: Annie	Date 09/02/2015
Material Matière	12 Ga Galvanized (2.5mm)	
Color Couleur	Unpainted	Finish Fini Unpainted
Description	Detail Rev.	
6500 MXM 1800mm x 400mm Back Inner Panel		
Part Number Numéro Pièce	Rev.	
6500MXK180408BIP	0	1 / 3

SEE BILL OF MATERIAL ON LAST PAGE

This drawing is confidential and must not be reproduced or used without the consent of EXM

Ce dessin est confidentiel et ne doit pas être reproduit ou utilisé sans le consentement de EXM

No.	Revisions	Date	By/Par

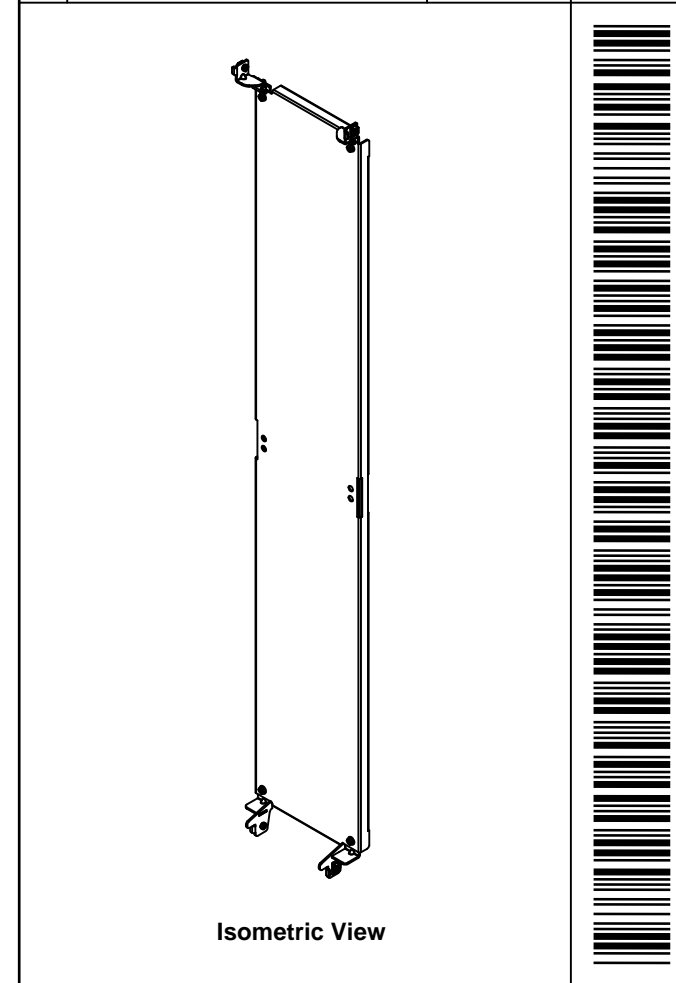

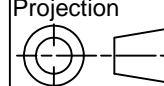
 Tél: (450) 979-4373 Fax: (450) 979-4626 www.exmweb.com		Flatness Aplatissement Max 3.0mm Projection 
Customer Client	Date	
Drawn By Dessiné Par	BoxCad: Annie	Date 09/02/2015
Material Matière	12 Ga Galvanized (2.5mm)	
Color Couleur	Unpainted	Finish Fini Unpainted
Description 6500 MXM 1800mm x 400mm Back Inner Panel		Detail Rev.
Part Number Numéro Pièce	6500MXK180408BIP	Rev. 3
		0

Qty	Part Number	Rev	Description
1	STK-A-49005	0	6500MXM - Bottom Inner Panel Support Kit (Right)
1	STK-A-49000	0	6500MXM - Bottom Inner Panel Support Kit (Left)
1	STK-A-49015	0	6500MXM - Top Inner Panel Support Kit (Right)
1	STK-A-49010	0	6500MXM - Top Inner Panel Support Kit (Left)
1	6500MXK180408BIP-P	0	6500 MXM 1800mm x 400mm Back Inner Panel Part
Parts List			