

This drawing is confidential and must not be reproduced or used without the consent of EXM

Ce dessin est confidentiel et ne doit pas être reproduit ou utilisé sans le consentement de EXM

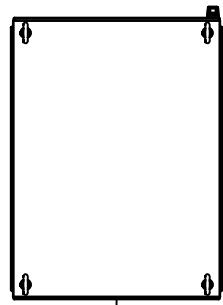

TOP

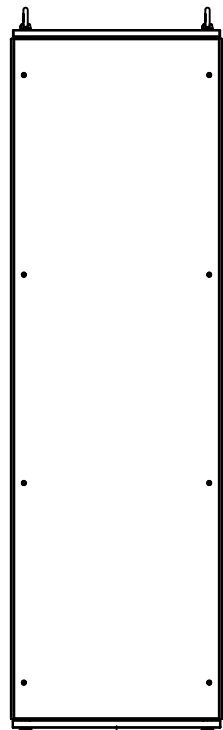

BACK

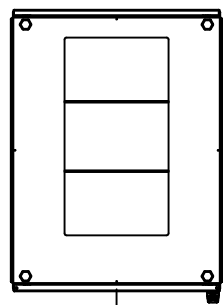

BOTTOM

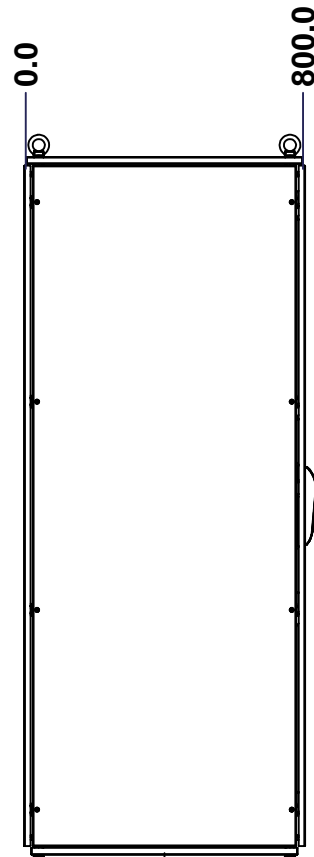

LEFT

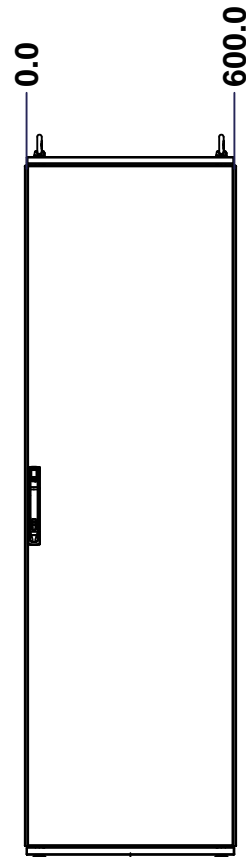

FRONT

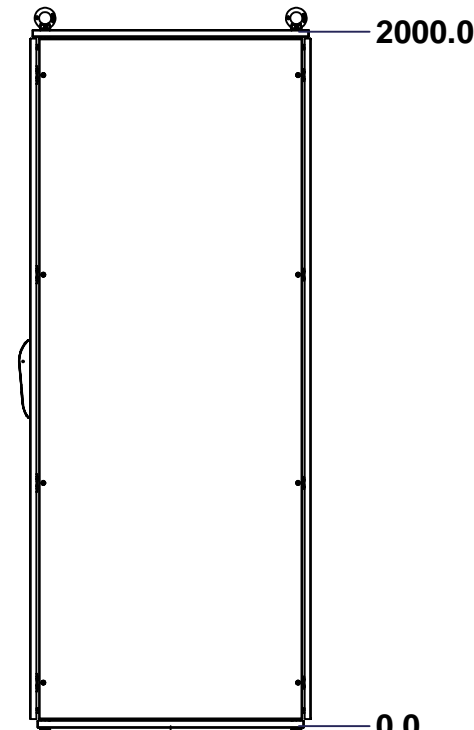

RIGHT

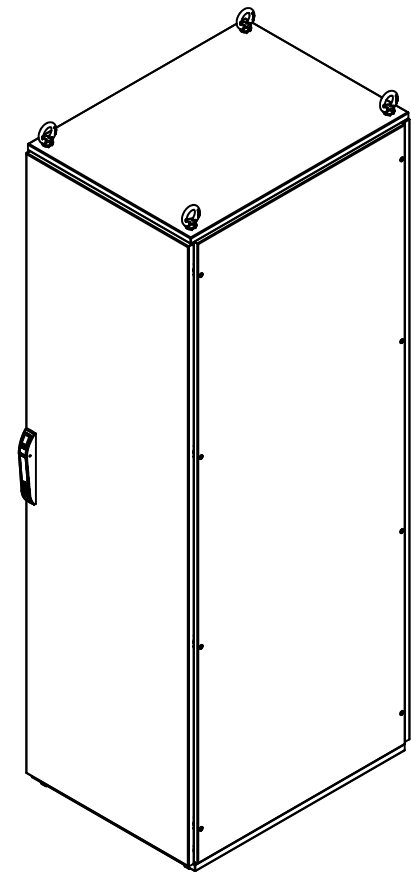

Isometric View

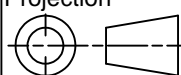

| No. | Revisions | Date       | By/Par |
|-----|-----------|------------|--------|
| 1   |           | 07/08/2014 |        |
|     |           |            |        |
|     |           |            |        |
|     |           |            |        |

|  |               |   |
|--|---------------|---|
|  Tél: (450) 979-4373<br>Fax: (450) 979-4626<br><a href="http://www.exmweb.com">www.exmweb.com</a> |               | Flatness<br>Aplatissement<br>Max 3.0mm<br>Projection<br> |
| Customer<br>Client   | Date          |   |
| Drawn By<br>Dessiné Par  | BoxCad: Annie | Date 08/04/2013   |
| Material<br>Matière  | See Part List |   |
| Color<br>Couleur   | See Part List | Finish<br>Fini See Part List  |
| Description<br>6500MX 2000mm x 600mm x 800mm<br>Assembly   |               | Detail Rev.   |
| Part Number<br>Numéro Pièce<br><b>6500MXK200608</b>  |               | Rev. 1/2  |

SEE BILL OF MATERIAL ON LAST PAGE

This drawing is confidential and must not be reproduced or used without the consent of EXM

Ce dessin est confidentiel et ne doit pas être reproduit ou utilisé sans le consentement de EXM

| No. | Revisions | Date       | By/Par |
|-----|-----------|------------|--------|
| 1   |           | 07/08/2014 |        |
|     |           |            |        |
|     |           |            |        |
|     |           |            |        |
|     |           |            |        |

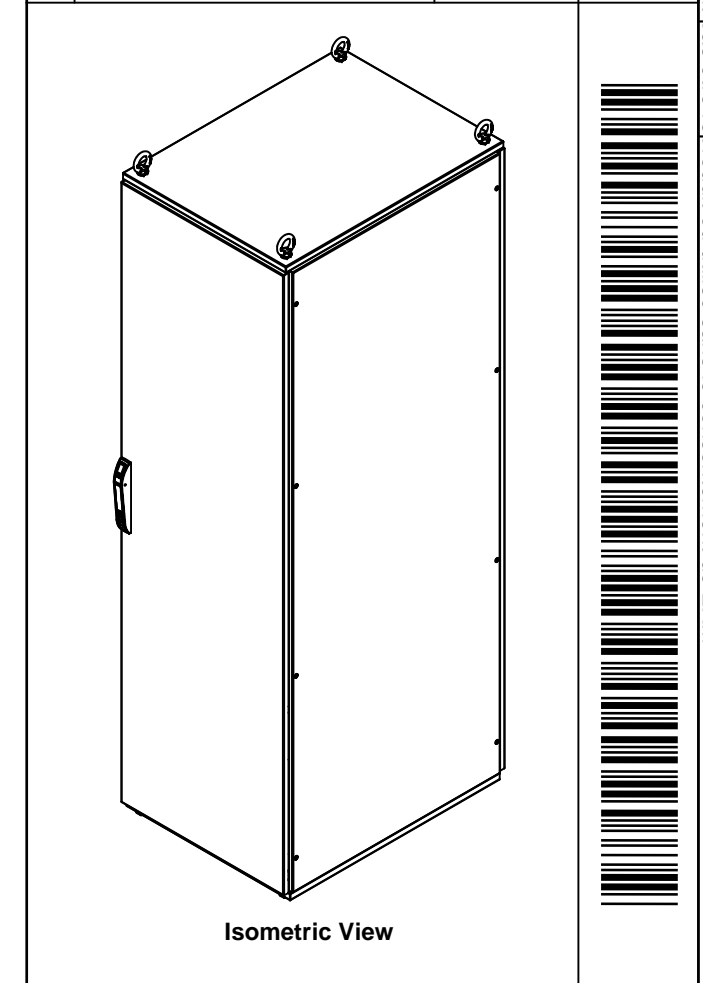

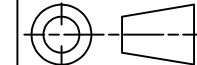
|  |                      |   |
|--|----------------------|---|
|  Tél: (450) 979-4373<br>Fax: (450) 979-4626<br><a href="http://www.exmweb.com">www.exmweb.com</a> |                      | Flatness<br>Aplatissement<br>Max 3.0mm<br>Projection<br> |
| Customer<br>Client   | Date                 |   |
| Drawn By<br>Dessiné Par  | BoxCad: Annie        | Date 08/04/2013   |
| Material<br>Matière  | See Part List        |   |
| Color<br>Couleur   | See Part List        | Finish<br>Fini See Part List  |
| Description<br>6500MX 2000mm x 600mm x 800mm<br>Assembly   |                      | Detail Rev.   |
| Part Number<br>Numéro Pièce  | <b>6500MXK200608</b> | Rev. 2<br><b>1</b> 2  |

| Qty        | Part Number      | Rev | Description                              |
|------------|------------------|-----|--|
| 1          | 6500MXK200608BIP | 1   | 6500 MXM 2000mm x 600mm Back Inner Panel |
| 1          | 6500MXK200608R   | 1   | 6500 MXC 2000mm x 800mm Right            |
| 1          | 6500MXK200608L   | 1   | 6500 MXC 2000mm x 800mm Left             |
| 1          | 6500MXK200608F   | 1   | 6500 MXD 2000mm x 600mm Front            |
| 1          | 6500MXK200608B   | 1   | 6500 MXR 2000mm x 600mm Back             |
| 1          | 6500MXK200608BT  | 1   | 6500 MXB 600mm x 800mm Bottom            |
| 1          | 6500MXK200608T   | 1   | 6500 MXT 600mm x 800mm Top               |
| 1          | 6500MXK200608FR  | 1   | 6500 MX 2000mm x 600mm x 800mm Frame     |
| Parts List |                  |     |  |

This drawing is confidential and must not be reproduced or used without the consent of EXM

Ce dessin est confidentiel et ne doit pas être reproduit ou utilisé sans le consentement de EXM

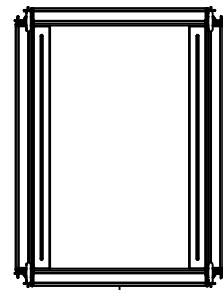

TOP

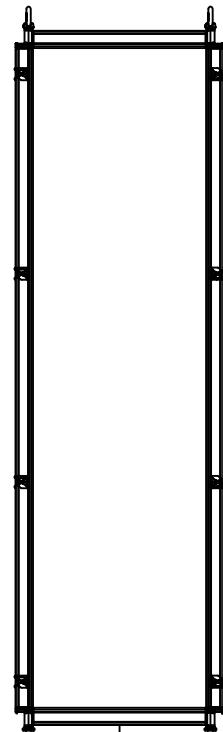

BACK

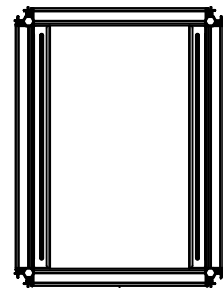

BOTTOM

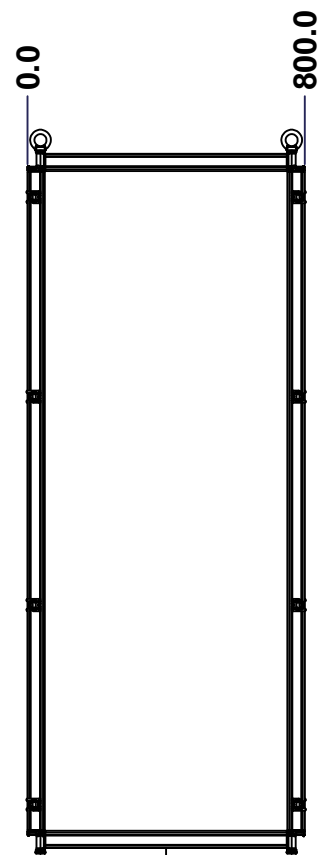

LEFT

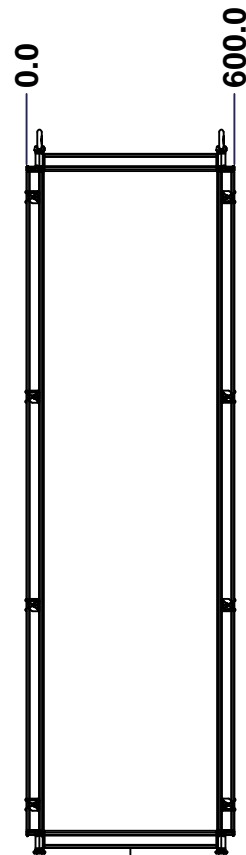

FRONT

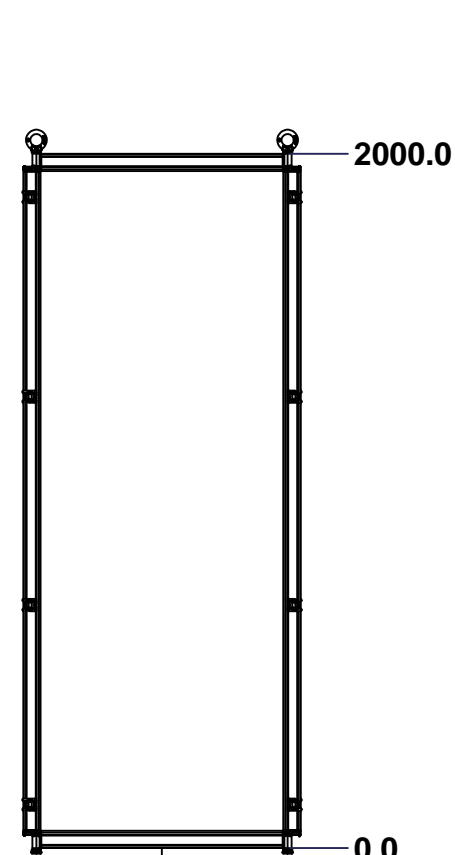

RIGHT

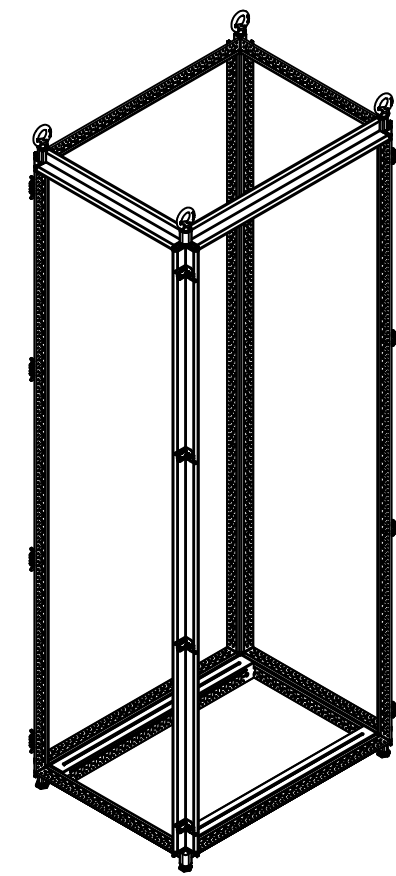

Isometric View

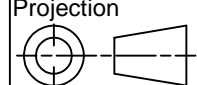

| No. | Revisions | Date       | By/Par |
|-----|-----------|------------|--------|
| 1   |           | 07/08/2014 |        |
|     |           |            |        |
|     |           |            |        |
|     |           |            |        |

|  |                                  |   |
|--|----------------------------------|---|
|  Tél: (450) 979-4373<br>Fax: (450) 979-4626<br><a href="http://www.exmweb.com">www.exmweb.com</a> |                                  | Flatness<br>Aplatissement<br>Max 3.0mm<br>Projection<br> |
| Customer<br>Client   | Date                             |   |
| Drawn By<br>Dessiné Par  | BoxCad: Annie                    | Date 08/04/2013   |
| Material<br>Matière  | 16 Ga Electro-Galvanized (1.4mm) |   |
| Color<br>Couleur   | Iron Grey RAL7011                | Finish<br>Fin<br>Rough<br>Textured  |
| Description  | Detail Rev.                      |   |
| 6500 MX 2000mm x 600mm x 800mm<br>Frame  |                                  |   |
| Part Number<br>Numéro Pièce  | Rev.                             |   |
| <b>6500MXK200608FR</b>   | <b>1</b>                         | 1<br>2  |

SEE BILL OF MATERIAL ON LAST PAGE

This drawing is confidential and must not be reproduced or used without the consent of EXM

Ce dessin est confidentiel et ne doit pas être reproduit ou utilisé sans le consentement de EXM

| No. | Revisions | Date       | By/Par |
|-----|-----------|------------|--------|
| 1   |           | 07/08/2014 |        |
|     |           |            |        |
|     |           |            |        |
|     |           |            |        |

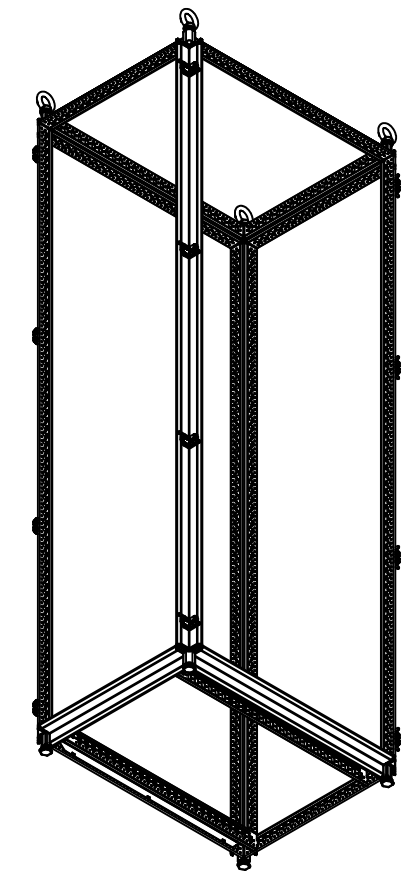

Isometric View

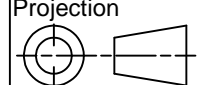

| Qty | Part Number    | Rev | Description                               |
|-----|----------------|-----|---|
| 1   | STK-P-03810R   | 0   | Powder Paint (Iron Grey / Rough Textured) |
| 1   | STK-Q-49065    | 3   | 6500 MXM Inner Panel Slider 800mm         |
| 1   | STK-Q-49065-L  | 3   | 6500 MXM Inner Panel Slider 800mm         |
| 4   | STK-Q-49500    | 3   | M12 Eye Bolt (0.34T)                      |
| 4   | STK-Q-61110    | 0   | M12 Feet Leveler                          |
| 8   | STK-Q-00610    | 1   | M18 x 30.5mm Bolt - Cover                 |
| 4   | STK-Q-47251-20 | 3   | 6500 MX 2000mm Vertical Frame Post Part   |
| 4   | STK-Q-47250-06 | 3   | 6500 MX 600mm Horizontal Frame Post Part  |
| 4   | STK-Q-47250-08 | 3   | 6500 MX 800mm Horizontal Frame Post Part  |
| 8   | STK-Q-49445    | 2   | 6500 MX - Frame Corner Bracket Casting    |
| 16  | STK-K-11001    | 2   | 3 Way Fixed Bracket Kit                   |
|     |                |     |   |
|     |                |     |   |
|     |                |     |   |

|  |                                  |   |
|--|----------------------------------|---|
|  Tél: (450) 979-4373<br>Fax: (450) 979-4626<br><a href="http://www.exmweb.com">www.exmweb.com</a> |                                  | Flatness<br>Aplatissement<br>Max 3.0mm<br>Projection<br> |
| Customer<br>Client   | Date                             |   |
| Drawn By<br>Dessiné Par  | BoxCad: Annie                    | Date 08/04/2013   |
| Material<br>Matière  | 16 Ga Electro-Galvanized (1.4mm) |   |
| Color<br>Couleur   | Iron Grey RAL7011                | Finish<br>Fini<br>Rough Textured  |
| Description  | Detail Rev.                      |   |
| 6500 MX 2000mm x 600mm x 800mm<br>Frame  |                                  |   |
| Part Number<br>Numéro Pièce  | Rev. 1                           | 2   |
| <b>6500MXK200608FR</b>   |                                  | 2   |

Parts List

This drawing is confidential and must not be reproduced or used without the consent of EXM

Ce dessin est confidentiel et ne doit pas être reproduit ou utilisé sans le consentement de EXM



TOP

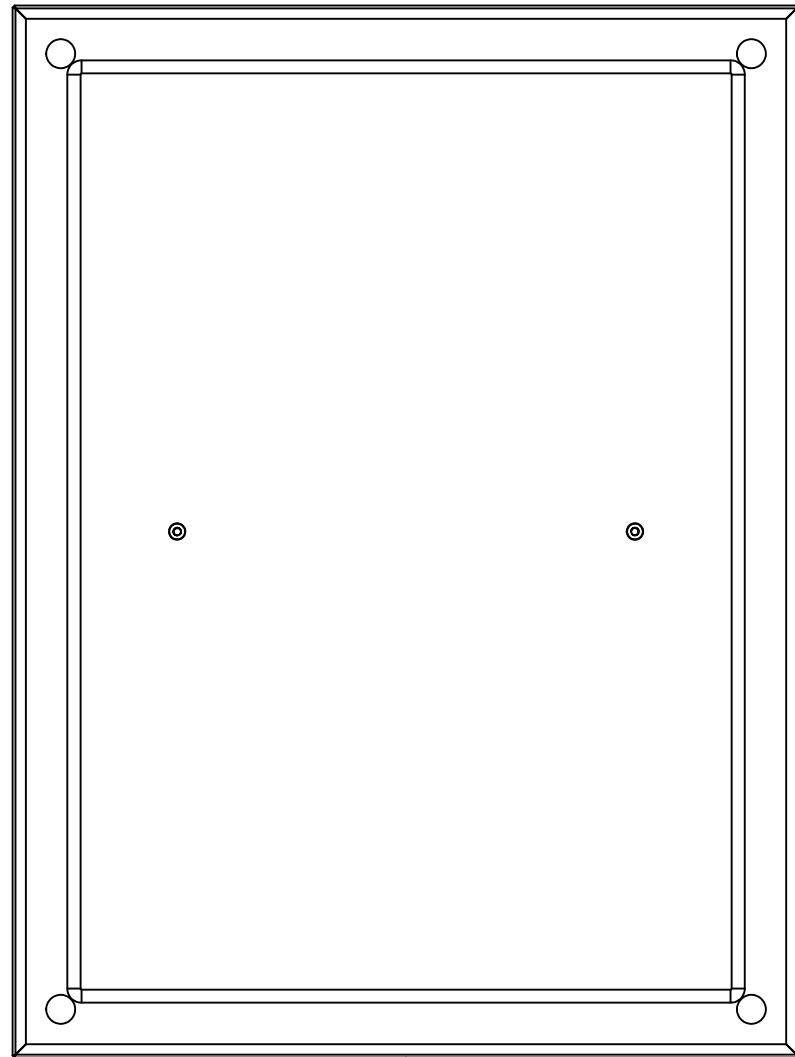

BACK

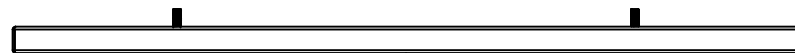

BOTTOM

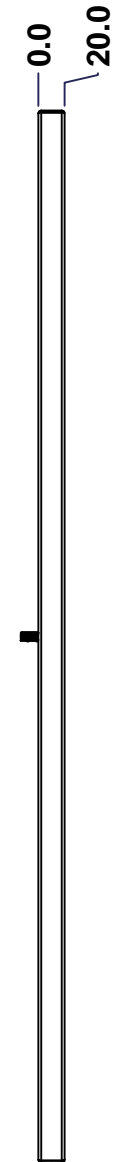

LEFT

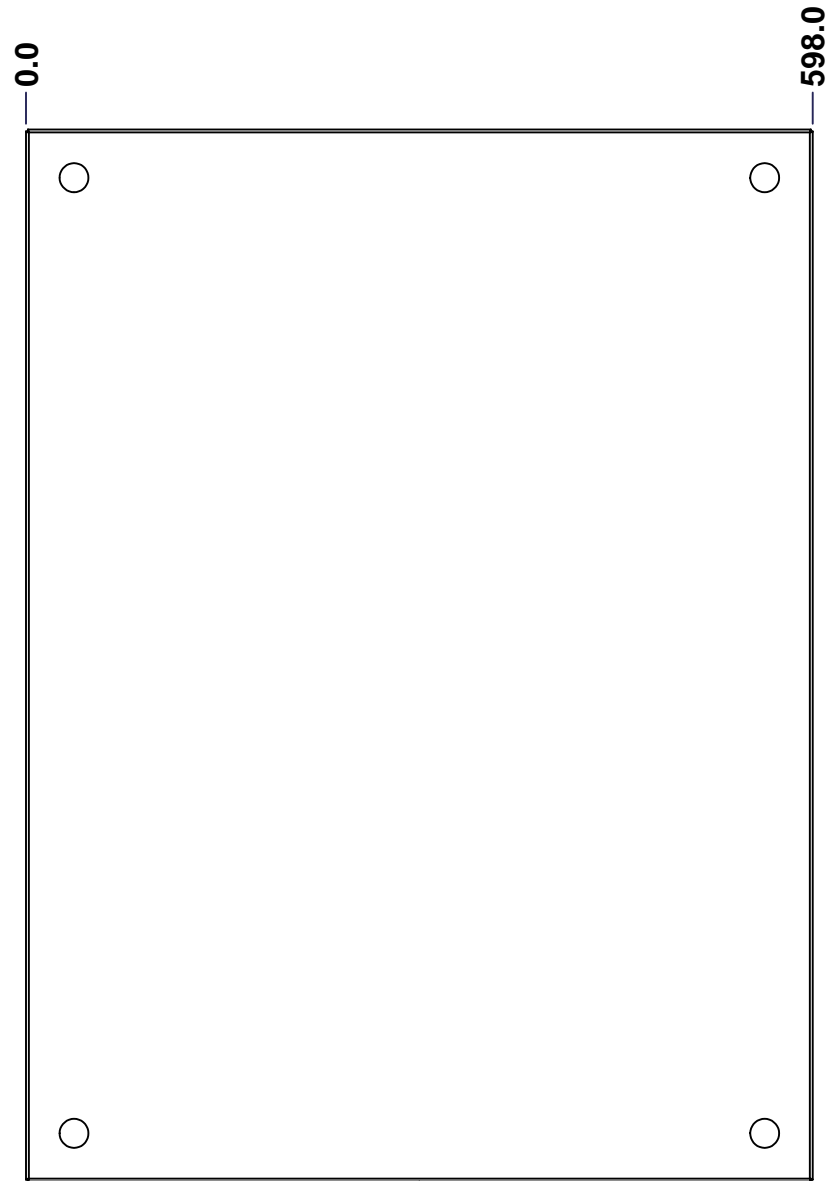

FRONT

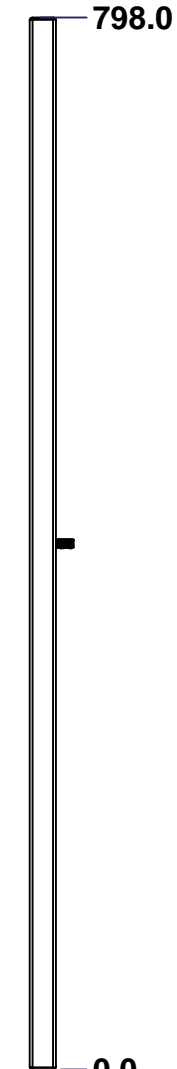

RIGHT

| No. | Revisions | Date       | By/Par |
|-----|-----------|------------|--------|
| 1   |           | 07/08/2014 |        |
|     |           |            |        |
|     |           |            |        |
|     |           |            |        |

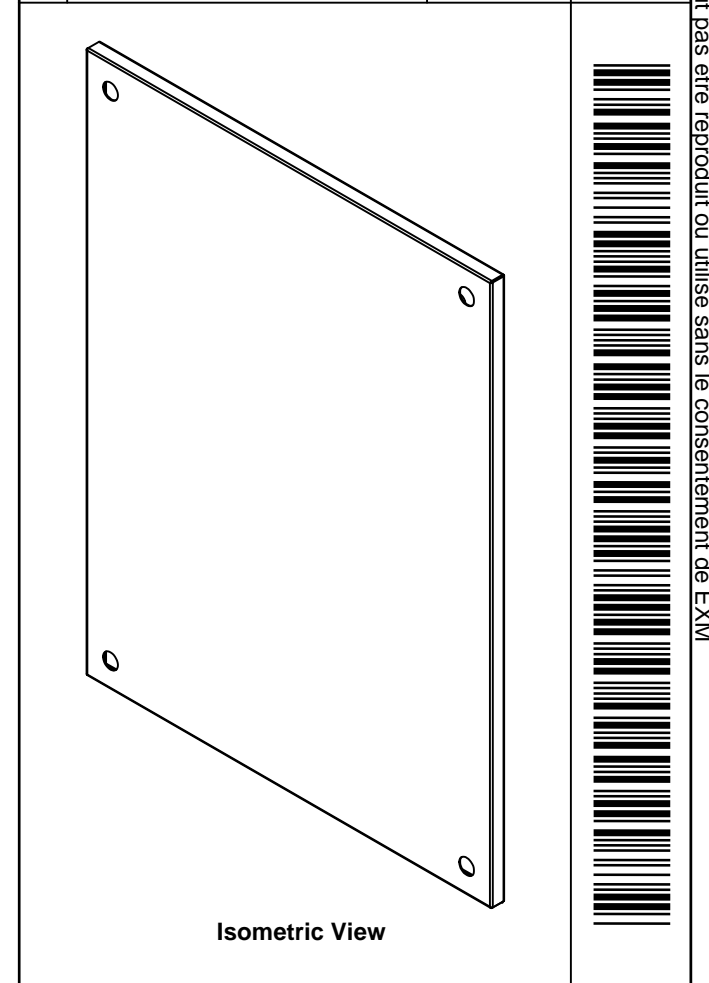

Isometric View

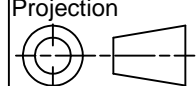
|  |  |   |             |
|--|--|---|-------------|
|  Tél: (450) 979-4373<br>Fax: (450) 979-4626<br><a href="http://www.exmweb.com">www.exmweb.com</a> |  | Flatness<br>Aplatissement<br>Max 3.0mm<br>Projection<br> |             |
| Customer Client  |  | Date  |             |
| Drawn By / Dessiné Par: BoxCad: Annie  |  | Date: 08/04/2013  |             |
| Material / Matière: 16 Ga H.R.P. & O. (1.4mm)  |  |   |             |
| Color / Couleur: Iron Grey RAL7011   |  | Finish / Fini: Rough Textured   |             |
| Description: 6500 MXT 600mm x 800mm Top  |  |   | Detail Rev. |
| Part Number / Numéro Pièce: 6500MXK200608T   |  | Rev. 1  | 3           |

SEE BILL OF MATERIAL ON LAST PAGE

This drawing is confidential and must not be reproduced or used without the consent of EXM

Ce dessin est confidentiel et ne doit pas être reproduit ou utilisé sans le consentement de EXM

| STANDARD FEATURES ARE NOT LISTED IN THIS HOLE TABLE |       |       |                             |
|---|-------|-------|-----------------------------|
| HOLE TABLE - FRONT VIEW (CUSTOM FEATURE ONLY)       |       |       |                             |
| CUT-OUT   | XDIM  | YDIM  | DESCRIPTION                 |
| 1   | 125.0 | 399.0 | GND STUD M6 x 16mm (Inside) |
| 2   | 473.0 | 399.0 | GND STUD M6 x 16mm (Inside) |

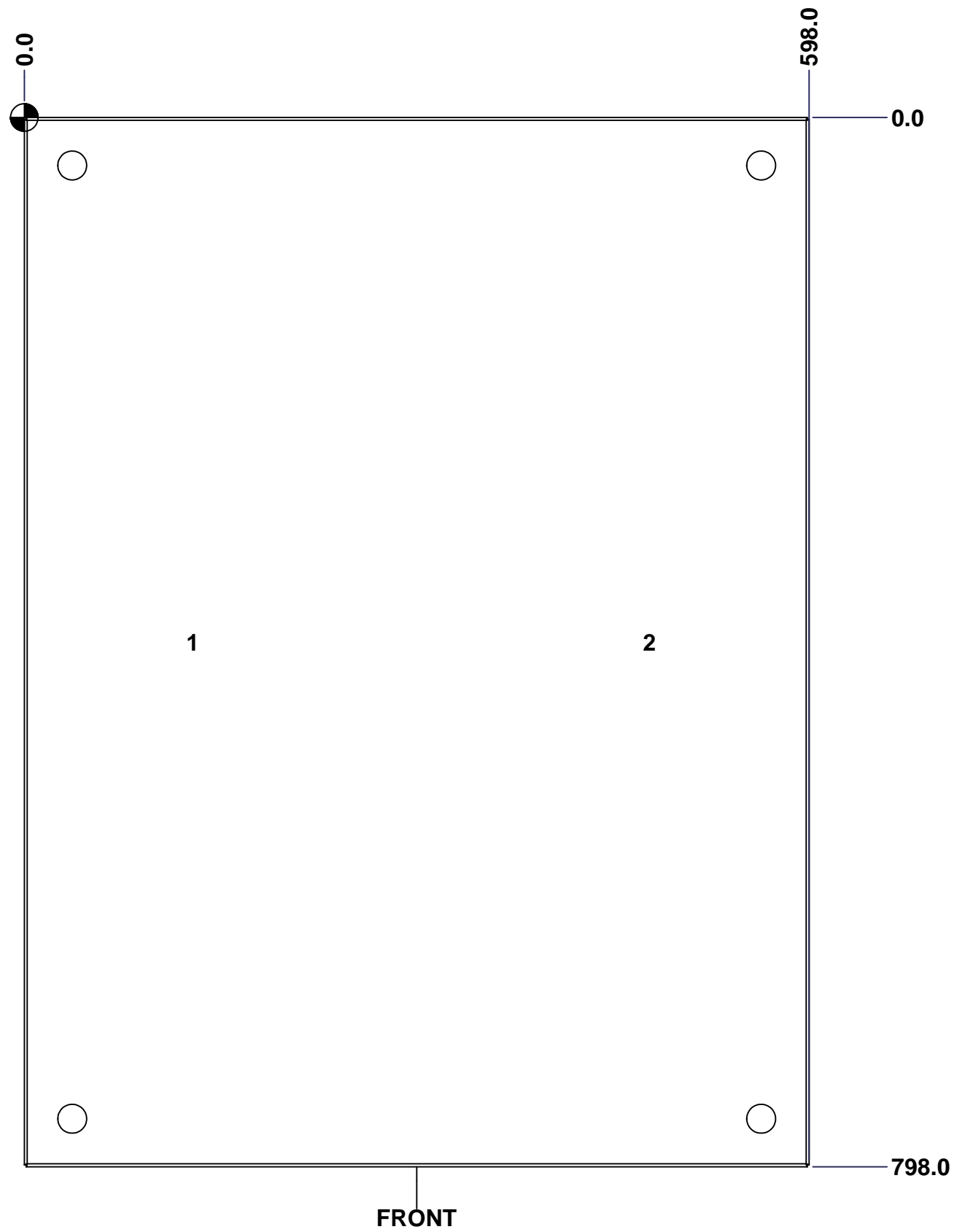



|  |                             |          |
|--|-----------------------------|----------|
|  | Description                 | Status   |
|  | 6500 MXT 600mm x 800mm Top  | (NULL)   |
|  | Part Number<br>Numéro Pièce | Rev.     |
|  | <b>6500MXK200608T</b>       | <b>1</b> |
|  |                             | 2        |
|  |                             | 3        |

This drawing is confidential and must not be reproduced or used without the consent of EXM

Ce dessin est confidentiel et ne doit pas être reproduit ou utilisé sans le consentement de EXM

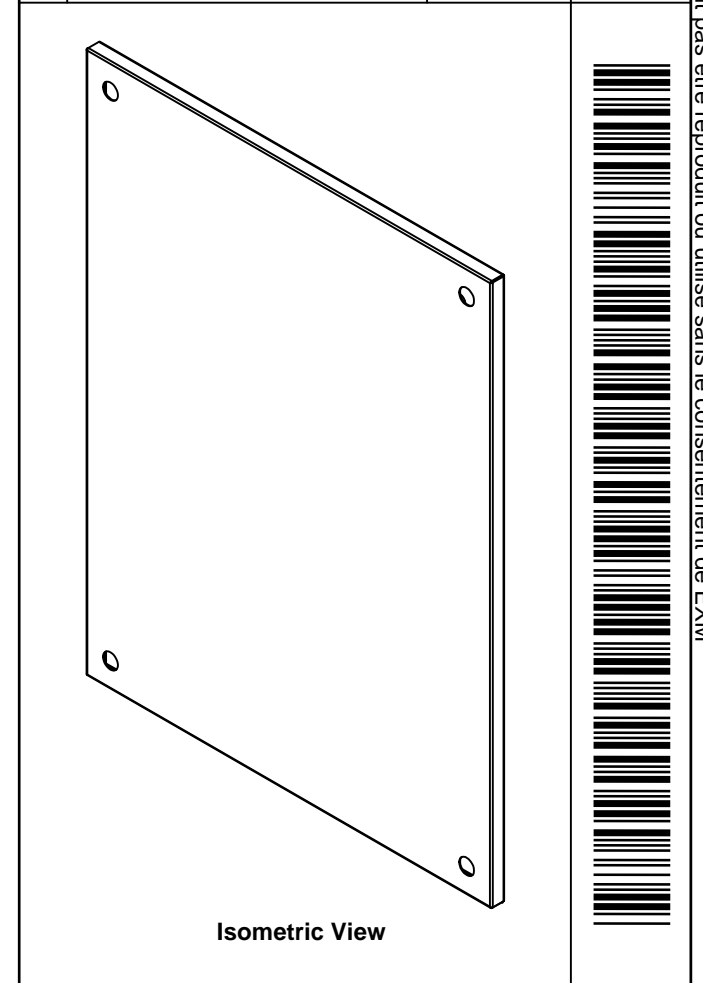
| No. | Revisions | Date       | By/Par |
|-----|-----------|------------|--------|
| 1   |           | 07/08/2014 |        |
|     |           |            |        |
|     |           |            |        |
|     |           |            |        |

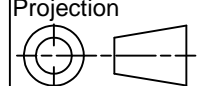

|  |                           |   |
|--|---------------------------|---|
|  Tél: (450) 979-4373<br>Fax: (450) 979-4626<br><a href="http://www.exmweb.com">www.exmweb.com</a> |                           | Flatness<br>Aplatissement<br>Max 3.0mm<br>Projection<br> |
| Customer<br>Client   | Date                      |   |
| Drawn By<br>Dessiné Par  | BoxCad: Annie             | Date 08/04/2013   |
| Material<br>Matière  | 16 Ga H.R.P. & O. (1.4mm) |   |
| Color<br>Couleur   | Iron Grey RAL7011         | Finish<br>Fini<br>Rough Textured  |
| Description  | Detail Rev.               |   |
| 6500 MXT 600mm x 800mm Top   |                           |   |
| Part Number<br>Numéro Pièce  | Rev.                      | 3   |
| <b>6500MXK200608T</b>  | <b>1</b>                  | <b>3</b>  |

| Qty        | Part Number      | Rev   | Description                               |
|------------|------------------|-------|---|
| 1          | STK-P-03810R     | 0     | Powder Paint (Iron Grey / Rough Textured) |
| 2          | STK-Q-16080      | 0.1.1 | M6 x 16mm Ground Stud                     |
| 1          | 6500MXK200608TG  | 1     | 6500 MXT 600mm x 800mm Top Gasket         |
| 1          | 6500MXK200608T-P | 1     | 6500 MXT 600mm x 800mm Top Part           |
| Parts List |                  |       |   |

This drawing is confidential and must not be reproduced or used without the consent of EXM

Ce dessin est confidentiel et ne doit pas être reproduit ou utilisé sans le consentement de EXM

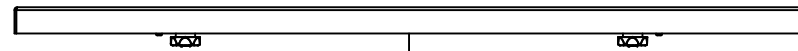

TOP

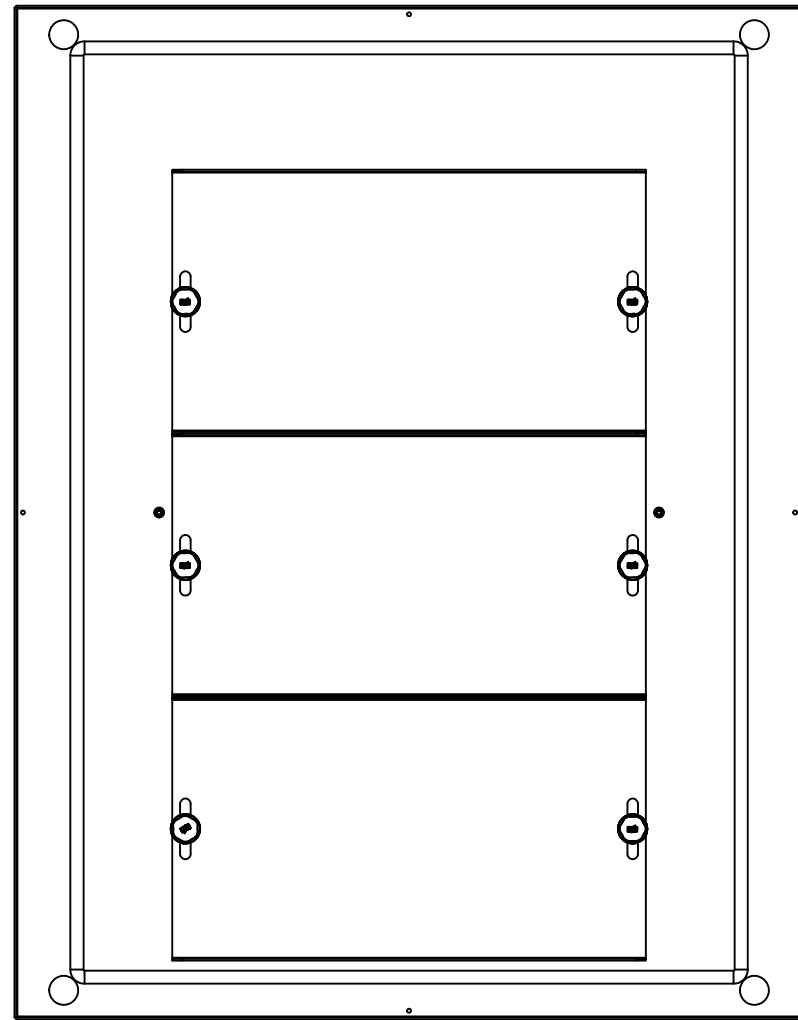

BACK

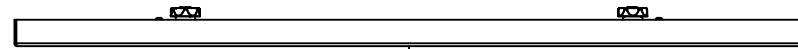

BOTTOM

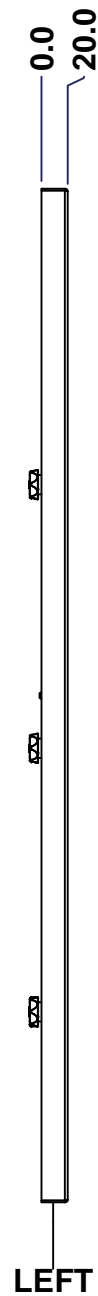

LEFT

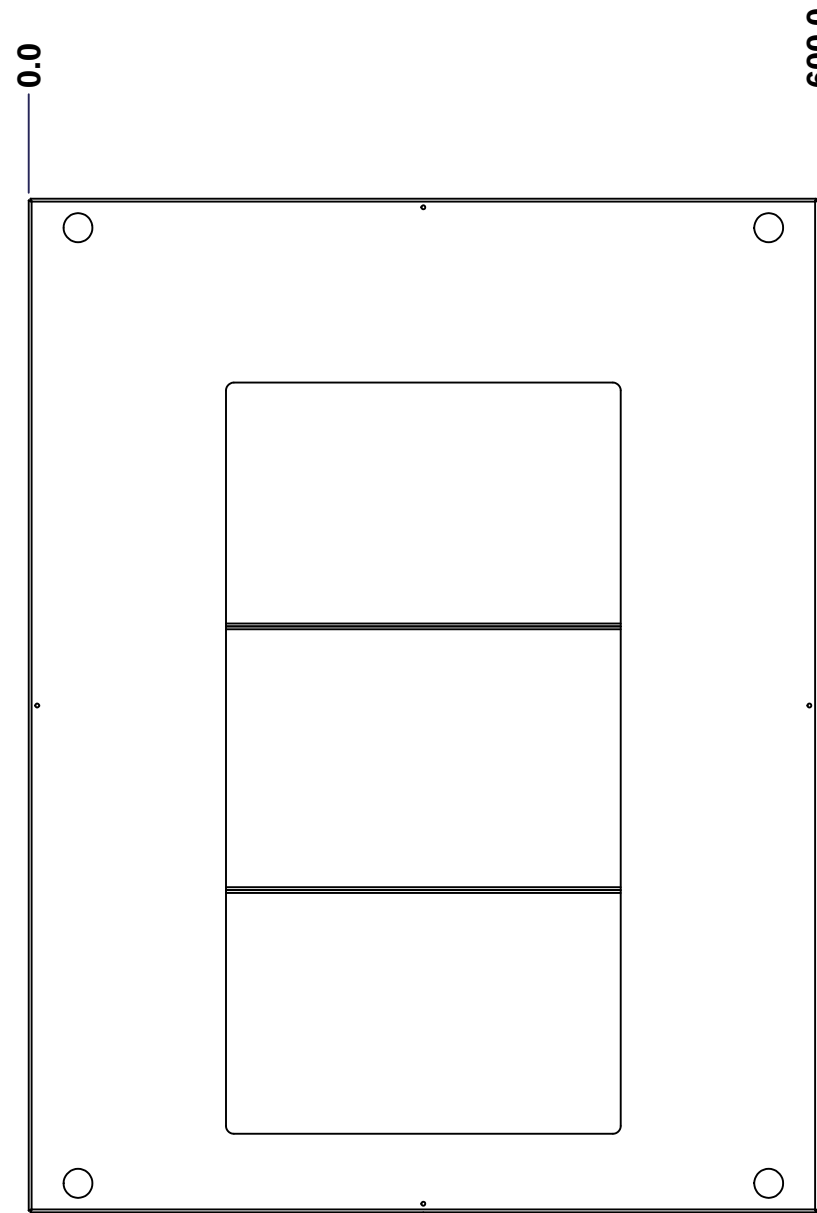

FRONT

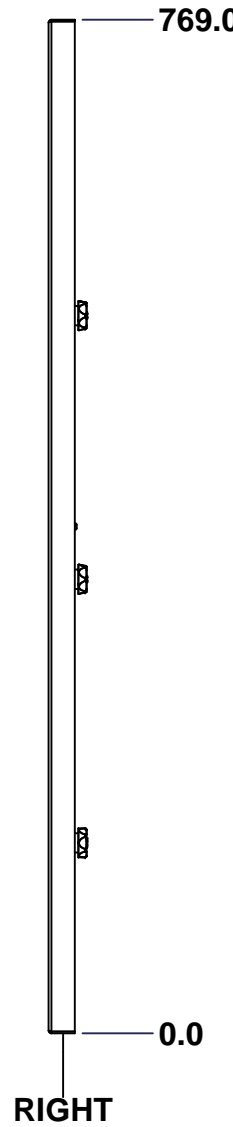

RIGHT

| No. | Revisions | Date       | By/Par |
|-----|-----------|------------|--------|
| 1   |           | 07/08/2014 |        |
|     |           |            |        |
|     |           |            |        |
|     |           |            |        |

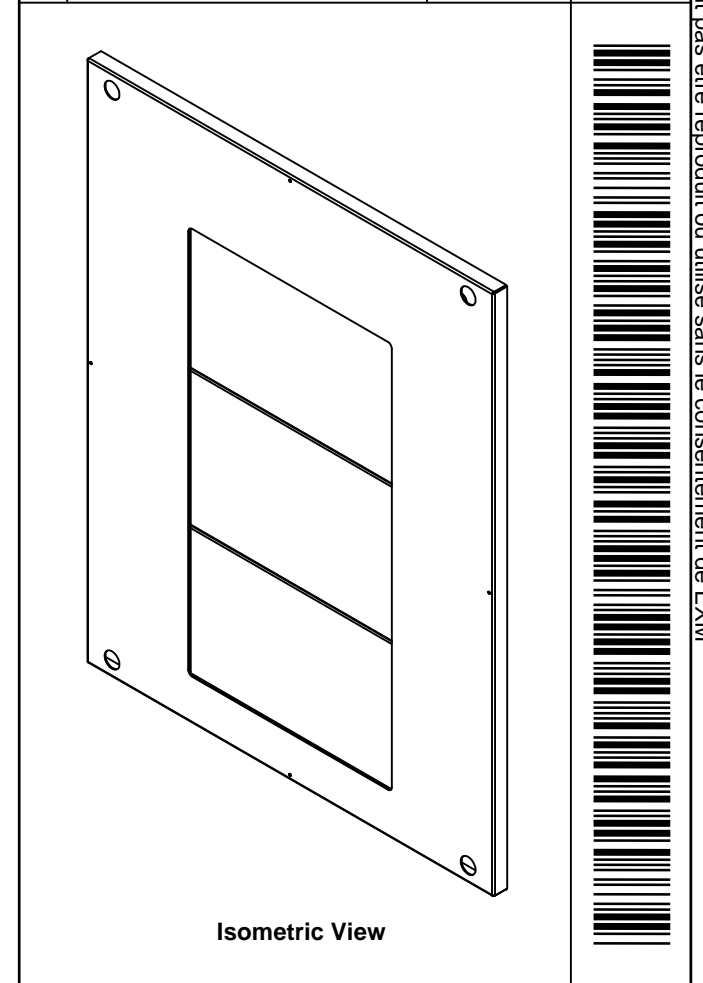

Isometric View

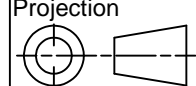
|  |  |   |   |
|--|--|---|---|
|  Tél: (450) 979-4373<br>Fax: (450) 979-4626<br><a href="http://www.exmweb.com">www.exmweb.com</a> |  | Flatness<br>Aplatissement<br>Max 3.0mm<br>Projection<br> |   |
| Customer Client  |  | Date  |   |
| Drawn By / Dessiné Par: BoxCad: Annie  |  | Date: 08/04/2013  |   |
| Material / Matière: 16 Ga H.R.P. & O. (1.4mm)  |  |   |   |
| Color / Couleur: Iron Grey RAL7011   |  | Finish / Fini: Rough Textured   |   |
| Description: 6500 MXB 600mm x 800mm Bottom   |  | Detail Rev.   |   |
| Part Number / Numéro Pièce: 6500MXK200608BT  |  | Rev. 1  | 3 |

SEE BILL OF MATERIAL ON LAST PAGE



This drawing is confidential and must not be reproduced or used without the consent of EXM

Ce dessin est confidentiel et ne doit pas être reproduit ou utilisé sans le consentement de EXM

**STANDARD FEATURES ARE NOT LISTED IN THIS HOLE TABLE**

**HOLE TABLE - FRONT VIEW (CUSTOM FEATURE ONLY)**

| CUT-OUT | XDIM  | YDIM  | DESCRIPTION                 |
|---------|-------|-------|-----------------------------|
| 1       | 110.0 | 384.5 | GND STUD M6 x 16mm (Inside) |
| 2       | 490.0 | 384.5 | GND STUD M6 x 16mm (Inside) |
| 3       | 130.0 | 544.5 | GP STUD M6 x 10mm (Inside)  |
| 4       | 470.0 | 544.5 | GP STUD M6 x 10mm (Inside)  |
| 5       | 130.0 | 344.5 | GP STUD M6 x 10mm (Inside)  |
| 6       | 470.0 | 344.5 | GP STUD M6 x 10mm (Inside)  |
| 7       | 130.0 | 144.5 | GP STUD M6 x 10mm (Inside)  |
| 8       | 470.0 | 144.5 | GP STUD M6 x 10mm (Inside)  |

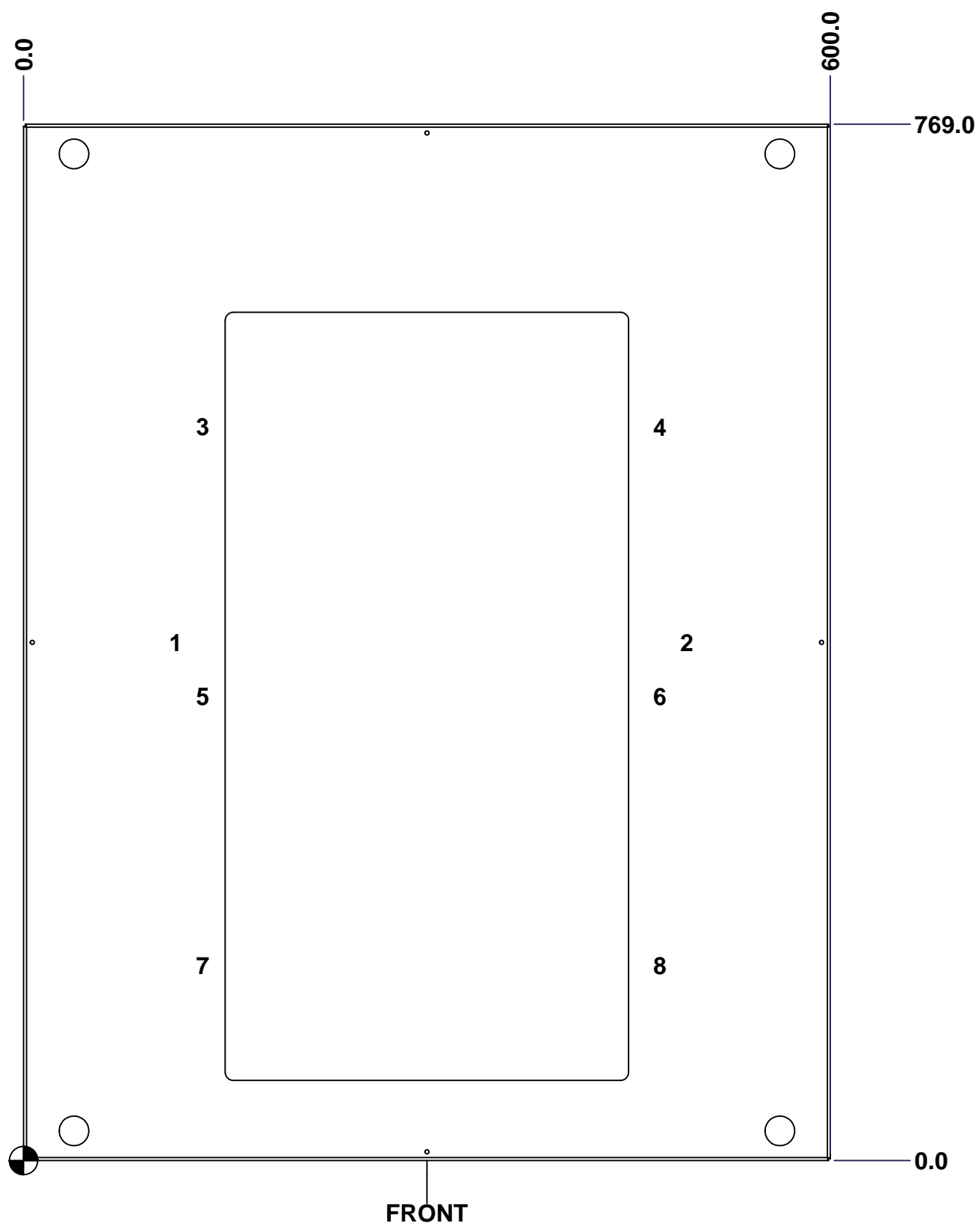

FRONT

|   |                               |        |
|---|-------------------------------|--------|
|   | Description                   | Status |
|   | 6500 MXB 600mm x 800mm Bottom | (NULL) |
| Part Number<br>Numéro Pièce<br><b>6500MXK200608BT</b> | Rev.                          | 2      |
|   | <b>1</b>                      | 3      |

This drawing is confidential and must not be reproduced or used without the consent of EXM

Ce dessin est confidentiel et ne doit pas être reproduit ou utilisé sans le consentement de EXM

| No. | Revisions | Date       | By/Par |
|-----|-----------|------------|--------|
| 1   |           | 07/08/2014 |        |
|     |           |            |        |
|     |           |            |        |
|     |           |            |        |

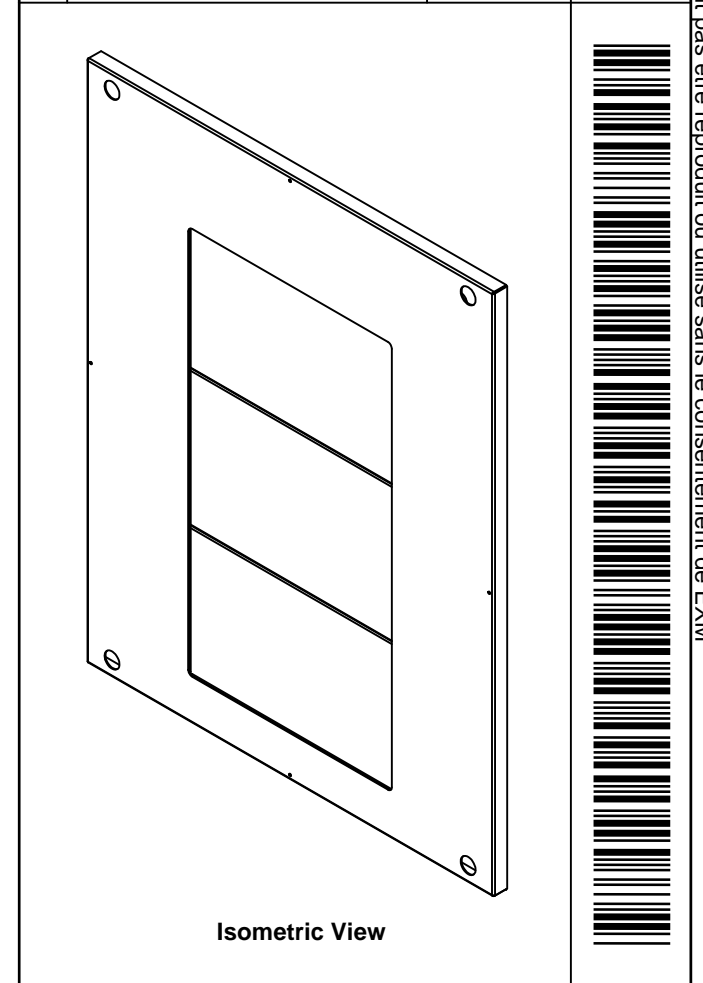

|  |  |  |             |
|--|--|--|-------------|
| Tél: (450) 979-4373<br>Fax: (450) 979-4626<br><a href="http://www.exmweb.com">www.exmweb.com</a> |  | Flatness<br>Aplatissement<br>Max 3.0mm |             |
|  |  | Projection<br>                         |             |
| Customer Client  |  | Date                                   |             |
| Drawn By<br>Dessiné Par BoxCad: Annie  |  | Date 08/04/2013                        |             |
| Material<br>Matière 16 Ga H.R.P. & O. (1.4mm)  |  |  |             |
| Color<br>Couleur Iron Grey RAL7011   |  | Finish<br>Fini Rough Textured          |             |
| Description<br>6500 MXB 600mm x 800mm Bottom   |  |  | Detail Rev. |
| Part Number<br>Numéro Pièce <b>6500MXK200608BT</b>   |  | Rev. <b>1</b>                          | 3           |

| Qty        | Part Number          | Rev | Description                                      |
|------------|----------------------|-----|--|
| 1          | STK-P-03810R         | 0   | Powder Paint (Iron Grey / Rough Textured)        |
| 6          | STK-Q-06001          | 0   | Mtrx - Gland Plate M6 Plastic Thumb Nut          |
| 2          | STK-Q-16055          | 1   | M6 x 18mm Stud (No Paint Cap Required)           |
| 3          | 6500MXK200608GP200-P | 1   | 6500 MXB 600mm Gland Plate Part (200mm)          |
| 6          | STK-Q-16031          | 0   | M6 x 10mm Stud (No Paint Cap Required)           |
| 1          | 6500MXK200608BTGPG   | 1   | 6500 MXB 600mm x 800mm Bottom Gland Plate Gasket |
| 1          | 6500MXK200608BTG     | 1   | 6500 MXB 600mm x 800mm Bottom Gasket             |
| 1          | 6500MXK200608BT-P    | 1   | 6500 MXB 600mm x 800mm Bottom Part               |
| Parts List |                      |     |  |

This drawing is confidential and must not be reproduced or used without the consent of EXM

Ce dessin est confidentiel et ne doit pas être reproduit ou utilisé sans le consentement de EXM

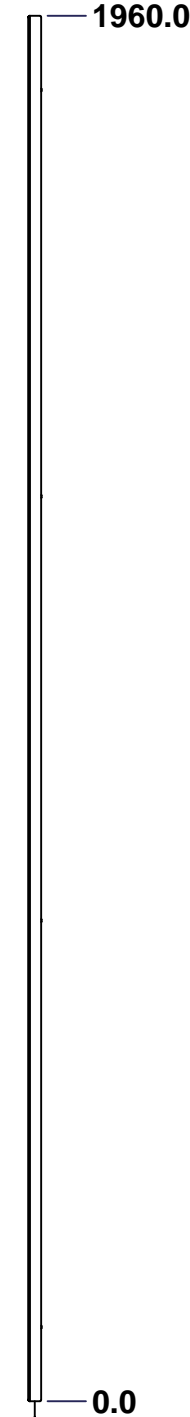
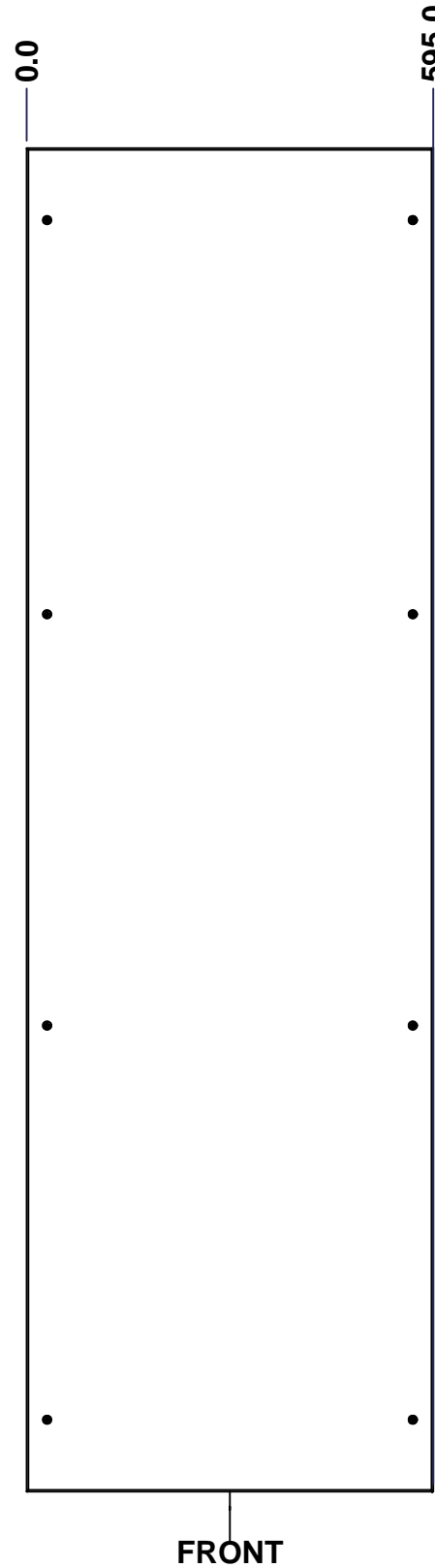
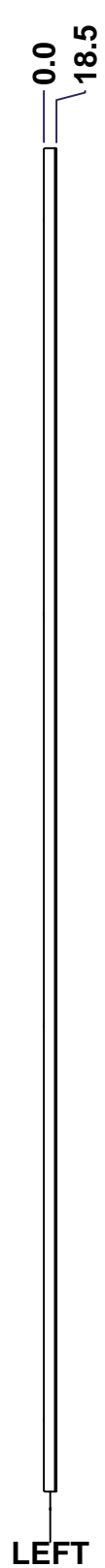
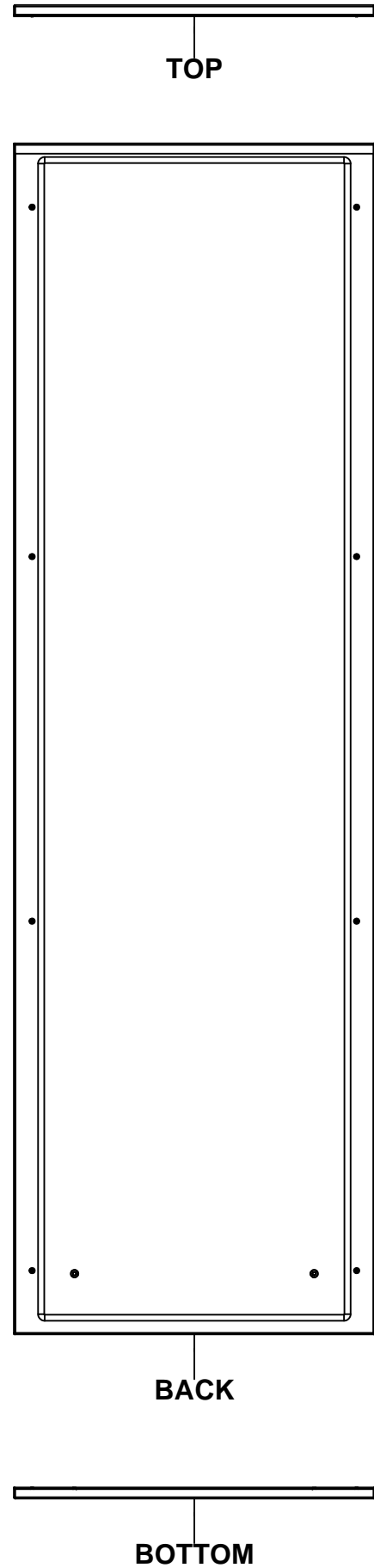

| No. | Revisions | Date       | By/Par |
|-----|-----------|------------|--------|
| 1   |           | 07/08/2014 |        |
|     |           |            |        |
|     |           |            |        |
|     |           |            |        |

**Isometric View**

|  |  |                               |             |
|--|--|-------------------------------|-------------|
| Tél: (450) 979-4373<br>Fax: (450) 979-4626<br><a href="http://www.exmweb.com">www.exmweb.com</a> |  | Flatness<br>Aplatissement     |             |
|  |  | Max 3.0mm                     |             |
| Customer<br>Client   |  | Date                          |             |
| Drawn By<br>Dessiné Par BoxCad: Annie  |  | Date 08/04/2013               |             |
| Material<br>Matière 14 Ga H.R.P. & O. (1.7mm)  |  |                               |             |
| Color<br>Couleur Light Grey RAL7035  |  | Finish<br>Fini Rough Textured |             |
| Description<br>6500 MXR 2000mm x 600mm Back  |  |                               | Detail Rev. |
| Part Number<br>Numéro Pièce <b>6500MXK200608B</b>  |  | Rev. <b>1</b>                 | 1 / 3       |

**SEE BILL OF MATERIAL ON LAST PAGE**

This drawing is confidential and must not be reproduced or used without the consent of EXM

Ce dessin est confidentiel et ne doit pas être reproduit ou utilisé sans le consentement de EXM

| STANDARD FEATURES ARE NOT LISTED IN THIS HOLE TABLE |       |       |                             |
|---|-------|-------|-----------------------------|
| HOLE TABLE - FRONT VIEW (CUSTOM FEATURE ONLY)       |       |       |                             |
| CUT-OUT   | XDIM  | YDIM  | DESCRIPTION                 |
| 1   | 100.0 | 100.0 | GND STUD M6 x 16mm (Inside) |
| 2   | 495.0 | 100.0 | GND STUD M6 x 16mm (Inside) |

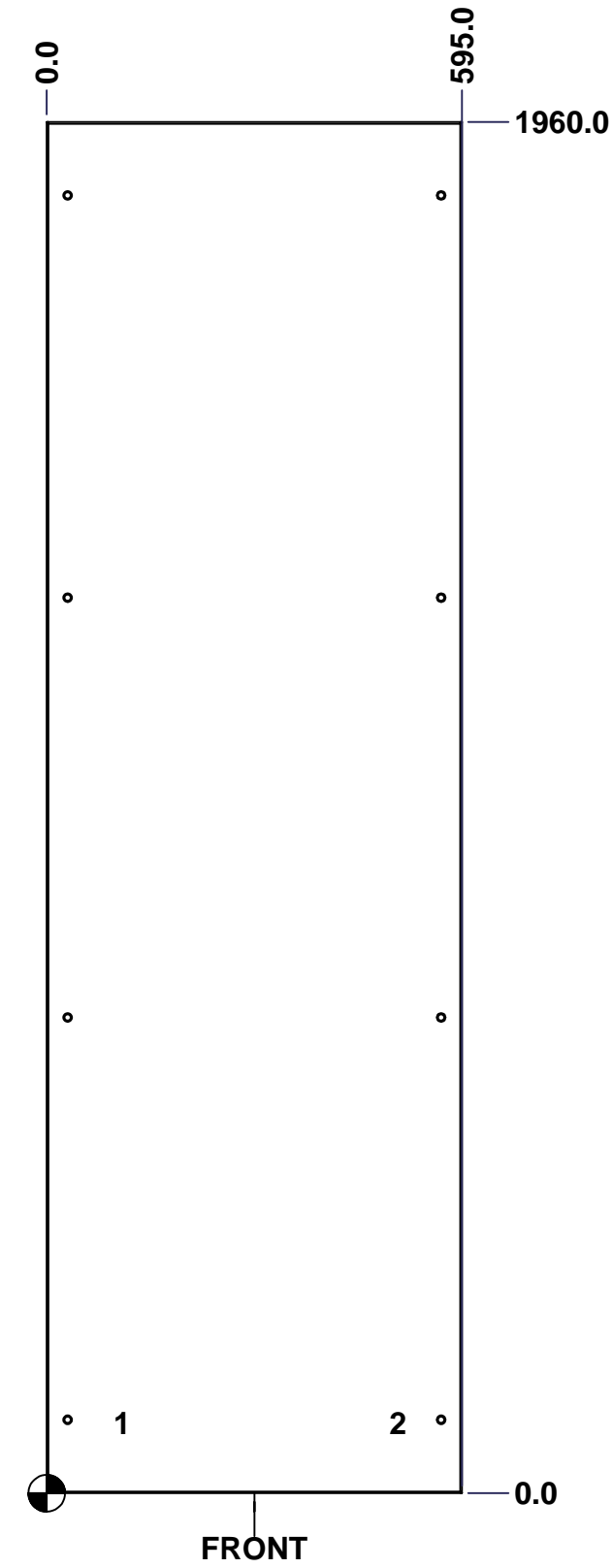



|  |                              |          |        |
|--|------------------------------|----------|--------|
|  | Description                  | Status   |        |
|  | 6500 MXR 2000mm x 600mm Back | (NULL)   |        |
|  | Part Number<br>Numéro Pièce  | Rev.     |        |
|  | <b>6500MXK200608B</b>        | <b>1</b> | 2<br>3 |

This drawing is confidential and must not be reproduced or used without the consent of EXM

Ce dessin est confidentiel et ne doit pas être reproduit ou utilisé sans le consentement de EXM

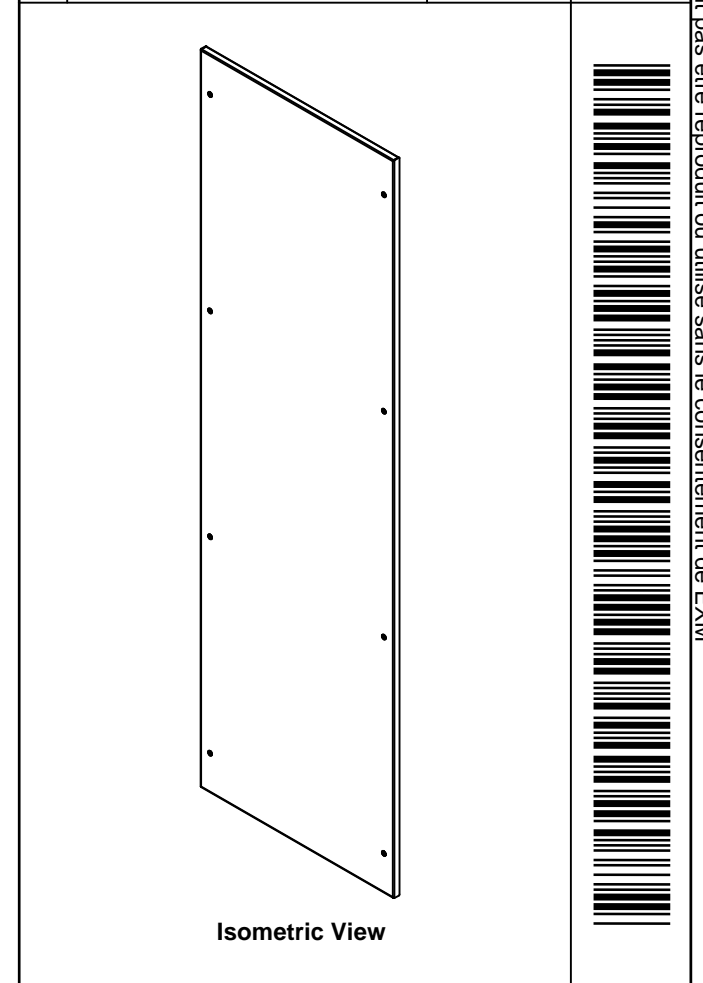
| No. | Revisions | Date       | By/Par |
|-----|-----------|------------|--------|
| 1   |           | 07/08/2014 |        |
|     |           |            |        |
|     |           |            |        |
|     |           |            |        |
|     |           |            |        |

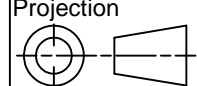

|  |                           |   |
|--|---------------------------|---|
|  Tél: (450) 979-4373<br>Fax: (450) 979-4626<br><a href="http://www.exmweb.com">www.exmweb.com</a> |                           | Flatness<br>Aplatissement<br>Max 3.0mm<br>Projection<br> |
| Customer<br>Client   | Date                      |   |
| Drawn By<br>Dessiné Par  | BoxCad: Annie             | Date 08/04/2013   |
| Material<br>Matière  | 14 Ga H.R.P. & O. (1.7mm) |   |
| Color<br>Couleur   | Light Grey RAL7035        | Finish<br>Fini<br>Rough Textured  |
| Description  | Detail Rev.               |   |
| 6500 MXR 2000mm x 600mm Back   |                           |   |
| Part Number<br>Numéro Pièce  | Rev. 1                    | 3   |
| <b>6500MXK200608B</b>  |                           | <b>3</b>  |

| Qty        | Part Number      | Rev   | Description                                |
|------------|------------------|-------|--|
| 1          | STK-P-03820R     | 0     | Powder Paint (Light Grey / Rough Textured) |
| 8          | STK-Q-03072      | 2     | M6 x 17mm Phillips Flat Head Screw         |
| 2          | STK-Q-16080      | 0.1.1 | M6 x 16mm Ground Stud                      |
| 1          | 6500MXK200608BG  | 1     | 6500 MXR 2000mm x 600mm Back Gasket        |
| 1          | 6500MXK200608B-P | 1     | 6500 MXR 2000mm x 600mm Back Part          |
| Parts List |                  |       |  |

This drawing is confidential and must not be reproduced or used without the consent of EXM

Ce dessin est confidentiel et ne doit pas être reproduit ou utilisé sans le consentement de EXM

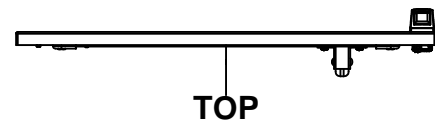

TOP

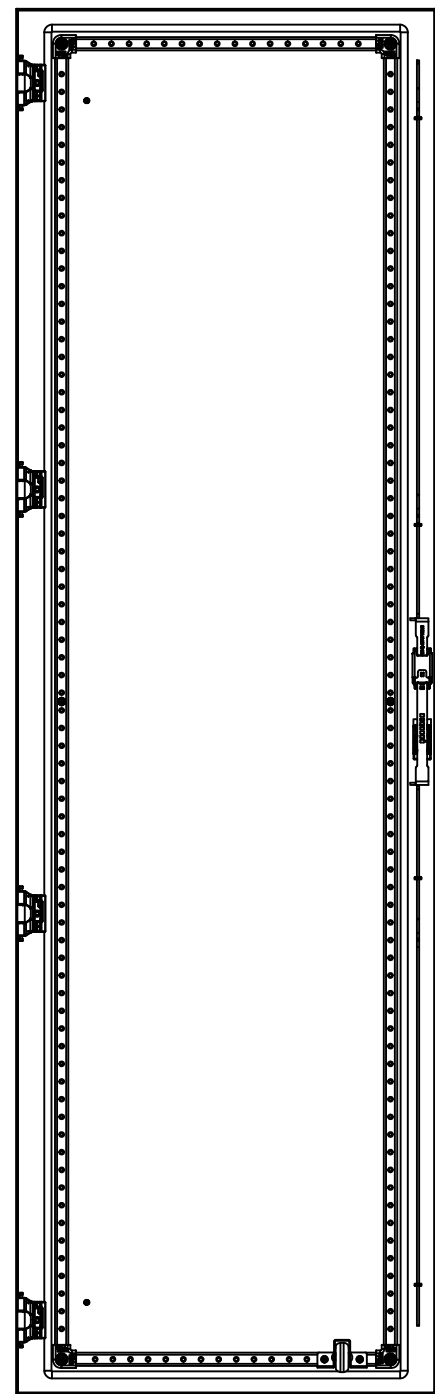

BACK

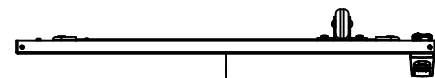

BOTTOM

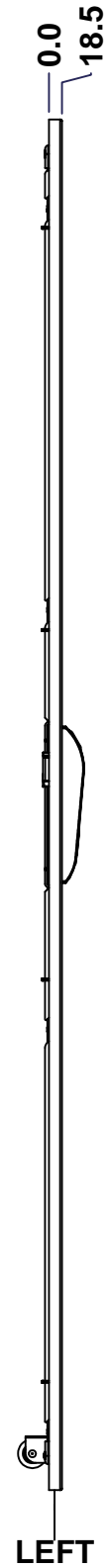

LEFT

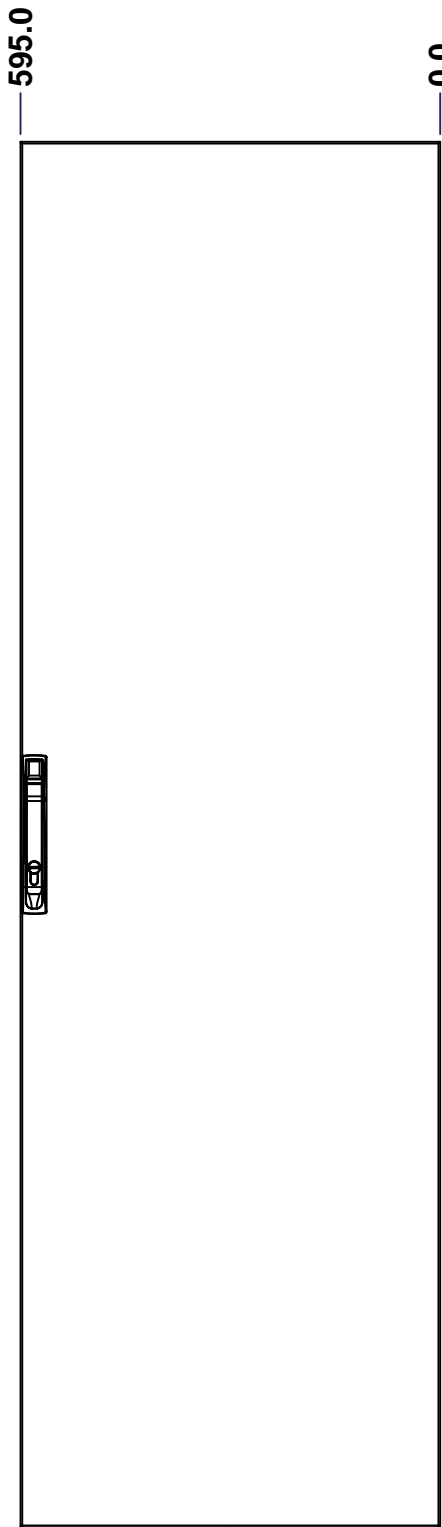

FRONT

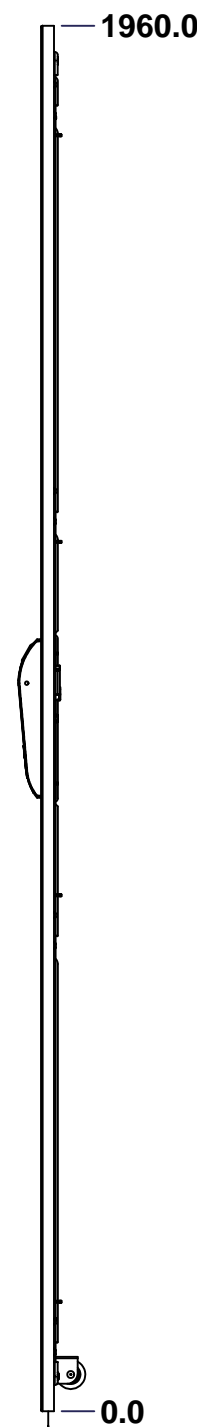

RIGHT

| No. | Revisions | Date       | By/Par |
|-----|-----------|------------|--------|
| 1   |           | 07/08/2014 |        |
|     |           |            |        |
|     |           |            |        |
|     |           |            |        |

Isometric View

|  |  |                               |       |
|--|--|-------------------------------|-------|
| Tél: (450) 979-4373<br>Fax: (450) 979-4626<br><a href="http://www.exmweb.com">www.exmweb.com</a> |  | Flatness<br>Aplatissement     |       |
|  |  | Max 3.0mm                     |       |
| Customer<br>Client   |  | Projection                    |       |
| Date   |  |                               |       |
| Drawn By<br>Dessiné Par BoxCad: Annie  |  | Date 08/04/2013               |       |
| Material<br>Matière 14 Ga H.R.P. & O. (1.7mm)  |  |                               |       |
| Color<br>Couleur Light Grey RAL7035  |  | Finish<br>Fini Rough Textured |       |
| Description<br>6500 MXD 2000mm x 600mm Front   |  | Detail Rev.                   |       |
| Part Number<br>Numéro Pièce <b>6500MXK200608F</b>  |  | Rev. <b>1</b>                 | 1 / 3 |

SEE BILL OF MATERIAL ON LAST PAGE

This drawing is confidential and must not be reproduced or used without the consent of EXM

Ce dessin est confidentiel et ne doit pas être reproduit ou utilisé sans le consentement de EXM

**STANDARD FEATURES ARE NOT LISTED IN THIS HOLE TABLE**

**HOLE TABLE - FRONT VIEW (CUSTOM FEATURE ONLY)**

| CUT-OUT | XDIM  | YDIM   | DESCRIPTION                    |
|---------|-------|--------|--------------------------------|
| 1       | 100.0 | 130.0  | GND STUD M6 x 16mm (Inside)    |
| 2       | 100.0 | 1830.0 | GND STUD M6 x 16mm (Inside)    |
| 3       | 64.5  | 49.5   | STIFF. STUD M6 x 18mm (Inside) |
| 4       | 64.5  | 980.0  | STIFF. STUD M6 x 18mm (Inside) |
| 5       | 64.5  | 1910.5 | STIFF. STUD M6 x 18mm (Inside) |
| 6       | 530.5 | 49.5   | STIFF. STUD M6 x 18mm (Inside) |
| 7       | 530.5 | 980.0  | STIFF. STUD M6 x 18mm (Inside) |
| 8       | 530.5 | 1910.5 | STIFF. STUD M6 x 18mm (Inside) |
| 9       | 569.5 | 155.0  | CLOSING BAR GUIDE (Inside)     |
| 10      | 569.5 | 1805.0 | CLOSING BAR GUIDE (Inside)     |
| 11      | 569.5 | 730.0  | CLOSING BAR GUIDE (Inside)     |
| 12      | 569.5 | 1230.0 | CLOSING BAR GUIDE (Inside)     |

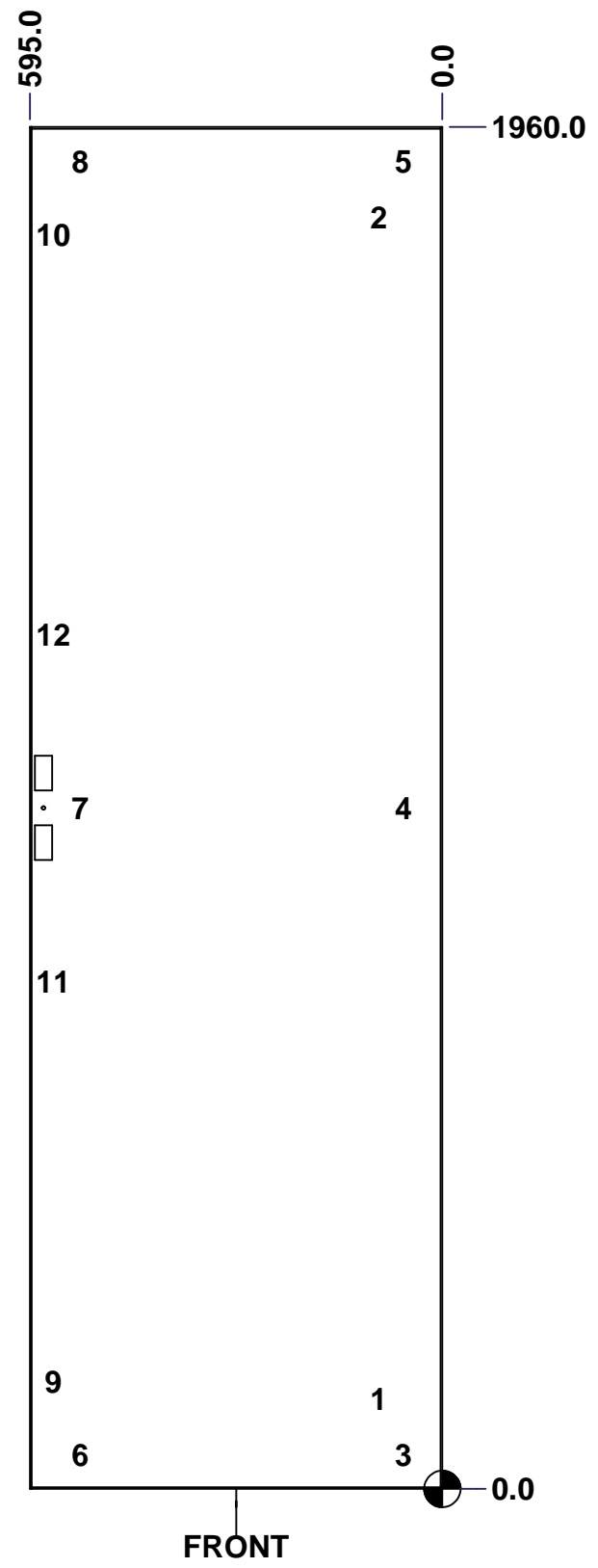

FRONT

|  |                               |          |        |
|--|-------------------------------|----------|--------|
|  | Description                   | Status   |        |
|  | 6500 MXD 2000mm x 600mm Front | (NULL)   |        |
|  | Part Number<br>Numéro Pièce   | Rev.     |        |
|  | <b>6500MXK200608F</b>         | <b>1</b> | 2<br>3 |

This drawing is confidential and must not be reproduced or used without the consent of EXM

Ce dessin est confidentiel et ne doit pas être reproduit ou utilisé sans le consentement de EXM

| No. | Revisions | Date       | By/Par |
|-----|-----------|------------|--------|
| 1   |           | 07/08/2014 |        |
|     |           |            |        |
|     |           |            |        |
|     |           |            |        |

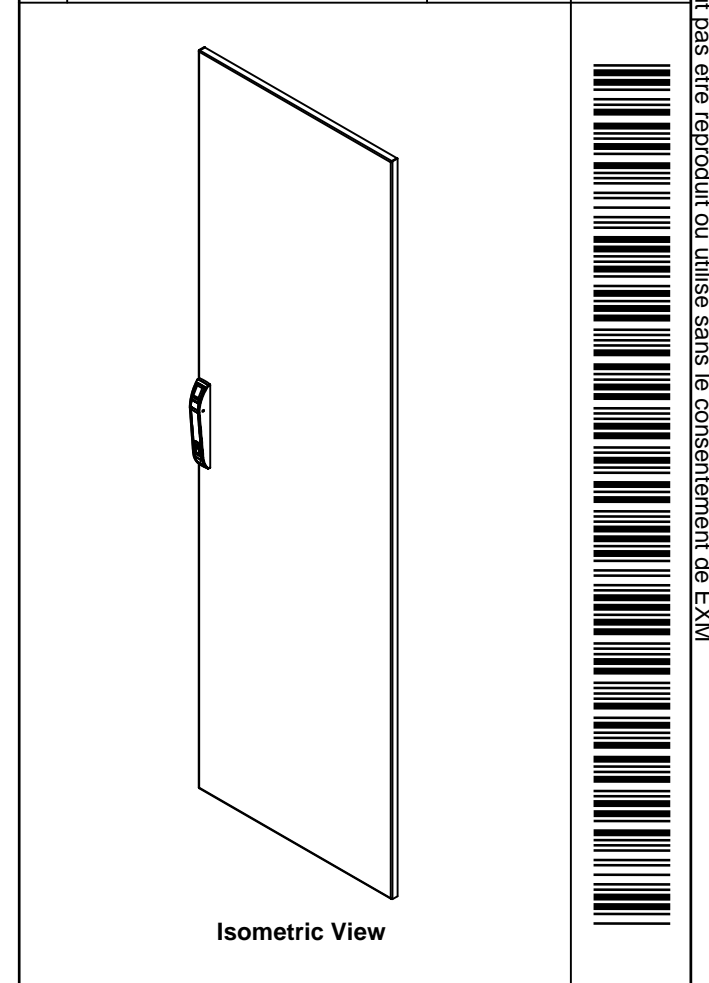

|            |                  |     |  |
|------------|------------------|-----|--|
| 1          | STK-P-03820R     | 0   | Powder Paint (Light Grey / Rough Textured) |
| 1          | 6500MXSRK        | 1   | 6500 MXRSK Door Support Roller             |
| 4          | STK-Q-78022      | 0   | Mtrx Closing Bar Slider                    |
| 1          | STK-Q-45746-20   | 1   | 6500 MXD - Lock Door Closing Bar           |
| 4          | STK-Q-33105      | 4   | 5412 ESBU Buttable Hinge (Cover Part)      |
| 1          | STK-Q-45729-20   | 2   | 6500 MXD - Lock Door Top Closing Bar       |
| 1          | 886PHD-S         | 4   | Euroform Pull Handle Kit                   |
| 8          | STK-Q-16055      | 1   | M6 x 18mm Stud (No Paint Cap Required)     |
| 1          | 6500MXK200608DS1 | 5   | 6500 MX 2000mm x 600mm Door Stiffener      |
| 1          | 6500MXK200608FG  | 1   | 6500 MXD 2000mm x 600mm Front Gasket       |
| 1          | 6500MXK200608F-P | 1   | 6500 MXD 2000mm x 600mm Front Part         |
| 4          | STK-K-06811      | 1   | 6500 MX - Hinge Assy                       |
| Qty        | Part Number      | Rev | Description                                |
| Parts List |                  |     |  |

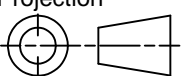
|  |                           |   |
|--|---------------------------|---|
|  Tél: (450) 979-4373<br>Fax: (450) 979-4626<br><a href="http://www.exmweb.com">www.exmweb.com</a> |                           | Flatness<br>Aplatissement<br>Max 3.0mm<br>Projection<br> |
| Customer Client  | Date                      |   |
| Drawn By<br>Dessiné Par  | BoxCad: Annie             | Date 08/04/2013   |
| Material<br>Matière  | 14 Ga H.R.P. & O. (1.7mm) |   |
| Color<br>Couleur   | Light Grey RAL7035        | Finish<br>Fini  |
|  |                           | Rough Textured  |
| Description  | Detail Rev.               |   |
| 6500 MXD 2000mm x 600mm Front  |                           |   |
| Part Number<br>Numéro Pièce  | Rev.                      | 3   |
| <b>6500MXK200608F</b>  | <b>1</b>                  | <b>3</b>  |



This drawing is confidential and must not be reproduced or used without the consent of EXM

Ce dessin est confidentiel et ne doit pas être reproduit ou utilisé sans le consentement de EXM

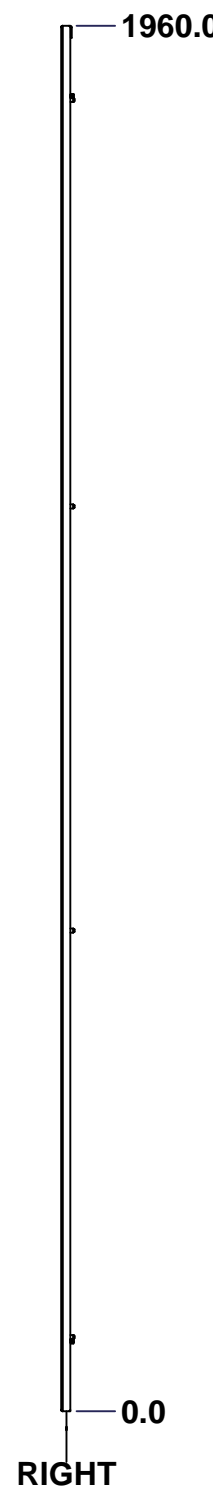
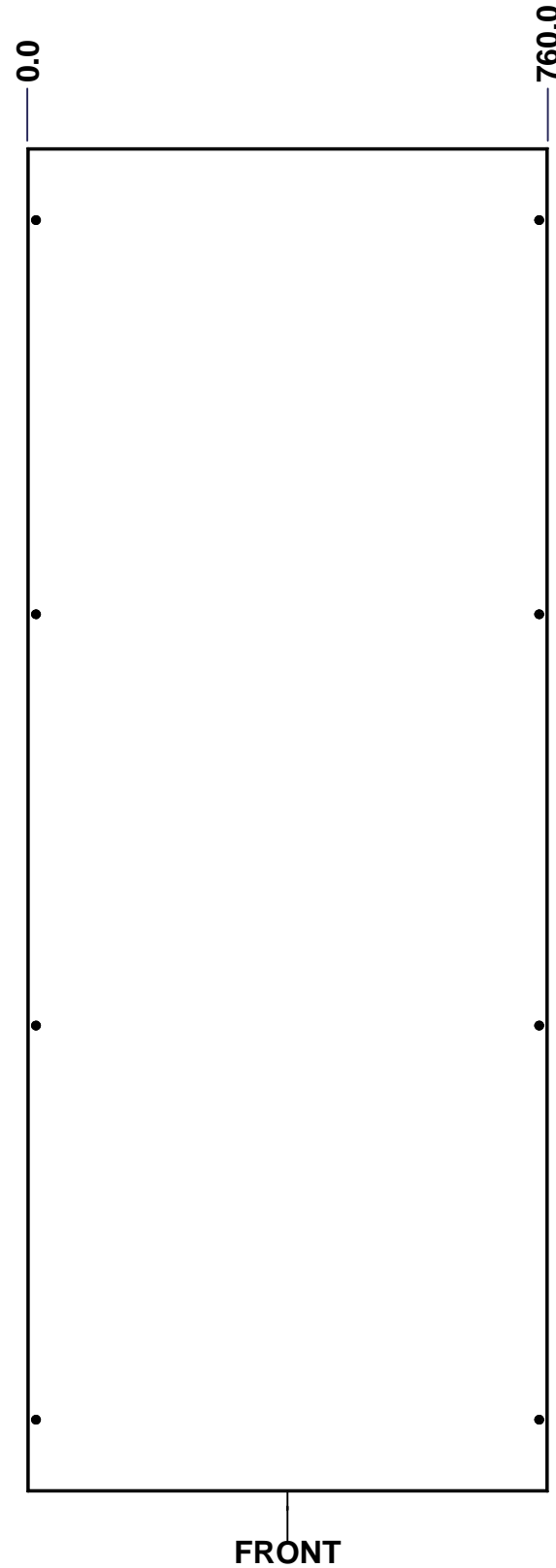
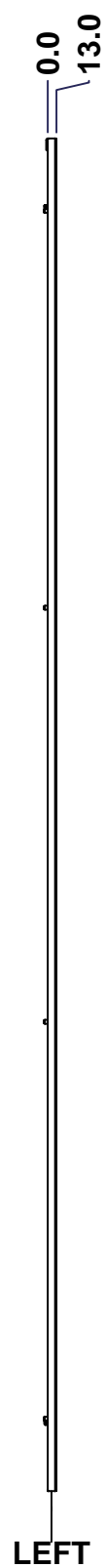
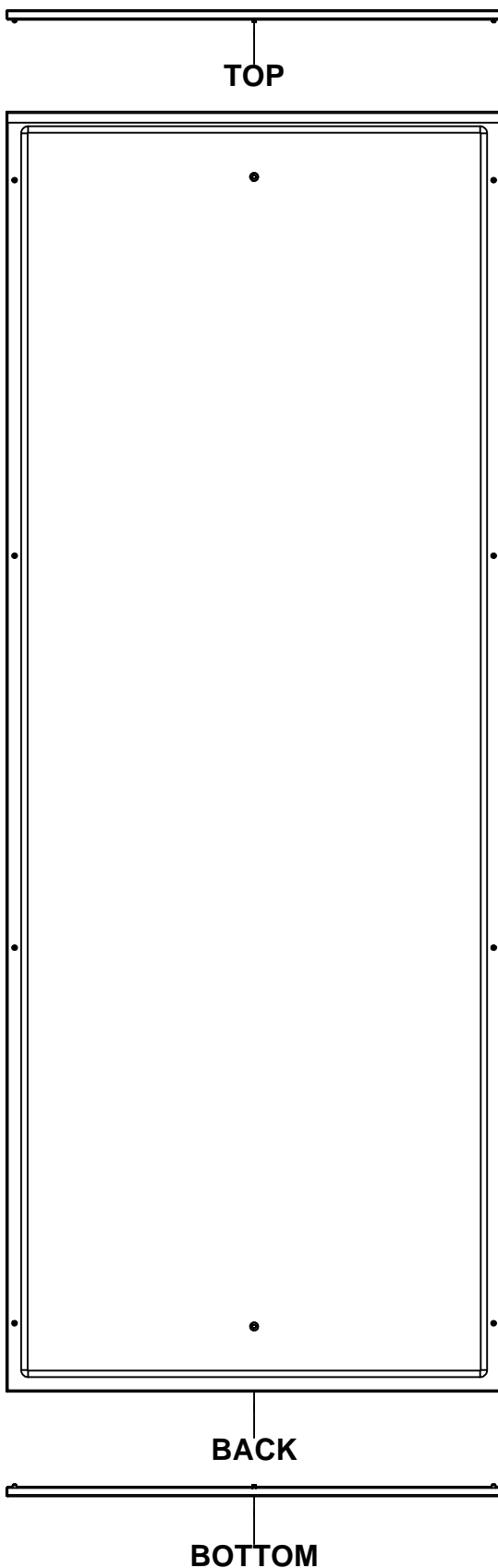

| No. | Revisions | Date       | By/Par |
|-----|-----------|------------|--------|
| 1   |           | 07/08/2014 |        |
|     |           |            |        |
|     |           |            |        |
|     |           |            |        |
|     |           |            |        |

**Isometric View**

|   |  |                                     |       |
|---|--|-------------------------------------|-------|
| <p>Tél: (450) 979-4373<br/>Fax: (450) 979-4626<br/><a href="http://www.exmweb.com">www.exmweb.com</a></p> |  | Flatness<br>Aplatissement           |       |
|   |  | Max 3.0mm                           |       |
| Customer<br>Client  |  | Projection                          |       |
| Date  |  |                                     |       |
| Drawn By<br>Dessiné Par BoxCad: Annie   |  | Date 08/04/2013                     |       |
| Material<br>Matière 16 Ga H.R.P. & O. (1.4mm)   |  | Color<br>Couleur Light Grey RAL7035 |       |
| Finish<br>Fin Rough Textured  |  | Description                         |       |
| Detail Rev.   |  | 6500 MXC 2000mm x 800mm Left        |       |
| Part Number<br>Numéro Pièce <b>6500MXK200608L</b>   |  | Rev. <b>1</b>                       | 1 / 3 |

**SEE BILL OF MATERIAL ON LAST PAGE**

This drawing is confidential and must not be reproduced or used without the consent of EXM

Ce dessin est confidentiel et ne doit pas être reproduit ou utilisé sans le consentement de EXM

| STANDARD FEATURES ARE NOT LISTED IN THIS HOLE TABLE |       |        |                             |
|---|-------|--------|-----------------------------|
| HOLE TABLE - FRONT VIEW (CUSTOM FEATURE ONLY)       |       |        |                             |
| CUT-OUT   | XDIM  | YDIM   | DESCRIPTION                 |
| 1   | 380.0 | 100.0  | GND STUD M6 x 16mm (Inside) |
| 2   | 380.0 | 1860.0 | GND STUD M6 x 16mm (Inside) |

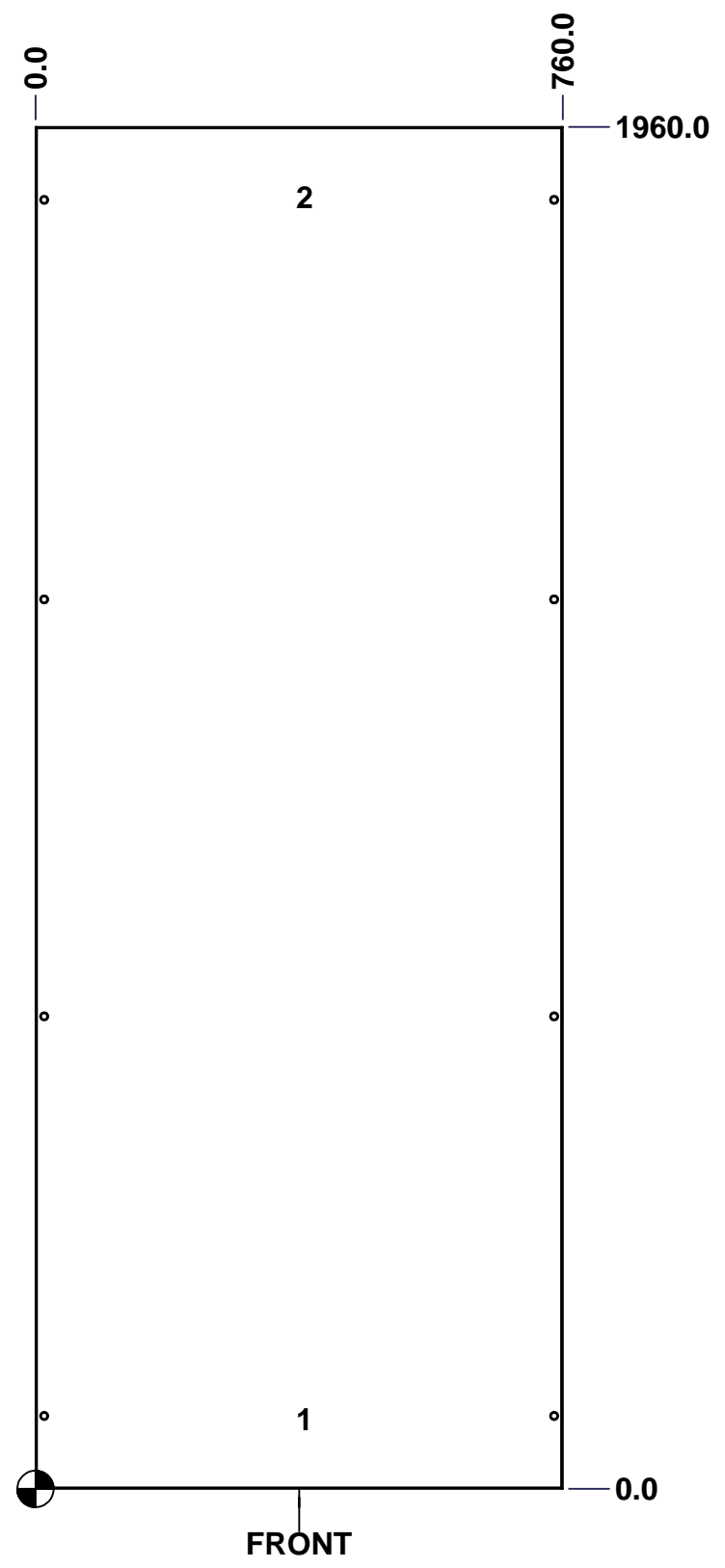



|  |                              |          |        |
|--|------------------------------|----------|--------|
|  | Description                  | Status   |        |
|  | 6500 MXC 2000mm x 800mm Left | (NULL)   |        |
|  | Part Number<br>Numéro Pièce  | Rev.     |        |
|  | <b>6500MXK200608L</b>        | <b>1</b> | 2<br>3 |

This drawing is confidential and must not be reproduced or used without the consent of EXM

Ce dessin est confidentiel et ne doit pas être reproduit ou utilisé sans le consentement de EXM

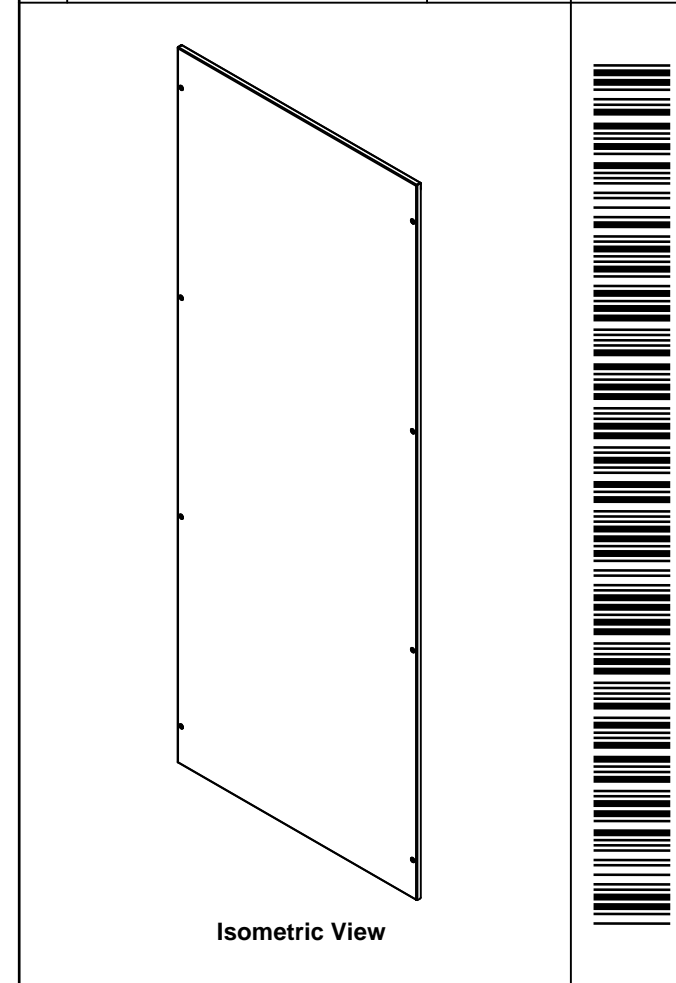
| No. | Revisions | Date       | By/Par |
|-----|-----------|------------|--------|
| 1   |           | 07/08/2014 |        |
|     |           |            |        |
|     |           |            |        |
|     |           |            |        |
|     |           |            |        |

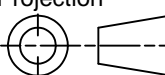

|  |                           |   |
|--|---------------------------|---|
|  Tél: (450) 979-4373<br>Fax: (450) 979-4626<br><a href="http://www.exmweb.com">www.exmweb.com</a> |                           | Flatness<br>Aplatissement<br>Max 3.0mm<br>Projection<br> |
| Customer<br>Client   | Date                      |   |
| Drawn By<br>Dessiné Par  | BoxCad: Annie             | Date 08/04/2013   |
| Material<br>Matière  | 16 Ga H.R.P. & O. (1.4mm) |   |
| Color<br>Couleur   | Light Grey RAL7035        | Finish<br>Fini<br>Rough<br>Textured   |
| Description  | Detail Rev.               |   |
| 6500 MXC 2000mm x 800mm Left   |                           |   |
| Part Number<br>Numéro Pièce  | Rev. 3                    | 3   |
| <b>6500MXK200608L</b>  |                           | <b>1</b>  |

| Qty        | Part Number      | Rev   | Description                                |
|------------|------------------|-------|--|
| 1          | STK-P-03820R     | 0     | Powder Paint (Light Grey / Rough Textured) |
| 8          | STK-Q-03072      | 2     | M6 x 17mm Phillips Flat Head Screw         |
| 2          | STK-Q-16080      | 0.1.1 | M6 x 16mm Ground Stud                      |
| 1          | 6500MXK200608LG  | 1     | 6500 MXC 2000mm x 800mm Left Gasket        |
| 1          | 6500MXK200608L-P | 1     | 6500 MXC 2000mm x 800mm Left Part          |
| Parts List |                  |       |  |

This drawing is confidential and must not be reproduced or used without the consent of EXM

Ce dessin est confidentiel et ne doit pas être reproduit ou utilisé sans le consentement de EXM

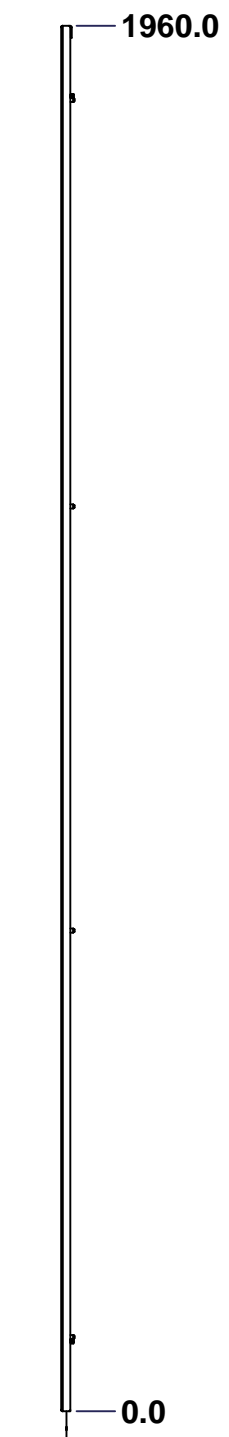
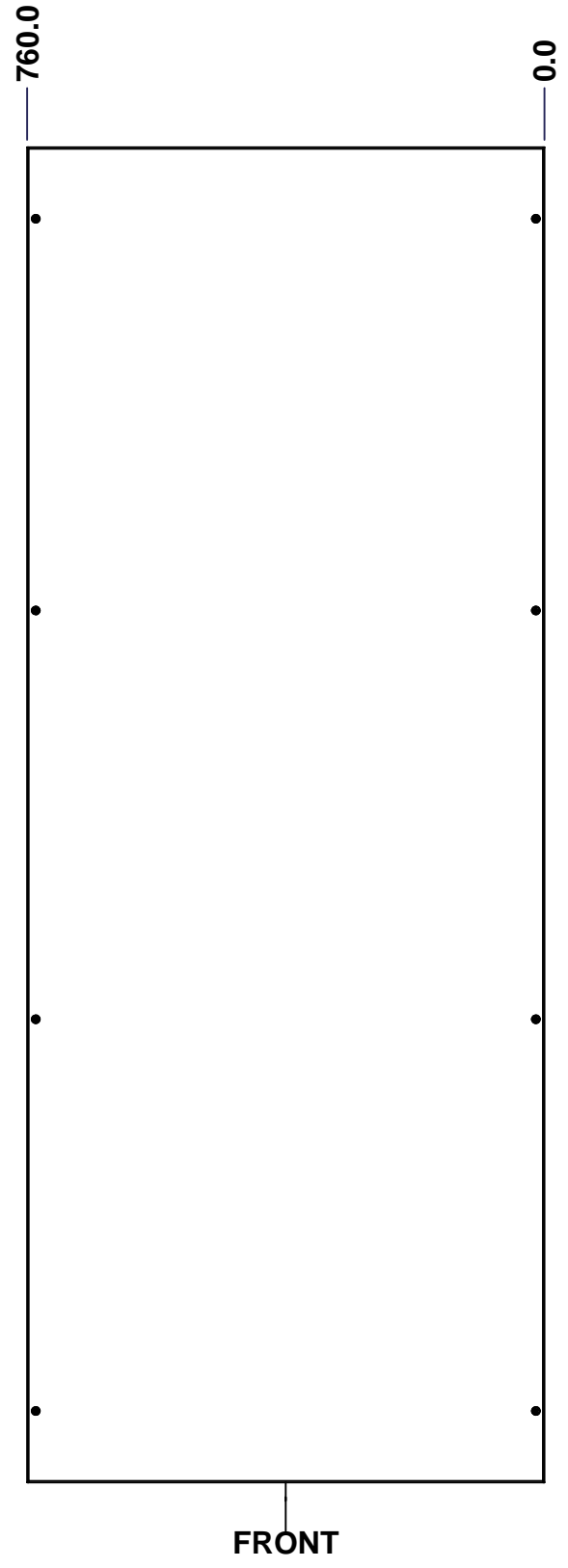
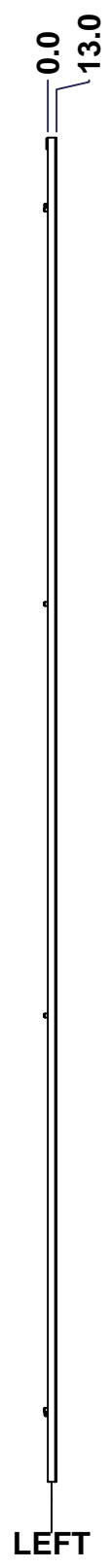
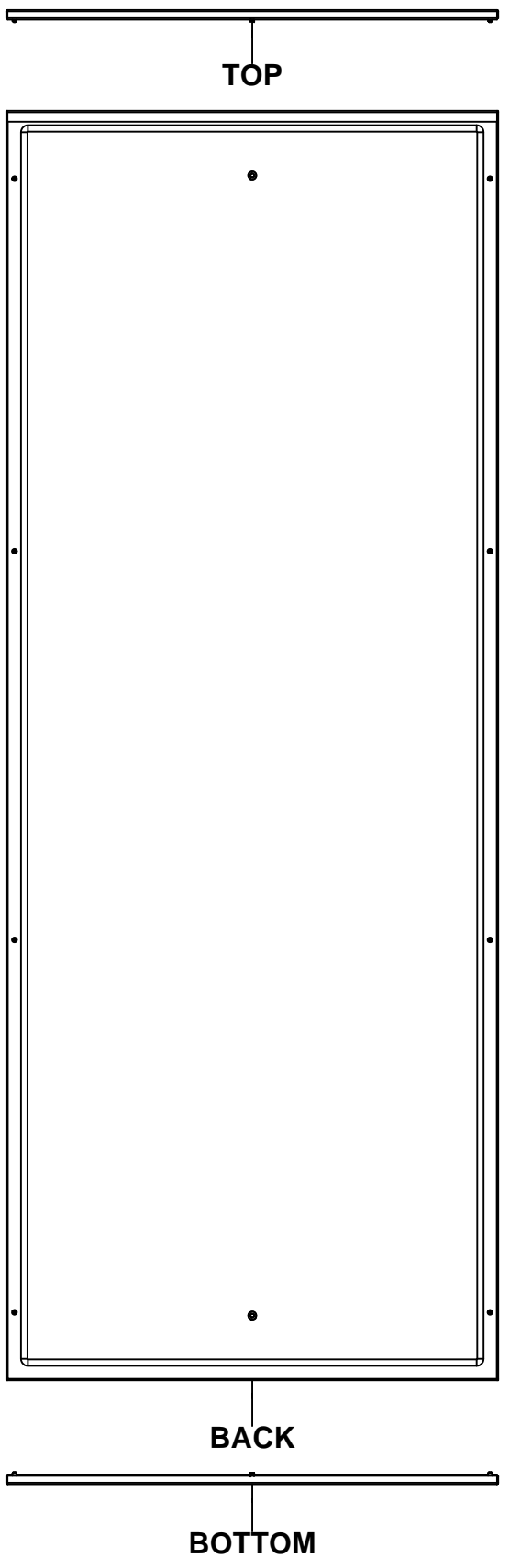

| No. | Revisions | Date       | By/Par |
|-----|-----------|------------|--------|
| 1   |           | 07/08/2014 |        |
|     |           |            |        |
|     |           |            |        |
|     |           |            |        |

**Isometric View**

|  |  |                                      |       |
|--|--|--------------------------------------|-------|
| Tél: (450) 979-4373<br>Fax: (450) 979-4626<br><a href="http://www.exmweb.com">www.exmweb.com</a> |  | Flatness<br>Aplatissement            |       |
|  |  | Max 3.0mm                            |       |
| Customer<br>Client   |  | Projection                           |       |
| Date   |  |                                      |       |
| Drawn By<br>Dessiné Par: BoxCad: Annie   |  | Date: 08/04/2013                     |       |
| Material<br>Matière: 16 Ga H.R.P. & O. (1.4mm)   |  | Color<br>Couleur: Light Grey RAL7035 |       |
| Description  |  | Finish<br>Fin: Rough Textured        |       |
| 6500 MXC 2000mm x 800mm Right  |  | Detail Rev.                          |       |
| Part Number<br>Numéro Pièce: <b>6500MXK200608R</b>   |  | Rev. <b>1</b>                        | 1 / 3 |

**SEE BILL OF MATERIAL ON LAST PAGE**

This drawing is confidential and must not be reproduced or used without the consent of EXM

Ce dessin est confidentiel et ne doit pas être reproduit ou utilisé sans le consentement de EXM

| STANDARD FEATURES ARE NOT LISTED IN THIS HOLE TABLE |       |        |                             |
|---|-------|--------|-----------------------------|
| HOLE TABLE - FRONT VIEW (CUSTOM FEATURE ONLY)       |       |        |                             |
| CUT-OUT   | XDIM  | YDIM   | DESCRIPTION                 |
| 1   | 380.0 | 100.0  | GND STUD M6 x 16mm (Inside) |
| 2   | 380.0 | 1860.0 | GND STUD M6 x 16mm (Inside) |

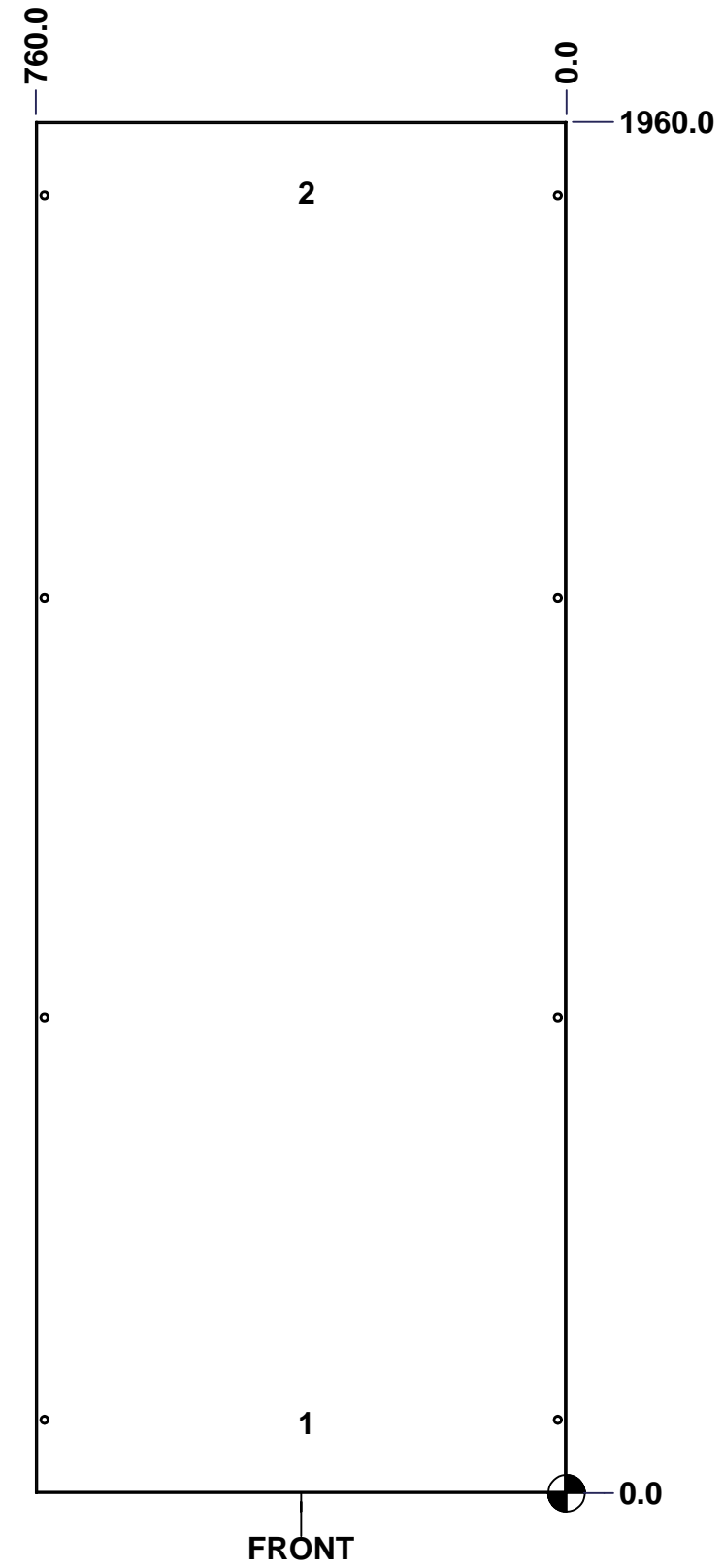



|  |                               |          |        |
|--|-------------------------------|----------|--------|
|  | Description                   | Status   |        |
|  | 6500 MXC 2000mm x 800mm Right | (NULL)   |        |
|  | Part Number<br>Numéro Pièce   | Rev.     |        |
|  | <b>6500MXK200608R</b>         | <b>1</b> | 2<br>3 |

This drawing is confidential and must not be reproduced or used without the consent of EXM

Ce dessin est confidentiel et ne doit pas être reproduit ou utilisé sans le consentement de EXM

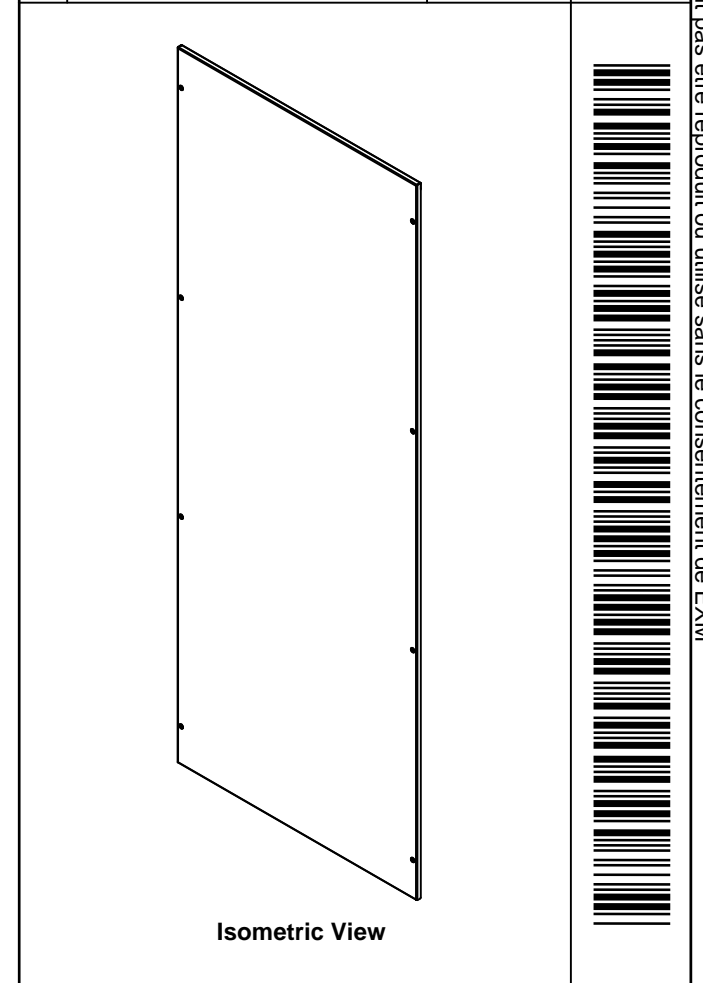
| No. | Revisions | Date       | By/Par |
|-----|-----------|------------|--------|
| 1   |           | 07/08/2014 |        |
|     |           |            |        |
|     |           |            |        |
|     |           |            |        |
|     |           |            |        |

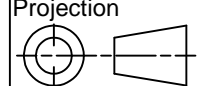

|  |                               |   |
|--|-------------------------------|---|
|  Tél: (450) 979-4373<br>Fax: (450) 979-4626<br><a href="http://www.exmweb.com">www.exmweb.com</a> |                               | Flatness<br>Aplatissement<br>Max 3.0mm<br>Projection<br> |
| Customer<br>Client   | Date                          |   |
| Drawn By<br>Dessiné Par  | BoxCad: Annie                 | Date 08/04/2013   |
| Material<br>Matière  | 16 Ga H.R.P. & O. (1.4mm)     |   |
| Color<br>Couleur   | Light Grey RAL7035            | Finish<br>Fini<br>Rough<br>Textured   |
| Description  | 6500 MXC 2000mm x 800mm Right | Detail Rev.   |
| Part Number<br>Numéro Pièce  | <b>6500MXK200608R</b>         | Rev. 3  |
|  |                               | <b>1</b>  |

| Qty        | Part Number      | Rev   | Description                                |
|------------|------------------|-------|--|
| 1          | STK-P-03820R     | 0     | Powder Paint (Light Grey / Rough Textured) |
| 8          | STK-Q-03072      | 2     | M6 x 17mm Phillips Flat Head Screw         |
| 2          | STK-Q-16080      | 0.1.1 | M6 x 16mm Ground Stud                      |
| 1          | 6500MXK200608RG  | 1     | 6500 MXC 2000mm x 800mm Right Gasket       |
| 1          | 6500MXK200608R-P | 1     | 6500 MXC 2000mm x 800mm Right Part         |
| Parts List |                  |       |  |

This drawing is confidential and must not be reproduced or used without the consent of EXM

Ce dessin est confidentiel et ne doit pas être reproduit ou utilisé sans le consentement de EXM

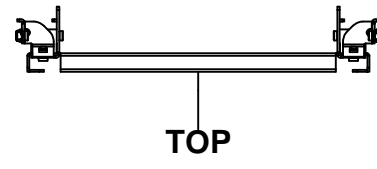

TOP

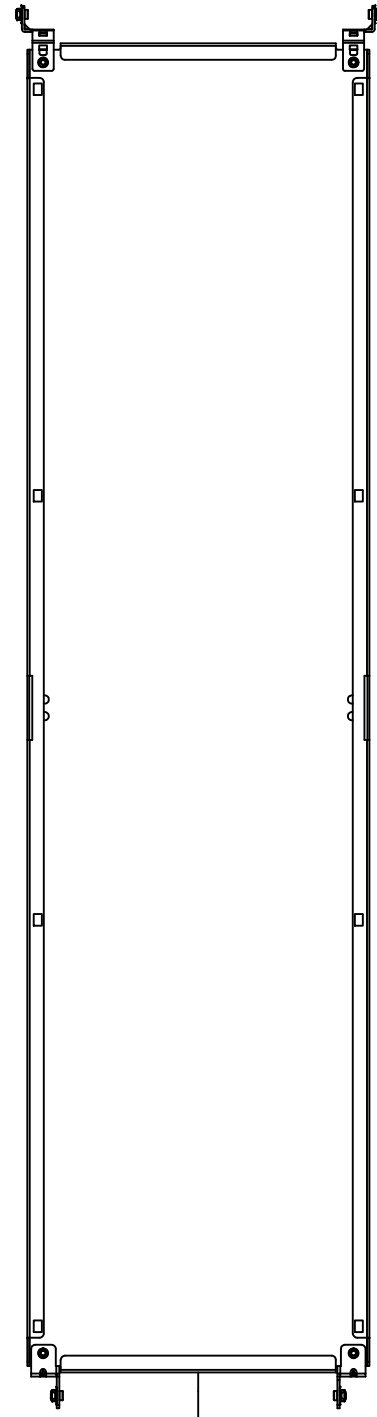

BACK



BOTTOM

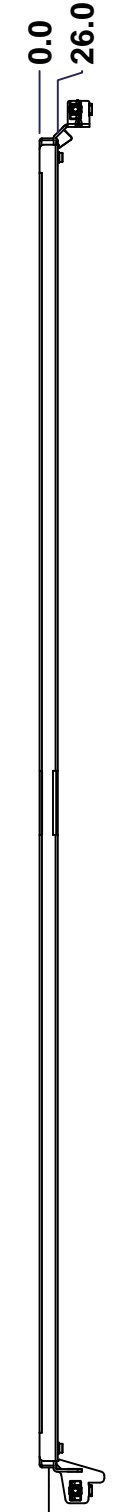

LEFT

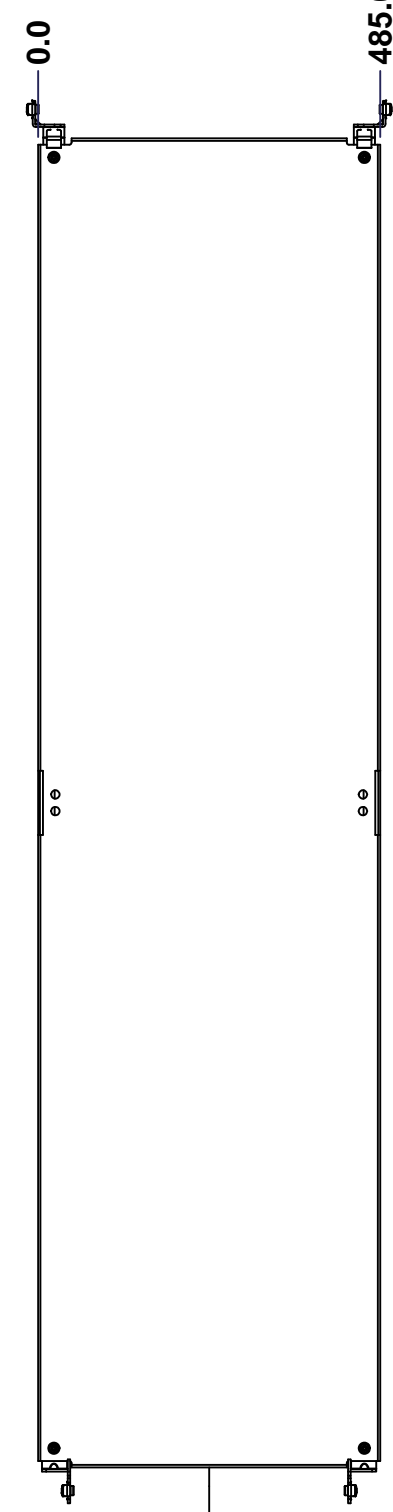

FRONT

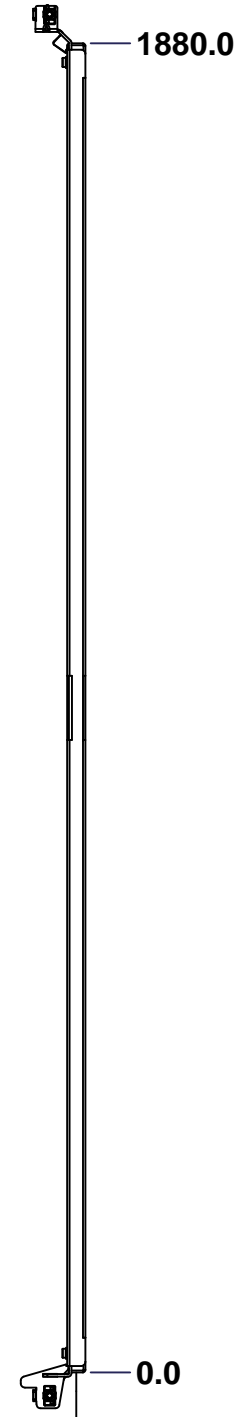

RIGHT

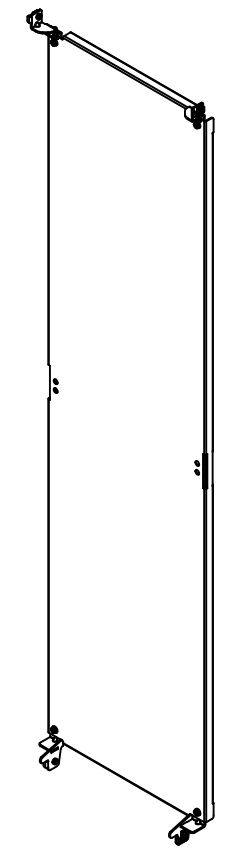

Isometric View

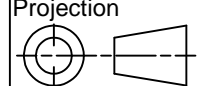

| No. | Revisions | Date       | By/Par |
|-----|-----------|------------|--------|
| 1   |           | 07/08/2014 |        |
|     |           |            |        |
|     |           |            |        |
|     |           |            |        |

|  |                          |   |
|--|--------------------------|---|
|  Tél: (450) 979-4373<br>Fax: (450) 979-4626<br><a href="http://www.exmweb.com">www.exmweb.com</a> |                          | Flatness<br>Aplatissement<br>Max 3.0mm<br>Projection<br> |
| Customer<br>Client   | Date                     |   |
| Drawn By<br>Dessiné Par  | BoxCad: Annie            | Date 08/04/2013   |
| Material<br>Matière  | 12 Ga Galvanized (2.5mm) |   |
| Color<br>Couleur   | Unpainted                | Finish<br>Fini Unpainted  |
| Description  | Detail Rev.              |   |
| 6500 MXM 2000mm x 600mm Back Inner Panel   |                          |   |
| Part Number<br>Numéro Pièce  | Rev.                     |   |
| <b>6500MXK200608BIP</b>  | <b>1</b>                 | 1 / 3   |

SEE BILL OF MATERIAL ON LAST PAGE

This drawing is confidential and must not be reproduced or used without the consent of EXM

Ce dessin est confidentiel et ne doit pas être reproduit ou utilisé sans le consentement de EXM

| No. | Revisions | Date       | By/Par |
|-----|-----------|------------|--------|
| 1   |           | 07/08/2014 |        |
|     |           |            |        |
|     |           |            |        |
|     |           |            |        |
|     |           |            |        |

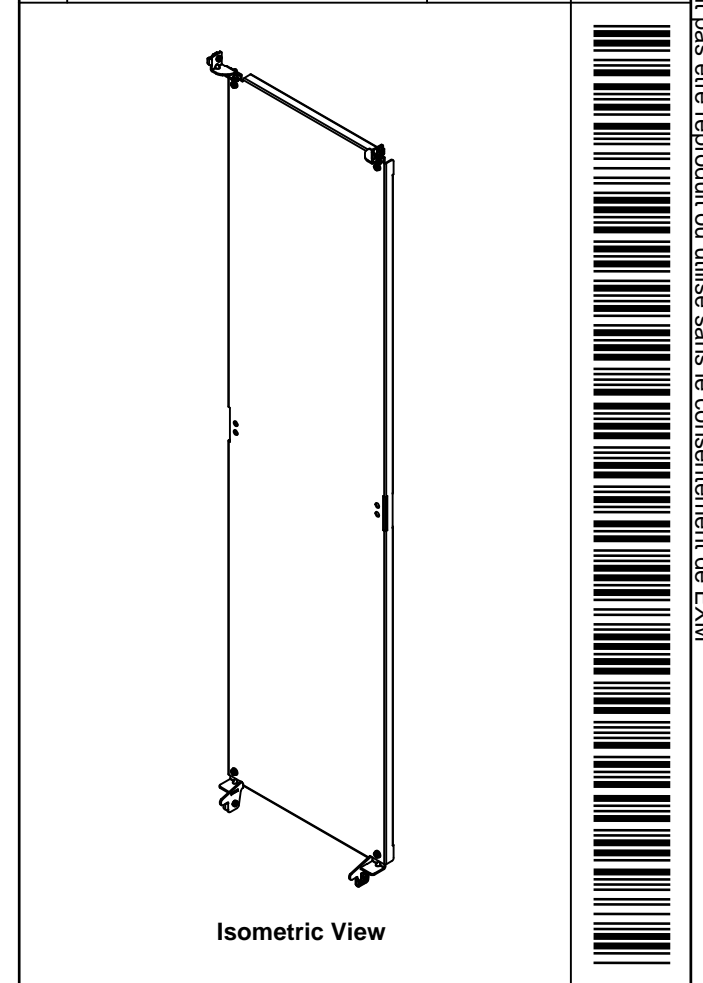

|  |                          |                           |
|--|--------------------------|---------------------------|
| Tél: (450) 979-4373<br>Fax: (450) 979-4626<br><a href="http://www.exmweb.com">www.exmweb.com</a> |                          | Flatness<br>Aplatissement |
|  |                          | Max 3.0mm                 |
| Customer<br>Client   |                          | Date                      |
| Drawn By<br>Dessiné Par BoxCad: Annie  |                          | Date 08/04/2013           |
| Material<br>Matière 12 Ga Galvanized (2.5mm)   |                          |                           |
| Color<br>Couleur Unpainted   | Finish<br>Fini Unpainted |                           |
| Description<br>6500 MXM 2000mm x 600mm Back Inner Panel  |                          | Detail Rev.               |
| Part Number<br>Numéro Pièce <b>6500MXK200608BIP</b>  |                          | Rev. 3                    |
|  |                          | <b>1</b> / 3              |

| Qty        | Part Number        | Rev | Description                                      |
|------------|--------------------|-----|--|
| 1          | STK-A-49005        | 0   | 6500MXM - Bottom Inner Panel Support Kit (Right) |
| 1          | STK-A-49000        | 0   | 6500MXM - Bottom Inner Panel Support Kit (Left)  |
| 1          | STK-A-49015        | 0   | 6500MXM - Top Inner Panel Support Kit (Right)    |
| 1          | STK-A-49010        | 0   | 6500MXM - Top Inner Panel Support Kit (Left)     |
| 1          | 6500MXK200608BIP-P | 1   | 6500 MXM 2000mm x 600mm Back Inner Panel Part    |
| Parts List |                    |     |  |