

This drawing is confidential and must not be reproduced or used without the consent of EXM

Ce dessin est confidentiel et ne doit pas être reproduit ou utilisé sans le consentement de EXM

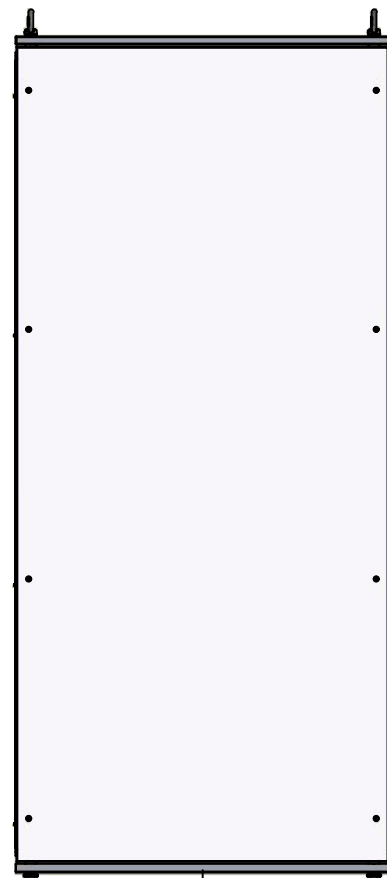

TOP



BACK

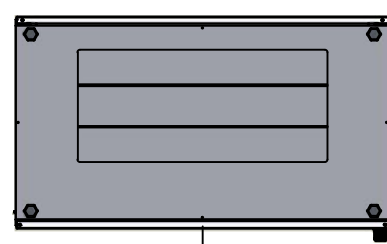

BOTTOM

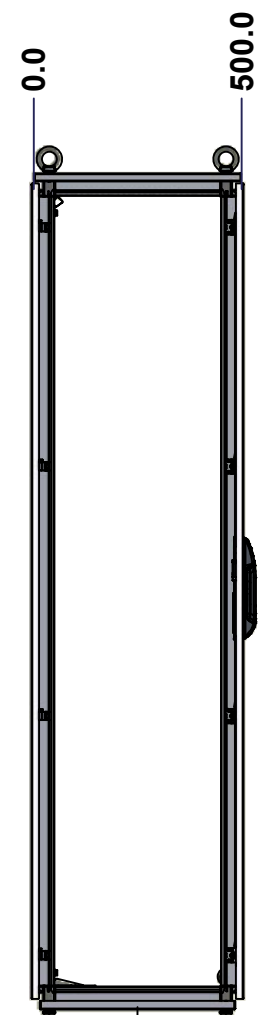

LEFT

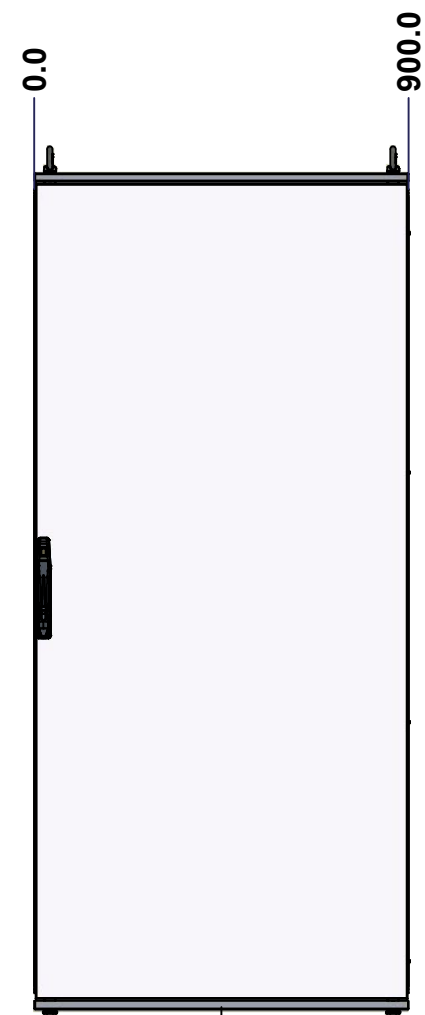

FRONT

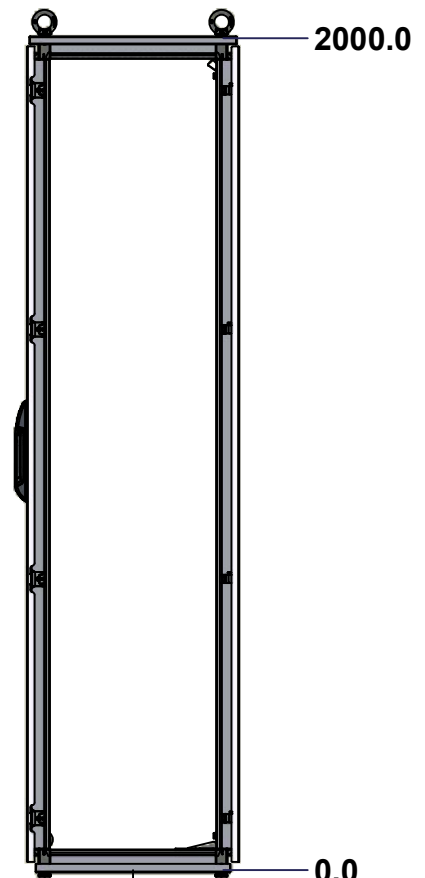

RIGHT



Isometric View



No.	Revisions	Date	By/Par



Tél: (450) 979-4373  
 Fax: (450) 979-4626  
[www.exmweb.com](http://www.exmweb.com)

Flatness  
Aplatissement  
Max 3.0mm  
Projection

Customer Client	Date
Drawn By Dessiné Par BoxCad: BoxCad	Date 8/8/2014
Material Matière	See Part List
Color Couleur	See Part List
Finish Fini	See Part List
Description 6500MX 2000mm x 900mm x 500mm Assembly	Detail Rev.

Part Number Numéro Pièce	Rev.	1
<b>6500MXK200905</b>	<b>0</b>	18

SEE BILL OF MATERIAL ON LAST PAGE

This drawing is confidential and must not be reproduced or used without the consent of EXM

Ce dessin est confidentiel et ne doit pas être reproduit ou utilisé sans le consentement de EXM

No.	Revisions	Date	By/Par



Isometric View



Tél: (450) 979-4373  
 Fax: (450) 979-4626  
[www.exmweb.com](http://www.exmweb.com)

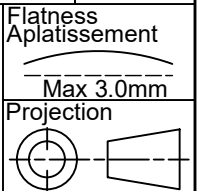

Customer Client	Date
Drawn By / Dessiné Par: BoxCad: BoxCad	Date: 8/8/2014
Material / Matière	See Part List

Color / Couleur	See Part List	Finish / Fini	See Part List
Description		Detail Rev.	
6500MX 2000mm x 900mm x 500mm Assembly			

Part Number / Numéro Pièce	Rev.	2
<b>6500MXK200905</b>	<b>0</b>	18

Qty	Part Number	Rev	Description
1	6500MXK200905BIP	0	6500 MXM 2000mm x 900mm Back Inner Panel
1	6500MXK200905F	0	6500 MXD 2000mm x 900mm Front
1	6500MXK200905B	0	6500 MXR 2000mm x 900mm Back
1	6500MXK200905BT	0	6500 MXB 900mm x 500mm Bottom
1	6500MXK200905T	0	6500 MXT 900mm x 500mm Top
1	6500MXK200905FR	0	6500 MX 2000mm x 900mm x 500mm Frame
Parts List			

This drawing is confidential and must not be reproduced or used without the consent of EXM

Ce dessin est confidentiel et ne doit pas être reproduit ou utilisé sans le consentement de EXM



TOP

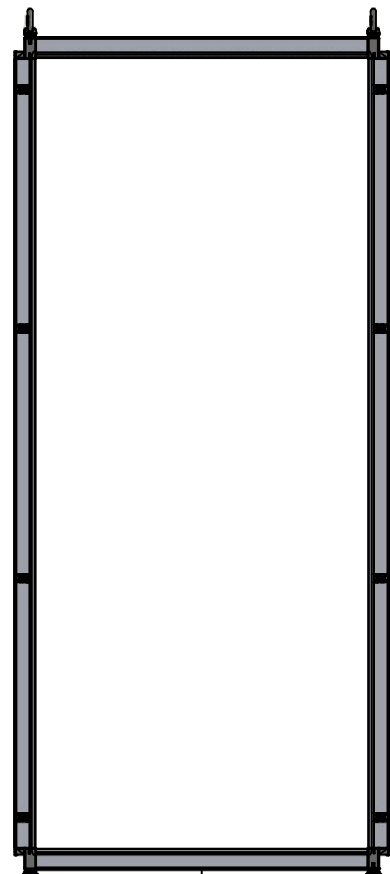

BACK



BOTTOM

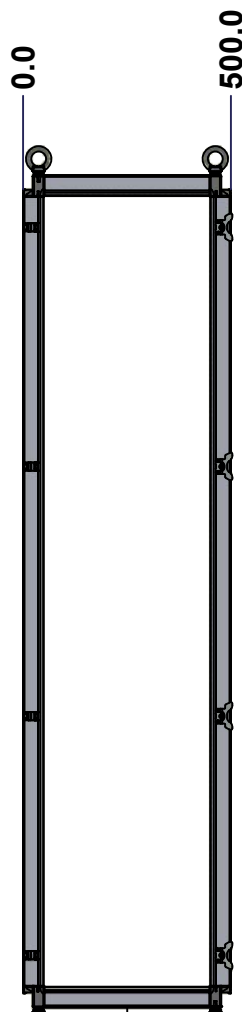

LEFT

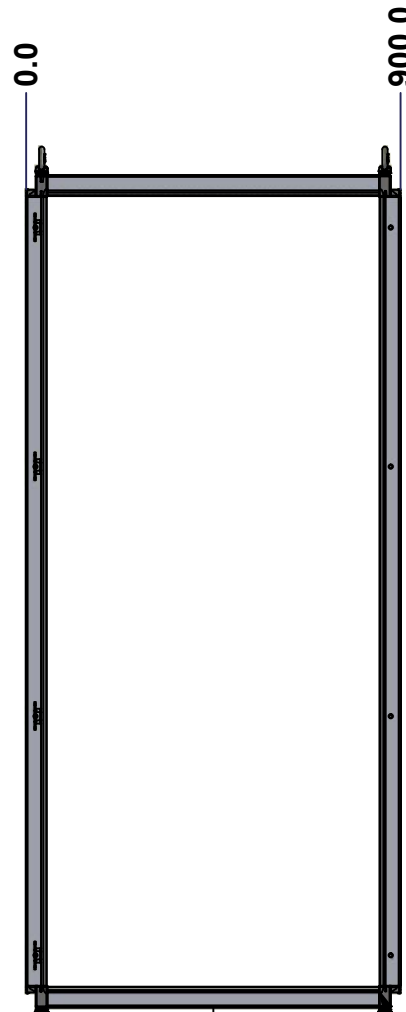

FRONT

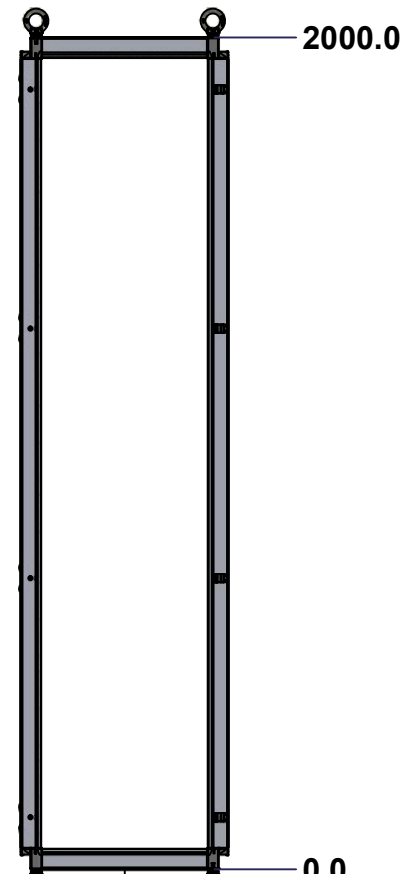

RIGHT

Grind excess weld off corner(s)

No.	Revisions	Date	By/Par

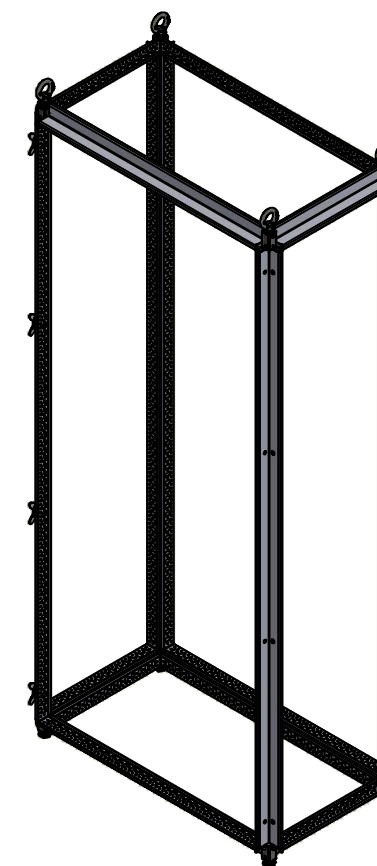

Isometric View

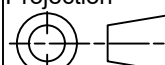

 Tél: (450) 979-4373 Fax: (450) 979-4626 <a href="http://www.exmweb.com">www.exmweb.com</a>		Flatness Aplatissement Max 3.0mm Projection 
Customer Client	Date	
Drawn By Dessiné Par	BoxCad: BoxCad	Date 8/8/2014
Material Matière	16 Ga Electro-Galvanized (1.4mm)	
Color Couleur	Iron Grey RAL7011	Finish Fini Rough Textured
Description 6500 MX 2000mm x 900mm x 500mm Frame		Detail Rev.
Part Number Numéro Pièce	6500MXK200905FR	Rev. 3 0

SEE BILL OF MATERIAL ON LAST PAGE

This drawing is confidential and must not be reproduced or used without the consent of EXM

Ce dessin est confidentiel et ne doit pas être reproduit ou utilisé sans le consentement de EXM

No.	Revisions	Date	By/Par

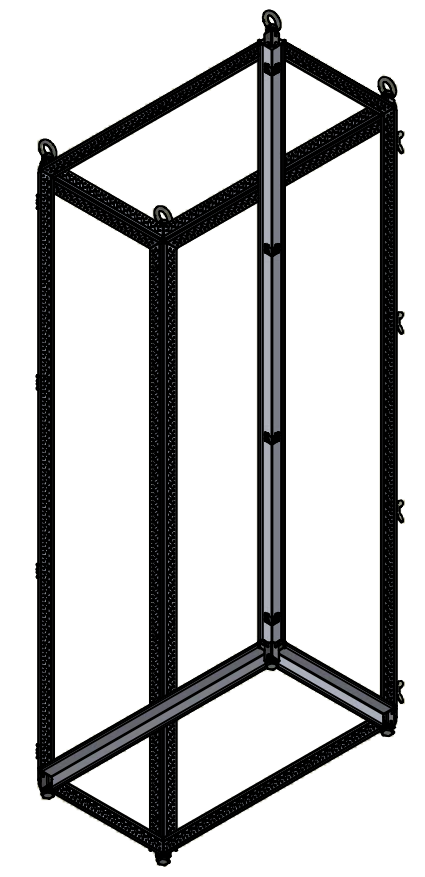

Isometric View



Tél: (450) 979-4373  
 Fax: (450) 979-4626  
[www.exmweb.com](http://www.exmweb.com)

Flatness  
Aplatissement  
Max 3.0mm  
Projection

1	STK-P-03810R	0	Powder Paint (Iron Grey / Rough Textured)
4	STK-Q-47250-09	6	6500 MX 900mm Horizontal Frame Post Part
4	STK-Q-47250-05	6	6500 MX 500mm Horizontal Frame Post Part
4	STK-A-70585	6	Fixed Bracket Assembly
16	STK-Q-77120	1	6500MX-Frame Rubber Plug
8	STK-A-70580	4	Mtrx Bracket
8	STK-Q-00610	3	M16 x 30.0mm Bolt
8	STK-A-49448	6	6500 MX - Frame Sheet Metal Corner Assembly
4	STK-Q-49500	3	M12 Eye Bolt (0.34T)
4	STK-Q-61110	0	M12 Feet Leveler
4	STK-Q-47251-20	6	6500 MX 2000mm Vertical Frame Post Part
Qty	Part Number	Rev	Description
Parts List			

Customer Client	Date
Drawn By Dessiné Par BoxCad: BoxCad	Date 8/8/2014
Material Matière	16 Ga Electro-Galvanized (1.4mm)
Color Couleur	Iron Grey RAL7011
Finish Fini	Rough Textured
Description	6500 MX 2000mm x 900mm x 500mm Frame
Part Number Numéro Pièce	<b>6500MXK200905FR</b>
Rev.	4
<b>0</b>	18

This drawing is confidential and must not be reproduced or used without the consent of EXM

Ce dessin est confidentiel et ne doit pas être reproduit ou utilisé sans le consentement de EXM



TOP



BACK

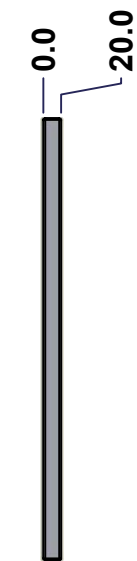

LEFT



FRONT

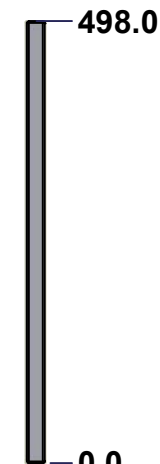



RIGHT

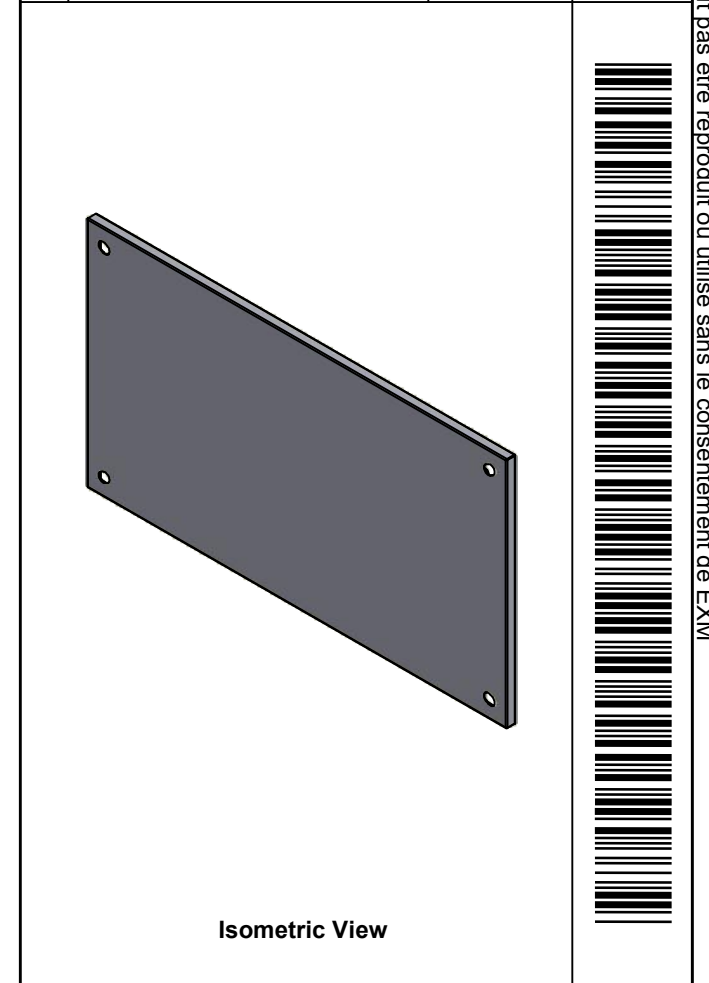

BOTTOM

No.	Revisions	Date	By/Par

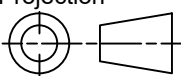

 Tél: (450) 979-4373 Fax: (450) 979-4626 <a href="http://www.exmweb.com">www.exmweb.com</a>		Flatness Aplatissement Max 3.0mm Projection 
Customer Client	Date	
Drawn By Dessiné Par	BoxCad: BoxCad	Date 8/8/2014
Material Matière	16 Ga Cold Rolled A1008 CS Type B	
Color Couleur	Iron Grey RAL7011	Finish Fini Rough Textured
Description	Detail Rev.	
6500 MXT 900mm x 500mm Top		
Part Number Numéro Pièce	Rev.	5
<b>6500MXK200905T</b>	<b>0</b>	18

Use gasket program path 6500 MX > 6500 MXT

SEE BILL OF MATERIAL ON LAST PAGE

This drawing is confidential and must not be reproduced or used without the consent of EXM

Ce dessin est confidentiel et ne doit pas être reproduit ou utilisé sans le consentement de EXM

<b>STANDARD FEATURES ARE NOT LISTED IN THIS HOLE TABLE</b>			
<b>HOLE TABLE - FRONT VIEW (CUSTOM FEATURE ONLY)</b>			
CUT-OUT	XDIM	YDIM	DESCRIPTION
1	125.0	249.0	GND STUD M6 x 18mm (Inside)
2	773.0	249.0	GND STUD M6 x 18mm (Inside)

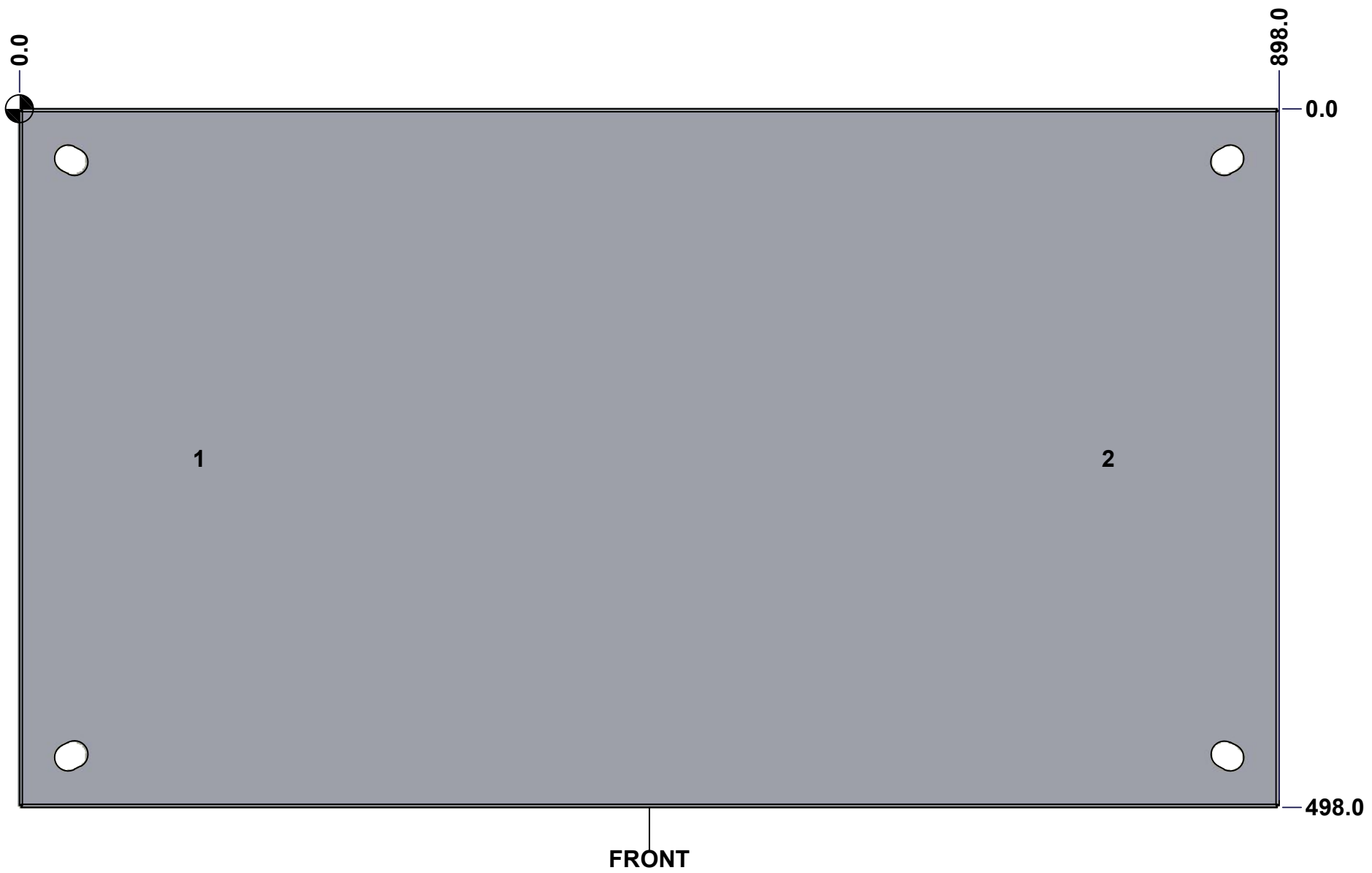

Use bending program path 6500 MX > 6500 MXT

	Description	Status
	6500 MXT 900mm x 500mm Top	(NULL)
	Part Number Numéro Pièce	Rev.
	<b>6500MXK200905T</b>	<b>0</b> / 6
		18

This drawing is confidential and must not be reproduced or used without the consent of EXM

Ce dessin est confidentiel et ne doit pas être reproduit ou utilisé sans le consentement de EXM

No.	Revisions	Date	By/Par

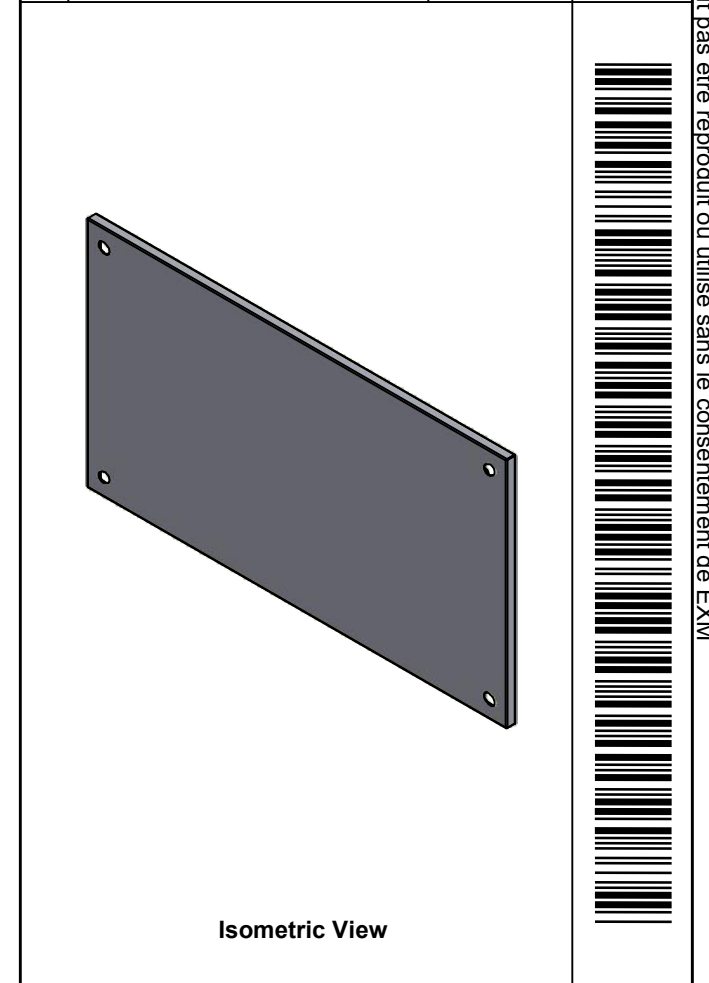

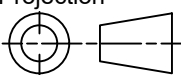
 Tél: (450) 979-4373 Fax: (450) 979-4626 <a href="http://www.exmweb.com">www.exmweb.com</a>		Flatness Aplatissement Max 3.0mm Projection 
Customer Client	Date	
Drawn By / Dessiné Par: BoxCad: BoxCad	Date: 8/8/2014	
Material / Matière: 16 Ga Cold Rolled A1008 CS Type B	Color / Couleur: Iron Grey RAL7011	
	Finish / Fini: Rough Textured	
Description: 6500 MXT 900mm x 500mm Top		Detail Rev.
Part Number / Numéro Pièce: <b>6500MXK200905T</b>		Rev. 7
		0

Qty	Part Number	Rev	Description
1	STK-P-03810R	0	Powder Paint (Iron Grey / Rough Textured)
2	STK-Q-16080	0	Ground Stud M6 x 16mm
1	6500MXK200905TG	0	6500 MXT 900mm x 500mm Top Gasket
1	6500MXK200905T-P	0	6500 MXT 900mm x 500mm Top Part
Parts List			

This drawing is confidential and must not be reproduced or used without the consent of EXM

Ce dessin est confidentiel et ne doit pas être reproduit ou utilisé sans le consentement de EXM

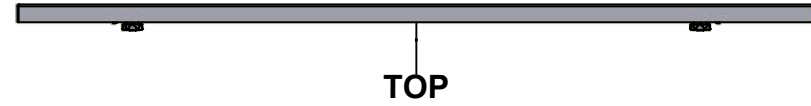

TOP



BACK

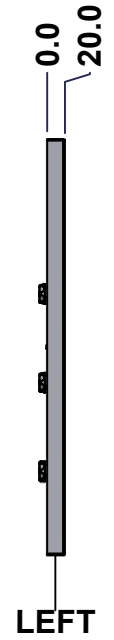

LEFT

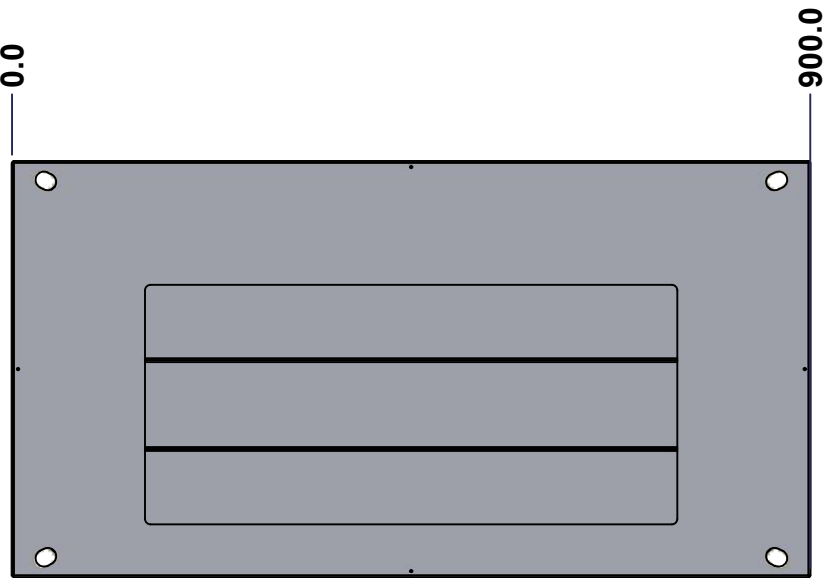

FRONT

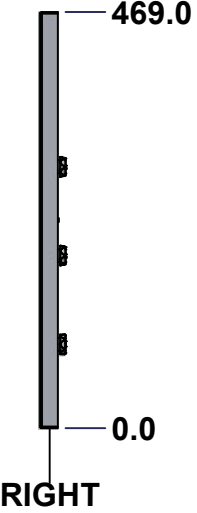



RIGHT

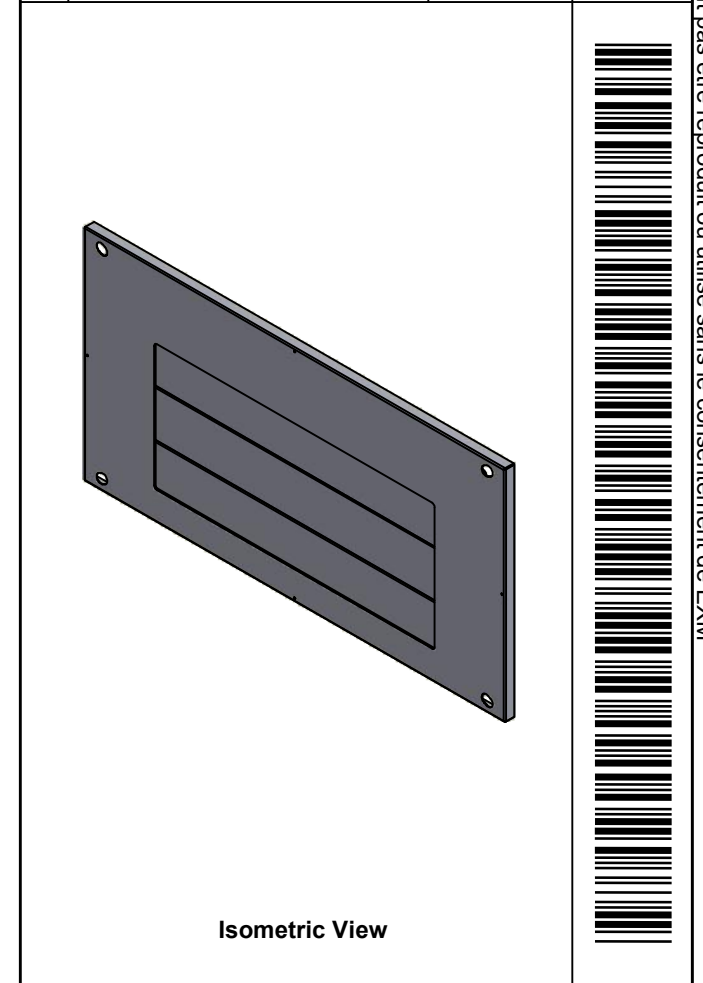

BOTTOM

No.	Revisions	Date	By/Par

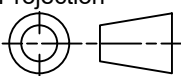

 Tél: (450) 979-4373 Fax: (450) 979-4626 <a href="http://www.exmweb.com">www.exmweb.com</a>		Flatness Aplatissement Max 3.0mm Projection 
Customer Client	Date	
Drawn By Dessiné Par	BoxCad: BoxCad	Date 8/8/2014
Material Matière	16 Ga Cold Rolled A1008 CS Type B	
Color Couleur	Iron Grey RAL7011	Finish Fini Rough Textured
Description	Detail Rev.	
6500 MXB 900mm x 500mm Bottom		
Part Number Numéro Pièce	Rev.	8
<b>6500MXK200905BT</b>	<b>0</b>	18

Use gasket program path 6500 MX > 6500MXB

SEE BILL OF MATERIAL ON LAST PAGE



This drawing is confidential and must not be reproduced or used without the consent of EXM

Ce dessin est confidentiel et ne doit pas être reproduit ou utilisé sans le consentement de EXM

**STANDARD FEATURES ARE NOT LISTED IN THIS HOLE TABLE**

**HOLE TABLE - FRONT VIEW (CUSTOM FEATURE ONLY)**

CUT-OUT	XDIM	YDIM	DESCRIPTION
1	110.0	234.5	GND STUD M6 x 18mm (Inside)
2	790.0	234.5	GND STUD M6 x 18mm (Inside)
3	130.0	294.5	GP STUD M6 x 18mm (Inside)
4	770.0	294.5	GP STUD M6 x 18mm (Inside)
5	130.0	194.5	GP STUD M6 x 18mm (Inside)
6	770.0	194.5	GP STUD M6 x 18mm (Inside)
7	130.0	94.5	GP STUD M6 x 18mm (Inside)
8	770.0	94.5	GP STUD M6 x 18mm (Inside)

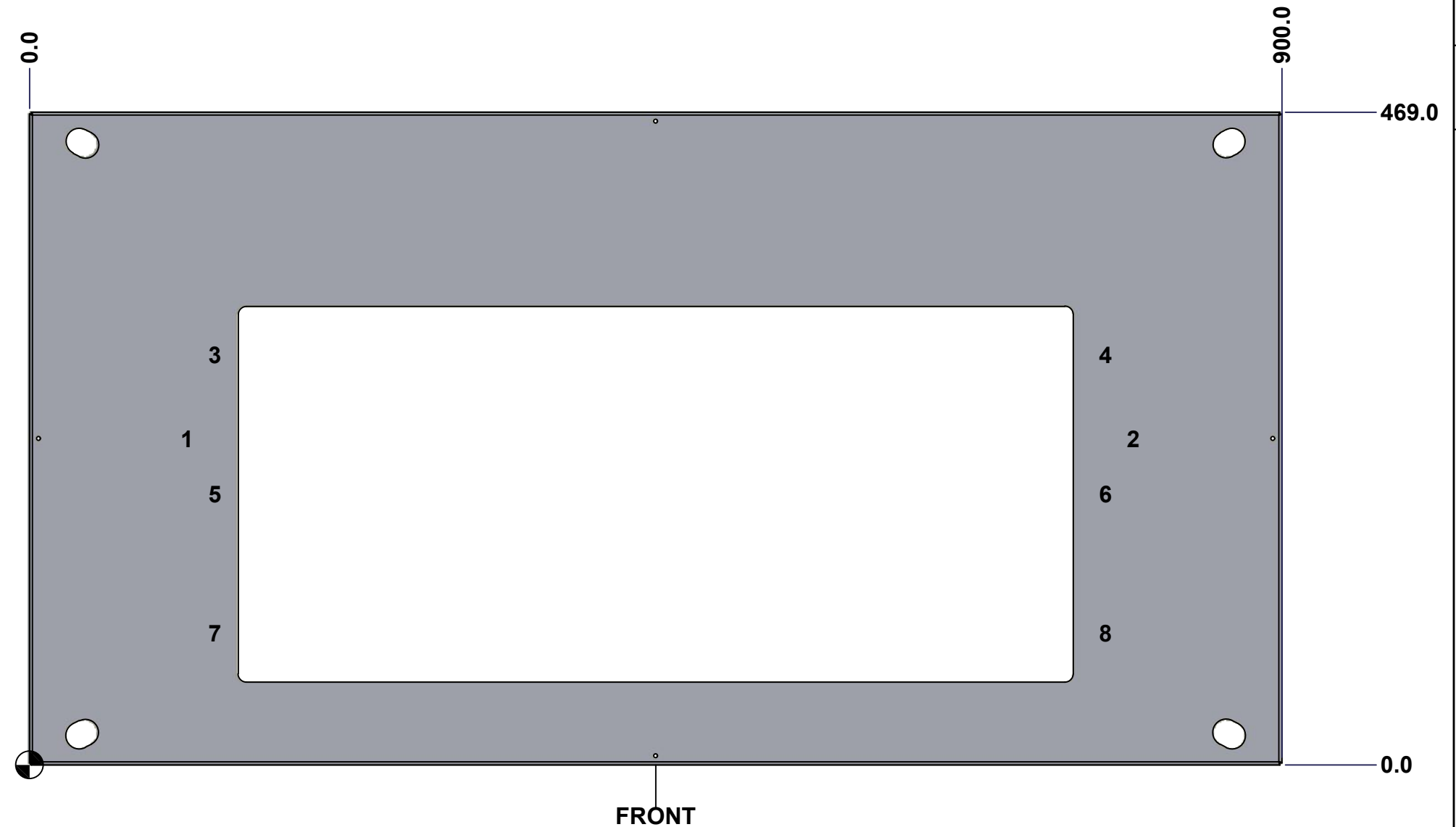

Use bending program path 6500 MX > 6500MXB

	Description	Status
	6500 MXB 900mm x 500mm Bottom	(NULL)
Part Number Numéro Pièce <b>6500MXK200905BT</b>	Rev.	9
	<b>0</b>	18

This drawing is confidential and must not be reproduced or used without the consent of EXM

Ce dessin est confidentiel et ne doit pas être reproduit ou utilisé sans le consentement de EXM

No.	Revisions	Date	By/Par

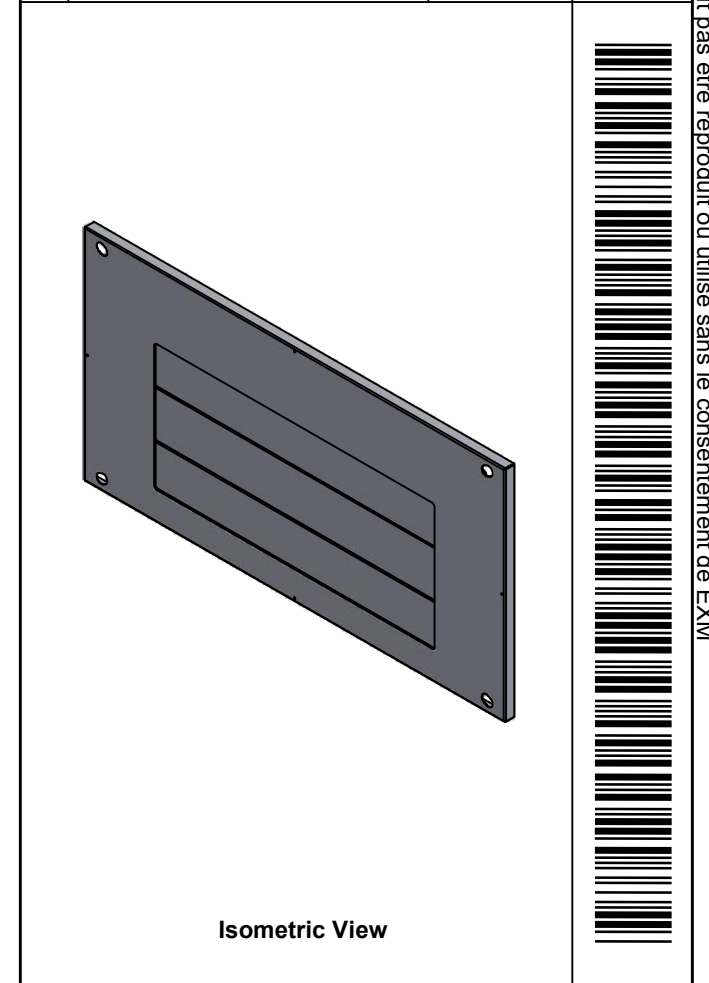

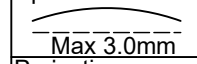
 Tél: (450) 979-4373 Fax: (450) 979-4626 <a href="http://www.exmweb.com">www.exmweb.com</a>		Flatness Aplatissement  Max 3.0mm
Customer Client		Date
Drawn By / Dessiné Par: BoxCad: BoxCad		Date: 8/8/2014
Material / Matière: 16 Ga Cold Rolled A1008 CS Type B		
Color / Couleur: Iron Grey RAL7011	Finish / Fini: Rough Textured	
Description: 6500 MXB 900mm x 500mm Bottom		Detail Rev.
Part Number / Numéro Pièce: <b>6500MXK200905BT</b>		Rev. 0

Qty	Part Number	Rev	Description
1	STK-P-03810R	0	Powder Paint (Iron Grey / Rough Textured)
6	STK-Q-06001	0	Mtrx - Gland Plate M6 Plastic Thumb Nut
8	STK-Q-16055	1	M6 x 18mm Stud (No Paint Cap Required)
3	6500MXK200905GP100-P	0	6500 MXB 900mm Gland Plate Part (100mm)
1	6500MXK200905BTGPG	0	6500 MXB 900mm x 500mm Bottom Gland Plate Gasket
1	6500MXK200905BTG	0	6500 MXB 900mm x 500mm Bottom Gasket
1	6500MXK200905BT-P	0	6500 MXB 900mm x 500mm Bottom Part
Parts List			

This drawing is confidential and must not be reproduced or used without the consent of EXM

Ce dessin est confidentiel et ne doit pas être reproduit ou utilisé sans le consentement de EXM

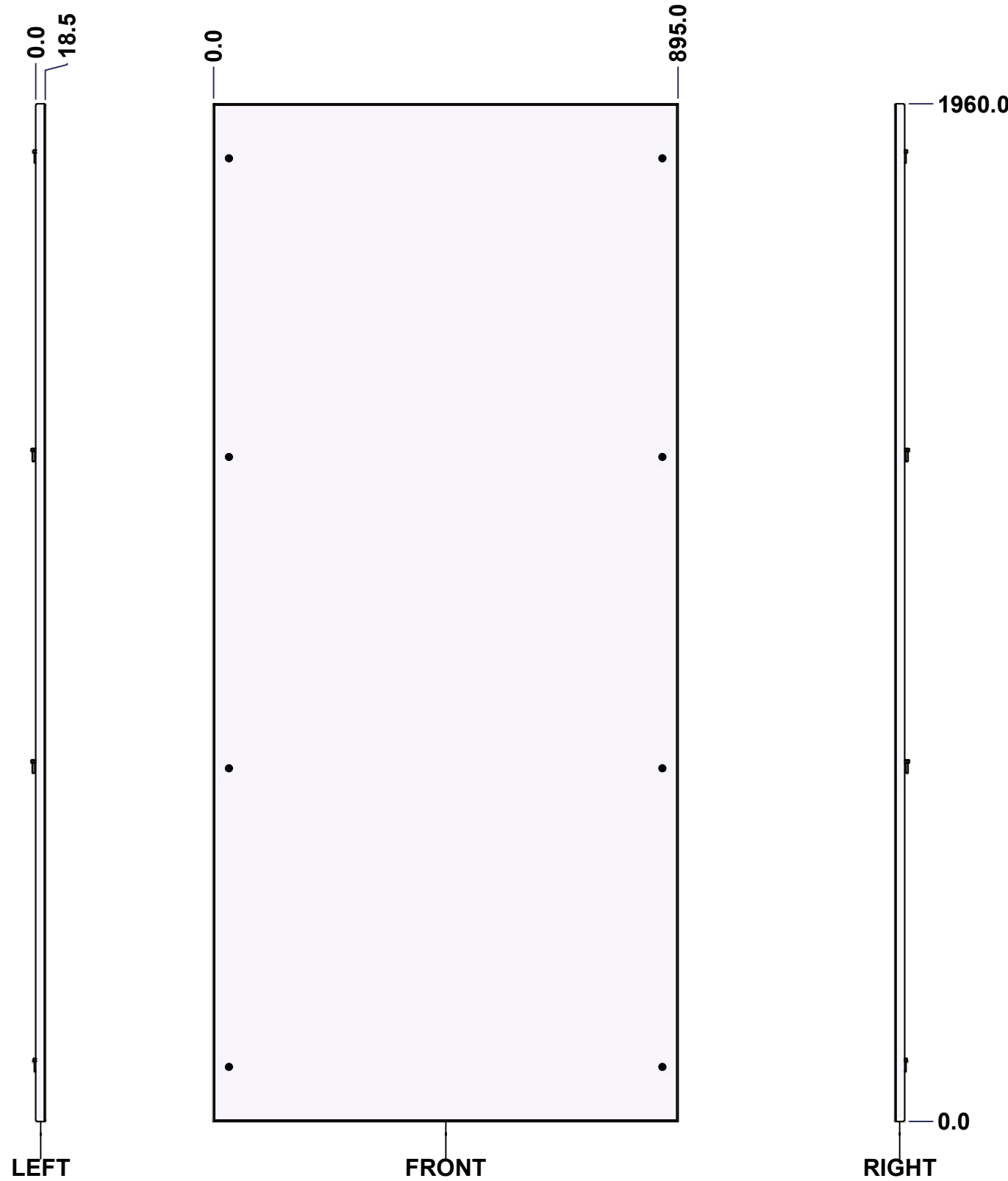
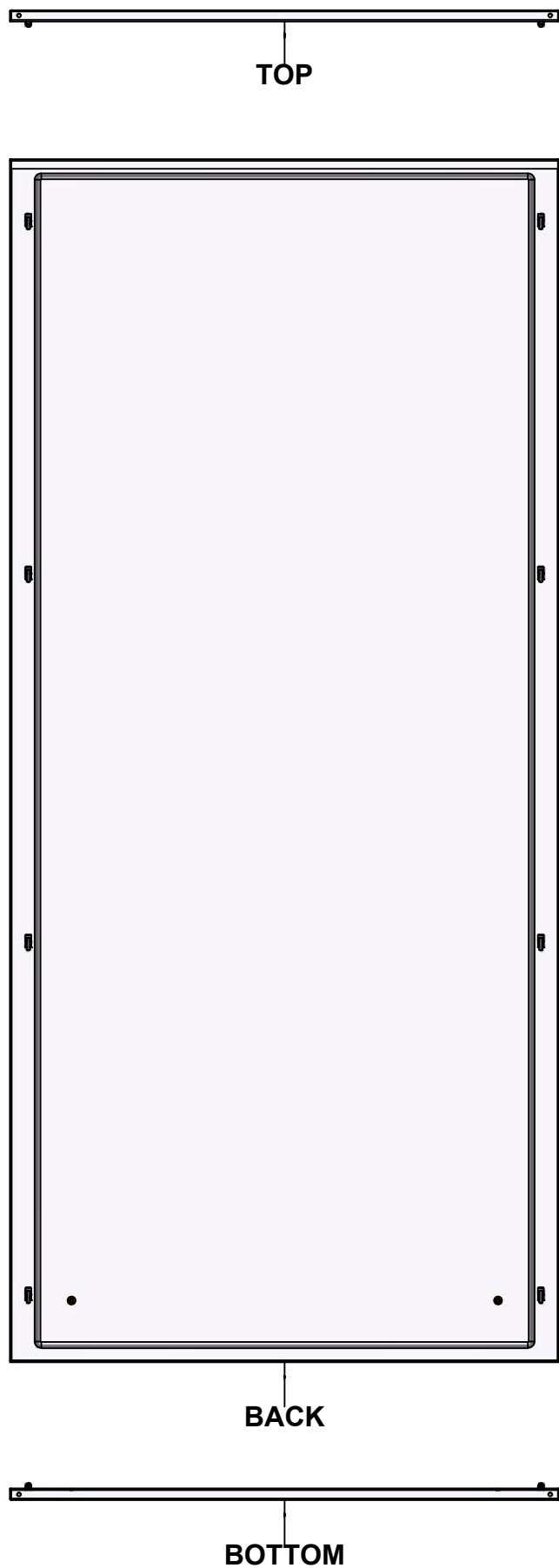

No.	Revisions	Date	By/Par

Isometric View

<p>Tél: (450) 979-4373 Fax: (450) 979-4626 <a href="http://www.exmweb.com">www.exmweb.com</a></p>		Flatness Aplatissement
		Max 3.0mm
		Projection
Customer Client		Date
Drawn By Dessiné Par	BoxCad: BoxCad	Date 8/8/2014
Material Matière	14 Ga Cold Rolled A1008 CS Type B	
Color Couleur	Light Grey RAL7035	Finish Fin Rough Textured
Description		Detail Rev.
6500 MXR 2000mm x 900mm Back		
Part Number Numéro Pièce	Rev.	11
<b>6500MXK200905B</b>	<b>0</b>	18

Use gasket program path 6500 MX > 6500 MXR

SEE BILL OF MATERIAL ON LAST PAGE

This drawing is confidential and must not be reproduced or used without the consent of EXM

Ce dessin est confidentiel et ne doit pas être reproduit ou utilisé sans le consentement de EXM

STANDARD FEATURES ARE NOT LISTED IN THIS HOLE TABLE			
HOLE TABLE - FRONT VIEW (CUSTOM FEATURE ONLY)			
CUT-OUT	XDIM	YDIM	DESCRIPTION
1	100.0	100.0	GND STUD M6 x 16mm (Inside)
2	795.0	100.0	GND STUD M6 x 16mm (Inside)

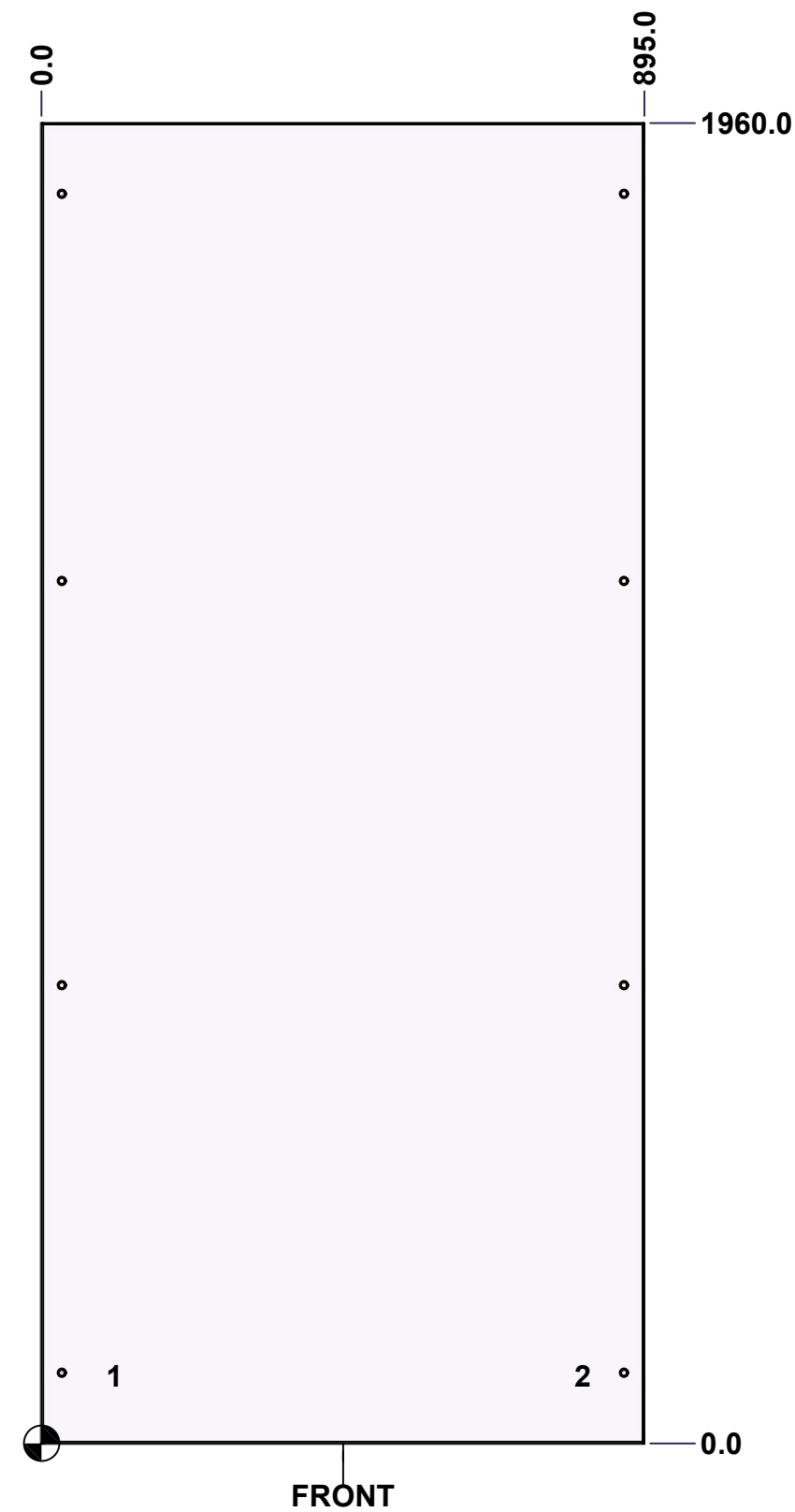

Use bending program path 6500 MX > 6500 MXR

	Description		Status	
	6500 MXR 2000mm x 900mm Back		(NULL)	
Part Number Numéro Pièce		Rev.	12	
<b>6500MXK200905B</b>		<b>0</b>	18	

This drawing is confidential and must not be reproduced or used without the consent of EXM

Ce dessin est confidentiel et ne doit pas être reproduit ou utilisé sans le consentement de EXM

No.	Revisions	Date	By/Par

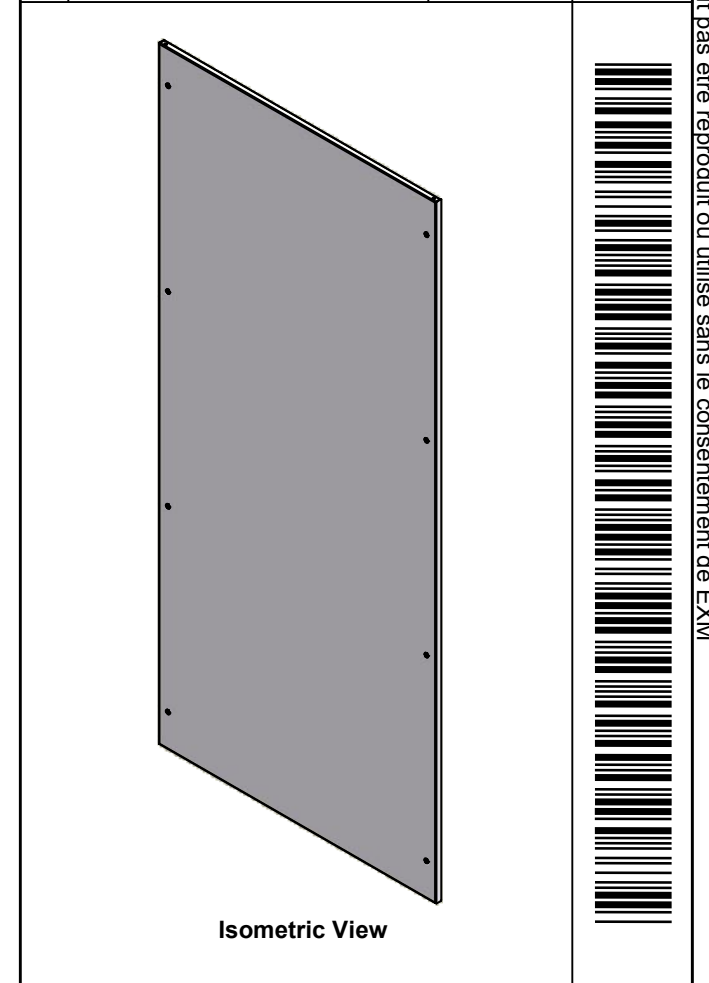

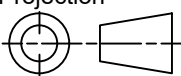
 Tél: (450) 979-4373 Fax: (450) 979-4626 <a href="http://www.exmweb.com">www.exmweb.com</a>		Flatness Aplatissement Max 3.0mm Projection 
Customer Client	Date	
Drawn By Dessiné Par	BoxCad: BoxCad	Date 8/8/2014
Material Matière	14 Ga Cold Rolled A1008 CS Type B	
Color Couleur	Light Grey RAL7035	Finish Fini Rough Textured
Description		Detail Rev.
6500 MXR 2000mm x 900mm Back		
Part Number Numéro Pièce	Rev.	13
<b>6500MXK200905B</b>	<b>0</b>	18

Qty	Part Number	Rev	Description
1	STK-P-03820R	0	Powder Paint (Light Grey / Rough Textured)
1	6500MXK200905BG	0	6500 MXR 2000mm x 900mm Back Gasket
8	STK-A-70579	3	6500 MX Side Panel Insert Assembly
8	STK-Q-03071	0	M6 x 16mm Machine Screw
2	STK-Q-16080	0	Ground Stud M6 x 16mm
1	6500MXK200905B-P	0	6500 MXR 2000mm x 900mm Back Part
Parts List			

This drawing is confidential and must not be reproduced or used without the consent of EXM

Ce dessin est confidentiel et ne doit pas être reproduit ou utilisé sans le consentement de EXM

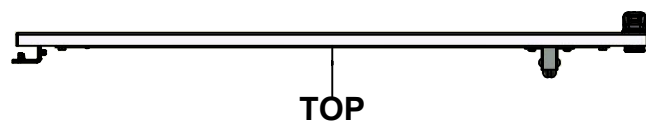

TOP

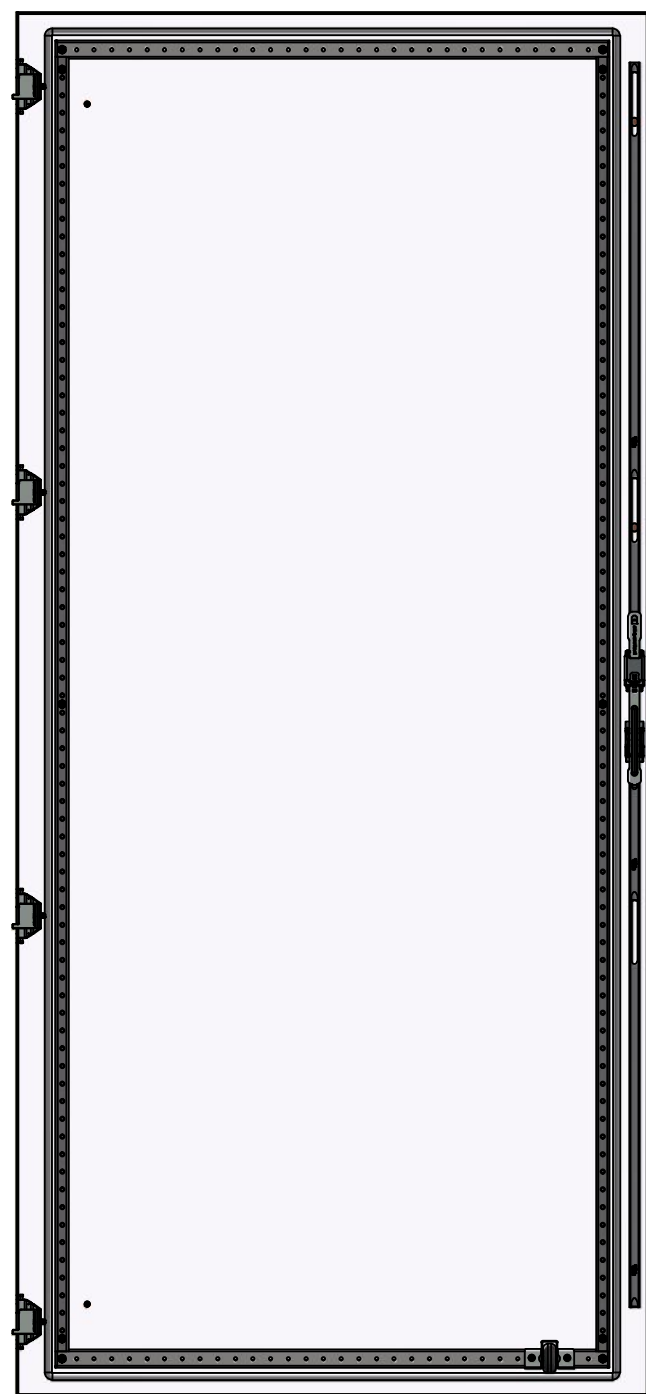

BACK



BOTTOM

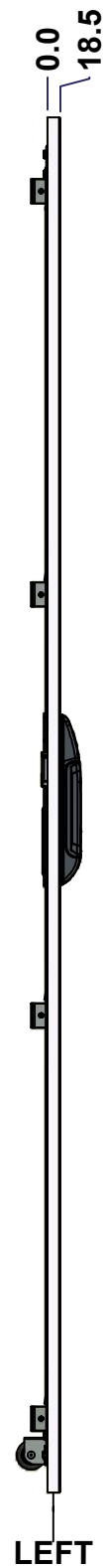

LEFT

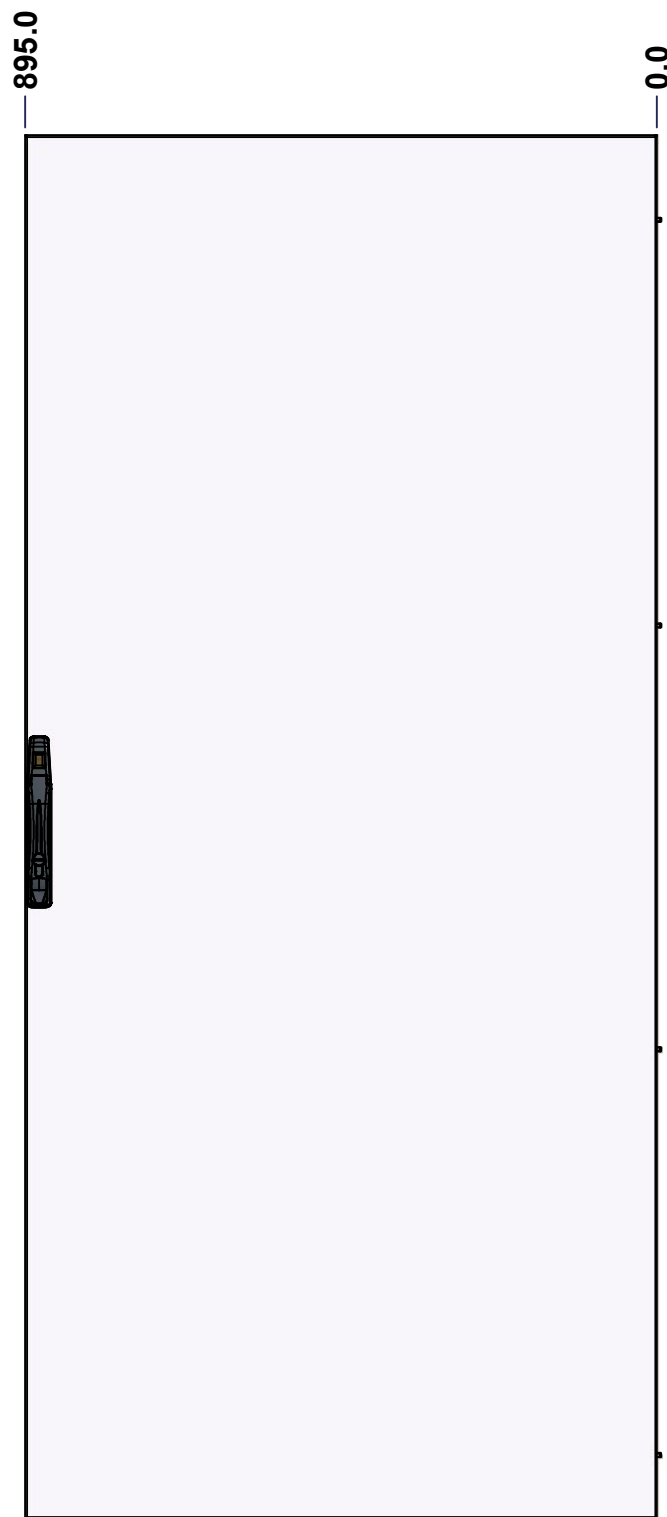

FRONT

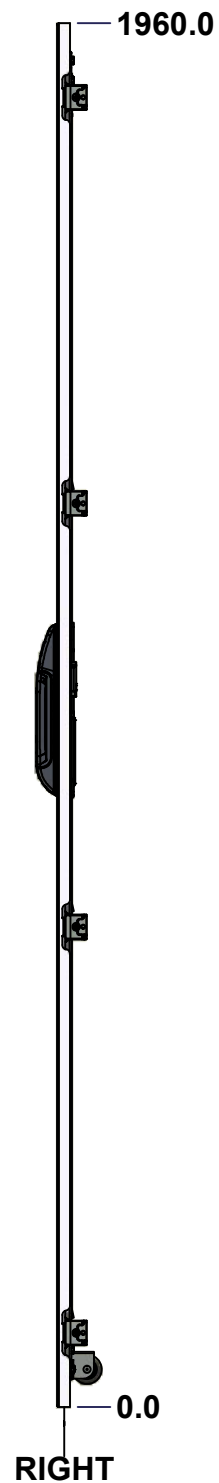

RIGHT

No.	Revisions	Date	By/Par

Isometric View

<p>Tél: (450) 979-4373 Fax: (450) 979-4626 <a href="http://www.exmweb.com">www.exmweb.com</a></p>		Flatness Aplatissement
		Max 3.0mm
		Projection
Customer Client		Date
Drawn By Dessiné Par	BoxCad: BoxCad	Date 8/8/2014
Material Matière	14 Ga Cold Rolled A1008 CS Type B	
Color Couleur	Light Grey RAL7035	Finish Fini
		Rough Textured
Description		Detail Rev.
6500 MXD 2000mm x 900mm Front		
Part Number Numéro Pièce	Rev.	14
<b>6500MXK200905F</b>	<b>0</b>	18

Use gasket program path 6500 MX > 6500 MXD

SEE BILL OF MATERIAL ON LAST PAGE

This drawing is confidential and must not be reproduced or used without the consent of EXM

Ce dessin est confidentiel et ne doit pas être reproduit ou utilisé sans le consentement de EXM

**STANDARD FEATURES ARE NOT LISTED IN THIS HOLE TABLE**

**HOLE TABLE - FRONT VIEW (CUSTOM FEATURE ONLY)**

CUT-OUT	XDIM	YDIM	DESCRIPTION
1	100.0	130.0	GND STUD M6 x 16mm (Inside)
2	100.0	1830.0	GND STUD M6 x 16mm (Inside)
3	64.5	52.8	STIFF. STUD M6 x 18mm (Inside)
4	64.5	1907.2	STIFF. STUD M6 x 18mm (Inside)
5	830.5	52.8	STIFF. STUD M6 x 18mm (Inside)
6	830.5	1907.2	STIFF. STUD M6 x 18mm (Inside)
7	64.5	980.0	STIFF. STUD M6 x 18mm (Inside)
8	830.5	980.0	STIFF. STUD M6 x 18mm (Inside)
9	830.5	1879.0	STIFF. STUD M6 x 18mm (Inside)
10	830.5	81.0	STIFF. STUD M6 x 18mm (Inside)
11	64.5	1879.0	STIFF. STUD M6 x 18mm (Inside)
12	64.5	81.0	STIFF. STUD M6 x 18mm (Inside)
13	875.5	155.0	CLOSING BAR GUIDE (Inside)
14	875.5	1805.0	CLOSING BAR GUIDE (Inside)
15	875.5	730.0	CLOSING BAR GUIDE (Inside)
16	875.5	1230.0	CLOSING BAR GUIDE (Inside)

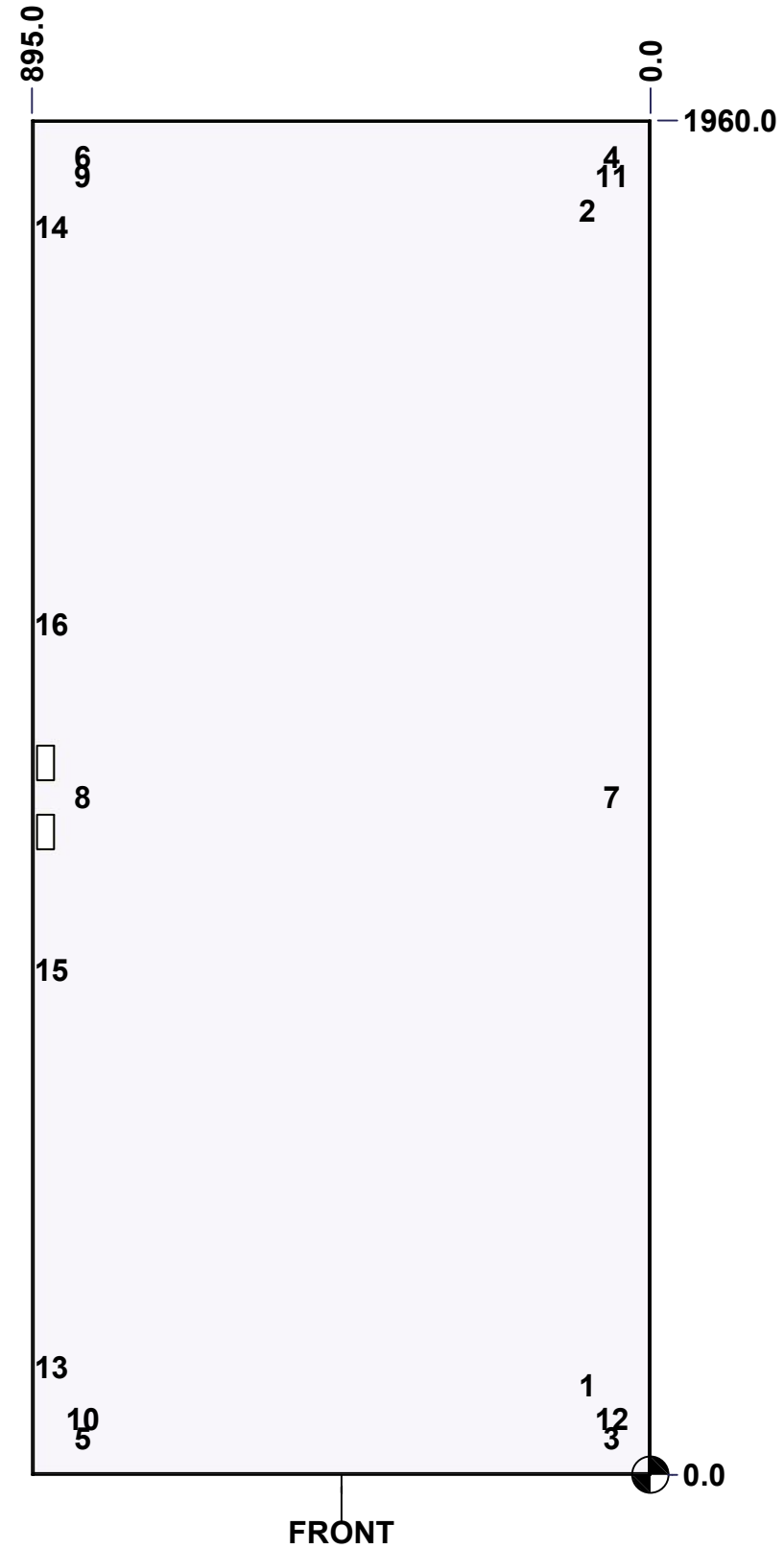

Use bending program path 6500 MX > 6500 MXD

	Description		Status
	6500 MXD 2000mm x 900mm Front		(NULL)
	Part Number Numéro Pièce		Rev.
	<b>6500MXK200905F</b>		<b>0</b> / 15
			18

This drawing is confidential and must not be reproduced or used without the consent of EXM

Ce dessin est confidentiel et ne doit pas être reproduit ou utilisé sans le consentement de EXM

No.	Revisions	Date	By/Par

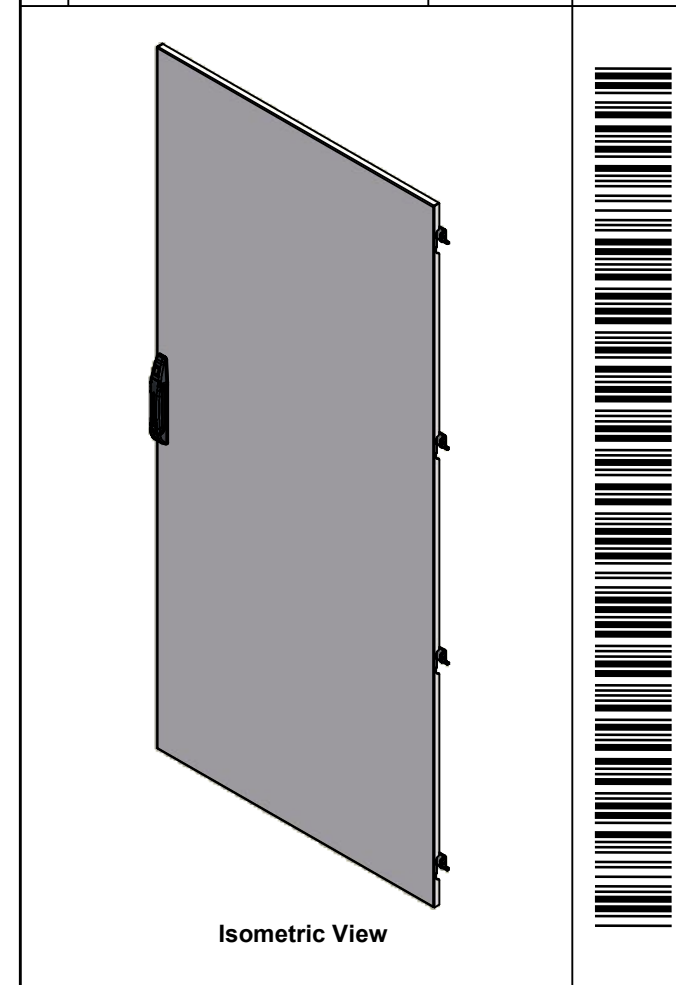

**EXM**  
www.exmweb.com

Tél: (450) 979-4373  
Fax: (450) 979-4626

Flatness  
Aplatissement  
Max 3.0mm

Projection

1	STK-P-03820R	0	Powder Paint (Light Grey / Rough Textured)
1	STK-Q-45652-20	5	6500 MX - Lower Closing Bar 2000mm
1	STK-Q-45651-20	5	6500 MX - Upper Closing Bar 2000mm
1	6500MXSRK	1	6500 MXRSK Door Support Roller
4	STK-Q-16405	6	Guide Stud - Small (No Paint Cap Required)
4	STK-K-06810	7	6500 MX Hinge Assy
1	886PHD-S	11	Euroform Pull Handle Kit
12	STK-Q-16055	1	M6 x 18mm Stud (No Paint Cap Required)
1	6500MXK200905DS1	5	6500 MX 2000mm x 900mm Door Stiffener
1	6500MXK200905FG	0	6500 MXD 2000mm x 900mm Front Gasket
1	6500MXK200905F-P	0	6500 MXD 2000mm x 900mm Front Part
Qty	Part Number	Rev	Description
Parts List			

Customer Client

Drawn By / Dessiné Par: BoxCad: BoxCad

Material / Matière: 14 Ga Cold Rolled A1008 CS Type B

Color / Couleur: Light Grey RAL7035

Finish / Fini: Rough Textured

Description: 6500 MXD 2000mm x 900mm Front

Part Number / Numéro Pièce: **6500MXK200905F**

Date: 8/8/2014

Detail Rev.:

Rev.	16
<b>0</b>	18



This drawing is confidential and must not be reproduced or used without the consent of EXM

Ce dessin est confidentiel et ne doit pas être reproduit ou utilisé sans le consentement de EXM

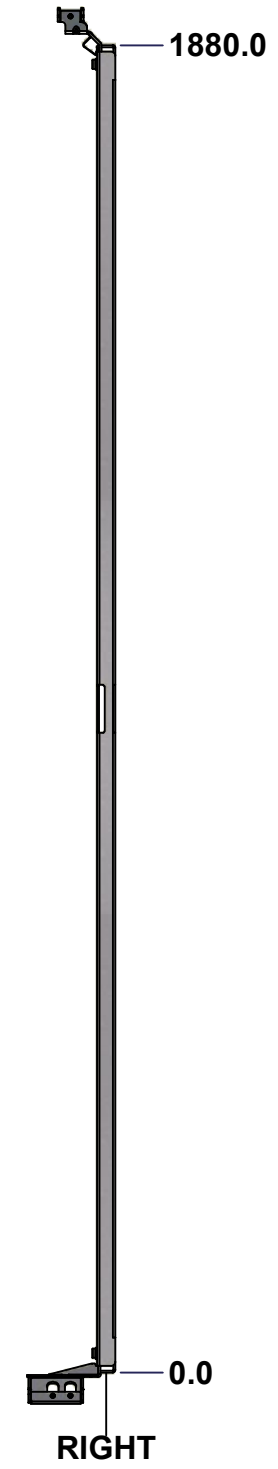
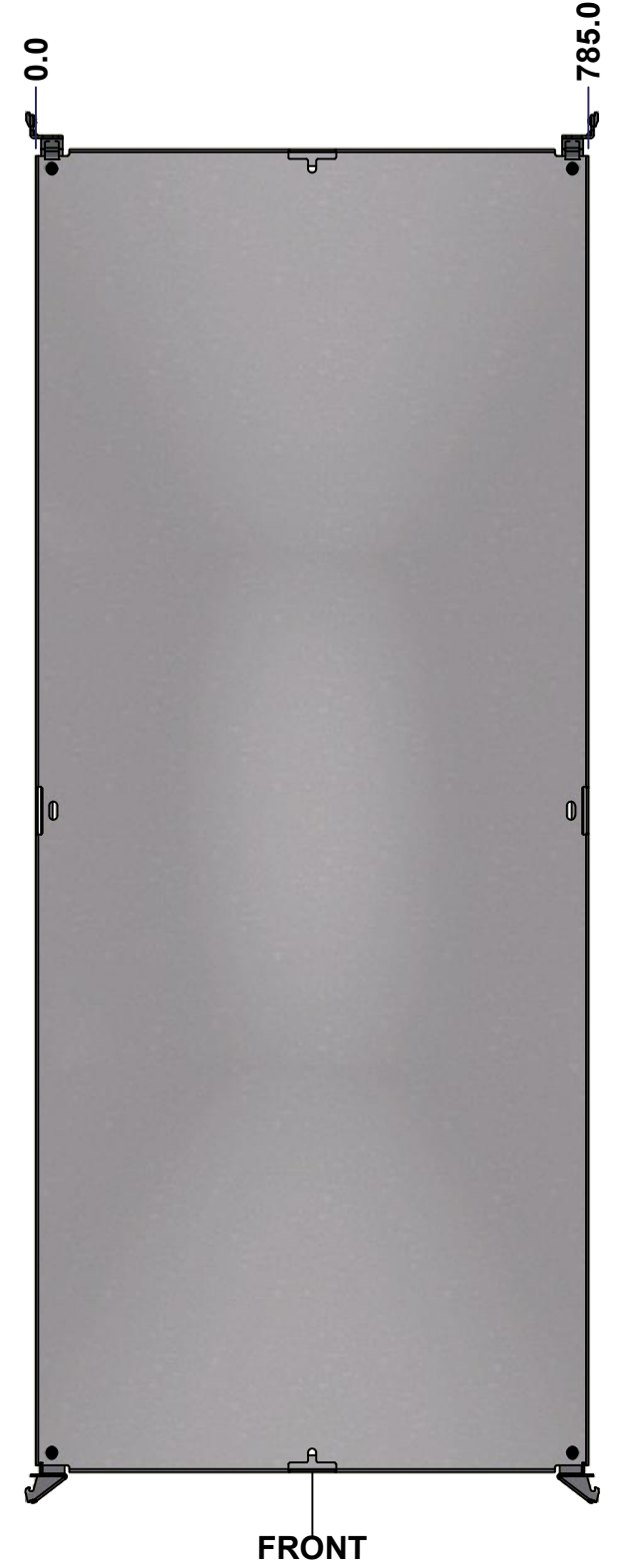
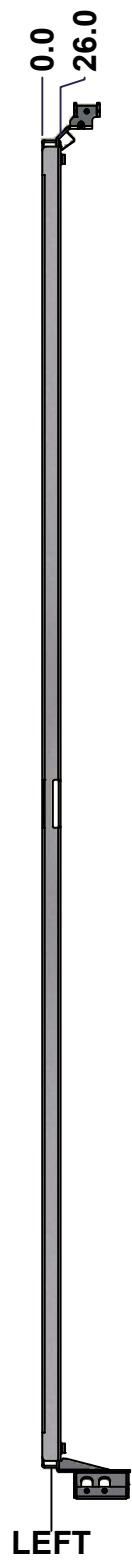
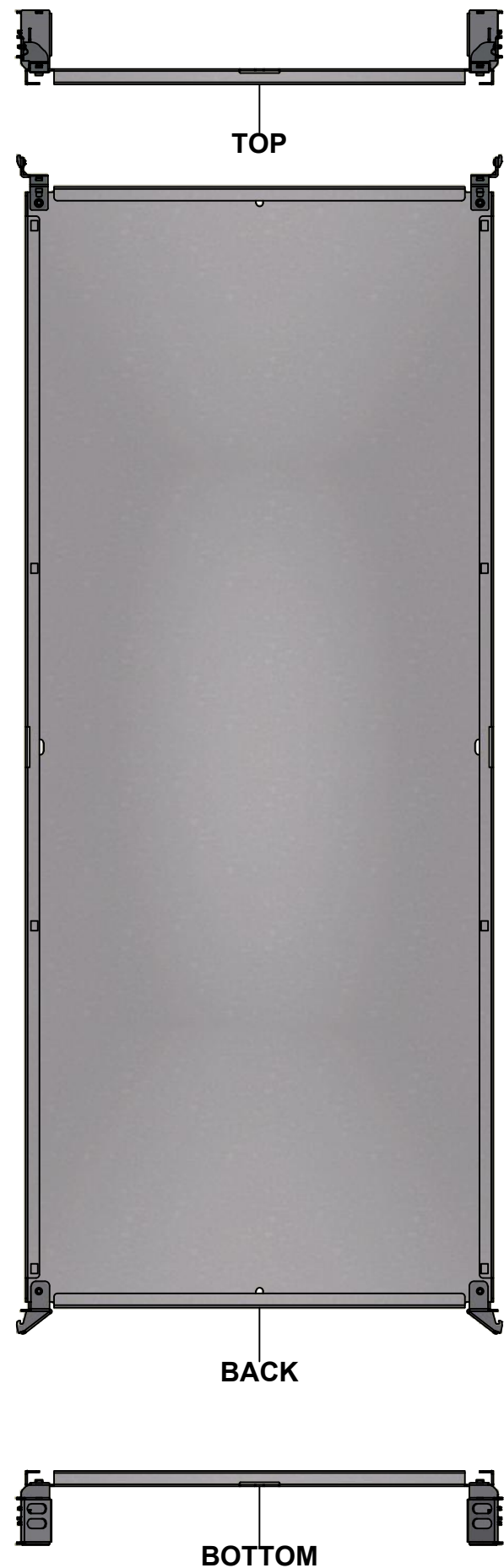

No.	Revisions	Date	By/Par

**Isometric View**

Tél: (450) 979-4373 Fax: (450) 979-4626 <a href="http://www.exmweb.com">www.exmweb.com</a>		Flatness Aplatissement
		Max 3.0mm
Customer Client		Date
Drawn By Dessiné Par BoxCad: BoxCad		Date 8/8/2014
Material Matière 12 Ga Galvanized (2.5mm)		
Color Couleur Unpainted	Finish Fini Unpainted	
Description 6500 MXM 2000mm x 900mm Back Inner Panel		Detail Rev.
Part Number Numéro Pièce <b>6500MXK200905BIP</b>		Rev. 17 <b>0</b> 18

**SEE BILL OF MATERIAL ON LAST PAGE**

This drawing is confidential and must not be reproduced or used without the consent of EXM

Ce dessin est confidentiel et ne doit pas être reproduit ou utilisé sans le consentement de EXM

No.	Revisions	Date	By/Par

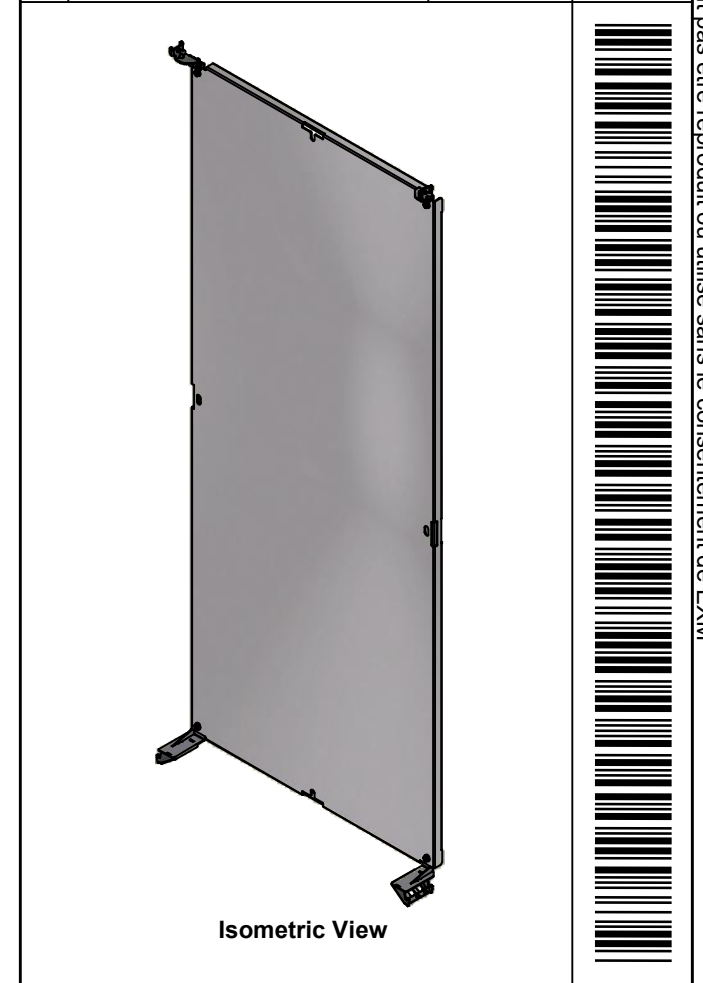

Tél: (450) 979-4373 Fax: (450) 979-4626 <a href="http://www.exmweb.com">www.exmweb.com</a>		Flatness Aplatissement
		Max 3.0mm
Customer Client		Date
Drawn By Dessiné Par BoxCad: BoxCad		Date 8/8/2014
Material Matière 12 Ga Galvanized (2.5mm)		
Color Couleur Unpainted	Finish Fini Unpainted	
Description 6500 MXM 2000mm x 900mm Back Inner Panel		Detail Rev.
Part Number Numéro Pièce <b>6500MXK200905BIP</b>		Rev. 18 <b>0</b> 18

Qty	Part Number	Rev	Description
1	STK-A-49005	5	6500 MXM - Bottom Inner Panel Support Assembly (Right)
1	STK-A-49000	5	6500 MXM - Bottom Inner Panel Support Assembly (Left)
1	STK-A-49015	0	6500MXM - Top Inner Panel Support Kit (Right)
1	STK-A-49010	0	6500MXM - Top Inner Panel Support Kit (Left)
1	6500MXK200905BIP-P	0	6500 MXM 2000mm x 900mm Back Inner Panel Part
Parts List			