

This drawing is confidential and must not be reproduced or used without the consent of EXM

Ce dessin est confidentiel et ne doit pas être reproduit ou utilisé sans le consentement de EXM

No.	Revisions	Date	By/Par
1		11/03/2015	

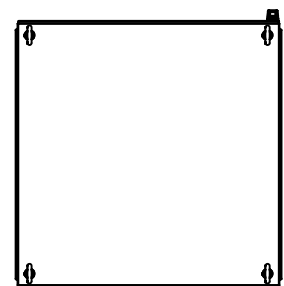

TOP

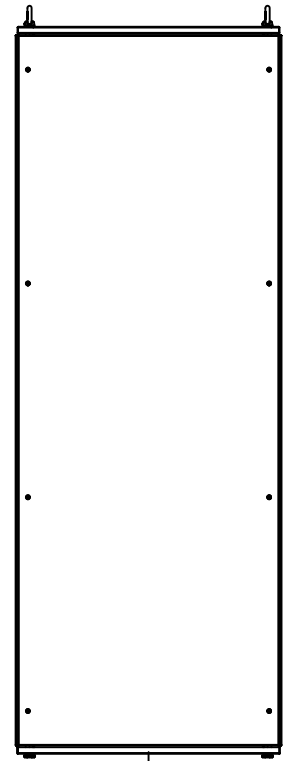

BACK

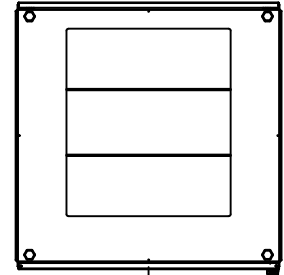

BOTTOM

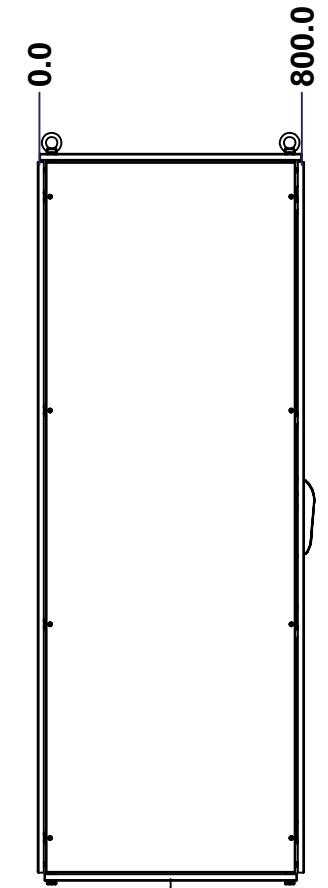

LEFT

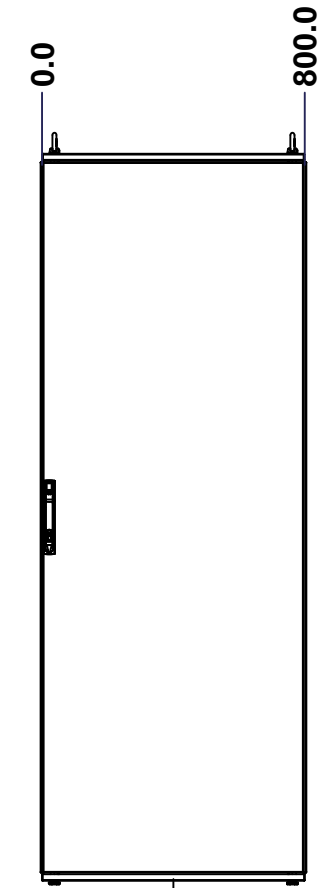

FRONT

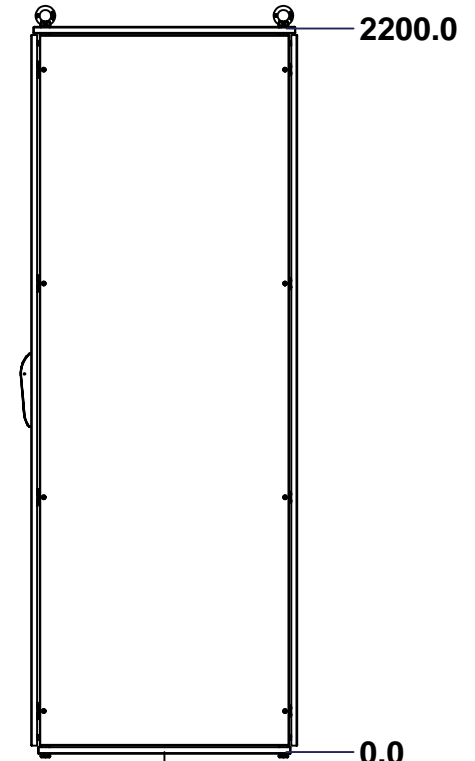

RIGHT

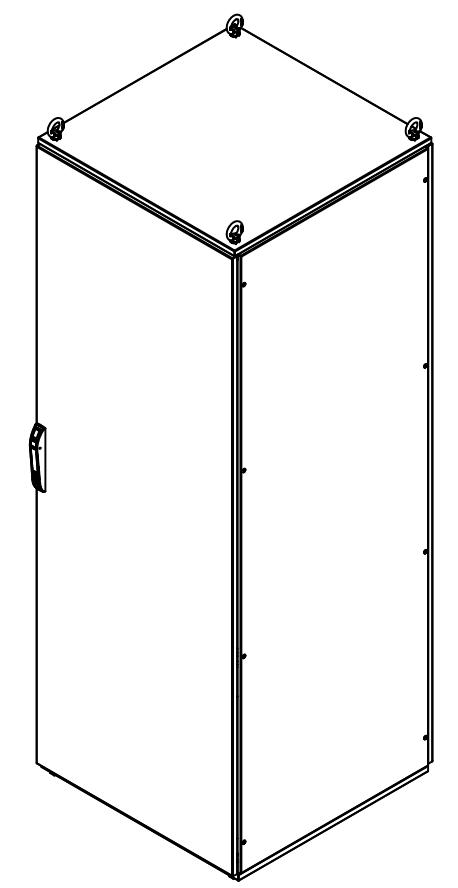

Isometric View

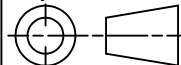

 Tél: (450) 979-4373 Fax: (450) 979-4626 www.exmweb.com		Flatness Aplatissement Max 3.0mm Projection 
Customer Client	Date	
Drawn By Dessiné Par	BoxCad: Annie	Date 25/02/2015
Material Matière	See Part List	
Color Couleur	See Part List	Finish Fini See Part List
Description 6500MX 2200mm x 800mm x 800mm Assembly		Detail Rev.
Part Number Numéro Pièce	Rev. 1	2

SEE BILL OF MATERIAL ON LAST PAGE

6500MXK220808

This drawing is confidential and must not be reproduced or used without the consent of EXM

Ce dessin est confidentiel et ne doit pas être reproduit ou utilisé sans le consentement de EXM

No.	Revisions	Date	By/Par
1		11/03/2015	

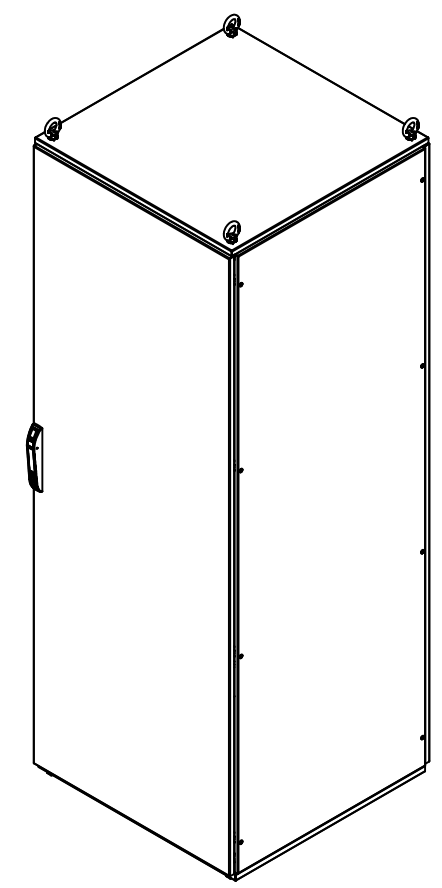

Isometric View



Tél: (450) 979-4373
 Fax: (450) 979-4626
www.exmweb.com

Flatness
Aplatissement
Max 3.0mm
Projection

Customer Client
 Drawn By Dessiné Par BoxCad: Annie
 Date 25/02/2015

Material Matière See Part List

Color Couleur See Part List
 Finish Fini See Part List

Description 6500MX 2200mm x 800mm x 800mm Assembly
 Detail Rev.

Part Number Numéro Pièce
6500MXK220808
 Rev. 1

1	6500MXK220808BIP	1	6500 MXM 2200mm x 800mm Back Inner Panel
1	6500MXK220808R	1	6500 MXC 2200mm x 800mm Right
1	6500MXK220808L	1	6500 MXC 2200mm x 800mm Left
1	6500MXK220808F	1	6500 MXD 2200mm x 800mm Front
1	6500MXK220808B	1	6500 MXR 2200mm x 800mm Back
1	6500MXK220808BT	1	6500 MXB 800mm x 800mm Bottom
1	6500MXK220808T	1	6500 MXT 800mm x 800mm Top
1	6500MXK220808FR	1	6500 MX 2200mm x 800mm x 800mm Frame
Qty	Part Number	Rev	Description
Parts List			

2
1
2

This drawing is confidential and must not be reproduced or used without the consent of EXM

Ce dessin est confidentiel et ne doit pas être reproduit ou utilisé sans le consentement de EXM

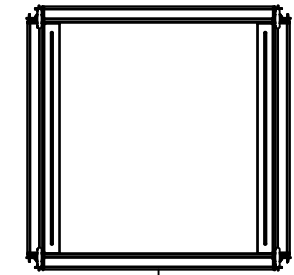

TOP

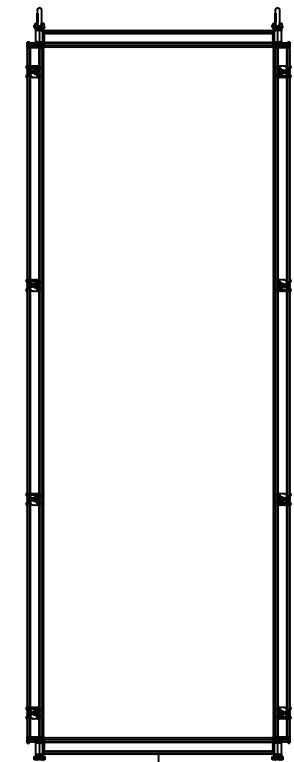

BACK

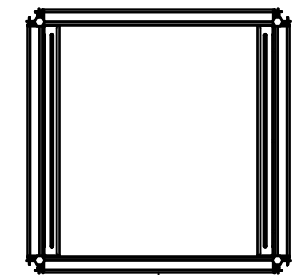

BOTTOM

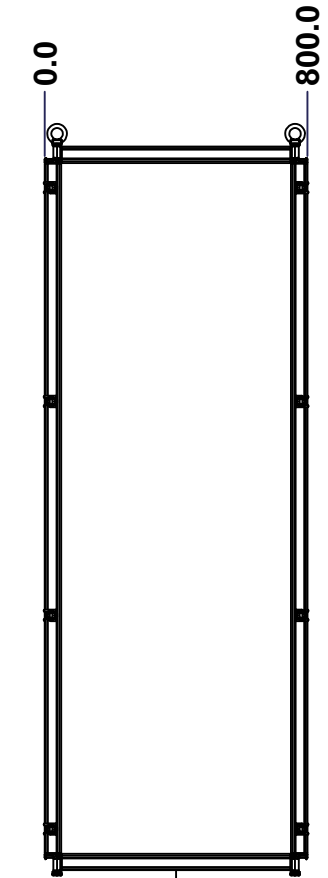

LEFT

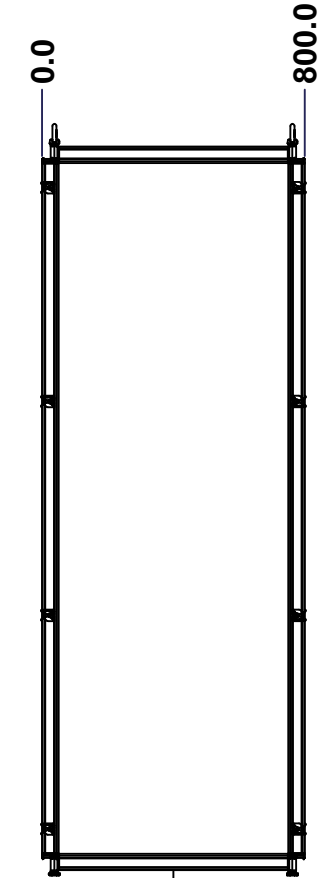

FRONT

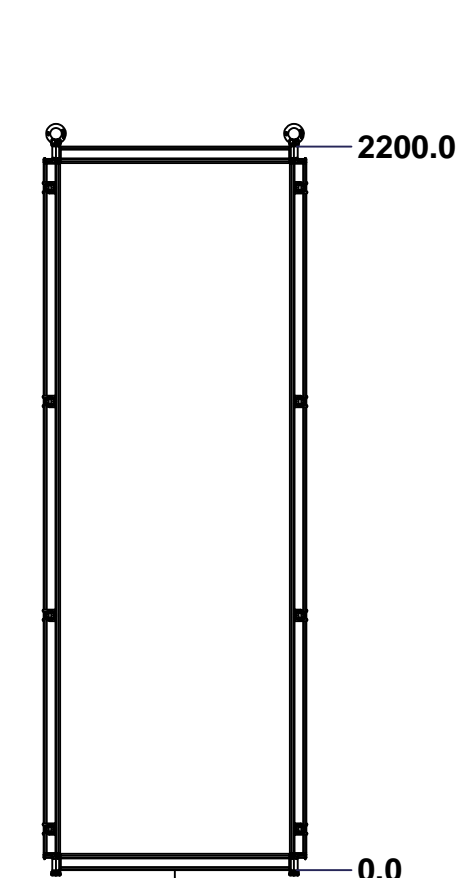

RIGHT

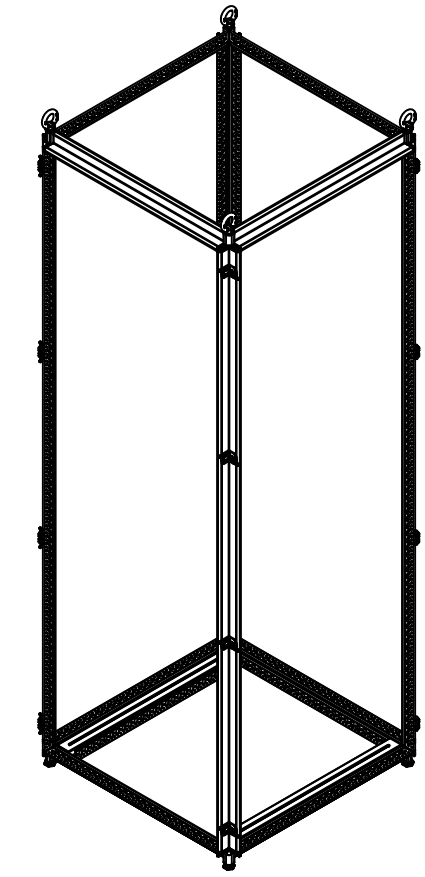

Isometric View

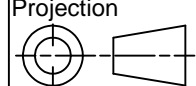

No.	Revisions	Date	By/Par
1		11/03/2015	

 Tél: (450) 979-4373 Fax: (450) 979-4626 www.exmweb.com		Flatness Aplatissement Max 3.0mm Projection 
Customer Client	Date	
Drawn By Dessiné Par	BoxCad: Annie	Date 25/02/2015
Material Matière	16 Ga Electro-Galvanized (1.4mm)	
Color Couleur	Iron Grey RAL7011	Finish Fini Rough Textured
Description	Detail Rev.	
6500 MX 2200mm x 800mm x 800mm Frame		
Part Number Numéro Pièce	Rev.	1
6500MXK220808FR	1	2

SEE BILL OF MATERIAL ON LAST PAGE

This drawing is confidential and must not be reproduced or used without the consent of EXM

Ce dessin est confidentiel et ne doit pas être reproduit ou utilisé sans le consentement de EXM

No.	Revisions	Date	By/Par
1		11/03/2015	

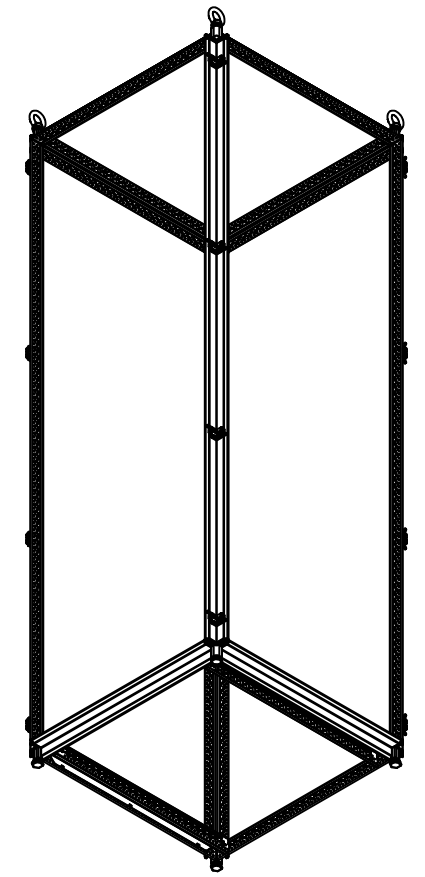

Isometric View

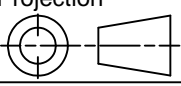

 Tél: (450) 979-4373 Fax: (450) 979-4626 www.exmweb.com		Flatness Aplatissement Max 3.0mm Projection 
Customer Client	Date	
Drawn By Dessiné Par	BoxCad: Annie	Date 25/02/2015
Material Matière	16 Ga Electro-Galvanized (1.4mm)	
Color Couleur	Iron Grey RAL7011	Finish Fini Rough Textured
Description	Detail Rev.	
6500 MX 2200mm x 800mm x 800mm Frame		
Part Number Numéro Pièce	Rev. 1	2
6500MXK220808FR		

Qty	Part Number	Rev	Description
1	STK-P-03810R	0	Powder Paint (Iron Grey / Rough Textured)
1	STK-Q-49065	3	6500 MXM Inner Panel Slider 800mm
1	STK-Q-49065-L	3	6500 MXM Inner Panel Slider 800mm
4	STK-Q-49500	3	M12 Eye Bolt (0.34T)
4	STK-Q-61110	0	M12 Feet Leveler
8	STK-Q-00610	1	M18 x 30.5mm Bolt - Cover
4	STK-Q-47251-22	3	6500 MX 2200mm Vertical Frame Post Part
8	STK-Q-49445	2	6500 MX - Frame Corner Bracket Casting
16	STK-K-11001	2	3 Way Fixed Bracket Kit
8	STK-Q-47250-08	3	6500 MX 800mm Horizontal Frame Post Part
Parts List			

This drawing is confidential and must not be reproduced or used without the consent of EXM

Ce dessin est confidentiel et ne doit pas être reproduit ou utilisé sans le consentement de EXM



TOP

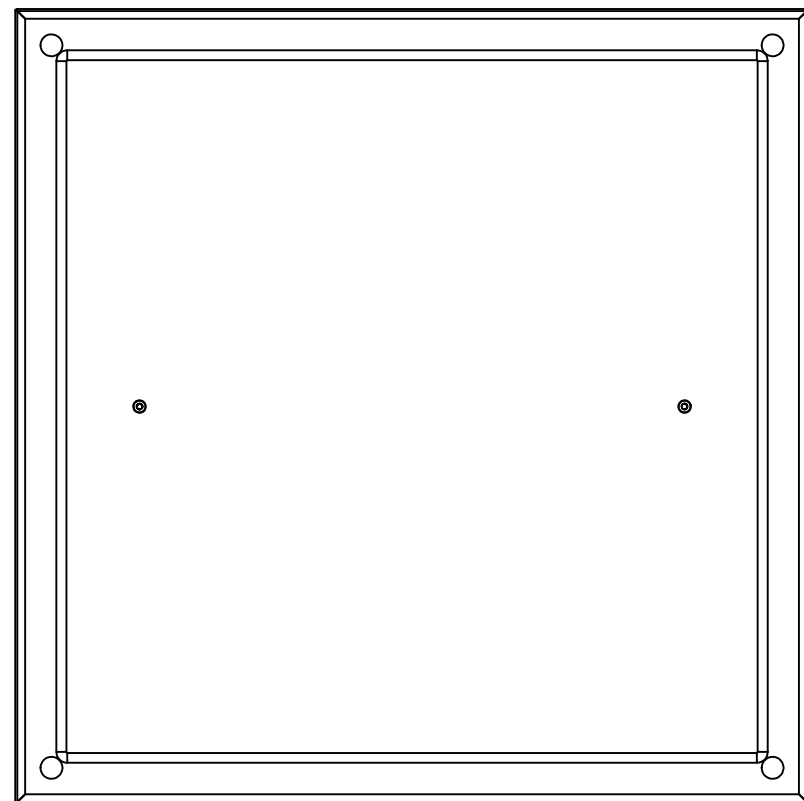

BACK

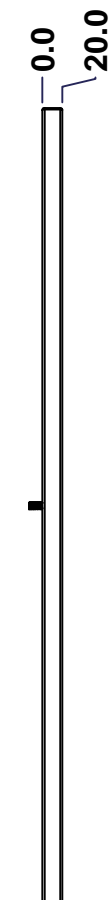

LEFT

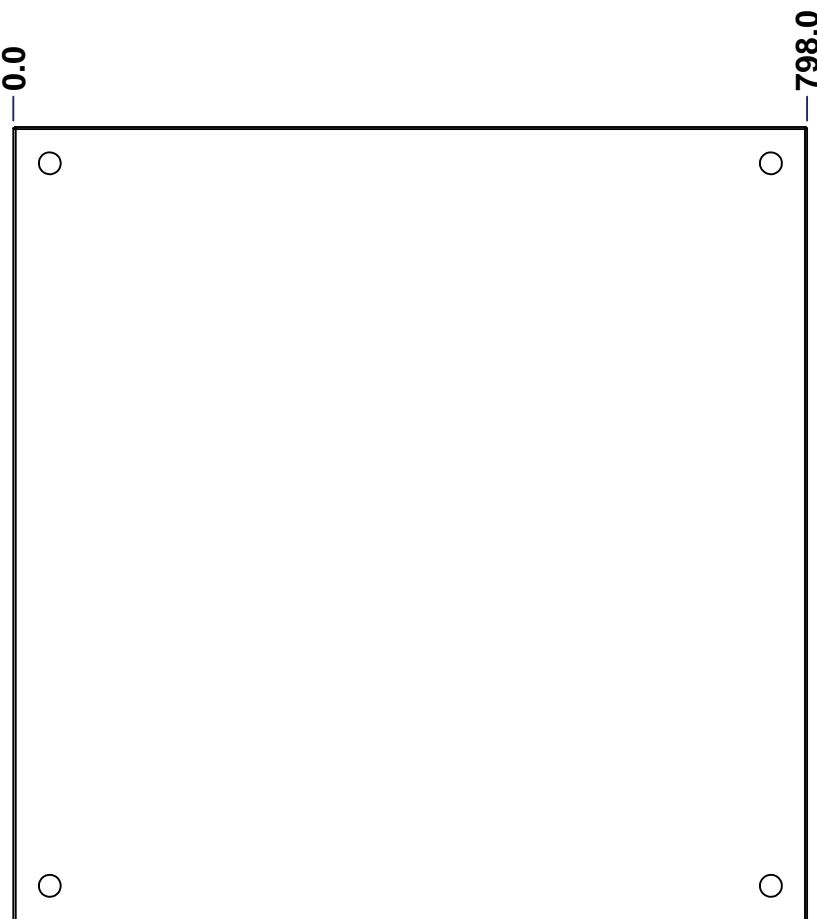

FRONT

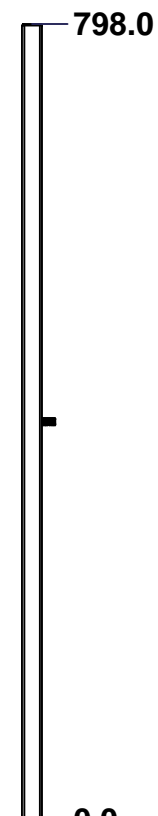

RIGHT



BOTTOM

No.	Revisions	Date	By/Par
1		11/03/2015	

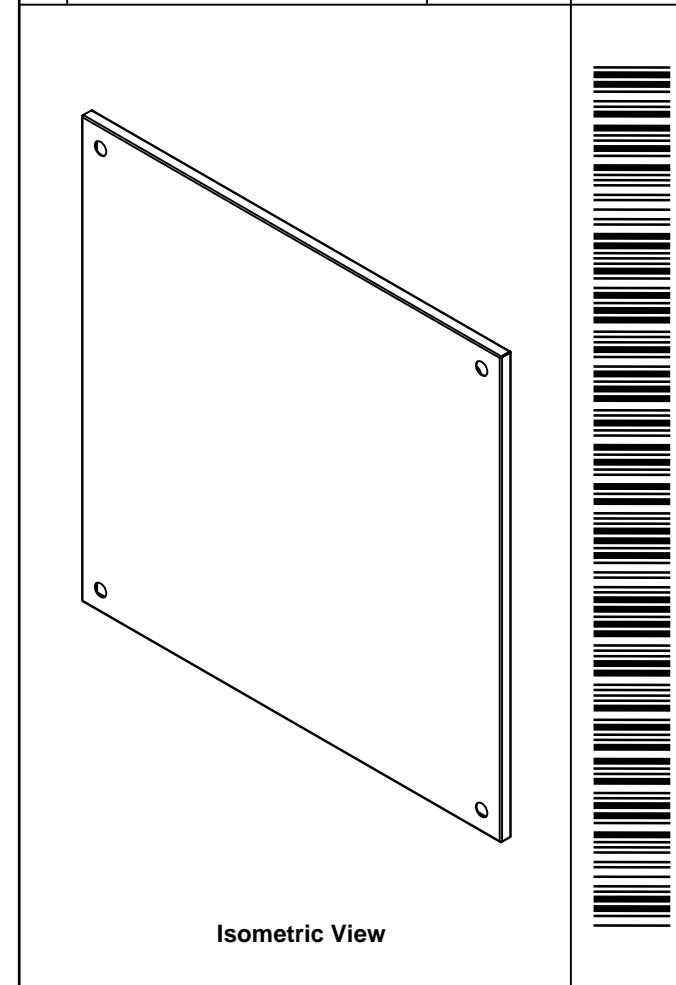

Isometric View

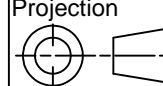
 Tél: (450) 979-4373 Fax: (450) 979-4626 www.exmweb.com		Flatness Aplatissement Max 3.0mm Projection 	
Customer Client		Date	
Drawn By Dessiné Par BoxCad: Annie		Date 25/02/2015	
Material Matière 16 Ga H.R.P. & O. (1.4mm)			
Color Couleur Iron Grey RAL7011		Finish Fini Rough Textured	
Description 6500 MXT 800mm x 800mm Top			Detail Rev.
Part Number Numéro Pièce 6500MXK220808T		Rev. 1	1/3

SEE BILL OF MATERIAL ON LAST PAGE

This drawing is confidential and must not be reproduced or used without the consent of EXM

Ce dessin est confidentiel et ne doit pas être reproduit ou utilisé sans le consentement de EXM

STANDARD FEATURES ARE NOT LISTED IN THIS HOLE TABLE			
HOLE TABLE - FRONT VIEW (CUSTOM FEATURE ONLY)			
CUT-OUT	XDIM	YDIM	DESCRIPTION
1	125.0	399.0	GND STUD M6 x 16mm (Inside)
2	673.0	399.0	GND STUD M6 x 16mm (Inside)

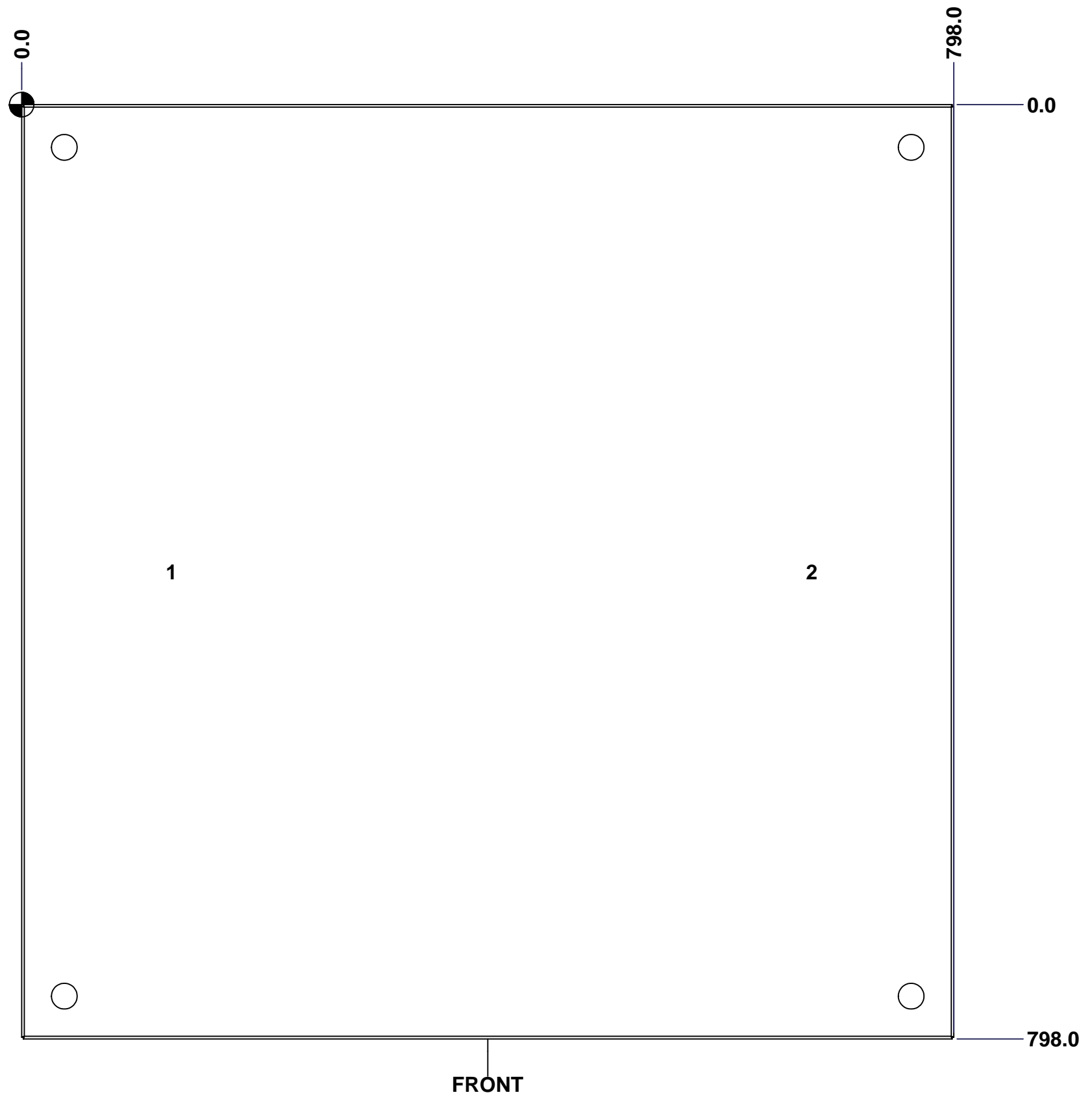



	Description	Status	
	6500 MXT 800mm x 800mm Top	(NULL)	
	Part Number Numéro Pièce	Rev.	
	6500MXK220808T	1	2 3

This drawing is confidential and must not be reproduced or used without the consent of EXM

Ce dessin est confidentiel et ne doit pas être reproduit ou utilisé sans le consentement de EXM

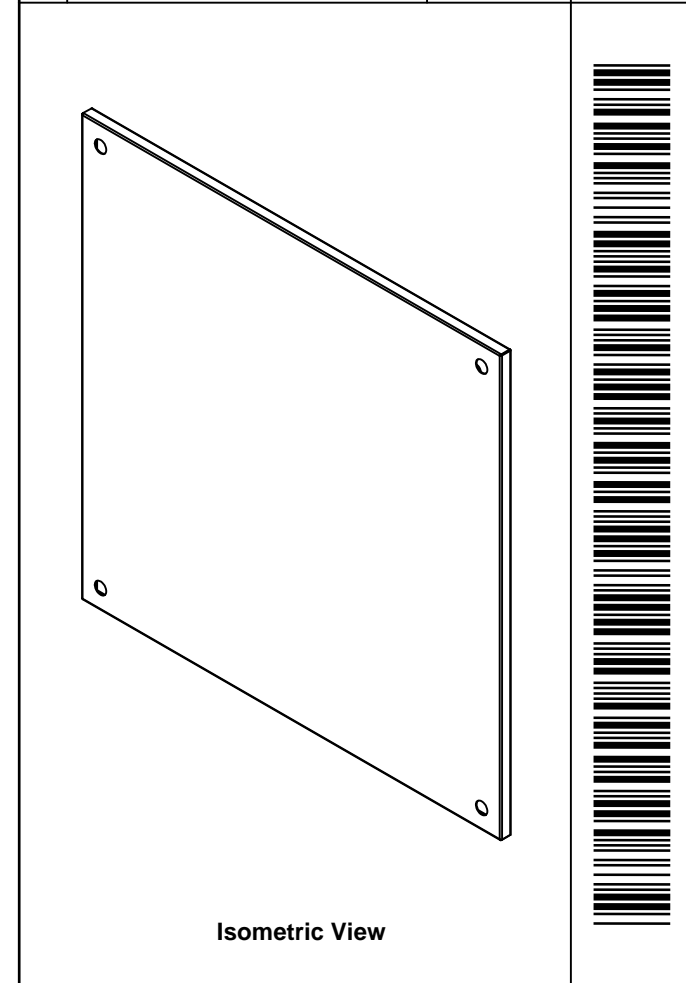
No.	Revisions	Date	By/Par
1		11/03/2015	

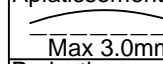
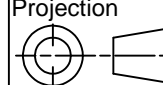

 Tél: (450) 979-4373 Fax: (450) 979-4626 www.exmweb.com		Flatness Aplatissement  Max 3.0mm Projection 
Customer Client	Date	
Drawn By Dessiné Par	BoxCad: Annie	Date 25/02/2015
Material Matière	16 Ga H.R.P. & O. (1.4mm)	
Color Couleur	Iron Grey RAL7011	Finish Fini Rough Textured
Description	Detail Rev.	
6500 MXT 800mm x 800mm Top		
Part Number Numéro Pièce	Rev.	3
6500MXK220808T	1	3

Qty	Part Number	Rev	Description
1	STK-P-03810R	0	Powder Paint (Iron Grey / Rough Textured)
2	STK-Q-16080	0.1.1	M6 x 16mm Ground Stud
1	6500MXK220808TG	1	6500 MXT 800mm x 800mm Top Gasket
1	6500MXK220808T-P	1	6500 MXT 800mm x 800mm Top Part
Parts List			

This drawing is confidential and must not be reproduced or used without the consent of EXM

Ce dessin est confidentiel et ne doit pas être reproduit ou utilisé sans le consentement de EXM

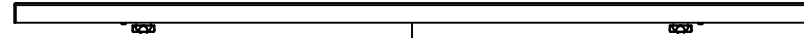

TOP

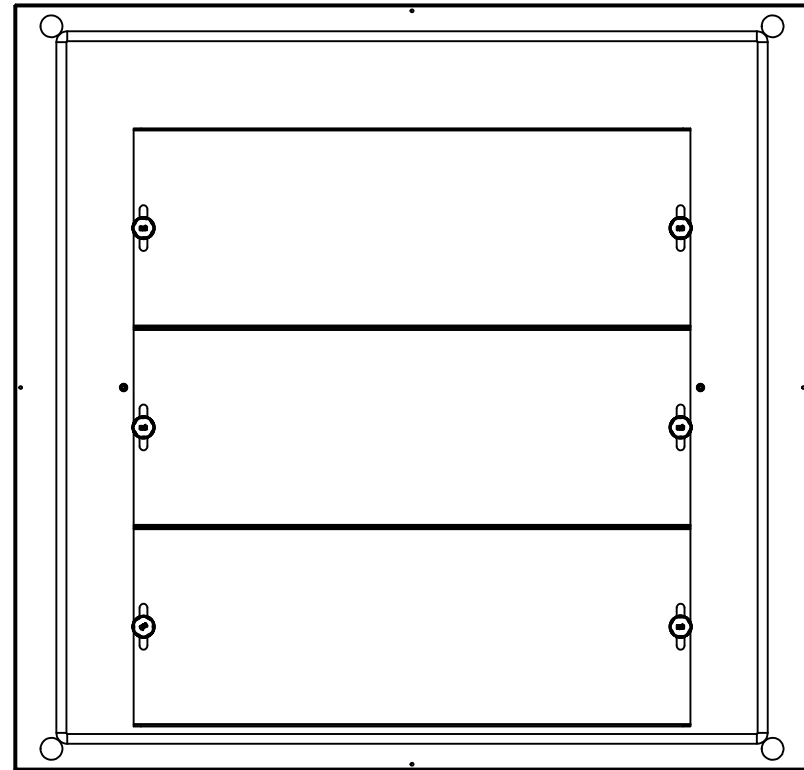

BACK

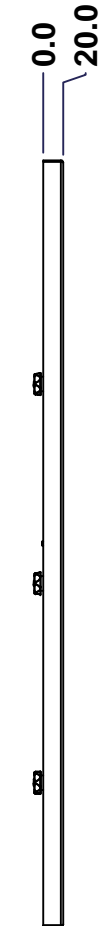

LEFT

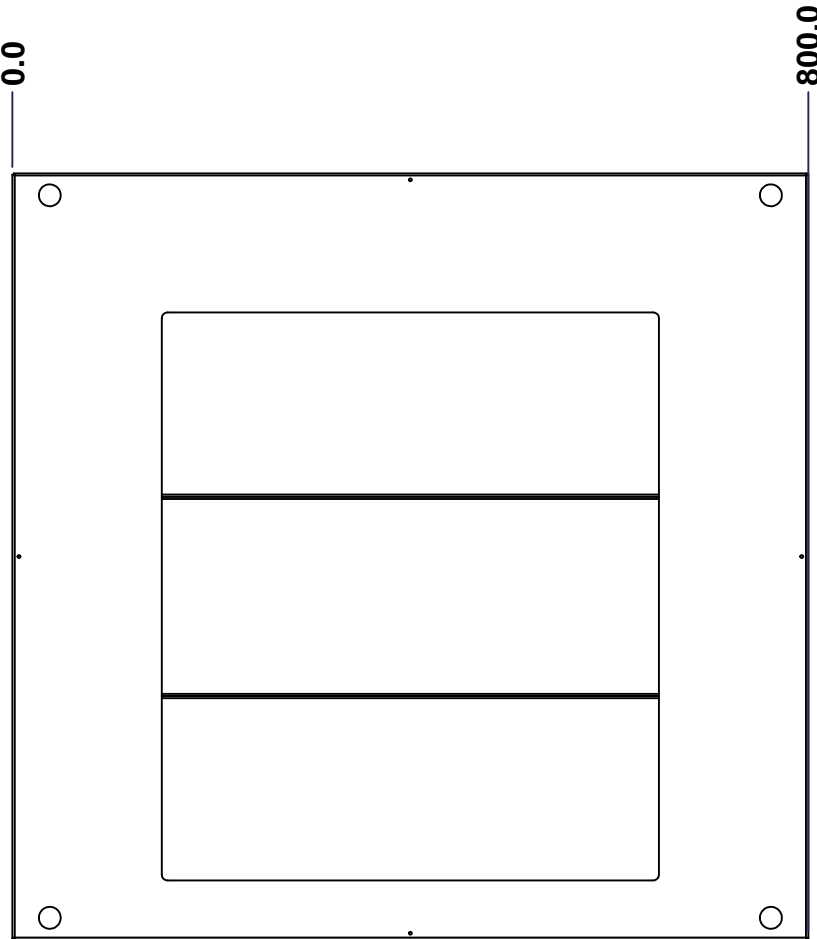

FRONT

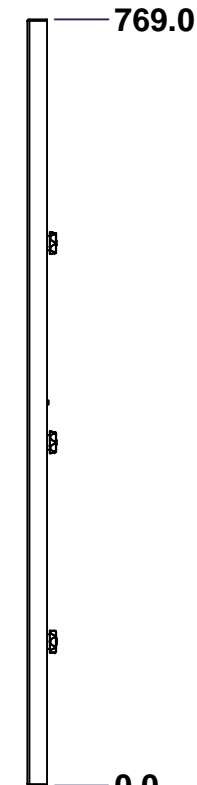

RIGHT

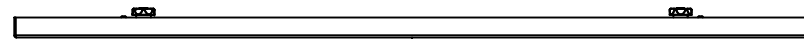

BOTTOM

No.	Revisions	Date	By/Par
1		11/03/2015	

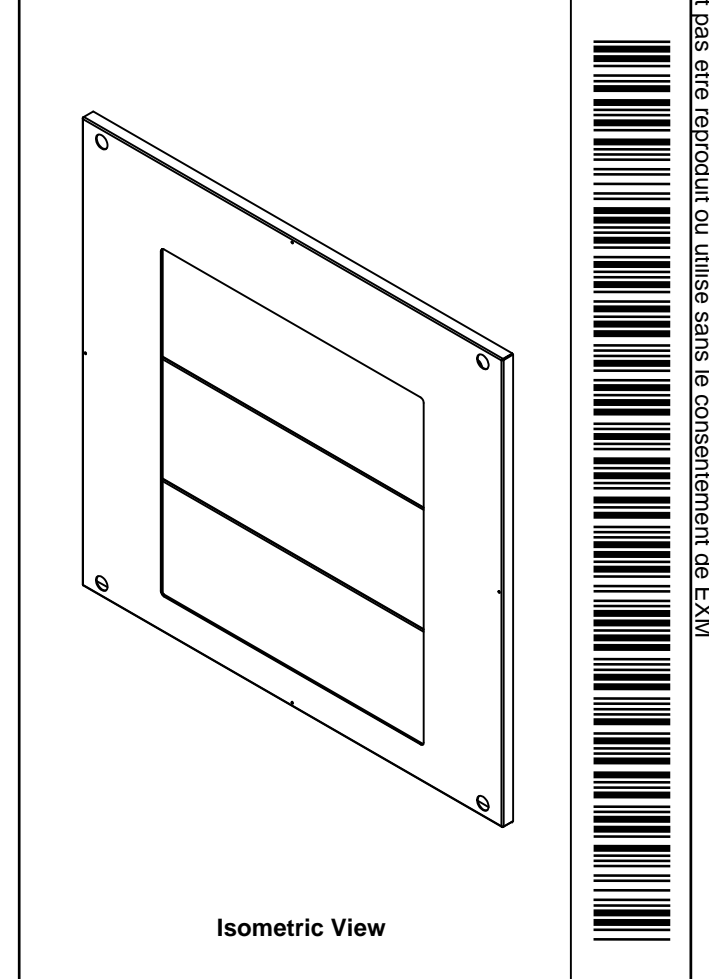

Isometric View

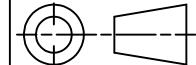
 Tél: (450) 979-4373 Fax: (450) 979-4626 www.exmweb.com		Flatness Aplatissement Max 3.0mm Projection 	
Customer Client		Date	
Drawn By / Dessiné Par: BoxCad: Annie		Date: 25/02/2015	
Material / Matière: 16 Ga H.R.P. & O. (1.4mm)			
Color / Couleur: Iron Grey RAL7011		Finish / Fini: Rough / Textured	
Description: 6500 MXB 800mm x 800mm Bottom			Detail Rev.
Part Number / Numéro Pièce: 6500MXK220808BT		Rev. 1	3

SEE BILL OF MATERIAL ON LAST PAGE

This drawing is confidential and must not be reproduced or used without the consent of EXM

Ce dessin est confidentiel et ne doit pas être reproduit ou utilisé sans le consentement de EXM

STANDARD FEATURES ARE NOT LISTED IN THIS HOLE TABLE

HOLE TABLE - FRONT VIEW (CUSTOM FEATURE ONLY)

CUT-OUT	XDIM	YDIM	DESCRIPTION
1	110.0	384.5	GND STUD M6 x 16mm (Inside)
2	690.0	384.5	GND STUD M6 x 16mm (Inside)
3	130.0	544.5	GP STUD M6 x 10mm (Inside)
4	670.0	544.5	GP STUD M6 x 10mm (Inside)
5	130.0	344.5	GP STUD M6 x 10mm (Inside)
6	670.0	344.5	GP STUD M6 x 10mm (Inside)
7	130.0	144.5	GP STUD M6 x 10mm (Inside)
8	670.0	144.5	GP STUD M6 x 10mm (Inside)

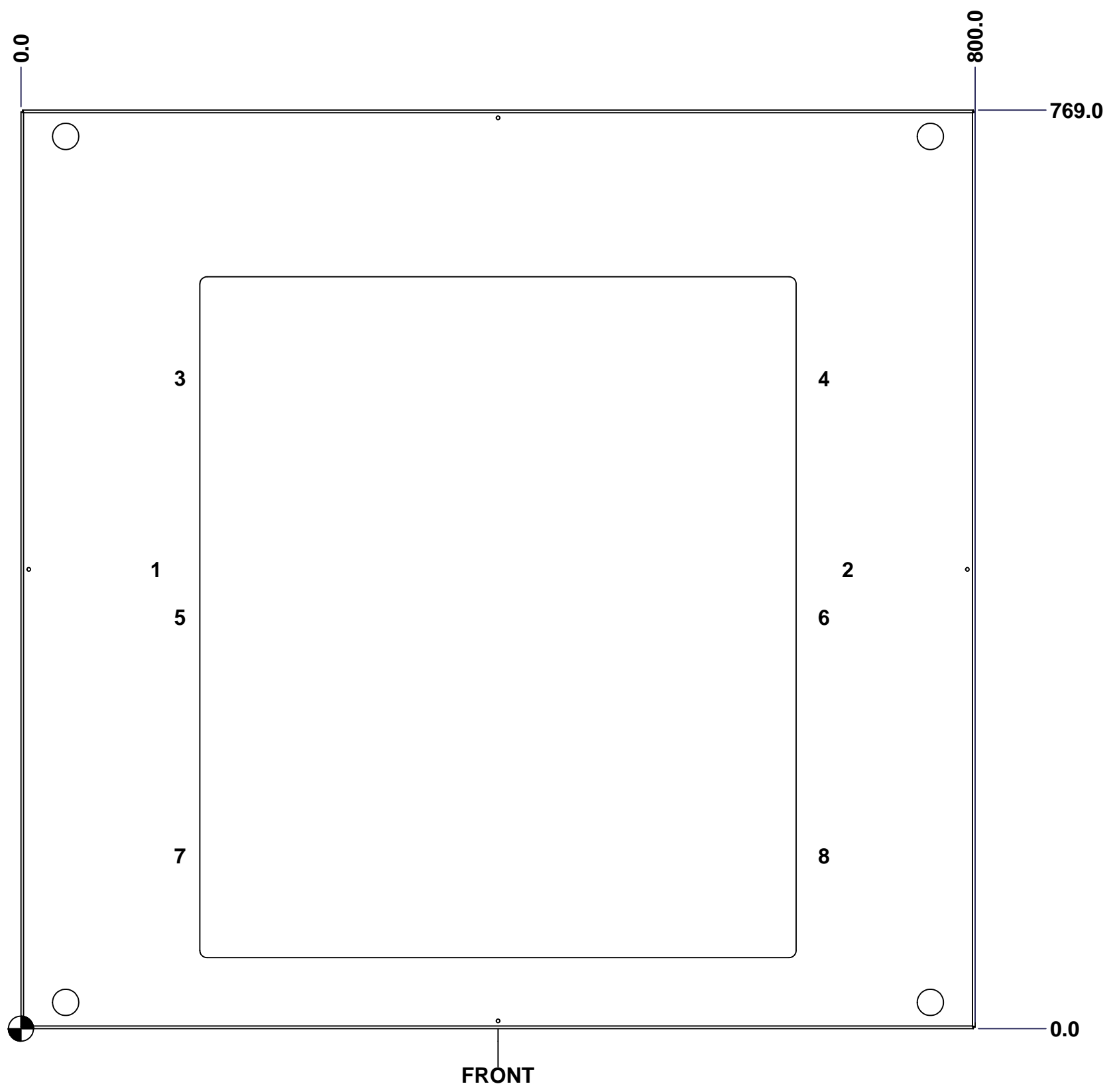

FRONT

	Description	Status	
	6500 MXB 800mm x 800mm Bottom	(NULL)	
	Part Number Numéro Pièce	Rev.	
	6500MXK220808BT	1	2 3

This drawing is confidential and must not be reproduced or used without the consent of EXM

Ce dessin est confidentiel et ne doit pas être reproduit ou utilisé sans le consentement de EXM

No.	Revisions	Date	By/Par
1		11/03/2015	

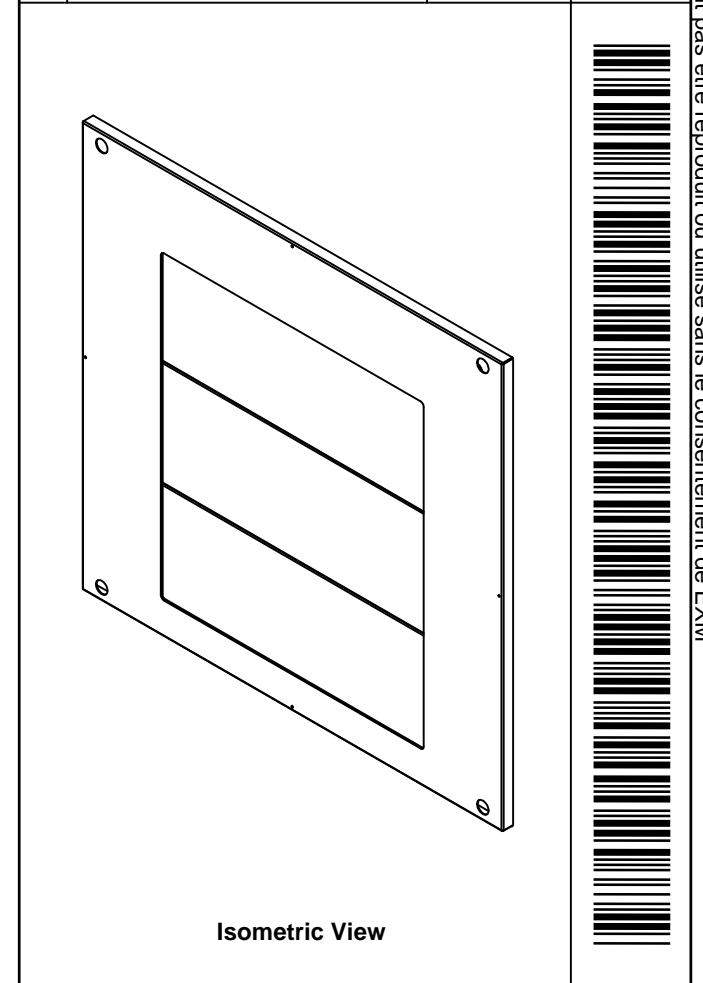

Tél: (450) 979-4373 Fax: (450) 979-4626 www.exmweb.com		Flatness Aplatissement	
		Max 3.0mm Projection	
Customer Client		Date	
Drawn By Dessiné Par BoxCad: Annie		Date 25/02/2015	
Material Matière 16 Ga H.R.P. & O. (1.4mm)			
Color Couleur Iron Grey RAL7011		Finish Fini Rough Textured	
Description 6500 MXB 800mm x 800mm Bottom			Detail Rev.
Part Number Numéro Pièce 6500MXK220808BT		Rev. 1	3 3

Qty	Part Number	Rev	Description
1	STK-P-03810R	0	Powder Paint (Iron Grey / Rough Textured)
6	STK-Q-06001	0	Mtrx - Gland Plate M6 Plastic Thumb Nut
2	STK-Q-16055	1	M6 x 18mm Stud (No Paint Cap Required)
3	6500MXK220808GP200-P	1	6500 MXB 800mm Gland Plate Part (200mm)
6	STK-Q-16031	0	M6 x 10mm Stud (No Paint Cap Required)
1	6500MXK220808BTGPG	1	6500 MXB 800mm x 800mm Bottom Gland Plate Gasket
1	6500MXK220808BTG	1	6500 MXB 800mm x 800mm Bottom Gasket
1	6500MXK220808BT-P	1	6500 MXB 800mm x 800mm Bottom Part
Parts List			

This drawing is confidential and must not be reproduced or used without the consent of EXM

Ce dessin est confidentiel et ne doit pas être reproduit ou utilisé sans le consentement de EXM

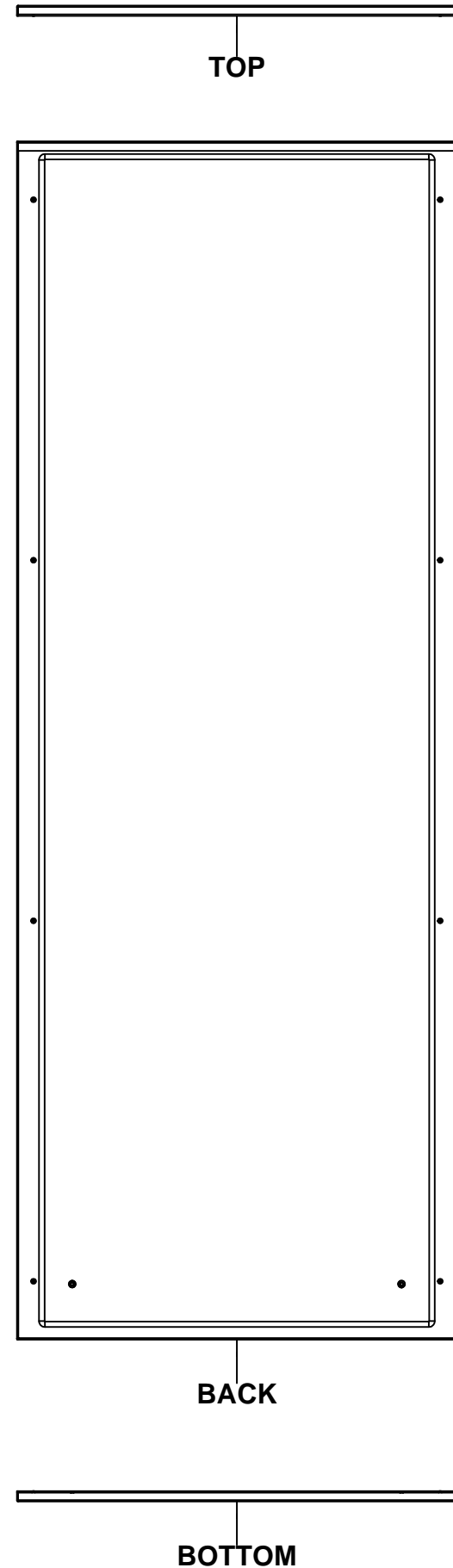

No.	Revisions	Date	By/Par
1		11/03/2015	

Isometric View

		Flatness Aplatissement Max 3.0mm	
Tél: (450) 979-4373 Fax: (450) 979-4626 www.exmweb.com		Projection 	
Customer Client		Date	
Drawn By Dessiné Par BoxCad: Annie		Date 25/02/2015	
Material Matière		14 Ga H.R.P. & O. (1.7mm)	
Color Couleur	Light Grey RAL7035	Finish Fini	Rough Textured
Description		Detail Rev.	
6500 MXR 2200mm x 800mm Back			
Part Number Numéro Pièce		Rev.	1
6500MXK220808B		1	3

SEE BILL OF MATERIAL ON LAST PAGE

This drawing is confidential and must not be reproduced or used without the consent of EXM

Ce dessin est confidentiel et ne doit pas être reproduit ou utilisé sans le consentement de EXM

STANDARD FEATURES ARE NOT LISTED IN THIS HOLE TABLE			
HOLE TABLE - FRONT VIEW (CUSTOM FEATURE ONLY)			
CUT-OUT	XDIM	YDIM	DESCRIPTION
1	100.0	100.0	GND STUD M6 x 16mm (Inside)
2	695.0	100.0	GND STUD M6 x 16mm (Inside)

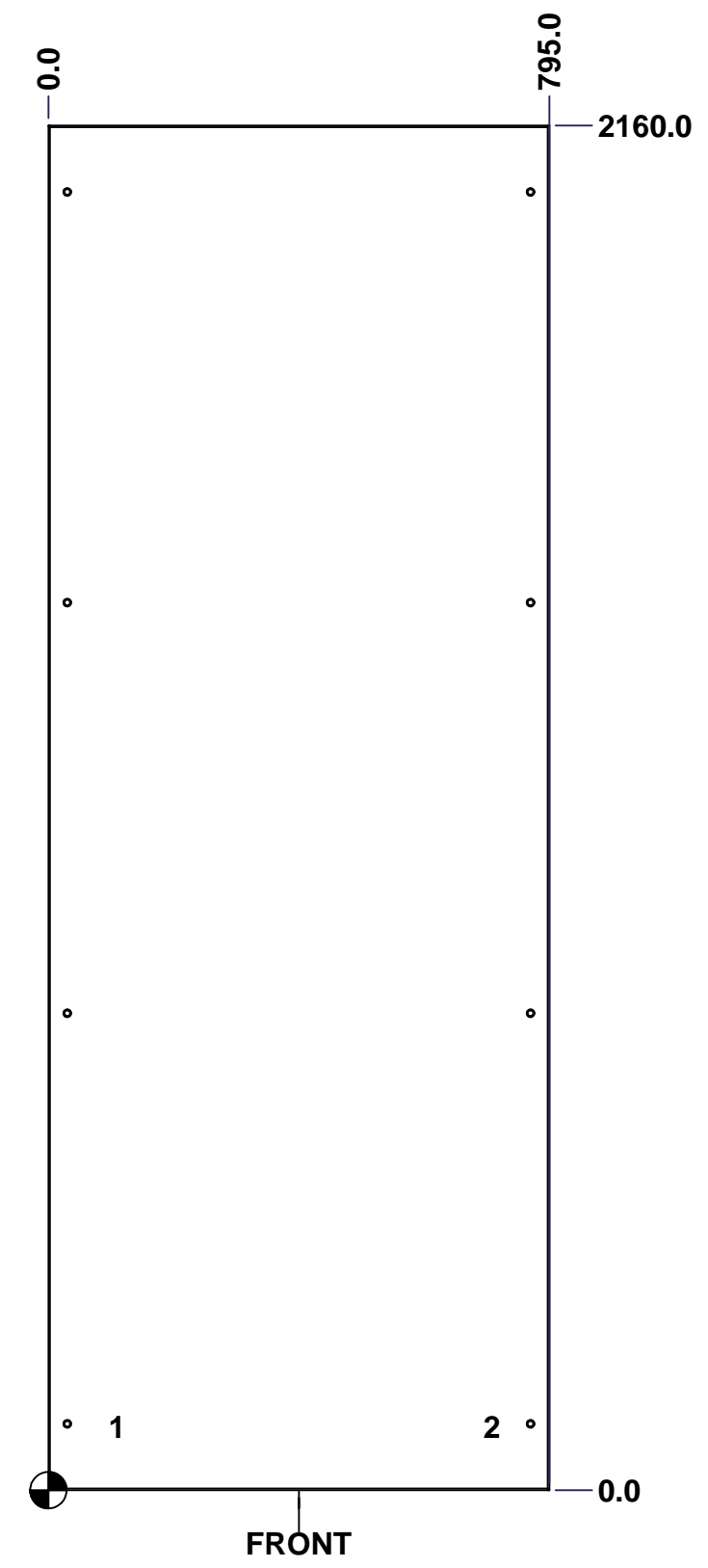



	Description	Status	
	6500 MXR 2200mm x 800mm Back	(NULL)	
	Part Number Numéro Pièce	Rev.	
	6500MXK220808B	1	2 3

This drawing is confidential and must not be reproduced or used without the consent of EXM

Ce dessin est confidentiel et ne doit pas être reproduit ou utilisé sans le consentement de EXM

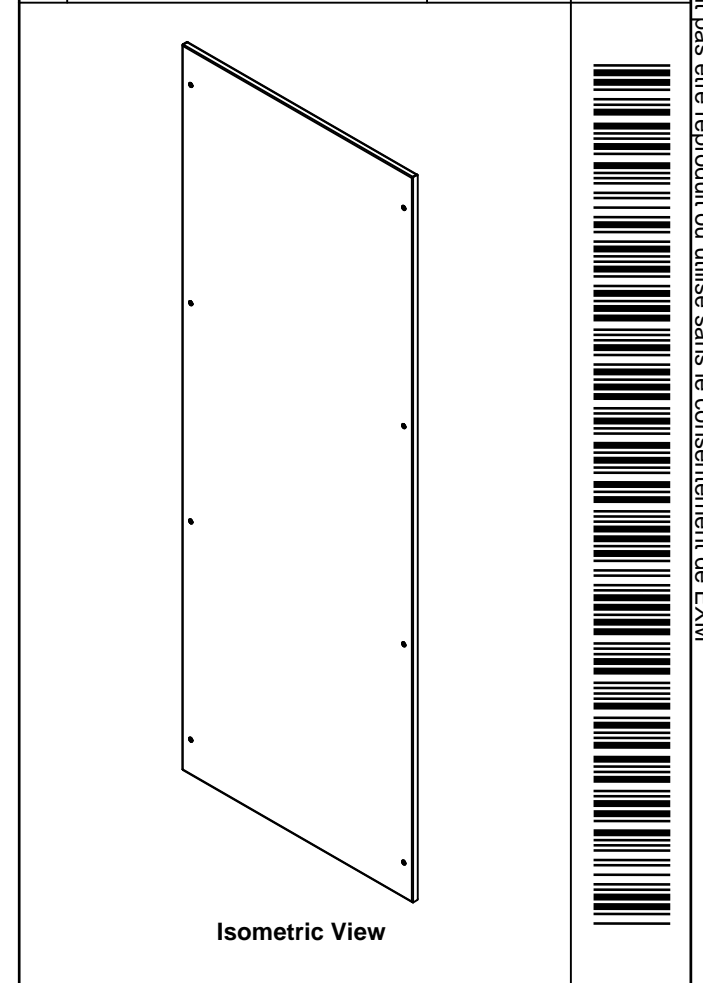
No.	Revisions	Date	By/Par
1		11/03/2015	

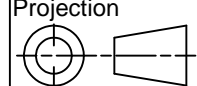

 Tél: (450) 979-4373 Fax: (450) 979-4626 www.exmweb.com		Flatness Aplatissement Max 3.0mm Projection 
Customer Client	Date	
Drawn By Dessiné Par	BoxCad: Annie	Date 25/02/2015
Material Matière	14 Ga H.R.P. & O. (1.7mm)	
Color Couleur	Light Grey RAL7035	Finish Fini Rough Textured
Description	Detail Rev.	
6500 MXR 2200mm x 800mm Back		
Part Number Numéro Pièce	Rev. 3	3
6500MXK220808B		1

Qty	Part Number	Rev	Description
1	STK-P-03820R	0	Powder Paint (Light Grey / Rough Textured)
8	STK-Q-03072	2	M6 x 17mm Phillips Flat Head Screw
2	STK-Q-16080	0.1.1	M6 x 16mm Ground Stud
1	6500MXK220808BG	1	6500 MXR 2200mm x 800mm Back Gasket
1	6500MXK220808B-P	1	6500 MXR 2200mm x 800mm Back Part
Parts List			

This drawing is confidential and must not be reproduced or used without the consent of EXM

Ce dessin est confidentiel et ne doit pas être reproduit ou utilisé sans le consentement de EXM

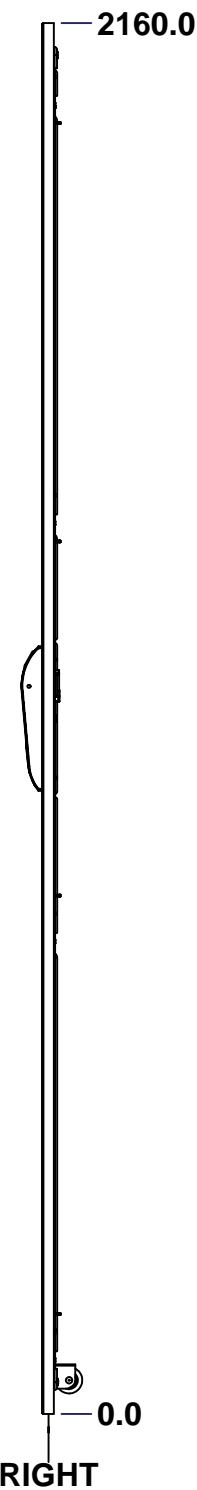
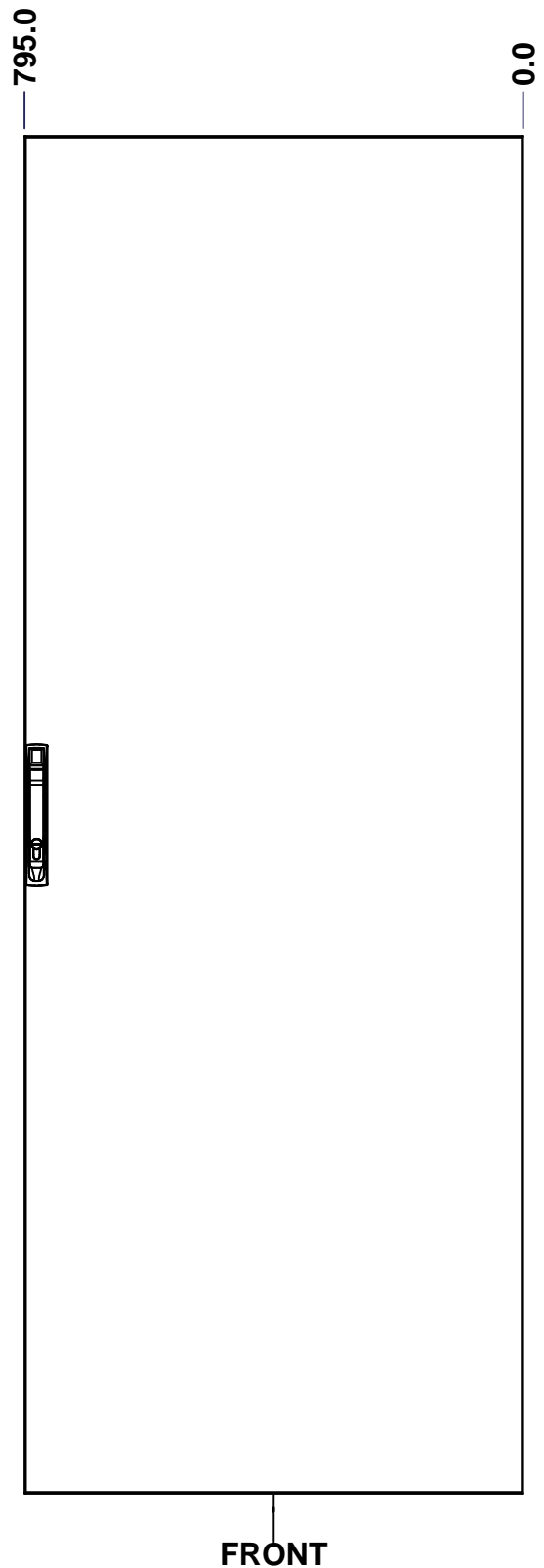
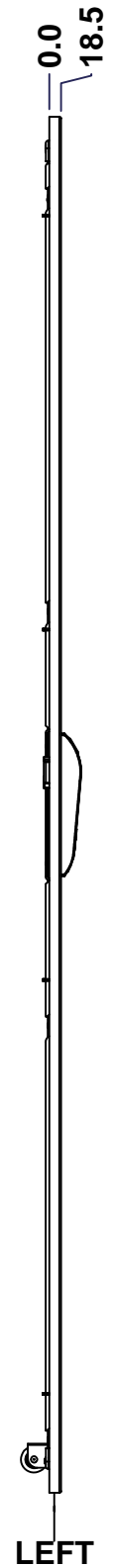
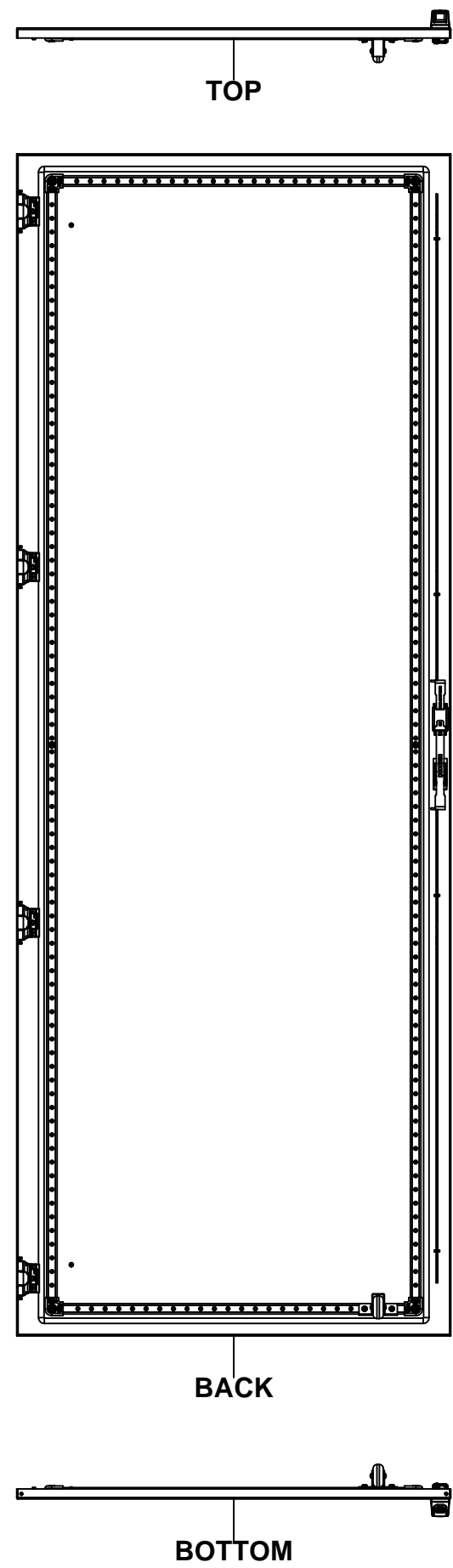

No.	Revisions	Date	By/Par
1		11/03/2015	

Isometric View

Tél: (450) 979-4373 Fax: (450) 979-4626 www.exmweb.com		Flatness Aplatissement	
		Max 3.0mm	
Customer Client		Projection	
Date			
Drawn By Dessiné Par BoxCad: Annie		Date 25/02/2015	
Material Matière 14 Ga H.R.P. & O. (1.7mm)			
Color Couleur Light Grey RAL7035		Finish Fini Rough Textured	
Description 6500 MXD 2200mm x 800mm Front		Detail Rev.	
Part Number Numéro Pièce 6500MXK220808F		Rev. 1	1 / 3

SEE BILL OF MATERIAL ON LAST PAGE

This drawing is confidential and must not be reproduced or used without the consent of EXM

Ce dessin est confidentiel et ne doit pas être reproduit ou utilisé sans le consentement de EXM

STANDARD FEATURES ARE NOT LISTED IN THIS HOLE TABLE

HOLE TABLE - FRONT VIEW (CUSTOM FEATURE ONLY)

CUT-OUT	XDIM	YDIM	DESCRIPTION
1	100.0	130.0	GND STUD M6 x 16mm (Inside)
2	100.0	2030.0	GND STUD M6 x 16mm (Inside)
3	64.5	49.5	STIFF. STUD M6 x 18mm (Inside)
4	64.5	1080.0	STIFF. STUD M6 x 18mm (Inside)
5	64.5	2110.5	STIFF. STUD M6 x 18mm (Inside)
6	730.5	49.5	STIFF. STUD M6 x 18mm (Inside)
7	730.5	1080.0	STIFF. STUD M6 x 18mm (Inside)
8	730.5	2110.5	STIFF. STUD M6 x 18mm (Inside)
9	769.5	155.0	CLOSING BAR GUIDE (Inside)
10	769.5	2005.0	CLOSING BAR GUIDE (Inside)
11	769.5	805.0	CLOSING BAR GUIDE (Inside)
12	769.5	1355.0	CLOSING BAR GUIDE (Inside)

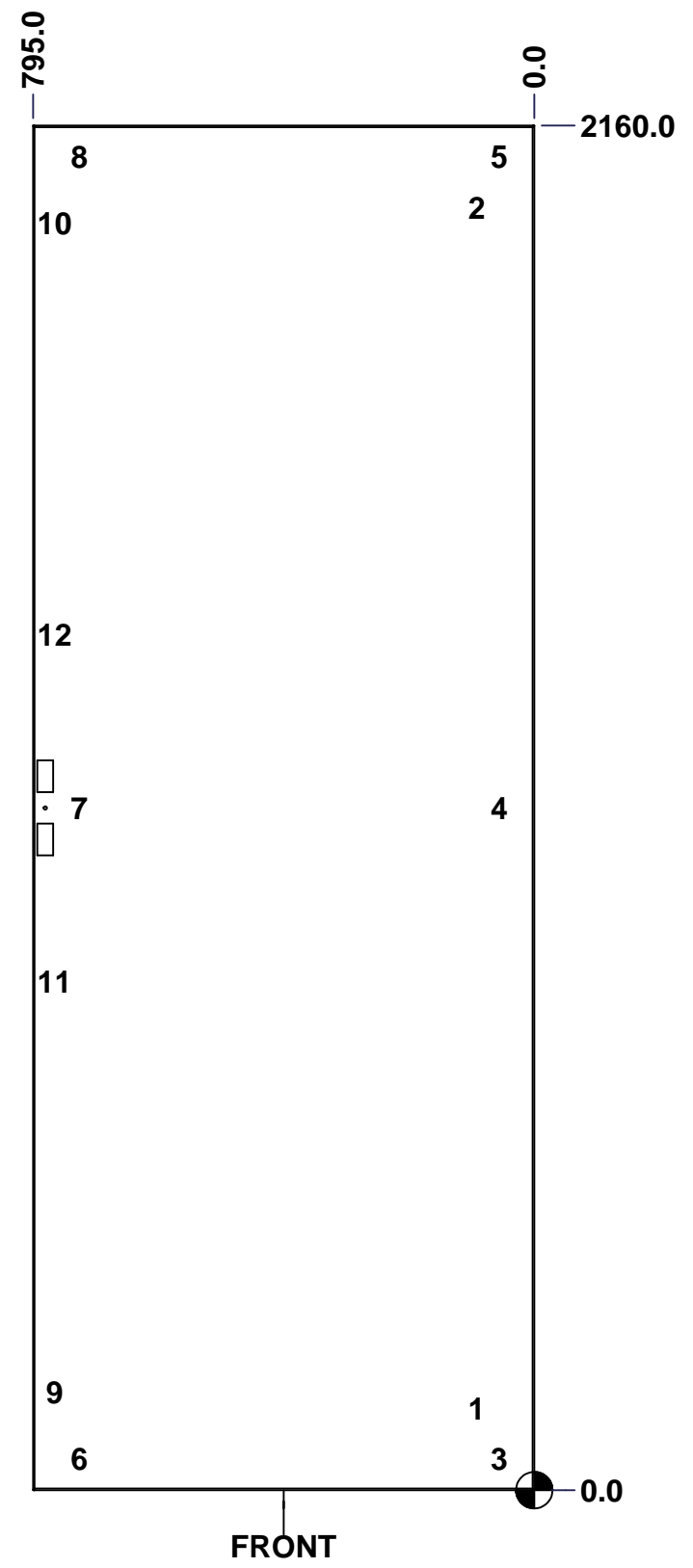

	Description 6500 MXD 2200mm x 800mm Front	Status (NULL)
	Part Number Numéro Pièce 6500MXK220808F	Rev. 1

2	3
1	

This drawing is confidential and must not be reproduced or used without the consent of EXM

Ce dessin est confidentiel et ne doit pas être reproduit ou utilisé sans le consentement de EXM

No.	Revisions	Date	By/Par
1		11/03/2015	

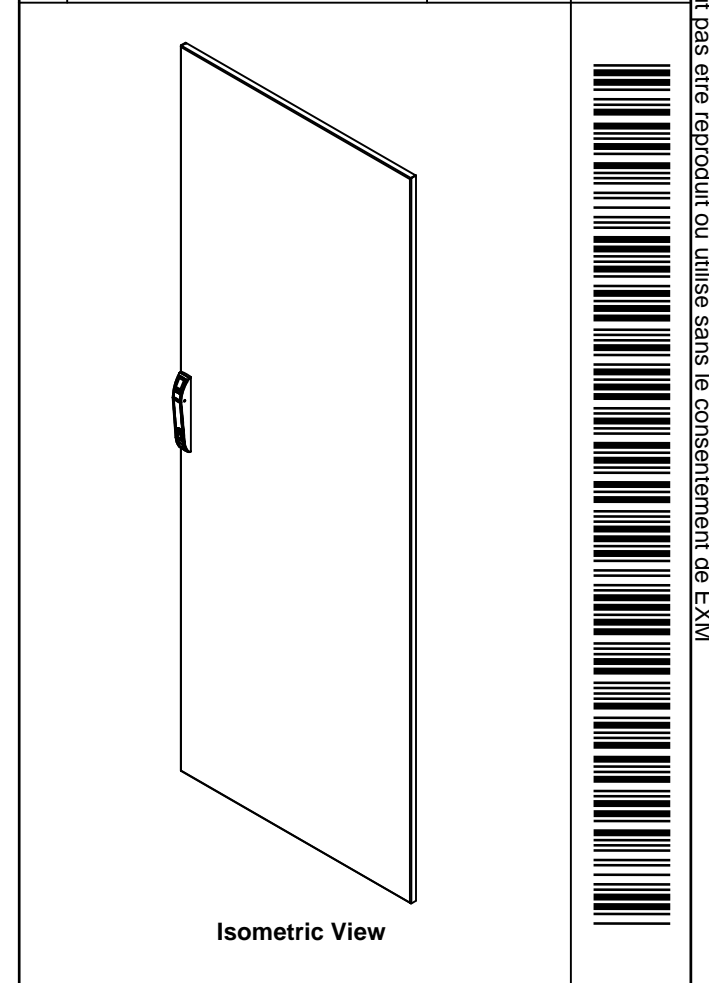

1	STK-P-03820R	0	Powder Paint (Light Grey / Rough Textured)
1	6500MXSRK	1	6500 MXRSK Door Support Roller
4	STK-Q-78022	0	Mtrx Closing Bar Slider
1	STK-Q-45746-22	1	6500 MXD - Lock Door Closing Bar
4	STK-Q-33105	4	5412 ESBU Buttable Hinge (Cover Part)
1	STK-Q-45729-22	2	6500 MXD - Lock Door Top Closing Bar
1	886PHD-S	4	Euroform Pull Handle Kit
8	STK-Q-16055	1	M6 x 18mm Stud (No Paint Cap Required)
1	6500MXK220808DS1	5	6500 MX 2200mm x 800mm Door Stiffener
1	6500MXK220808FG	1	6500 MXD 2200mm x 800mm Front Gasket
1	6500MXK220808F-P	1	6500 MXD 2200mm x 800mm Front Part
4	STK-K-06811	1	6500 MX - Hinge Assy
Qty	Part Number	Rev	Description
Parts List			

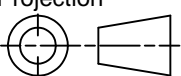
 Tél: (450) 979-4373 Fax: (450) 979-4626 www.exmweb.com		Flatness Aplatissement Max 3.0mm Projection 
Customer Client	Date	Date
Drawn By Dessiné Par	BoxCad: Annie	Date 25/02/2015
Material Matière	14 Ga H.R.P. & O. (1.7mm)	
Color Couleur	Light Grey RAL7035	Finish Fini Rough Textured
Description	Detail Rev.	
6500 MXD 2200mm x 800mm Front		
Part Number Numéro Pièce	Rev.	3
6500MXK220808F	1	3

This drawing is confidential and must not be reproduced or used without the consent of EXM

Ce dessin est confidentiel et ne doit pas être reproduit ou utilisé sans le consentement de EXM

No.	Revisions	Date	By/Par
1		11/03/2015	

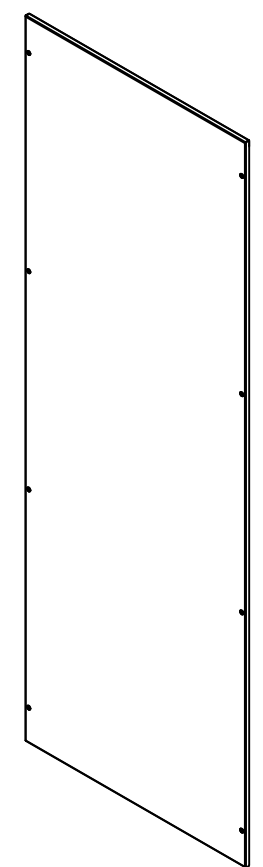

Isometric View

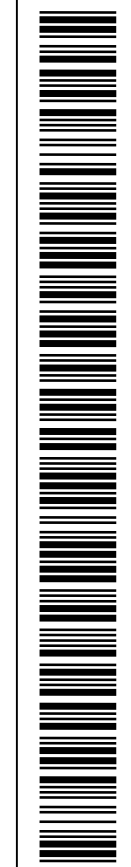

		Flatness Aplatissement Max 3.0mm Projection	
Tél: (450) 979-4373 Fax: (450) 979-4626 www.exmweb.com		Customer Client Date	
Drawn By Dessiné Par: BoxCad: Annie		Date: 25/02/2015	
Material Matière: 16 Ga H.R.P. & O. (1.4mm)		Color Couleur: Light Grey RAL7035	
Description 6500 MXC 2200mm x 800mm Left		Finish Fini: Rough Textured	
Part Number Numéro Pièce: 6500MXK220808L		Detail Rev. Rev. 1 / 3	

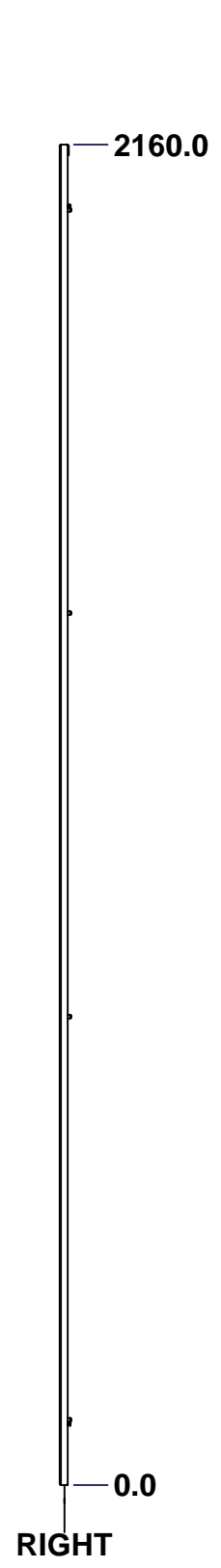
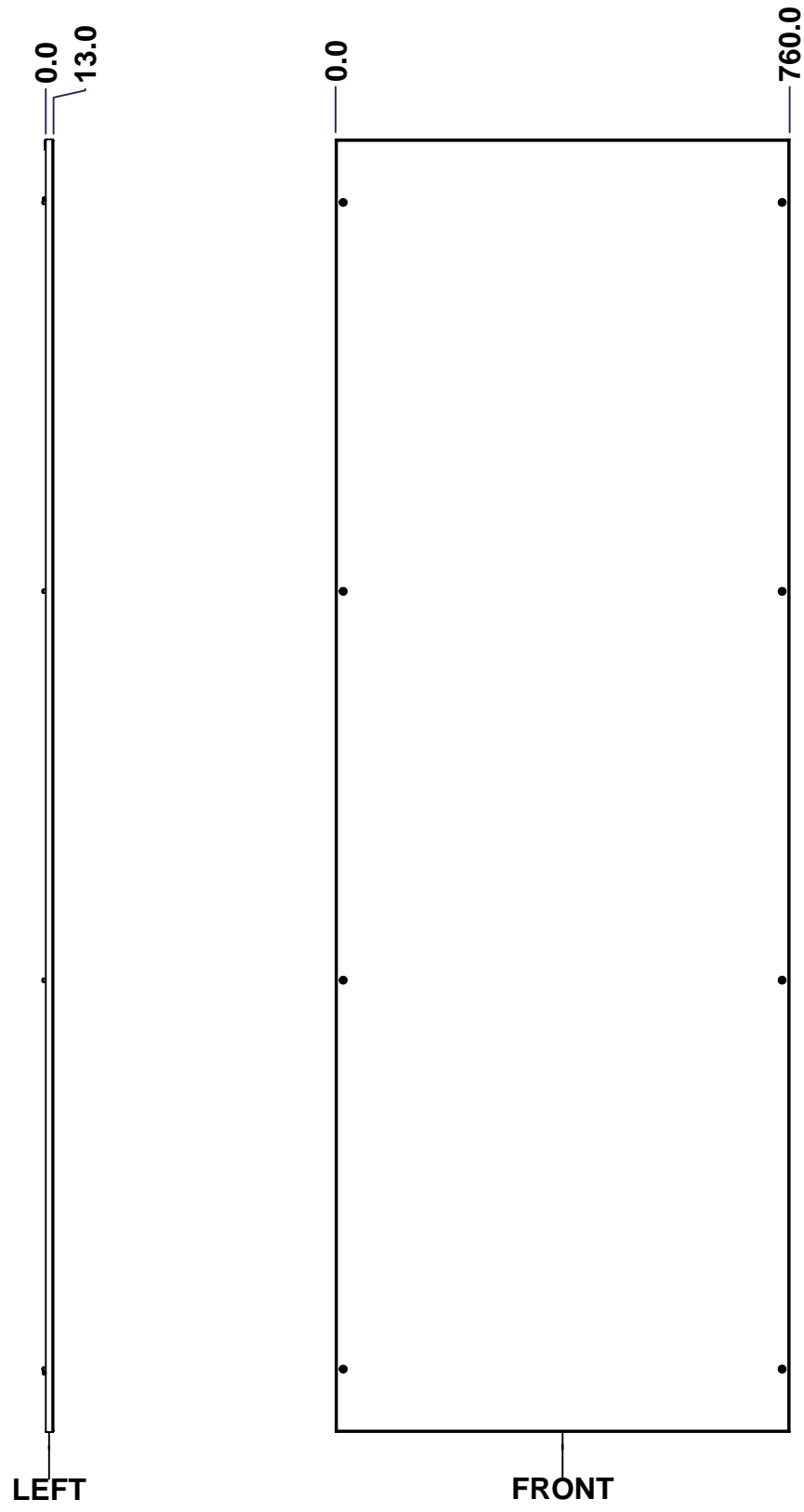
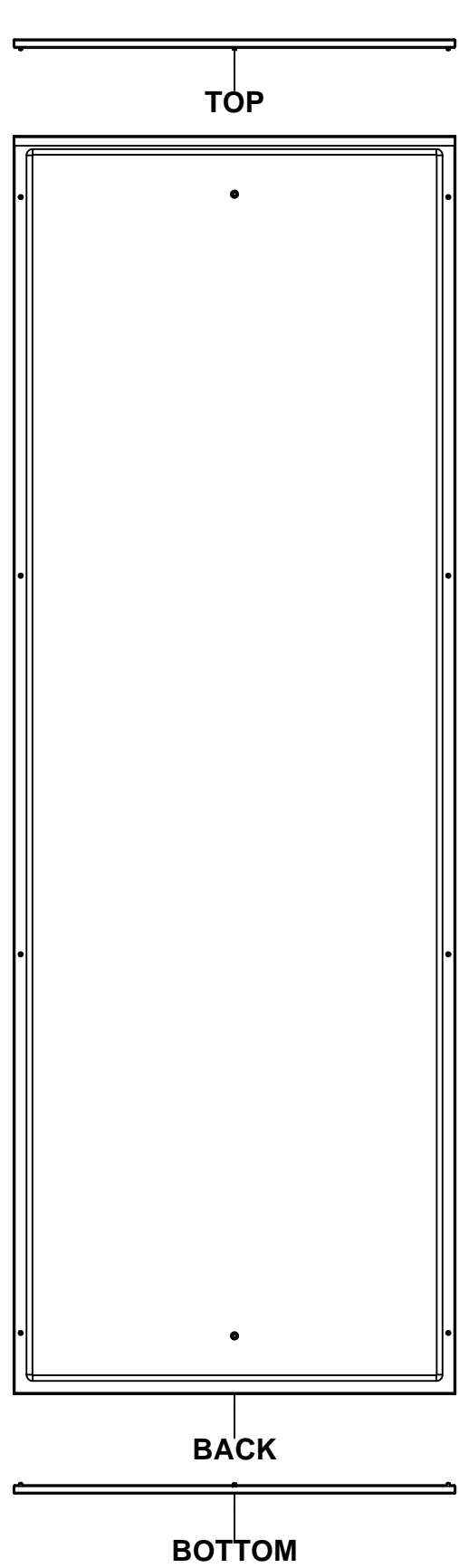

SEE BILL OF MATERIAL ON LAST PAGE

This drawing is confidential and must not be reproduced or used without the consent of EXM

Ce dessin est confidentiel et ne doit pas être reproduit ou utilisé sans le consentement de EXM

STANDARD FEATURES ARE NOT LISTED IN THIS HOLE TABLE			
HOLE TABLE - FRONT VIEW (CUSTOM FEATURE ONLY)			
CUT-OUT	XDIM	YDIM	DESCRIPTION
1	380.0	100.0	GND STUD M6 x 16mm (Inside)
2	380.0	2060.0	GND STUD M6 x 16mm (Inside)

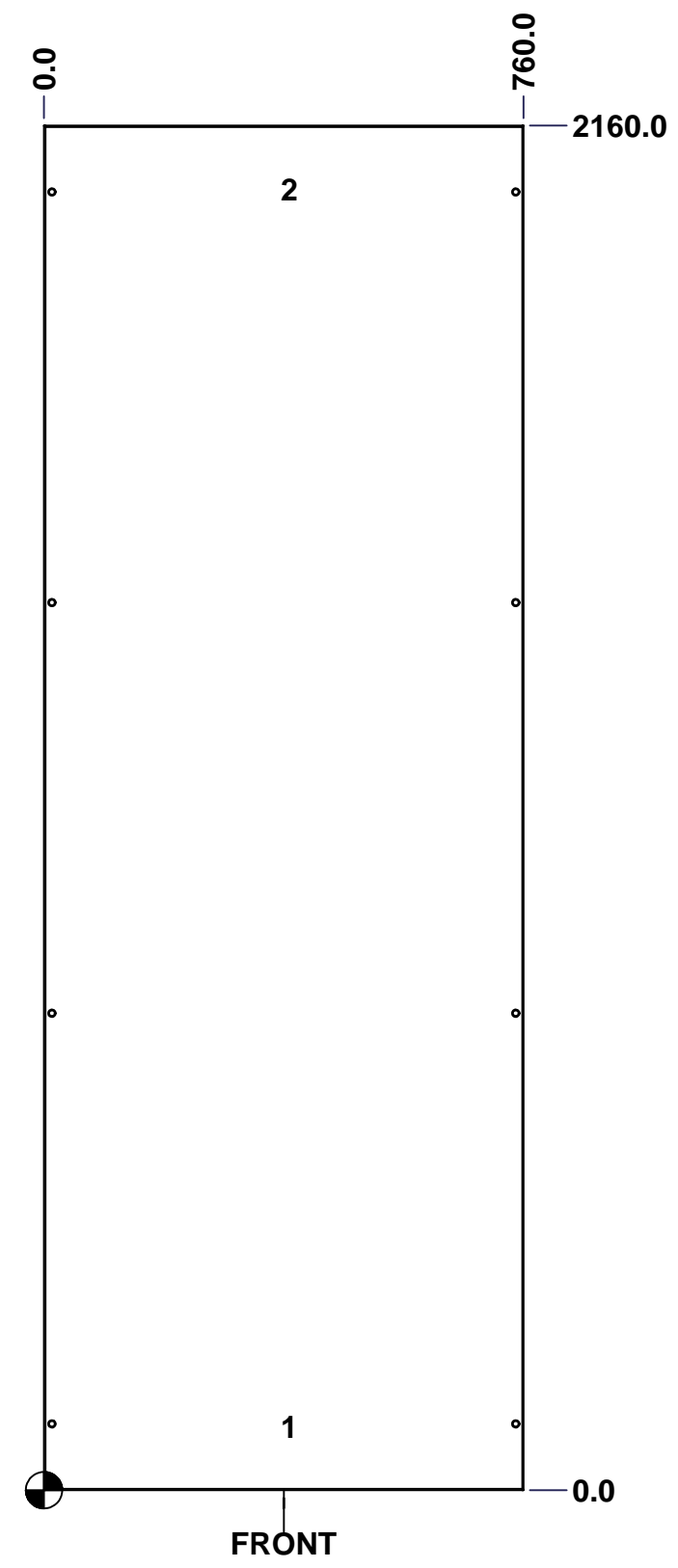



	Description	Status	
	6500 MXC 2200mm x 800mm Left	(NULL)	
	Part Number Numéro Pièce	Rev.	
	6500MXK220808L	1	2 3

This drawing is confidential and must not be reproduced or used without the consent of EXM

Ce dessin est confidentiel et ne doit pas être reproduit ou utilisé sans le consentement de EXM

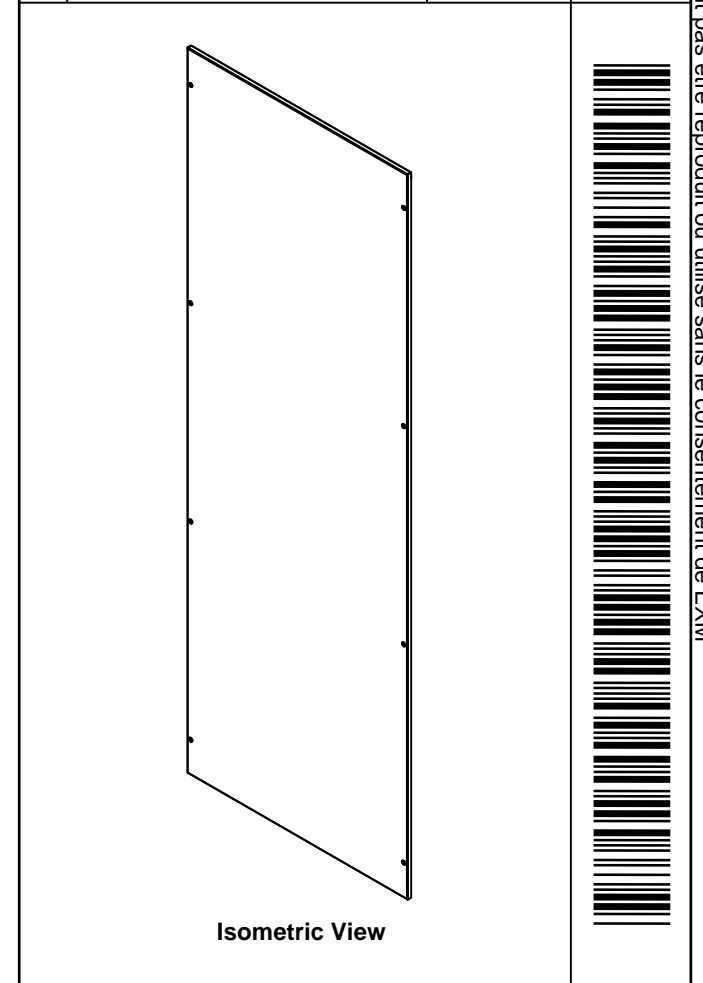
No.	Revisions	Date	By/Par
1		11/03/2015	

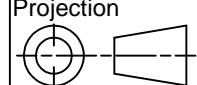

 Tél: (450) 979-4373 Fax: (450) 979-4626 www.exmweb.com		Flatness Aplatissement Max 3.0mm Projection 
Customer Client	Date	
Drawn By Dessiné Par	BoxCad: Annie	Date 25/02/2015
Material Matière 16 Ga H.R.P. & O. (1.4mm)		
Color Couleur	Light Grey RAL7035	Finish Fini Rough Textured
Description 6500 MXC 2200mm x 800mm Left		Detail Rev.
Part Number Numéro Pièce 6500MXK220808L		Rev. 3 1 3

Qty	Part Number	Rev	Description
1	STK-P-03820R	0	Powder Paint (Light Grey / Rough Textured)
8	STK-Q-03072	2	M6 x 17mm Phillips Flat Head Screw
2	STK-Q-16080	0.1.1	M6 x 16mm Ground Stud
1	6500MXK220808LG	1	6500 MXC 2200mm x 800mm Left Gasket
1	6500MXK220808L-P	1	6500 MXC 2200mm x 800mm Left Part
Parts List			

This drawing is confidential and must not be reproduced or used without the consent of EXM

Ce dessin est confidentiel et ne doit pas être reproduit ou utilisé sans le consentement de EXM

No.	Revisions	Date	By/Par
1		11/03/2015	

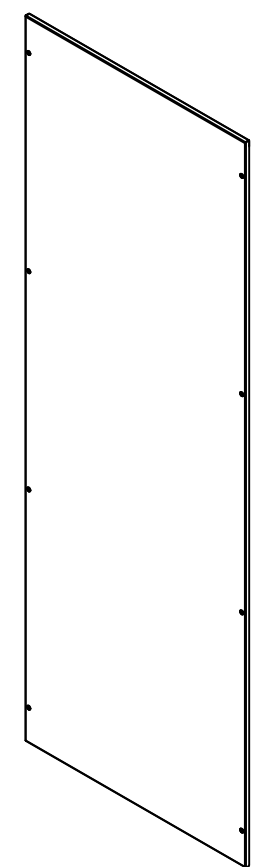

Isometric View

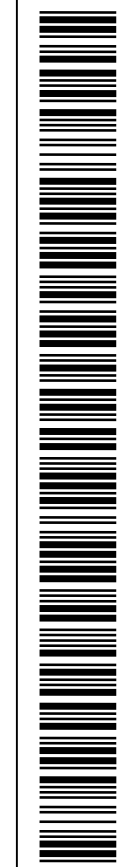

		Flatness Aplatissement Max 3.0mm Projection	
Tél: (450) 979-4373 Fax: (450) 979-4626 www.exmweb.com		Customer Client Date	
Drawn By Dessiné Par BoxCad: Annie		Date 25/02/2015	
Material Matière 16 Ga H.R.P. & O. (1.4mm)		Color Couleur Light Grey RAL7035	
Description 6500 MXC 2200mm x 800mm Right		Finish Fini Rough Textured	
Part Number Numéro Pièce 6500MXK220808R		Detail Rev. Rev. 1 3	

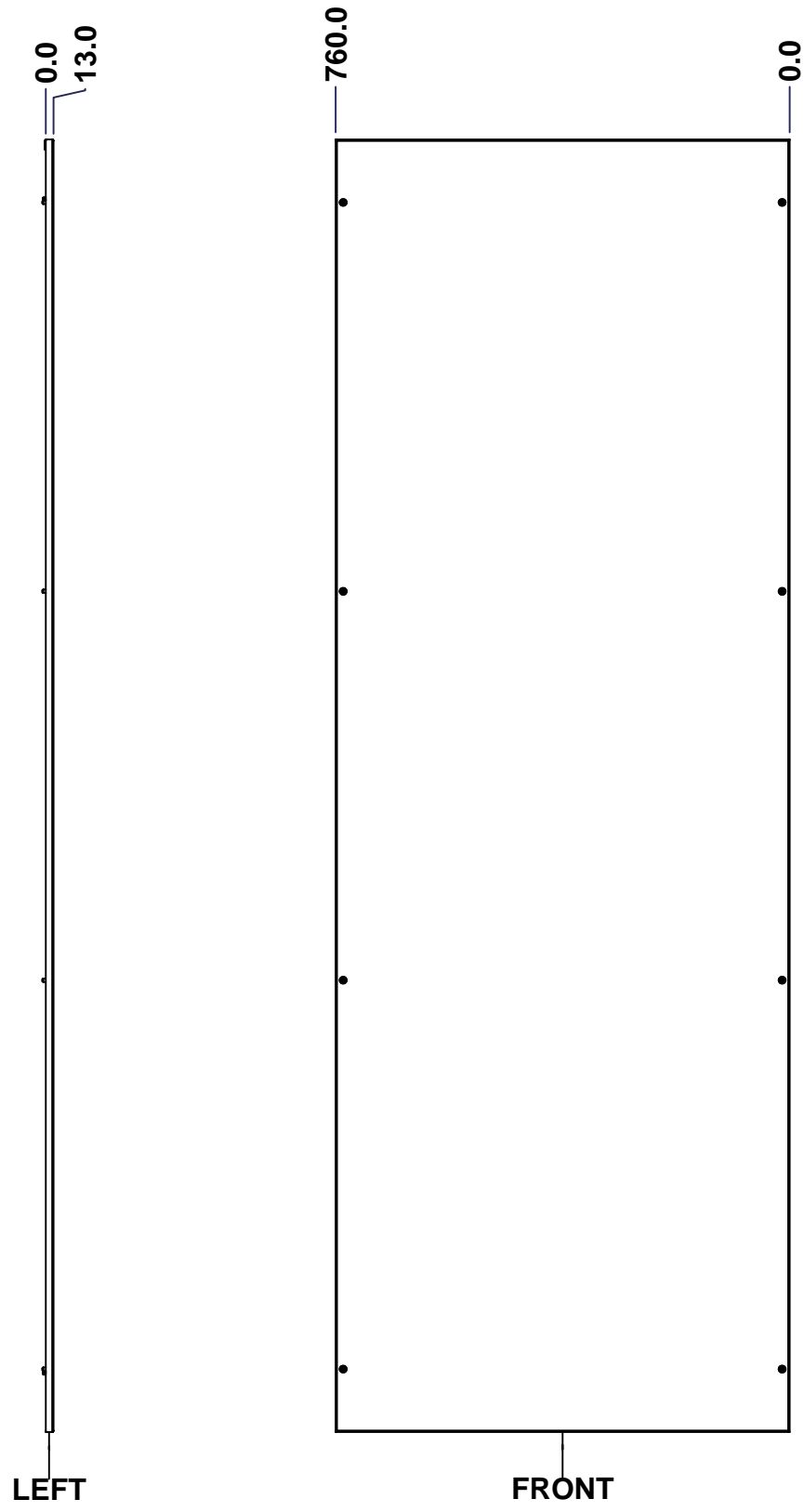
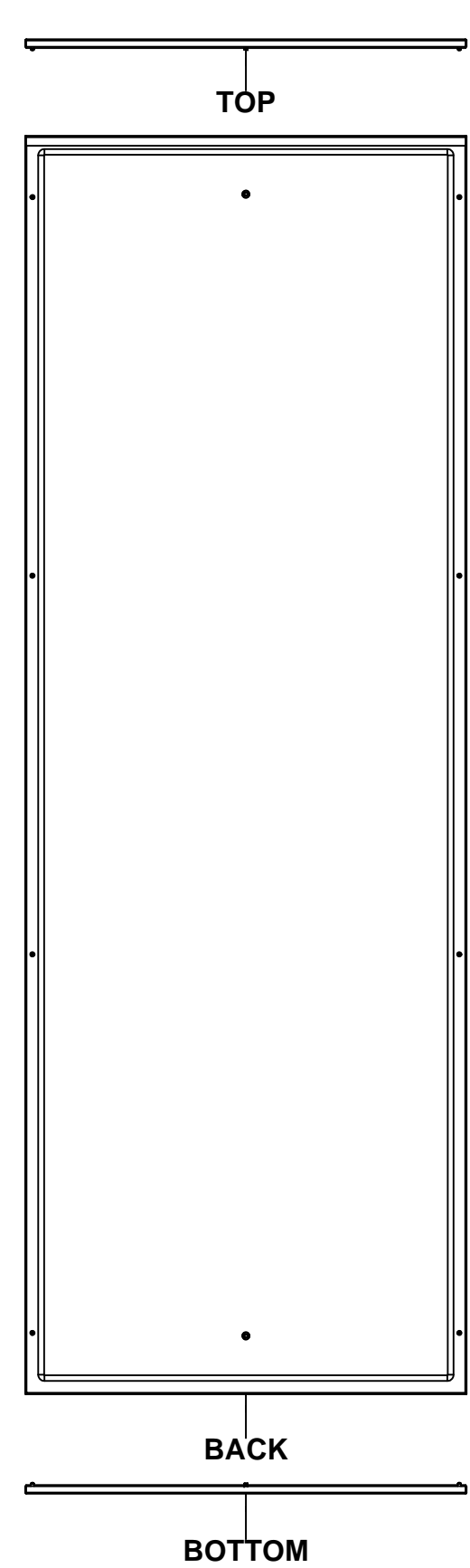

SEE BILL OF MATERIAL ON LAST PAGE

This drawing is confidential and must not be reproduced or used without the consent of EXM

Ce dessin est confidentiel et ne doit pas être reproduit ou utilisé sans le consentement de EXM

STANDARD FEATURES ARE NOT LISTED IN THIS HOLE TABLE			
HOLE TABLE - FRONT VIEW (CUSTOM FEATURE ONLY)			
CUT-OUT	XDIM	YDIM	DESCRIPTION
1	380.0	100.0	GND STUD M6 x 16mm (Inside)
2	380.0	2060.0	GND STUD M6 x 16mm (Inside)

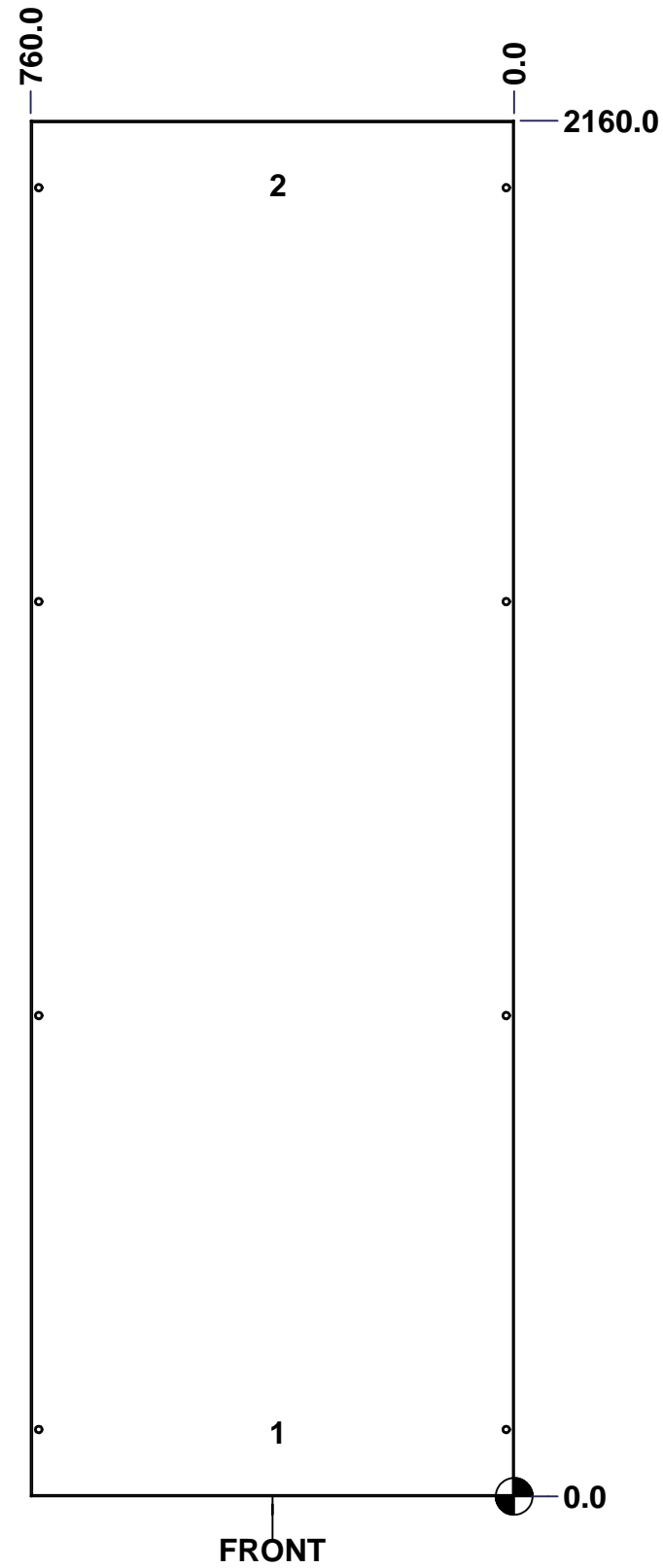

	Description 6500 MXC 2200mm x 800mm Right	Status (NULL)
	Part Number Numéro Pièce 6500MXK220808R	Rev. 1

2	3
1	

This drawing is confidential and must not be reproduced or used without the consent of EXM

Ce dessin est confidentiel et ne doit pas être reproduit ou utilisé sans le consentement de EXM

No.	Revisions	Date	By/Par
1		11/03/2015	

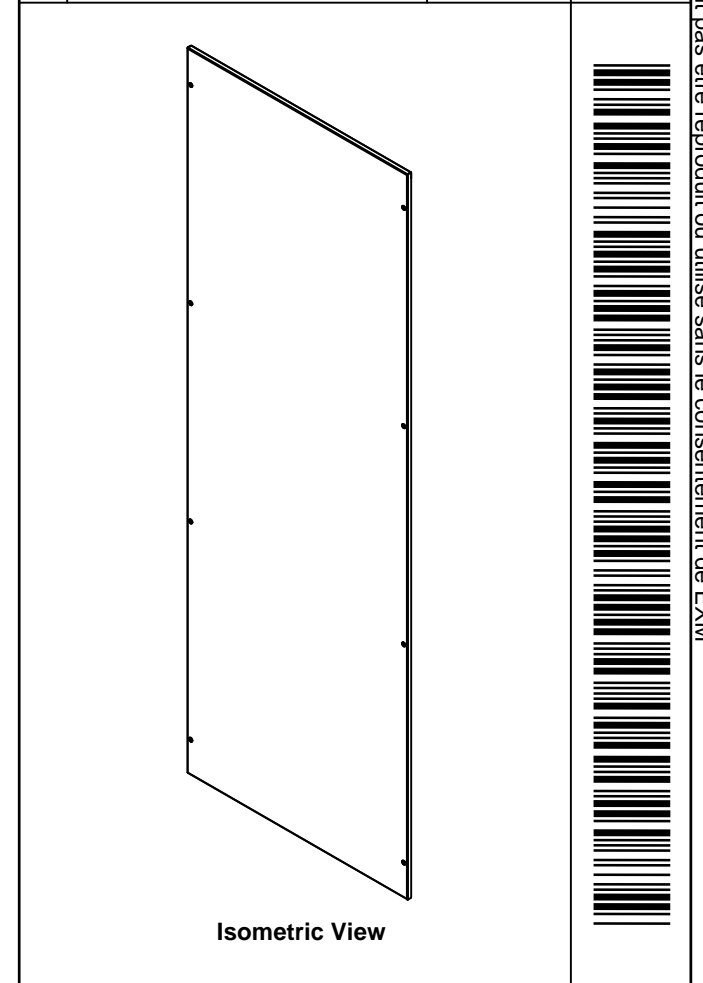

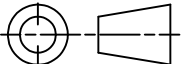
 Tél: (450) 979-4373 Fax: (450) 979-4626 www.exmweb.com		Flatness Aplatissement Max 3.0mm Projection 
Customer Client	Date	
Drawn By Dessiné Par	BoxCad: Annie	Date 25/02/2015
Material Matière	16 Ga H.R.P. & O. (1.4mm)	
Color Couleur	Light Grey RAL7035	Finish Fini Rough Textured
Description	6500 MXC 2200mm x 800mm Right	Detail Rev.
Part Number Numéro Pièce	6500MXK220808R	Rev. 3
		1 / 3

Qty	Part Number	Rev	Description
1	STK-P-03820R	0	Powder Paint (Light Grey / Rough Textured)
8	STK-Q-03072	2	M6 x 17mm Phillips Flat Head Screw
2	STK-Q-16080	0.1.1	M6 x 16mm Ground Stud
1	6500MXK220808RG	1	6500 MXC 2200mm x 800mm Right Gasket
1	6500MXK220808R-P	1	6500 MXC 2200mm x 800mm Right Part
Parts List			

This drawing is confidential and must not be reproduced or used without the consent of EXM

Ce dessin est confidentiel et ne doit pas être reproduit ou utilisé sans le consentement de EXM

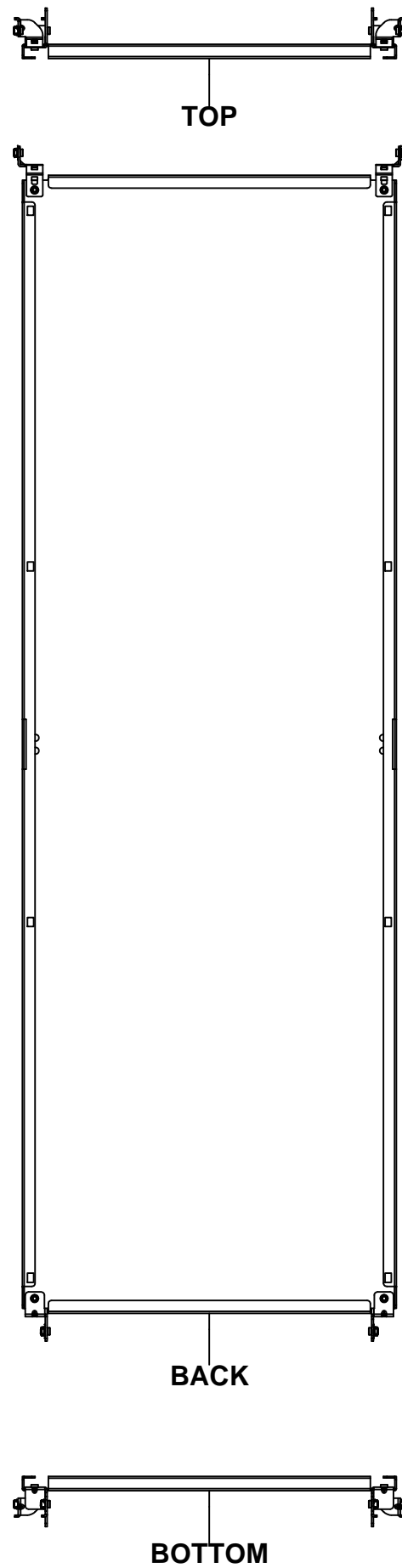

No.	Revisions	Date	By/Par
1		11/03/2015	

Isometric View

		Tél: (450) 979-4373 Fax: (450) 979-4626 www.exmweb.com		Flatness Aplatissement Max 3.0mm Projection 	
Customer Client		Date		Date 25/02/2015	
Drawn By Dessiné Par BoxCad: Annie		Material Matière 12 Ga Galvanized (2.5mm)		Color Couleur Unpainted	
				Finish Fini Unpainted	
Description 6500 MXM 2200mm x 800mm Back Inner Panel				Detail Rev.	
Part Number Numéro Pièce 6500MXK220808BIP				Rev. 1	
				3	

SEE BILL OF MATERIAL ON LAST PAGE

This drawing is confidential and must not be reproduced or used without the consent of EXM

Ce dessin est confidentiel et ne doit pas être reproduit ou utilisé sans le consentement de EXM

No.	Revisions	Date	By/Par
1		11/03/2015	

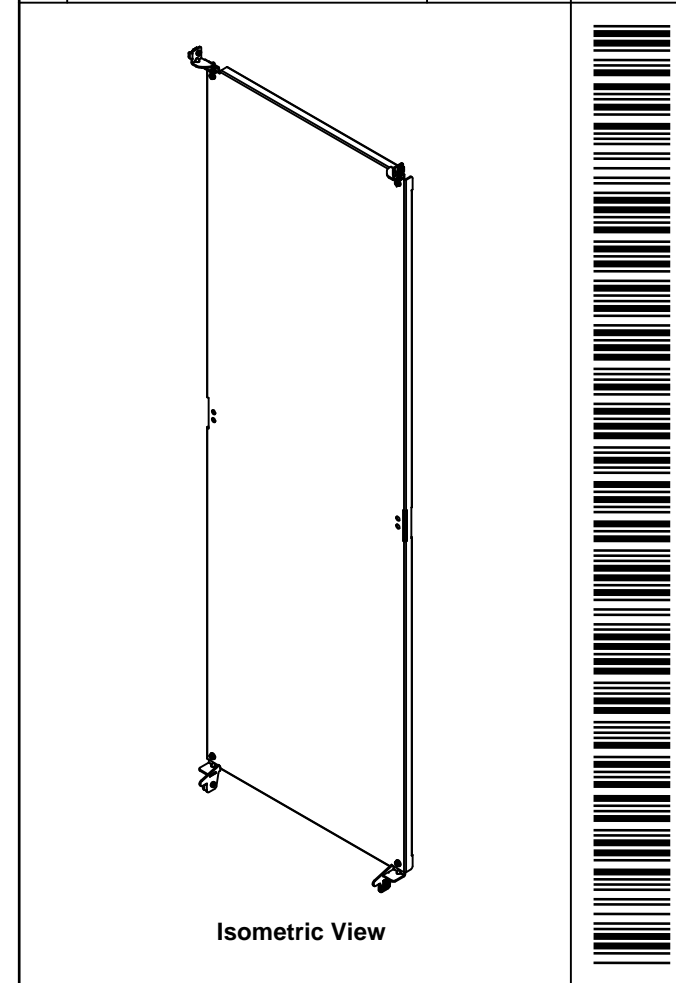

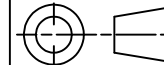
 Tél: (450) 979-4373 Fax: (450) 979-4626 www.exmweb.com		Flatness Aplatissement Max 3.0mm Projection 
Customer Client	Date	
Drawn By Dessiné Par	BoxCad: Annie	Date 25/02/2015
Material Matière	12 Ga Galvanized (2.5mm)	
Color Couleur	Unpainted	Finish Fini Unpainted
Description 6500 MXM 2200mm x 800mm Back Inner Panel		Detail Rev.
Part Number Numéro Pièce	6500MXK220808BIP	Rev. 3
		1 / 3

Qty	Part Number	Rev	Description
1	STK-A-49005	0	6500MXM - Bottom Inner Panel Support Kit (Right)
1	STK-A-49000	0	6500MXM - Bottom Inner Panel Support Kit (Left)
1	STK-A-49015	0	6500MXM - Top Inner Panel Support Kit (Right)
1	STK-A-49010	0	6500MXM - Top Inner Panel Support Kit (Left)
1	6500MXK220808BIP-P	1	6500 MXM 2200mm x 800mm Back Inner Panel Part
Parts List			