

This drawing is confidential and must not be reproduced or used without the consent of EXM

Ce dessin est confidentiel et ne doit pas être reproduit ou utilisé sans le consentement de EXM

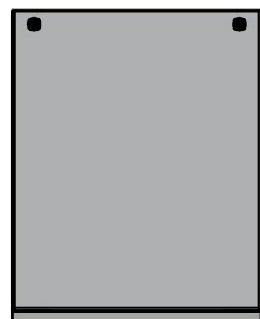

TOP



BACK

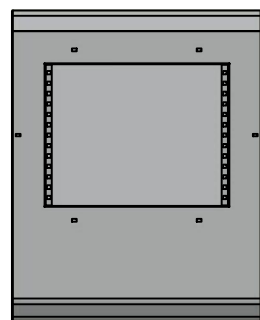

BOTTOM

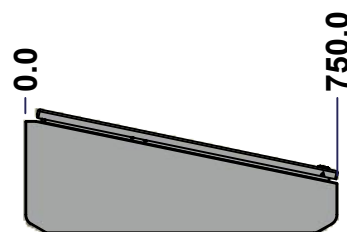

LEFT

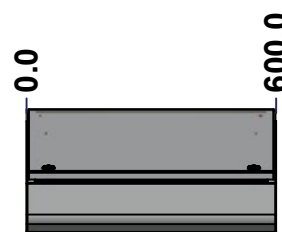

FRONT

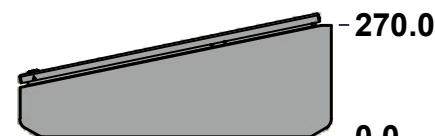

RIGHT

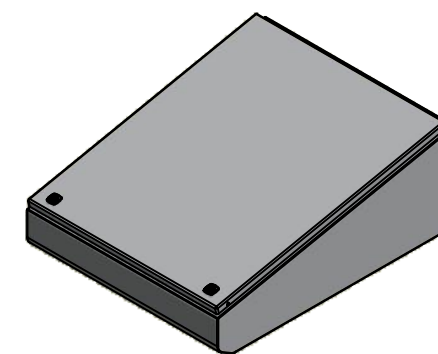

Isometric View

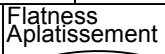
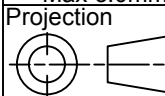

| No. | Revisions | Date | By/Par |
|-----|-----------|------|--------|
| | | | |
| | | | |
| | | | |
| | | | |

| | | |
|--|-------------------------------|---|
|  Tél: (450) 979-4373 Fax: (450) 979-4626 www.exmweb.com | | Flatness Aplatissement  Max 3.0mm |
| Customer Client | | Projection  |
| Drawn By Dessiné Par BoxCad: BoxCad | | Date 22-Jul-22 |
| Material Matière 16 Ga Cold Rolled A1008 CS Type B (1.4mm) | | |
| Color Couleur Light Grey RAL7035 | Finish Fini Rough Textured | |
| Description 6500WD 120mm x 600mm x 500mm Assembly | | Detail Rev. |
| Part Number Numéro Pièce 6500WD0605 | | Rev. 1 0 / 9 |

SEE BILL OF MATERIAL ON LAST PAGE

This drawing is confidential and must not be reproduced or used without the consent of EXM

Ce dessin est confidentiel et ne doit pas être reproduit ou utilisé sans le consentement de EXM

| NOTE | |
|------|--|
| ITEM | DESCRIPTION |
| 1 | NEMA 12/13 Enclosure |
| 2 | C/W Standard ground studs on box and cover |
| 3 | C/W Standard door stiffener |
| 4 | W/O Inner panel |
| 5 | C/W Standard inner panel mounting studs |

| No. | Revisions | Date | By/Par |
|-----|-----------|------|--------|
| | | | |
| | | | |
| | | | |
| | | | |
| | | | |
| | | | |

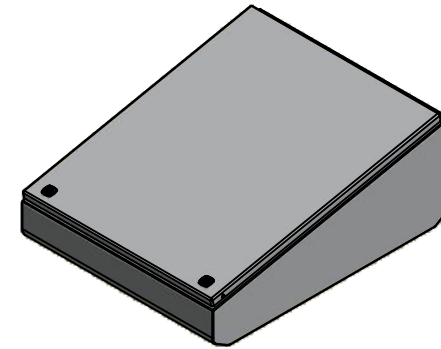

Isometric View

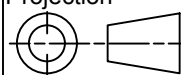
| | |
|--|---|
|  Tél: (450) 979-4373 Fax: (450) 979-4626 www.exmweb.com | Flatness Aplatissement Max 3.0mm |
| | Projection  |
| Customer Client | Date |
| Drawn By Dessiné Par BoxCad: BoxCad | Date 22-Jul-22 |
| Material Matière 16 Ga Cold Rolled A1008 CS Type B (1.4mm) | |

| PACKING | | |
|----------------------|-----|--|
| ITEM | QTY | DESCRIPTION |
| Cardboard corner | 2 | To reinforced for the plastic strap tightening |
| Honeycomb angle | 4 | To protect each corners |
| Plastic strap- Green | 2 | To secure the enclosure to the wood pallet |
| Wood pallet | 1 | Standard wood pallet |
| Flat cardboard | 1 | Between the enclosure and the wood pallet |
| Packaging label | 1 | White label with product number |

| Qty | Part Number | Rev | Description |
|------------|----------------|-----|--|
| 8 | STK-Q-05025 | 1 | M5 x 9.5mm Thread Rolling Screw |
| 2 | 880 GS115 | 0 | Gas Spring 115N/12Kg/26Lbs |
| 1 | 6500WD0605TD | 0 | 6500WD 600mm x 500mm Top Cover |
| 1 | 6500WD0605B | 0 | 6500WD 120mm x 600mm x 500mm Body |
| 2 | STK-Q-04050-07 | 7 | M6 x 7mm Hexagon Socket Head Machine Screw with Nyseal |
| 4 | STK-Q-08100 | 1 | M5 Nylon Insert Lock Nut |
| Parts List | | | |

| | |
|--|-------------------------------|
| Color Couleur Light Grey RAL7035 | Finish Fini Rough Textured |
| Description 6500WD 120mm x 600mm x 500mm Assembly | |
| Part Number Numéro Pièce 6500WD0605 | Rev. 2 0 / 9 |

This drawing is confidential and must not be reproduced or used without the consent of EXM

Ce dessin est confidentiel et ne doit pas être reproduit ou utilisé sans le consentement de EXM

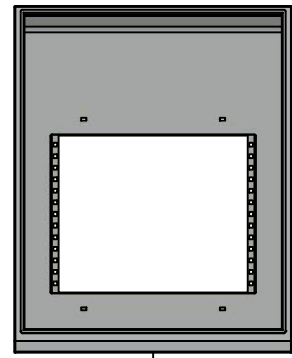

TOP



BACK

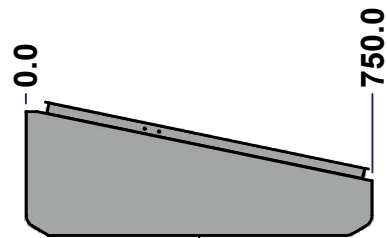

LEFT



FRONT

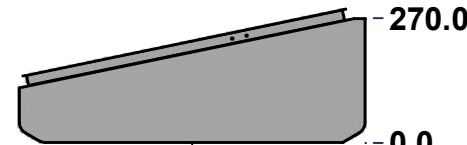

RIGHT

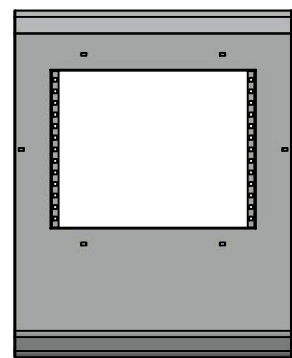

BOTTOM

| No. | Revisions | Date | By/Par |
|-----|-----------|------|--------|
| | | | |
| | | | |
| | | | |
| | | | |
| | | | |

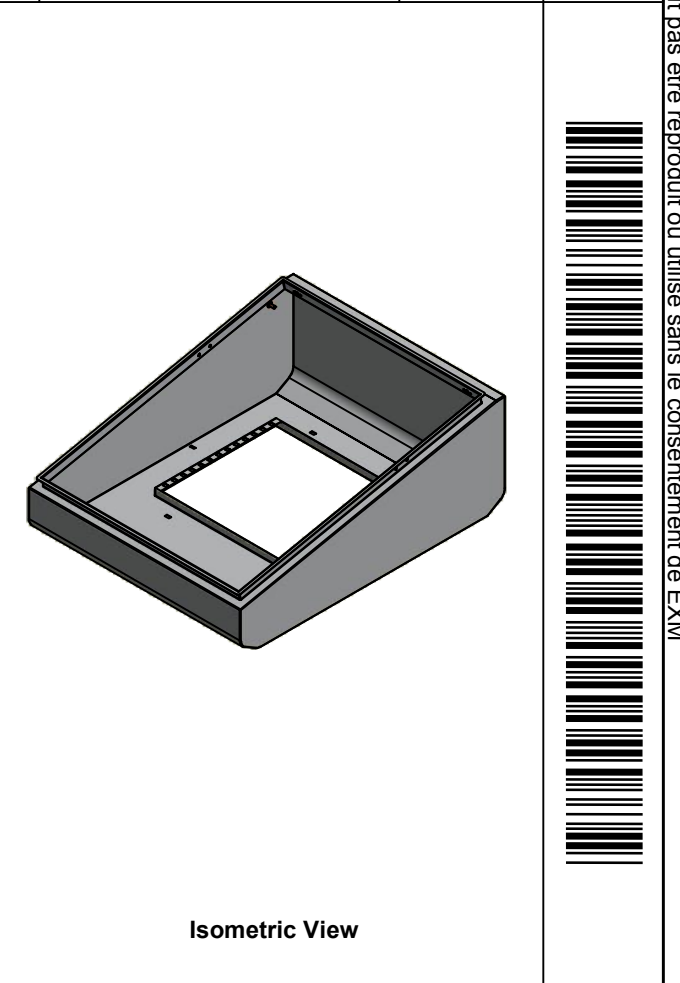

Isometric View



Tél: (450) 979-4373
 Fax: (450) 979-4626
www.exmweb.com

Flatness
Aplatissement

Max 3.0mm

Projection



| | |
|---|-------------------------------|
| Customer Client | Date |
| Drawn By Dessiné Par BoxCad: BoxCad | Date 22-Jul-22 |
| Material Matière 16 Ga Cold Rolled A1008 CS Type B (1.4mm) | |
| Color Couleur Light Grey RAL7035 | Finish Fini Rough Textured |
| Description 6500WD 120mm x 600mm x 500mm Body | Detail Rev. |
| Part Number Numéro Pièce 6500WD0605B | Rev. 3 0 / 9 |

SEE BILL OF MATERIAL ON LAST PAGE

This drawing is confidential and must not be reproduced or used without the consent of EXM

Ce dessin est confidentiel et ne doit pas être reproduit ou utilisé sans le consentement de EXM

| STANDARD FEATURES ARE NOT LISTED IN THIS HOLE TABLE | | | |
|--|------|-------|-----------------------------|
| HOLE TABLE - RIGHT VIEW (CUSTOM FEATURE ONLY) | | | |
| CUT-OUT | XDIM | YDIM | DESCRIPTION |
| 1 | 70.0 | 230.0 | GND STUD M6 x 16mm (Inside) |

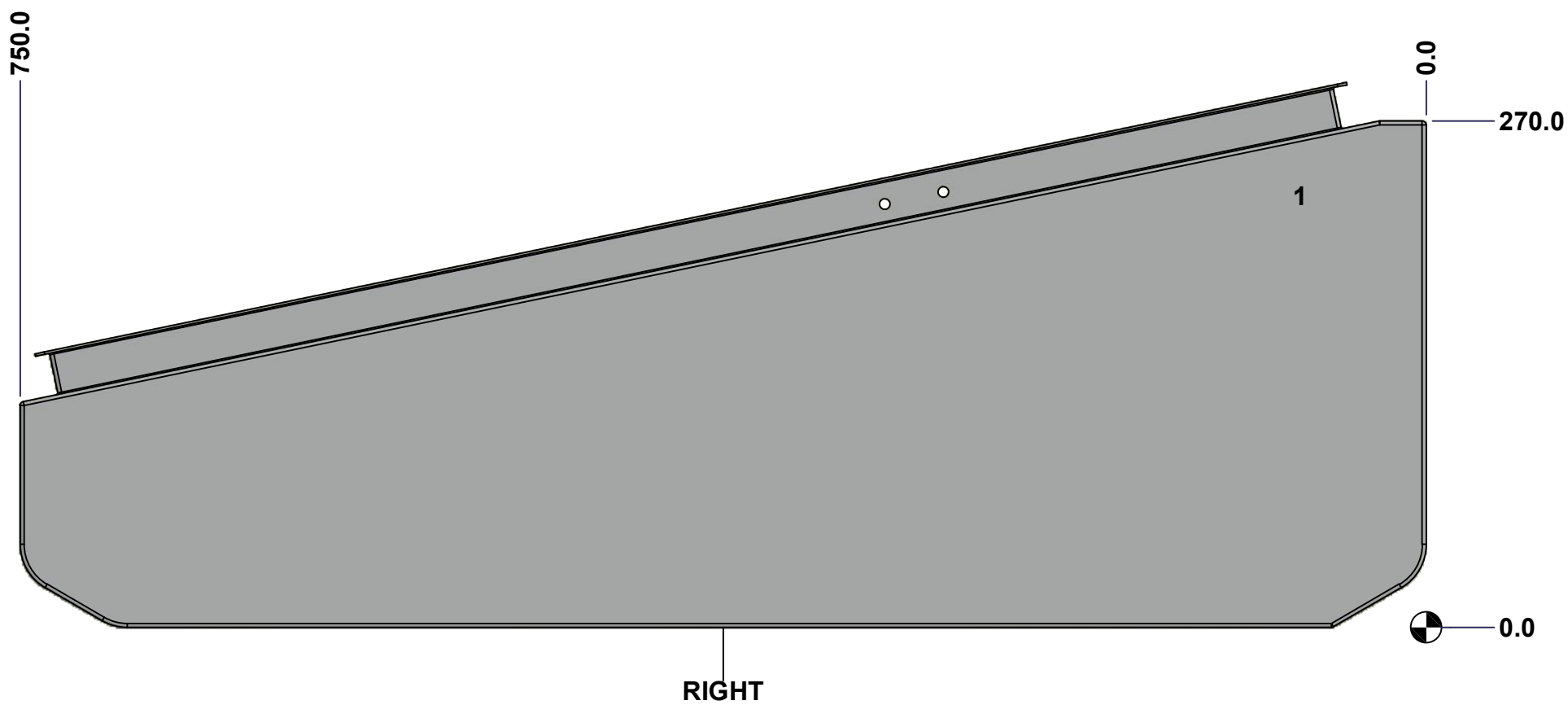

| | | |
|--|---|------------------------|
| | Description 6500WD 120mm x 600mm x 500mm Body | Status (NULL) |
| | Part Number Numéro Pièce 6500WD0605B | Rev. 4 0 / 9 |

This drawing is confidential and must not be reproduced or used without the consent of EXM

Ce dessin est confidentiel et ne doit pas être reproduit ou utilisé sans le consentement de EXM

| STANDARD FEATURES ARE NOT LISTED IN THIS HOLE TABLE | | | |
|--|------|-------|-----------------------------|
| HOLE TABLE - LEFT VIEW (CUSTOM FEATURE ONLY) | | | |
| CUT-OUT | XDIM | YDIM | DESCRIPTION |
| 1 | 70.0 | 230.0 | GND STUD M6 x 16mm (Inside) |

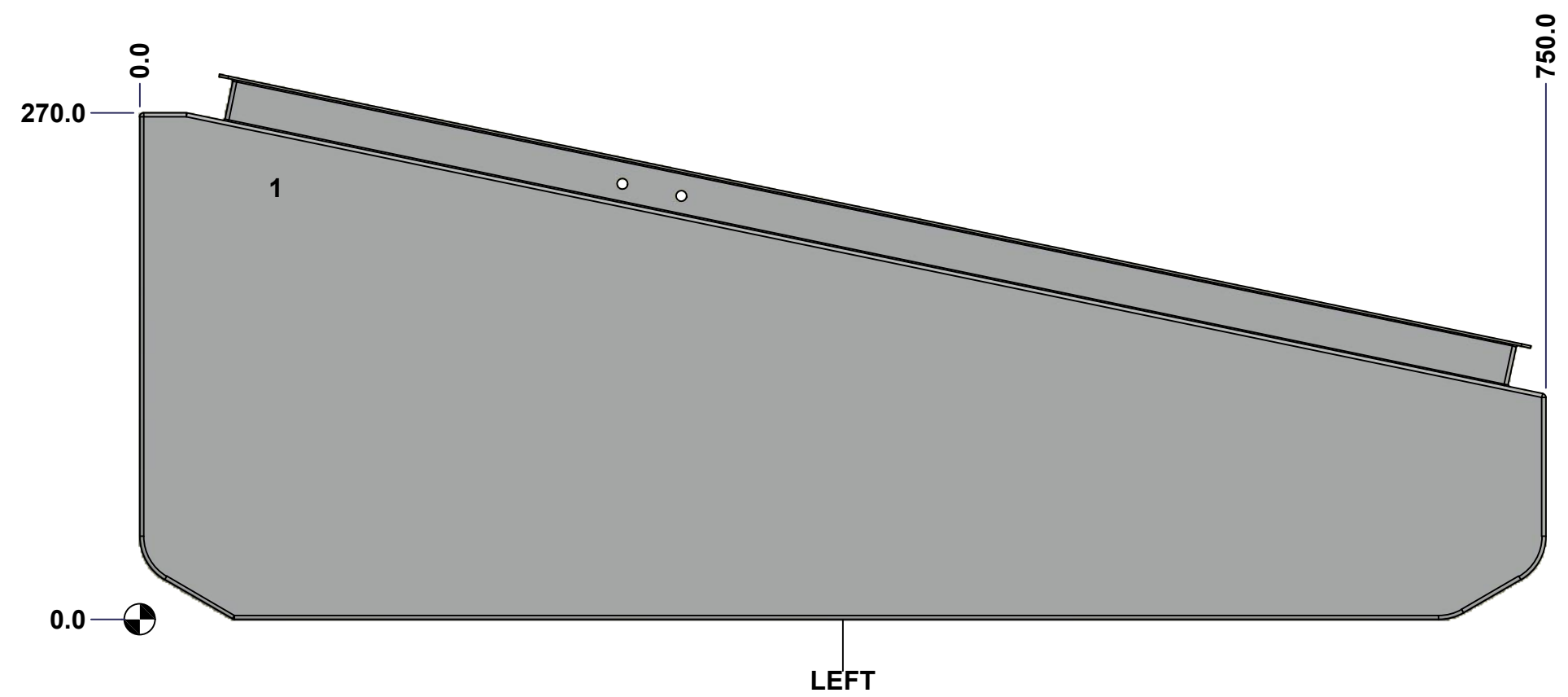

| | | |
|--|---|------------------------|
| | Description 6500WD 120mm x 600mm x 500mm Body | Status (NULL) |
| | Part Number Numéro Pièce 6500WD0605B | Rev. 5 0 / 9 |

This drawing is confidential and must not be reproduced or used without the consent of EXM

Ce dessin est confidentiel et ne doit pas être reproduit ou utilisé sans le consentement de EXM

| No. | Revisions | Date | By/Par |
|-----|-----------|------|--------|
| | | | |
| | | | |
| | | | |
| | | | |
| | | | |

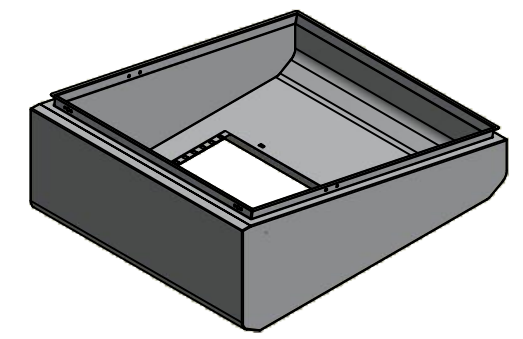

Isometric View

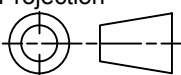
| | | |
|--|---|---|
|  Tél: (450) 979-4373 Fax: (450) 979-4626 www.exmweb.com | Flatness Aplatissement | Max 3.0mm |
| | Projection |  |
| Customer Client | Date | |
| Drawn By Dessiné Par | BoxCad: BoxCad | Date 22-Jul-22 |
| Material Matière | 16 Ga Cold Rolled A1008 CS Type B (1.4mm) | |
| Color Couleur | Light Grey RAL7035 | Finish Fini Rough Textured |
| Description | Detail Rev. | |
| 6500WD 120mm x 600mm x 500mm Body | | |
| Part Number Numéro Pièce | Rev. | 6 |
| 6500WD0605B | 0 | 9 |

| Qty | Part Number | Rev | Description |
|------------|---------------|-----|--|
| 2 | STK-Q-16080 | 0 | Ground Stud M6 x 16mm |
| 1 | STK-P-03820R | 0 | Powder Paint (Light Grey / Rough Textured) |
| 1 | 6500WD0605B-P | 0 | 6500WD 120mm x 600mm x 500mm Body Part |
| Parts List | | | |

This drawing is confidential and must not be reproduced or used without the consent of EXM

Ce dessin est confidentiel et ne doit pas être reproduit ou utilisé sans le consentement de EXM



TOP



BACK

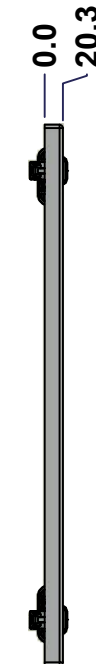

LEFT

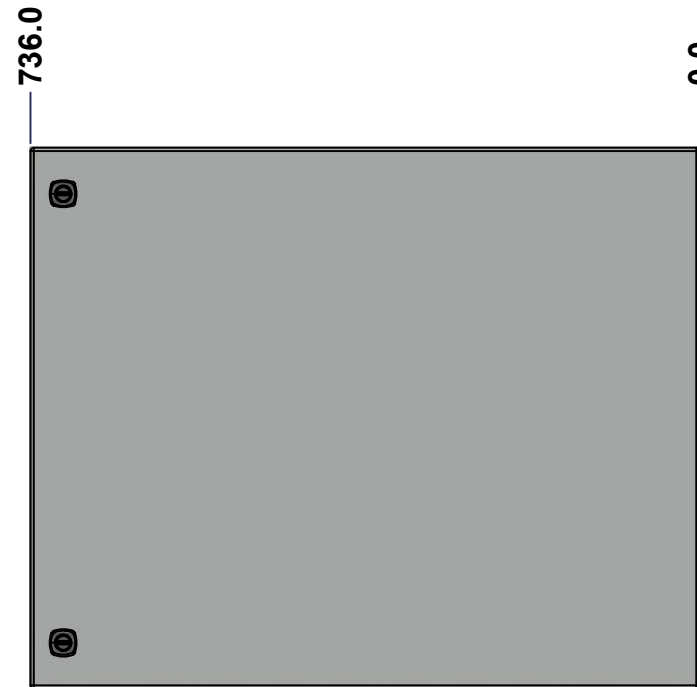

FRONT

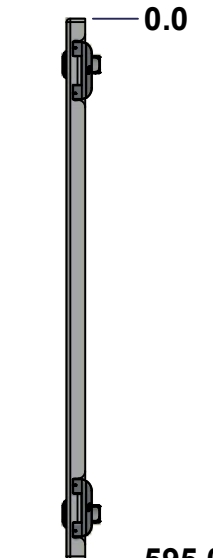

RIGHT



BOTTOM

| No. | Revisions | Date | By/Par |
|-----|-----------|------|--------|
| | | | |
| | | | |
| | | | |
| | | | |

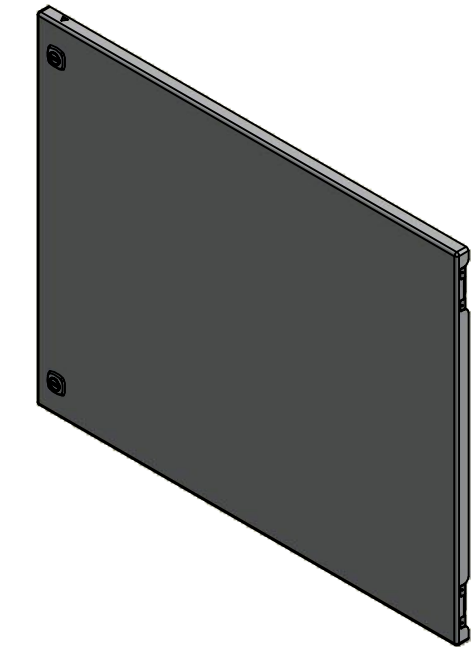

Isometric View



Tél: (450) 979-4373
 Fax: (450) 979-4626
www.exmweb.com

Flatness
Aplatissement

Max 3.0mm

Projection

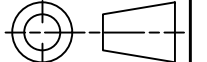

| | |
|---|-----------------|
| Customer Client | Date |
| Drawn By / Dessiné Par: BoxCad: BoxCad | Date: 22-Jul-22 |
| Material / Matière: 14 Ga Cold Rolled A1008 CS Type B (1.7mm) | |

| | |
|-------------------------------------|-------------------------------|
| Color / Couleur: Light Grey RAL7035 | Finish / Fini: Rough Textured |
|-------------------------------------|-------------------------------|

| | |
|---|-------------|
| Description: 6500WD 600mm x 500mm Top Cover | Detail Rev. |
|---|-------------|

| | | | |
|---|--------|---|---|
| Part Number / Numéro Pièce: 6500WD0605TD | Rev. 0 | 7 | 9 |
|---|--------|---|---|

SEE BILL OF MATERIAL ON LAST PAGE

This drawing is confidential and must not be reproduced or used without the consent of EXM

Ce dessin est confidentiel et ne doit pas être reproduit ou utilisé sans le consentement de EXM

STANDARD FEATURES ARE NOT LISTED IN THIS HOLE TABLE

HOLE TABLE - FRONT VIEW (CUSTOM FEATURE ONLY)

| CUT-OUT | XDIM | YDIM | DESCRIPTION |
|---------|-------|-------|-----------------------------|
| 1 | 58.6 | 50.0 | STUD M6 x 18mm (Inside) |
| 2 | 283.6 | 50.0 | STUD M6 x 18mm (Inside) |
| 3 | 58.6 | 545.0 | STUD M6 x 18mm (Inside) |
| 4 | 283.6 | 545.0 | STUD M6 x 18mm (Inside) |
| ----- | | | |
| 5 | 70.0 | 560.0 | GND STUD M6 x 16mm (Inside) |
| 6 | 70.0 | 35.0 | GND STUD M6 x 16mm (Inside) |
| 7 | 699.8 | 50.8 | LOCK 880 SCQ4-SL @ 270.0° |
| 8 | 699.8 | 544.2 | LOCK 880 SCQ4-SL @ 270.0° |

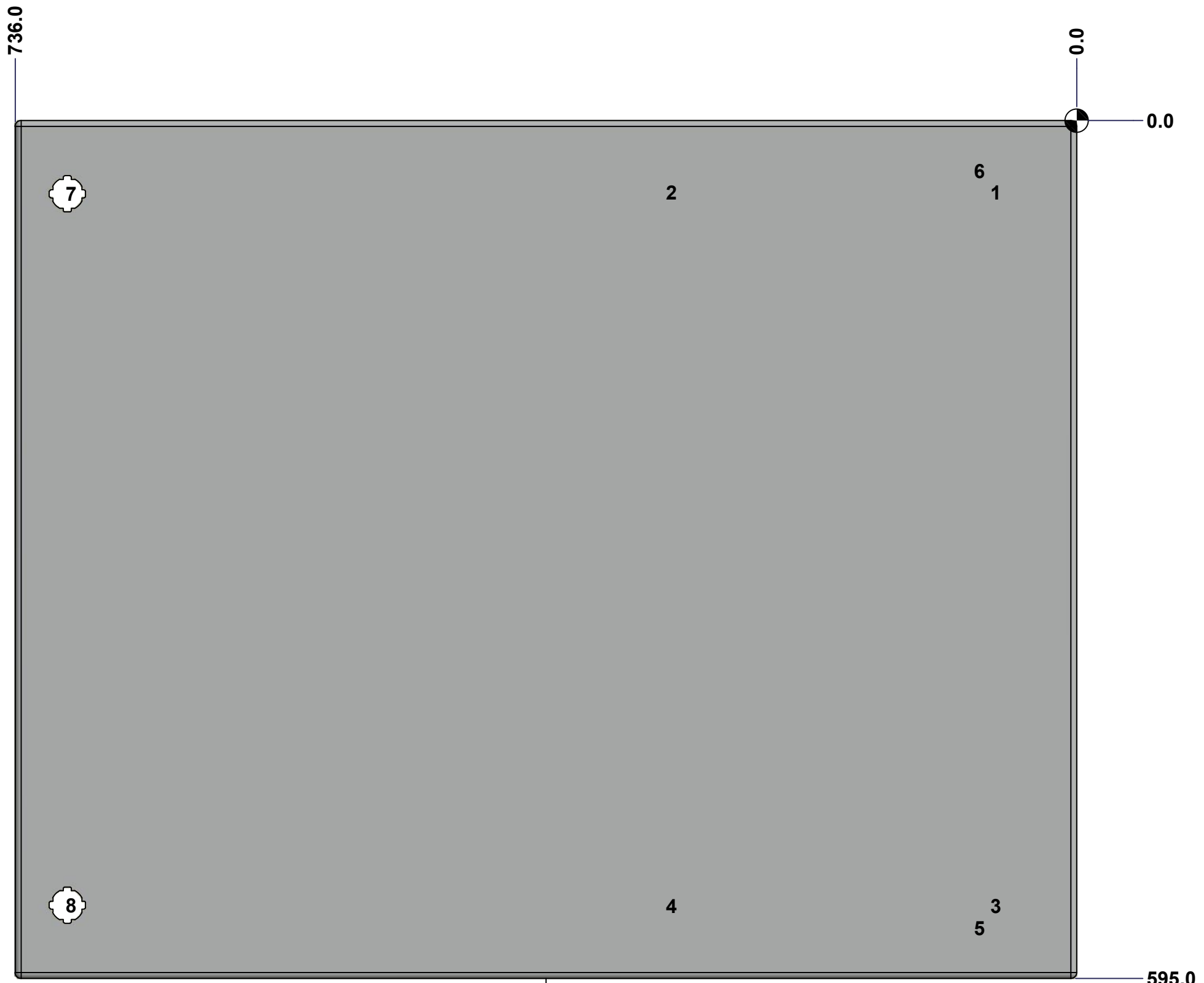

FRONT

| | | |
|--|--|----------------------|
| | Description 6500WD 600mm x 500mm Top Cover | Status (NULL) |
| | Part Number Numéro Pièce 6500WD0605TD | Rev. 8 0 9 |

This drawing is confidential and must not be reproduced or used without the consent of EXM

Ce dessin est confidentiel et ne doit pas être reproduit ou utilisé sans le consentement de EXM

| No. | Revisions | Date | By/Par |
|-----|-----------|------|--------|
| | | | |
| | | | |
| | | | |
| | | | |
| | | | |

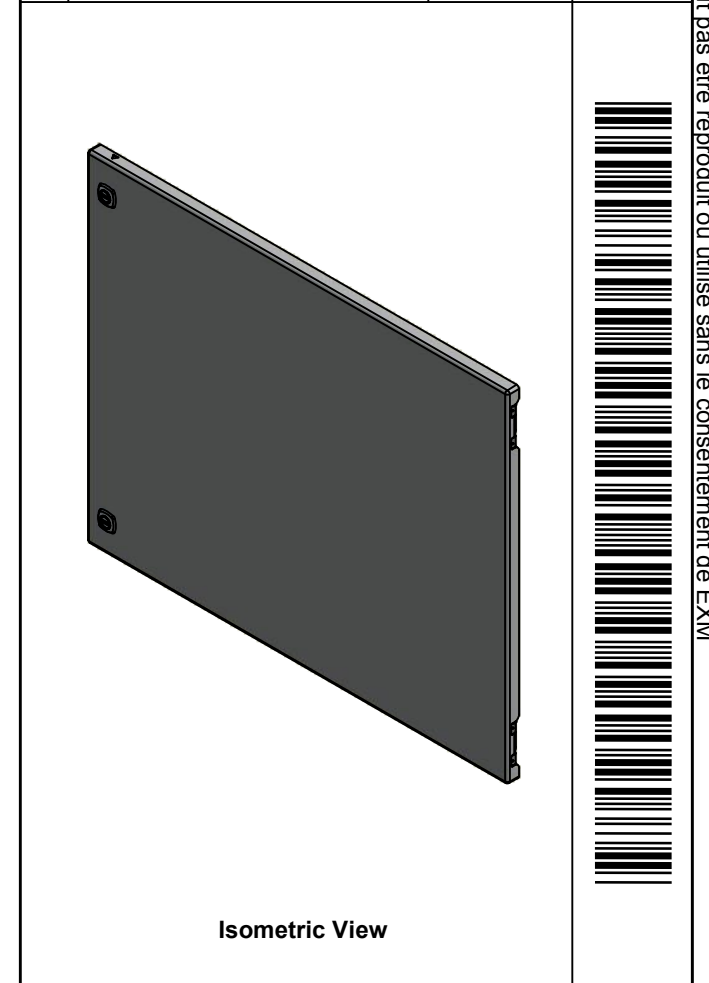

 Tél: (450) 979-4373
 Fax: (450) 979-4626
www.exmweb.com

Flatness
 Aplatissement
 Max 3.0mm
Projection

| | |
|--|-----------------|
| Customer Client | Date |
| Drawn By / Dessiné Par: BoxCad: BoxCad | Date: 22-Jul-22 |

Material / Matière: 14 Ga Cold Rolled A1008 CS Type B (1.7mm)

Color / Couleur: Light Grey RAL7035 Finish / Fini: Rough Textured

Description: 6500WD 600mm x 500mm Top Cover Detail Rev.

Part Number / Numéro Pièce: **6500WD0605TD** Rev. 0 9

| Qty | Part Number | Rev | Description |
|------------|----------------|-----|--|
| 2 | STK-Q-16080 | 0 | Ground Stud M6 x 16mm |
| 1 | STK-P-03820R | 0 | Powder Paint (Light Grey / Rough Textured) |
| 2 | STK-Q-46020-12 | 5 | 5412 ES Vertical Door Stiffener 12" |
| 4 | STK-Q-16055 | 1 | M6 x 18mm Stud (No Paint Cap Required) |
| 1 | 6500WD0605TD-P | 0 | 6500WD 600mm x 500mm Top Cover Part |
| 1 | 6500WD0605TD-G | 0 | 6500WD 120mm x 600mm Top Cover Gasket |
| 2 | STK-K-09800 | 10 | 5412 ES Hinge with 2 Captive Hinge Pins |
| 4 | STK-Q-07220 | 1 | M6 Nylon Insert Lock Nut |
| 2 | 880 SCQ4-SL | 6 | 5412 ES 1/4 Turn Lock |
| Parts List | | | |