

This drawing is confidential and must not be reproduced or used without the consent of EXM

Ce dessin est confidentiel et ne doit pas être reproduit ou utilisé sans le consentement de EXM

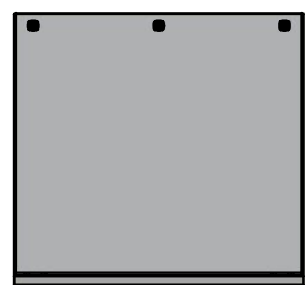

TOP



BACK

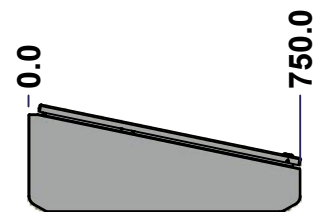

LEFT

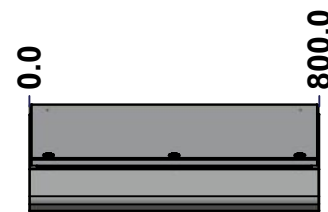

FRONT

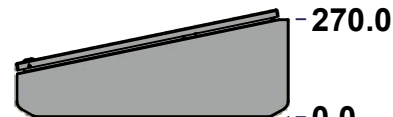

RIGHT

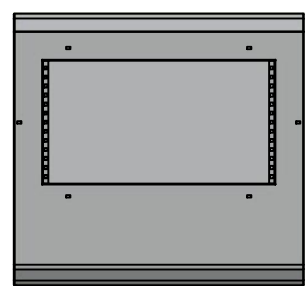

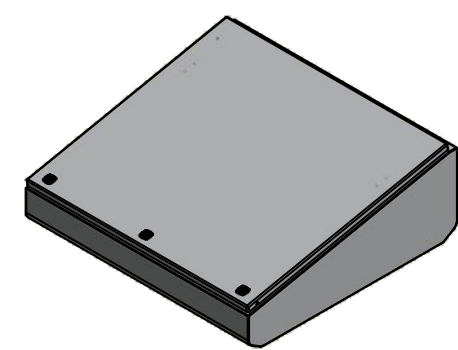

BOTTOM

No.	Revisions	Date	By/Par

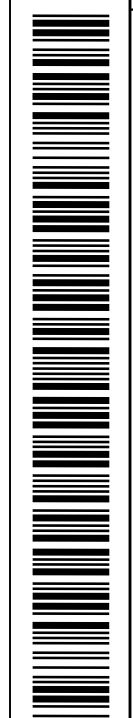

Isometric View

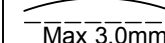
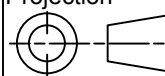

 Tél: (450) 979-4373 Fax: (450) 979-4626 www.exmweb.com		Flatness Aplatissement  Max 3.0mm Projection 
Customer Client	Date	
Drawn By Dessiné Par	BoxCad: BoxCad	Date 14-Jul-21
Material Matière	16 Ga Cold Rolled A1008 CS Type B (1.4mm)	
Color Couleur	Light Grey RAL7035	Finish Fini Rough Textured
Description 6500WD 120mm x 800mm x 500mm Assembly		Detail Rev.
Part Number Numéro Pièce	6500WD0805	Rev. 1 0 / 9

SEE BILL OF MATERIAL ON LAST PAGE

This drawing is confidential and must not be reproduced or used without the consent of EXM

Ce dessin est confidentiel et ne doit pas être reproduit ou utilisé sans le consentement de EXM

NOTE	
ITEM	DESCRIPTION
1	NEMA 12/13 Enclosure
2	C/W Standard ground studs on box and cover
3	C/W Standard door stiffener
4	W/O Inner panel
5	C/W Standard inner panel mounting studs

No.	Revisions	Date	By/Par

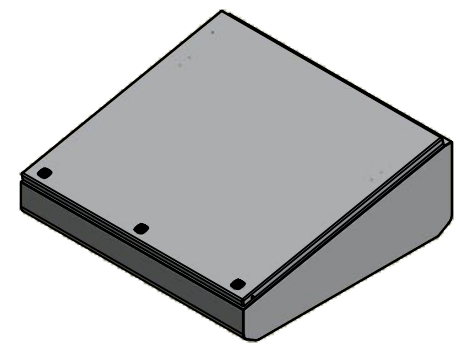

Isometric View

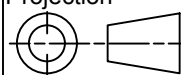
 Tél: (450) 979-4373 Fax: (450) 979-4626 www.exmweb.com	Flatness Aplatissement Max 3.0mm
	Projection 
Customer Client	Date
Drawn By Dessiné Par BoxCad: BoxCad	Date 14-Jul-21
Material Matière 16 Ga Cold Rolled A1008 CS Type B (1.4mm)	

PACKING		
ITEM	QTY	DESCRIPTION
Cardboard corner	2	To reinforced for the plastic strap tightening
Honeycomb angle	4	To protect each corners
Plastic strap- Green	2	To secure the enclosure to the wood pallet
Wood pallet	1	Standard wood pallet
Flat cardboard	1	Between the enclosure and the wood pallet
Packaging label	1	White label with product number

Qty	Part Number	Rev	Description
8	STK-Q-05025	1	M5 x 9.5mm Thread Rolling Screw
2	880 GS115	0	Gas Spring 115N/12Kg/26Lbs
1	6500WD0805TD	0	6500WD 800mm x 500mm Top Cover
1	6500WD0805B	0	6500WD 120mm x 800mm x 500mm Body
2	STK-Q-04050-07	7	M6 x 7mm Hexagon Socket Head Machine Screw with Nyseal
4	STK-Q-08100	1	M5 Nylon Insert Lock Nut
Parts List			

Color Couleur Light Grey RAL7035	Finish Fini Rough Textured
Description 6500WD 120mm x 800mm x 500mm Assembly	
Part Number Numéro Pièce 6500WD0805	Rev. 2 0

This drawing is confidential and must not be reproduced or used without the consent of EXM

Ce dessin est confidentiel et ne doit pas être reproduit ou utilisé sans le consentement de EXM

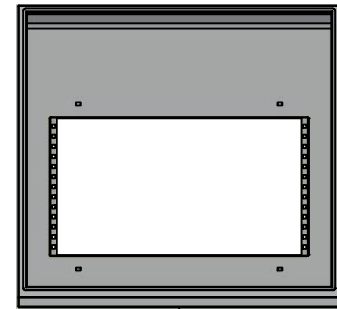

TOP



BACK

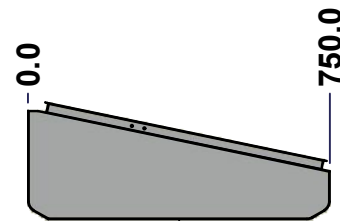

LEFT

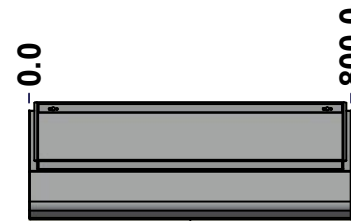

FRONT

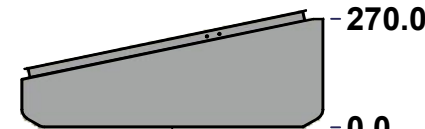

RIGHT

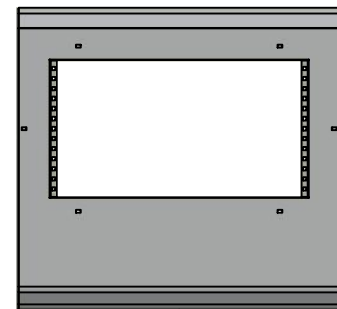

BOTTOM

No.	Revisions	Date	By/Par

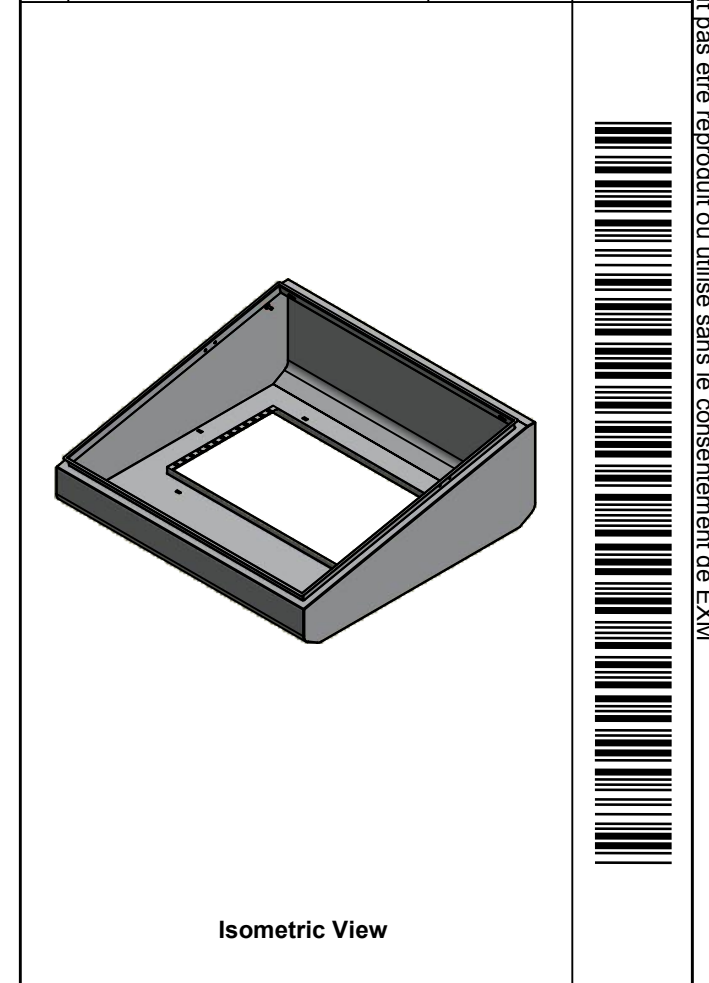

Isometric View

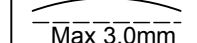
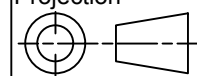

 Tél: (450) 979-4373 Fax: (450) 979-4626 www.exmweb.com		Flatness Aplatissement  Max 3.0mm Projection 
Customer Client	Date	
Drawn By Dessiné Par	BoxCad: BoxCad	Date 14-Jul-21
Material Matière	16 Ga Cold Rolled A1008 CS Type B (1.4mm)	
Color Couleur	Light Grey RAL7035	Finish Fini Rough Textured
Description 6500WD 120mm x 800mm x 500mm Body		Detail Rev.
Part Number Numéro Pièce	Rev. 0	3 9

SEE BILL OF MATERIAL ON LAST PAGE

6500WD0805B

This drawing is confidential and must not be reproduced or used without the consent of EXM

Ce dessin est confidentiel et ne doit pas être reproduit ou utilisé sans le consentement de EXM

STANDARD FEATURES ARE NOT LISTED IN THIS HOLE TABLE			
HOLE TABLE - RIGHT VIEW (CUSTOM FEATURE ONLY)			
CUT-OUT	XDIM	YDIM	DESCRIPTION
1	70.0	230.0	GND STUD M6 x 16mm (Inside)

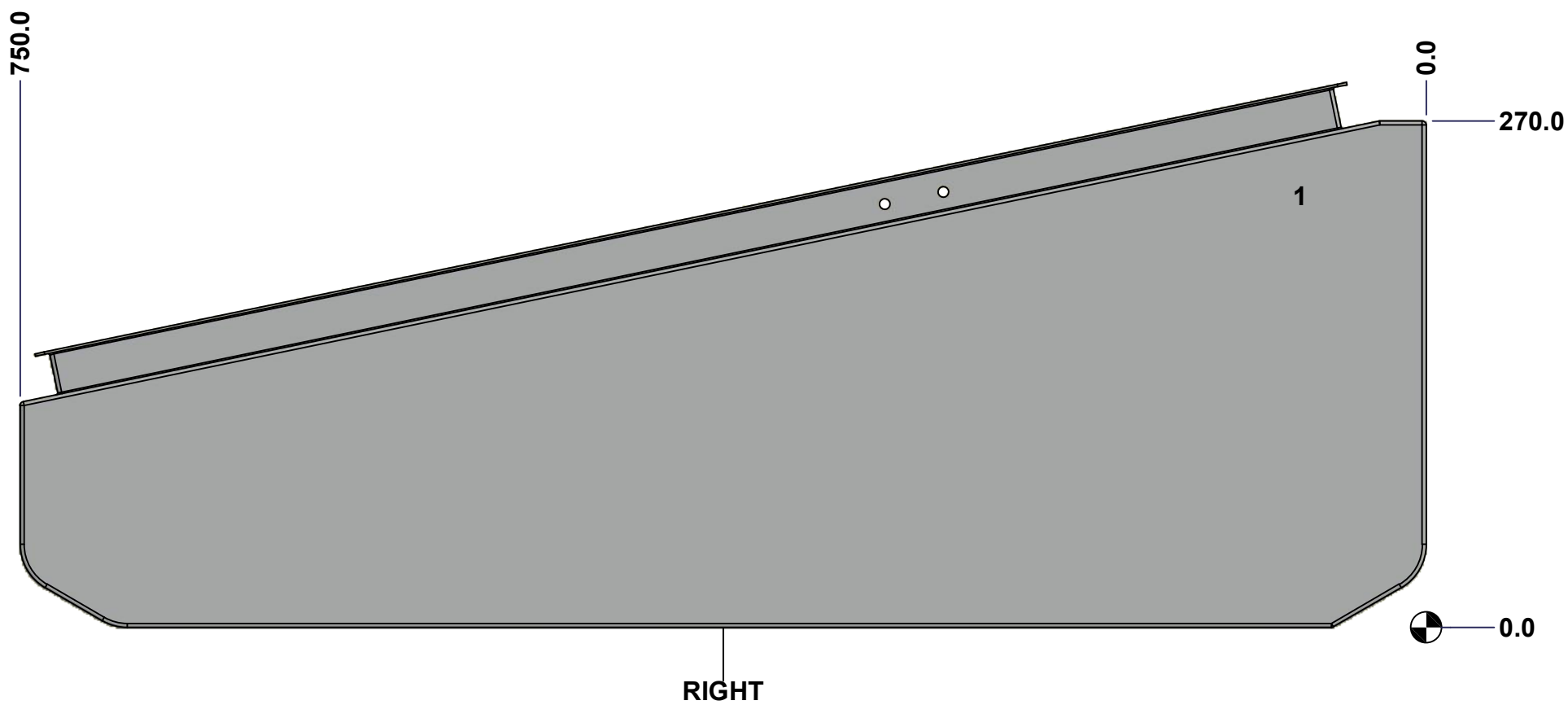

	Description 6500WD 120mm x 800mm x 500mm Body	Status (NULL)
	Part Number Numéro Pièce 6500WD0805B	Rev. 4 0 / 9

This drawing is confidential and must not be reproduced or used without the consent of EXM

Ce dessin est confidentiel et ne doit pas être reproduit ou utilisé sans le consentement de EXM

STANDARD FEATURES ARE NOT LISTED IN THIS HOLE TABLE			
HOLE TABLE - LEFT VIEW (CUSTOM FEATURE ONLY)			
CUT-OUT	XDIM	YDIM	DESCRIPTION
1	70.0	230.0	GND STUD M6 x 16mm (Inside)

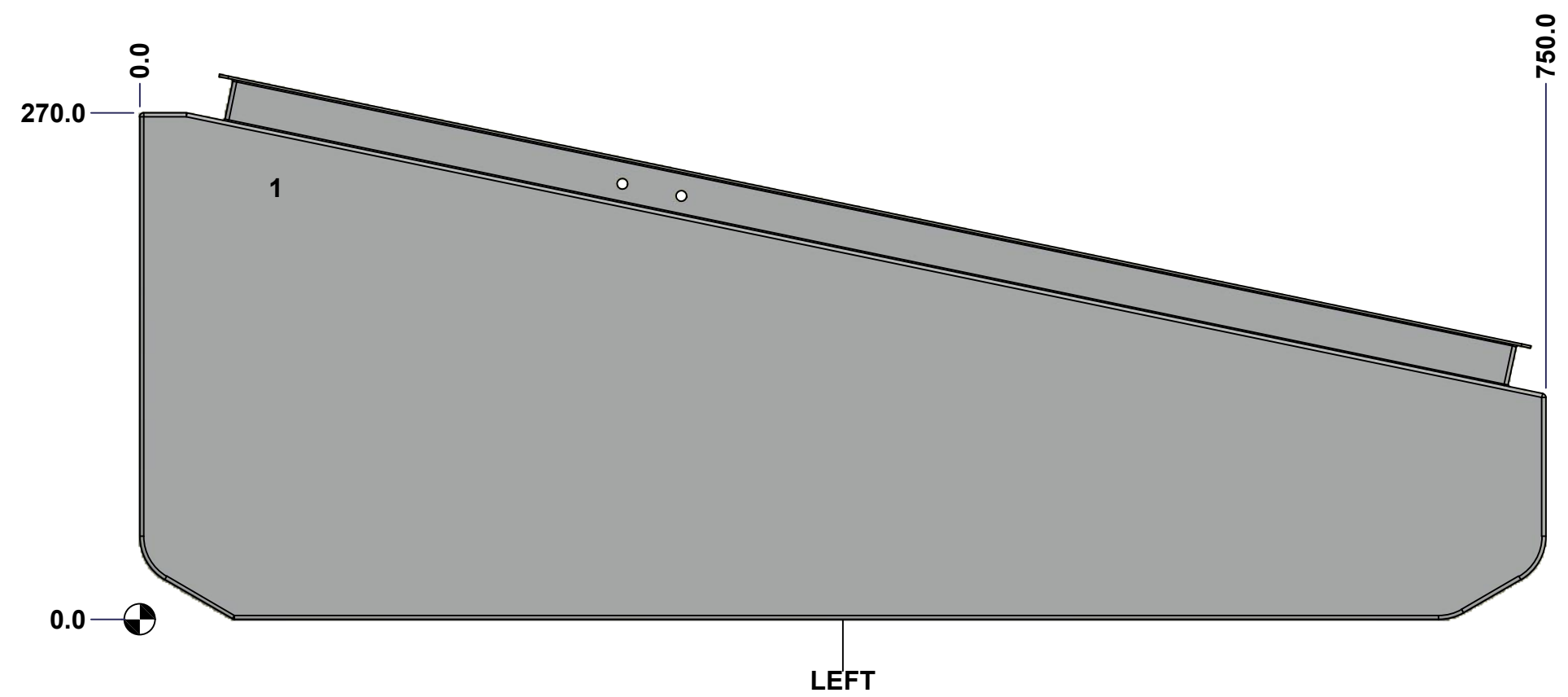

	Description 6500WD 120mm x 800mm x 500mm Body	Status (NULL)
	Part Number Numéro Pièce 6500WD0805B	Rev. 5 0 / 9

This drawing is confidential and must not be reproduced or used without the consent of EXM

Ce dessin est confidentiel et ne doit pas être reproduit ou utilisé sans le consentement de EXM

No.	Revisions	Date	By/Par

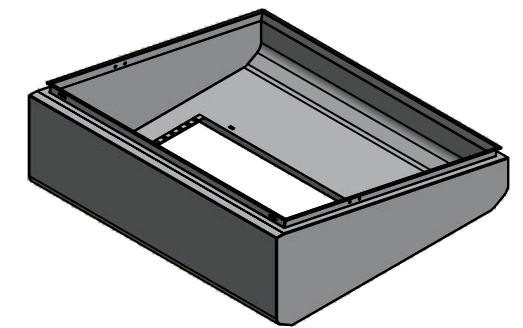

Isometric View



Tél: (450) 979-4373
 Fax: (450) 979-4626
www.exmweb.com

Flatness
Aplatissement
Max 3.0mm
Projection

Customer Client	Date
Drawn By / Dessiné Par: BoxCad: BoxCad	Date: 14-Jul-21
Material / Matière: 16 Ga Cold Rolled A1008 CS Type B (1.4mm)	
Color / Couleur: Light Grey RAL7035	Finish / Fini: Rough Textured

Qty	Part Number	Rev	Description
2	STK-Q-16080	0	Ground Stud M6 x 16mm
1	STK-P-03820R	0	Powder Paint (Light Grey / Rough Textured)
1	6500WD0805B-P	0	6500WD 120mm x 800mm x 500mm Body Part
Parts List			

Description: 6500WD 120mm x 800mm x 500mm Body	Detail Rev.
Part Number / Numéro Pièce: 6500WD0805B	Rev. 0 / 6

This drawing is confidential and must not be reproduced or used without the consent of EXM

Ce dessin est confidentiel et ne doit pas être reproduit ou utilisé sans le consentement de EXM



TOP

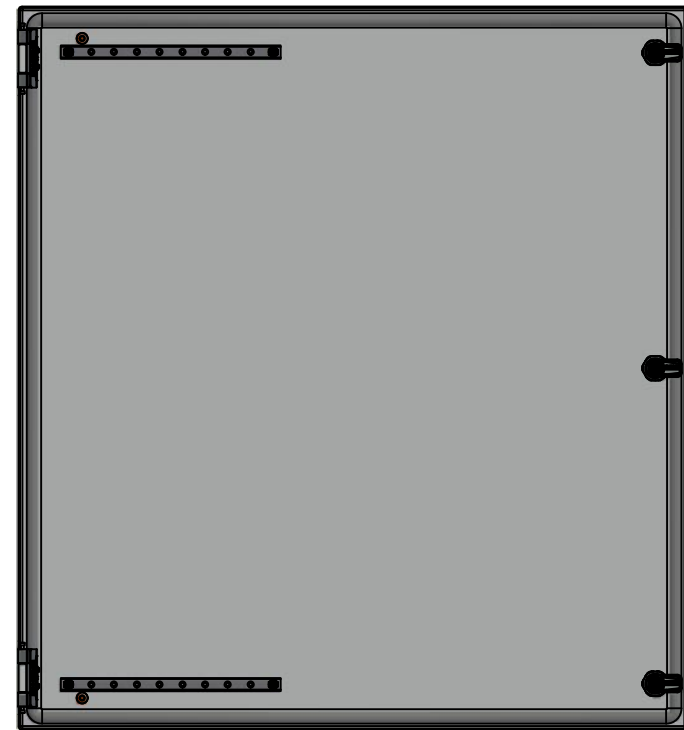

BACK

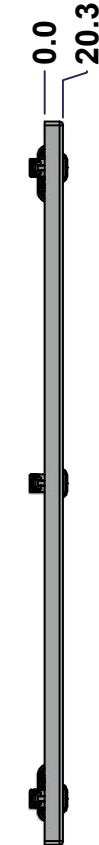

LEFT

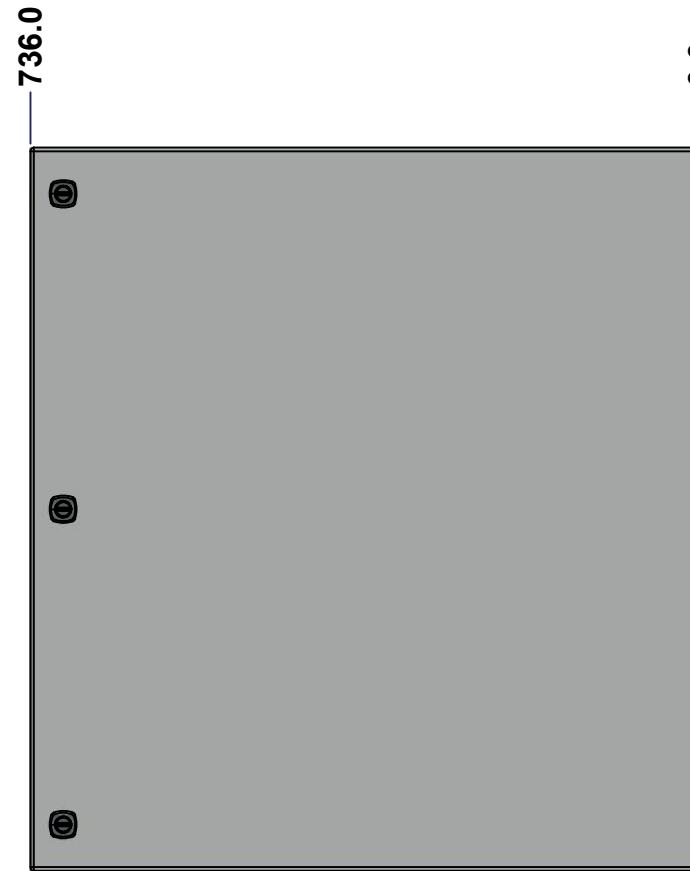

FRONT

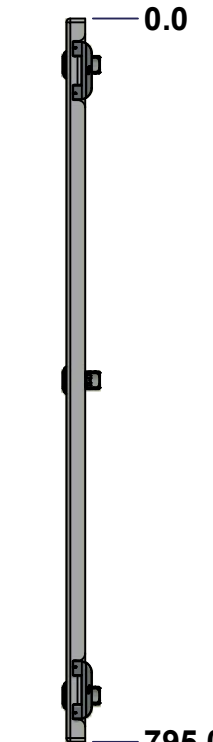

RIGHT



BOTTOM

No.	Revisions	Date	By/Par

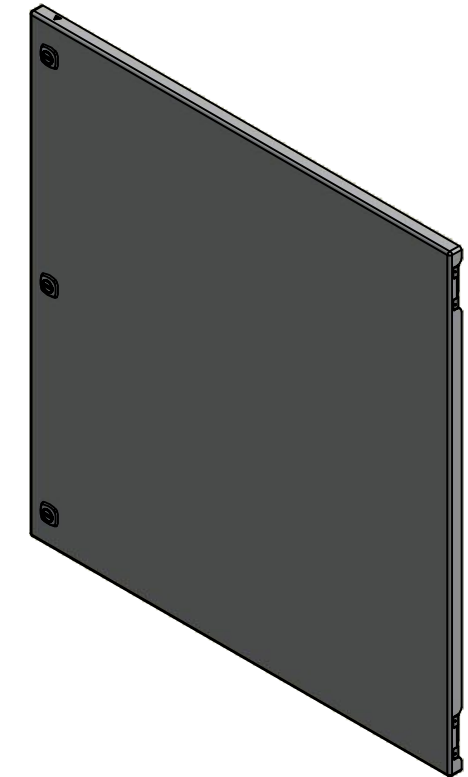

Isometric View



Tél: (450) 979-4373
 Fax: (450) 979-4626
www.exmweb.com

Flatness
Aplatissement

Max 3.0mm

Projection

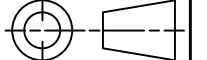

Customer Client _____ Date _____

Drawn By Dessiné Par BoxCad: BoxCad Date 14-Jul-21

Material Matière 14 Ga Cold Rolled A1008 CS Type B (1.7mm)

Color Couleur Light Grey RAL7035 Finish Fini Rough Textured

Description 6500WD 800mm x 500mm Top Cover Detail Rev. _____

Part Number Numéro Pièce **6500WD0805TD** Rev. **0** 7/9

SEE BILL OF MATERIAL ON LAST PAGE

This drawing is confidential and must not be reproduced or used without the consent of EXM

Ce dessin est confidentiel et ne doit pas être reproduit ou utilisé sans le consentement de EXM

STANDARD FEATURES ARE NOT LISTED IN THIS HOLE TABLE

HOLE TABLE - FRONT VIEW (CUSTOM FEATURE ONLY)

CUT-OUT	XDIM	YDIM	DESCRIPTION
1	58.6	50.0	STUD M6 x 18mm (Inside)
2	283.6	50.0	STUD M6 x 18mm (Inside)
3	58.6	745.0	STUD M6 x 18mm (Inside)
4	283.6	745.0	STUD M6 x 18mm (Inside)

5	70.0	760.0	GND STUD M6 x 16mm (Inside)
6	70.0	35.0	GND STUD M6 x 16mm (Inside)
7	699.8	50.8	LOCK 880 SCQ4-SL @ 270.0°
8	699.8	397.5	LOCK 880 SCQ4-SL @ 270.0°
9	699.8	744.2	LOCK 880 SCQ4-SL @ 270.0°

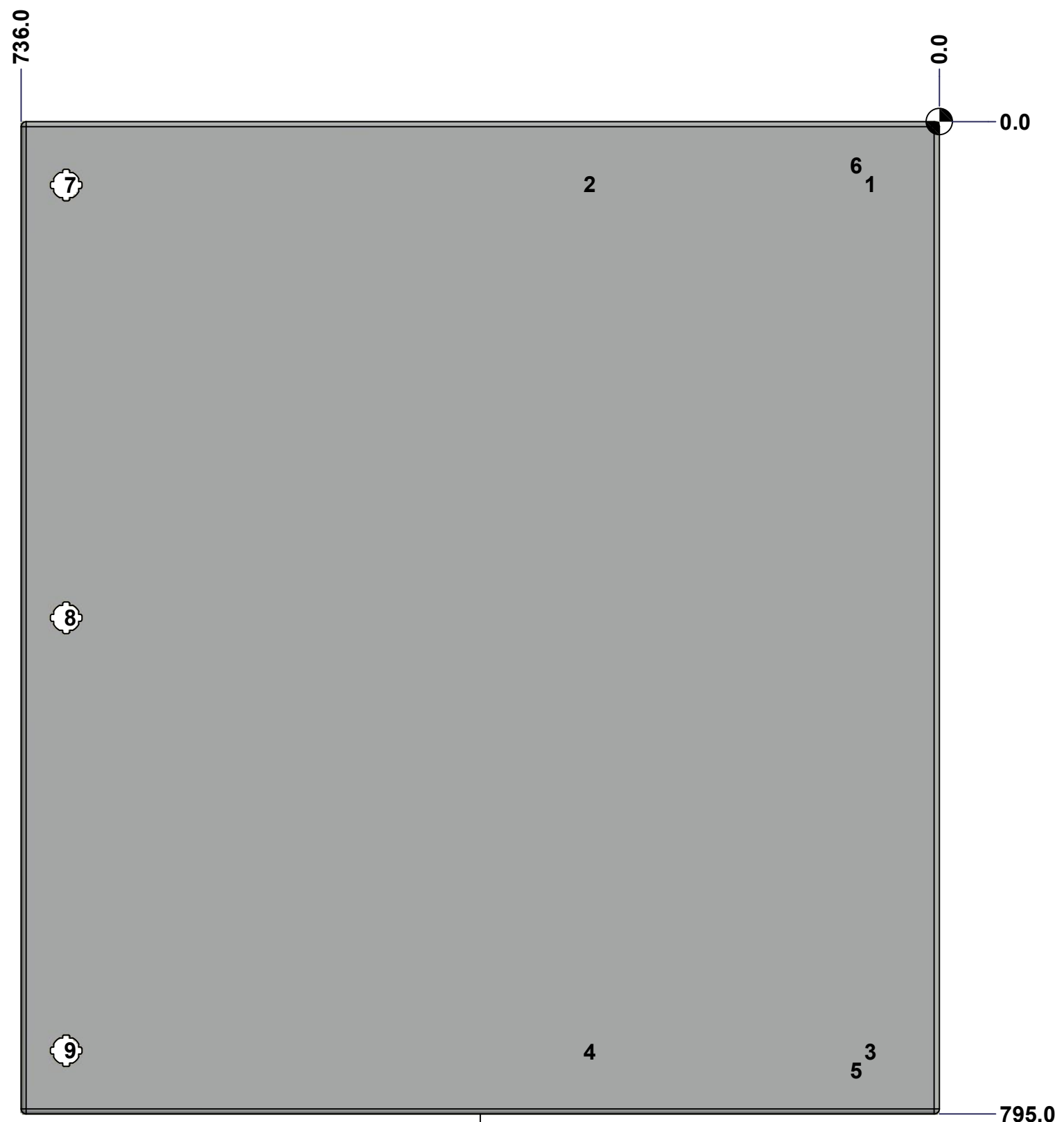

FRONT

	Description 6500WD 800mm x 500mm Top Cover	Status (NULL)
	Part Number Numéro Pièce 6500WD0805TD	Rev. 8 0

This drawing is confidential and must not be reproduced or used without the consent of EXM

Ce dessin est confidentiel et ne doit pas être reproduit ou utilisé sans le consentement de EXM

No.	Revisions	Date	By/Par

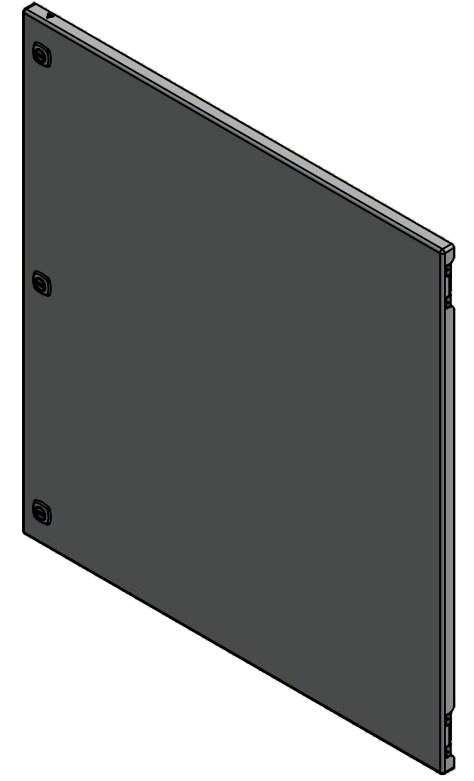

Isometric View



Tél: (450) 979-4373
 Fax: (450) 979-4626
www.exmweb.com

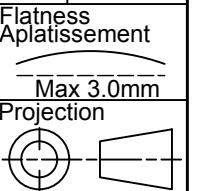

Customer Client	Date
Drawn By / Dessiné Par: BoxCad: BoxCad	Date: 14-Jul-21
Material / Matière: 14 Ga Cold Rolled A1008 CS Type B (1.7mm)	

Color / Couleur: Light Grey RAL7035	Finish / Fini: Rough Textured
-------------------------------------	-------------------------------

Description: 6500WD 800mm x 500mm Top Cover	Detail Rev.
---	-------------

Part Number / Numéro Pièce: 6500WD0805TD	Rev. 0	9
---	--------	---

Qty	Part Number	Rev	Description
2	STK-Q-16080	0	Ground Stud M6 x 16mm
1	STK-P-03820R	0	Powder Paint (Light Grey / Rough Textured)
2	STK-Q-46020-12	5	5412 ES Vertical Door Stiffener 12"
4	STK-Q-16055	1	M6 x 18mm Stud (No Paint Cap Required)
1	6500WD0805TD-P	0	6500WD 800mm x 500mm Top Cover Part
1	6500WD0805TD-G	0	6500WD 120mm x 800mm Top Cover Gasket
2	STK-K-09800	10	5412 ES Hinge with 2 Captive Hinge Pins
4	STK-Q-07220	1	M6 Nylon Insert Lock Nut
3	880 SCQ4-SL	6	5412 ES 1/4 Turn Lock
Parts List			