

This drawing is confidential and must not be reproduced or used without the consent of EXM

Ce dessin est confidentiel et ne doit pas être reproduit ou utilisé sans le consentement de EXM

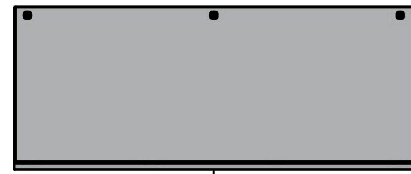

TOP



BACK

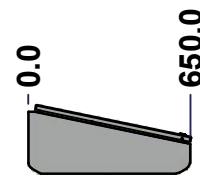

LEFT



FRONT



RIGHT



BOTTOM

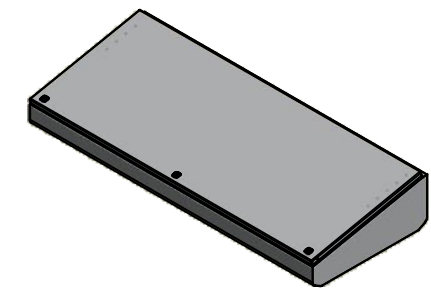

Isometric View

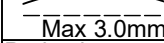
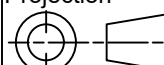

No.	Revisions	Date	By/Par

 Tél: (450) 979-4373 Fax: (450) 979-4626 www.exmweb.com		Flatness Aplatissement  Max 3.0mm Projection 
Customer Client	Date	
Drawn By Dessiné Par	BoxCad: BoxCad	Date 7/22/2022
Material Matière	16 Ga Cold Rolled A1008 CS Type B (1.4mm)	
Color Couleur	Light Grey RAL7035	Finish Fini Rough Textured
Description 6500WDFD 200mm x 1600mm x 400mm Assembly		Detail Rev.
Part Number Numéro Pièce	6500WDFD1604	Rev. 1 0 / 9

SEE BILL OF MATERIAL ON LAST PAGE

This drawing is confidential and must not be reproduced or used without the consent of EXM

Ce dessin est confidentiel et ne doit pas être reproduit ou utilisé sans le consentement de EXM

NOTE	
ITEM	DESCRIPTION
1	NEMA 12/13 Enclosure
2	C/W Standard ground studs on box and cover
3	C/W Standard door stiffener
4	W/O Inner panel
5	C/W Standard inner panel mounting studs

No.	Revisions	Date	By/Par

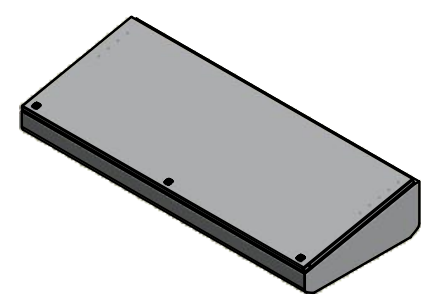

Isometric View

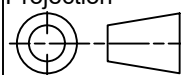
 Tél: (450) 979-4373 Fax: (450) 979-4626 www.exmweb.com	Flatness Aplatissement
	Max 3.0mm Projection 
Customer Client	Date
Drawn By Dessiné Par BoxCad: BoxCad	Date 7/22/2022
Material Matière 16 Ga Cold Rolled A1008 CS Type B (1.4mm)	

PACKING		
ITEM	QTY	DESCRIPTION
Cardboard corner	2	To reinforced for the plastic strap tightening
Honeycomb angle	4	To protect each corners
Plastic strap- Green	2	To secure the enclosure to the wood pallet
Wood pallet	1	Standard wood pallet
Flat cardboard	1	Between the enclosure and the wood pallet
Packaging label	1	White label with product number

Qty	Part Number	Rev	Description
8	STK-Q-05025	1	M5 x 9.5mm Thread Rolling Screw
2	880 GS115	0	Gas Spring 115N/12Kg/26Lbs
1	6500WDFD1604TD	0	6500WDFD 1600mm x 400mm Top Cover
1	6500WDFD1604B	0	6500WDFD 200mm x 1600mm x 400mm Body
4	STK-Q-04050-07	7	M6 x 7mm Hexagon Socket Head Machine Screw with Nyseal
4	STK-Q-08100	1	M5 Nylon Insert Lock Nut
Parts List			

Color Couleur Light Grey RAL7035	Finish Fini Rough Textured
Description 6500WDFD 200mm x 1600mm x 400mm Assembly	
Part Number Numéro Pièce 6500WDFD1604	Detail Rev. Rev. 2 0 / 9

This drawing is confidential and must not be reproduced or used without the consent of EXM

Ce dessin est confidentiel et ne doit pas être reproduit ou utilisé sans le consentement de EXM



TOP



BACK

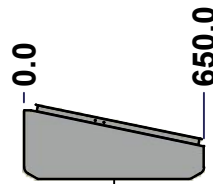

LEFT



FRONT

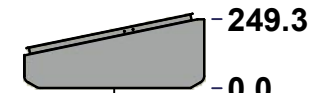

RIGHT

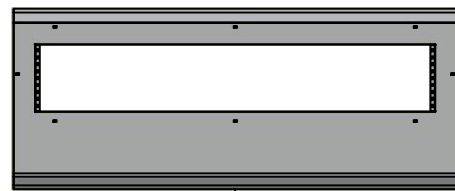

BOTTOM

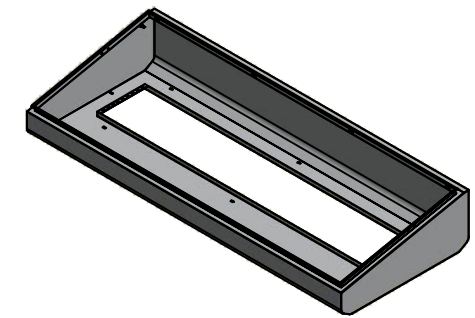

Isometric View

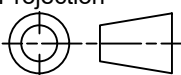

No.	Revisions	Date	By/Par

 Tél: (450) 979-4373 Fax: (450) 979-4626 www.exmweb.com		Flatness Aplatissement Max 3.0mm Projection 
Customer Client	Date	
Drawn By Dessiné Par	BoxCad: BoxCad	Date 7/22/2022
Material Matière	16 Ga Cold Rolled A1008 CS Type B (1.4mm)	
Color Couleur	Light Grey RAL7035	Finish Fini Rough Textured
Description	Detail Rev.	
6500WDFD 200mm x 1600mm x 400mm Body		
Part Number Numéro Pièce	Rev.	3
6500WDFD1604B	0	9

SEE BILL OF MATERIAL ON LAST PAGE

This drawing is confidential and must not be reproduced or used without the consent of EXM

Ce dessin est confidentiel et ne doit pas être reproduit ou utilisé sans le consentement de EXM

STANDARD FEATURES ARE NOT LISTED IN THIS HOLE TABLE			
HOLE TABLE - RIGHT VIEW (CUSTOM FEATURE ONLY)			
CUT-OUT	XDIM	YDIM	DESCRIPTION
1	70.0	210.0	GND STUD M6 x 16mm (Inside)

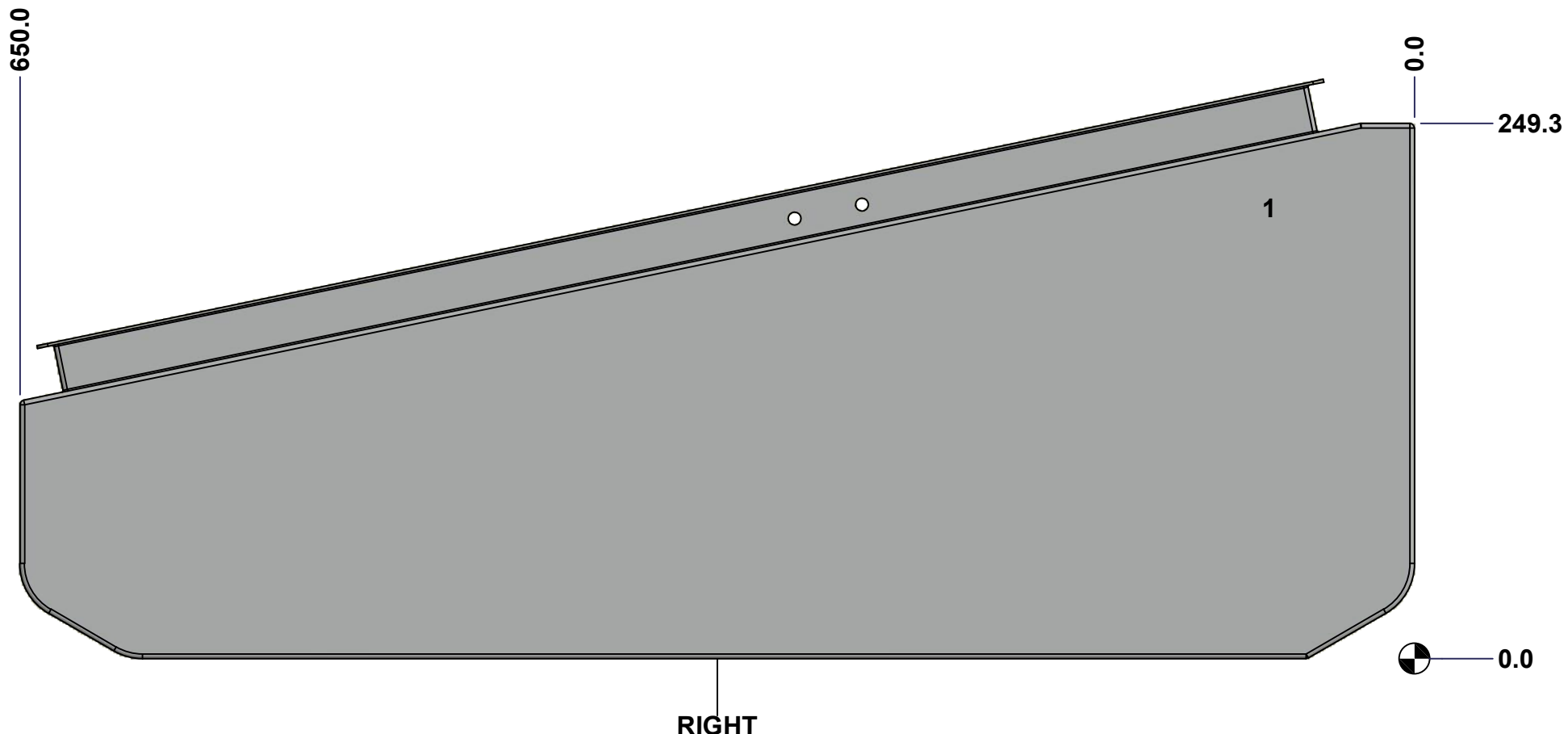

	Description 6500WDFD 200mm x 1600mm x 400mm Body		Status (NULL)
	Part Number Numéro Pièce 6500WDFD1604B		Rev. 4 0 / 9

This drawing is confidential and must not be reproduced or used without the consent of EXM

Ce dessin est confidentiel et ne doit pas être reproduit ou utilisé sans le consentement de EXM

STANDARD FEATURES ARE NOT LISTED IN THIS HOLE TABLE			
HOLE TABLE - LEFT VIEW (CUSTOM FEATURE ONLY)			
CUT-OUT	XDIM	YDIM	DESCRIPTION
1	70.0	210.0	GND STUD M6 x 16mm (Inside)

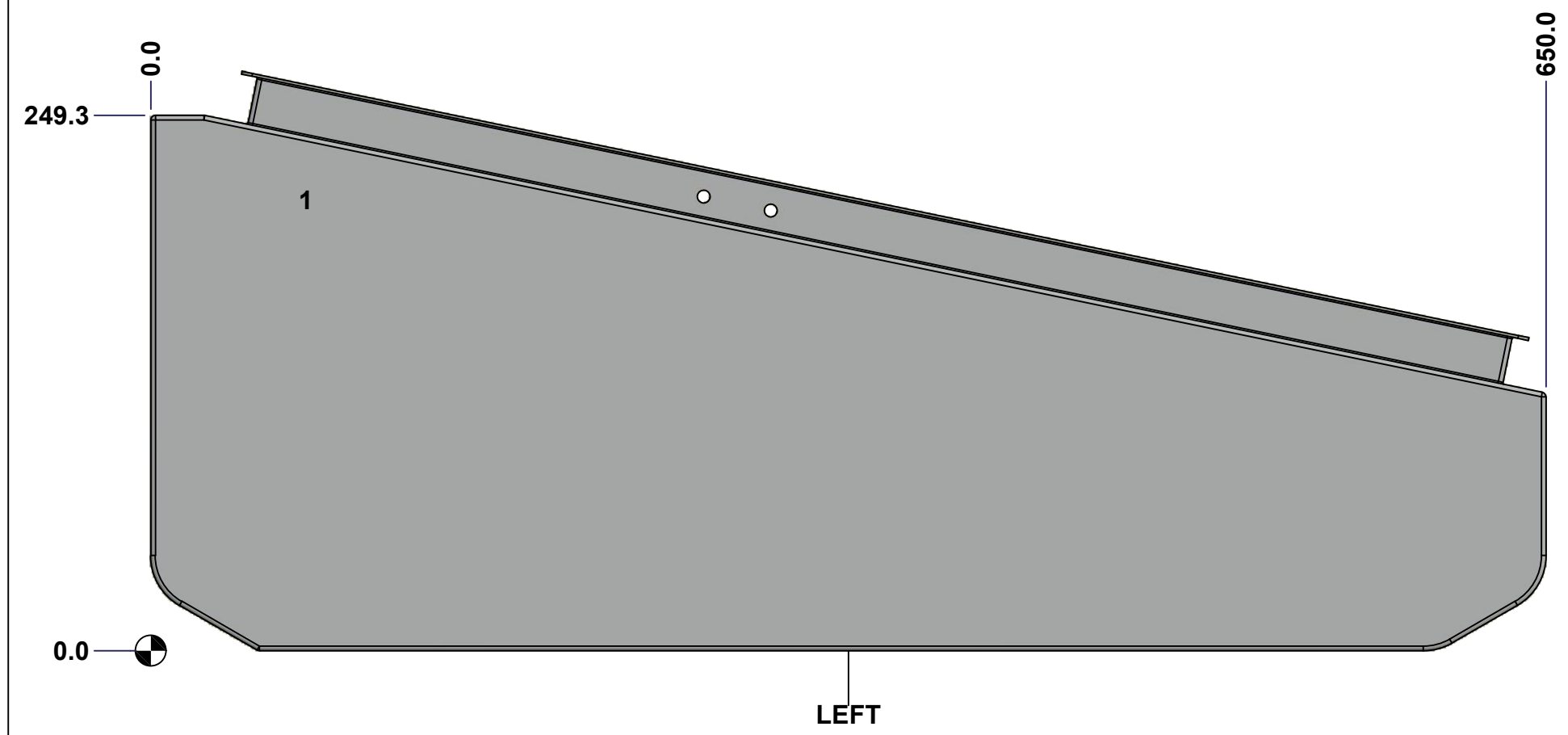

	Description 6500WDFD 200mm x 1600mm x 400mm Body	Status (NULL)
	Part Number Numéro Pièce 6500WDFD1604B	Rev. 5 0 / 9

This drawing is confidential and must not be reproduced or used without the consent of EXM

Ce dessin est confidentiel et ne doit pas être reproduit ou utilisé sans le consentement de EXM

No.	Revisions	Date	By/Par

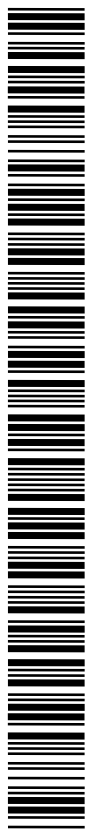
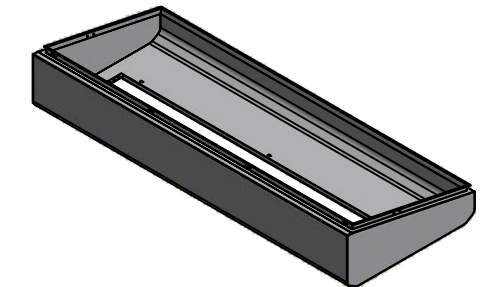

Isometric View

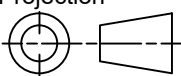
 Tél: (450) 979-4373 Fax: (450) 979-4626 www.exmweb.com	Flatness Aplatissement	Max 3.0mm
	Projection	
Customer Client	Date	
Drawn By Dessiné Par	BoxCad: BoxCad	Date 7/22/2022
Material Matière	16 Ga Cold Rolled A1008 CS Type B (1.4mm)	
Color Couleur	Light Grey RAL7035	Finish Fini
Description		Detail Rev.
6500WDFD 200mm x 1600mm x 400mm Body		
Part Number Numéro Pièce	Rev.	
6500WDFD1604B	0	6 9

Qty	Part Number	Rev	Description
2	STK-Q-16080	0	Ground Stud M6 x 16mm
1	STK-P-03820R	0	Powder Paint (Light Grey / Rough Textured)
1	6500WDFD1604B-P	0	6500WDFD 200mm x 1600mm x 400mm Body Part
Parts List			

This drawing is confidential and must not be reproduced or used without the consent of EXM

Ce dessin est confidentiel et ne doit pas être reproduit ou utilisé sans le consentement de EXM

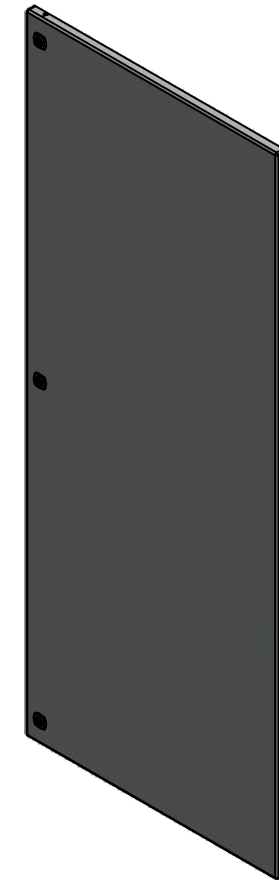
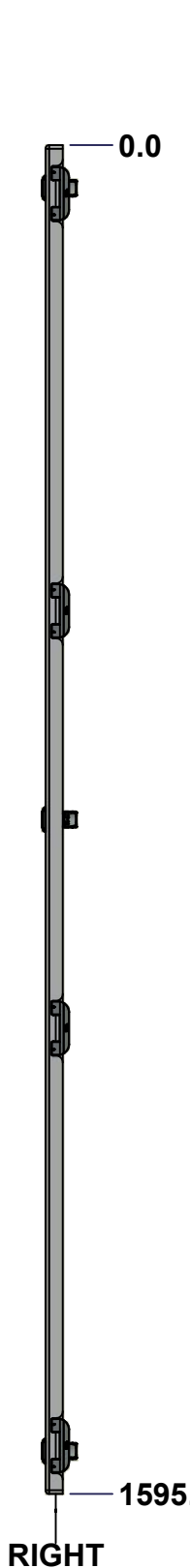
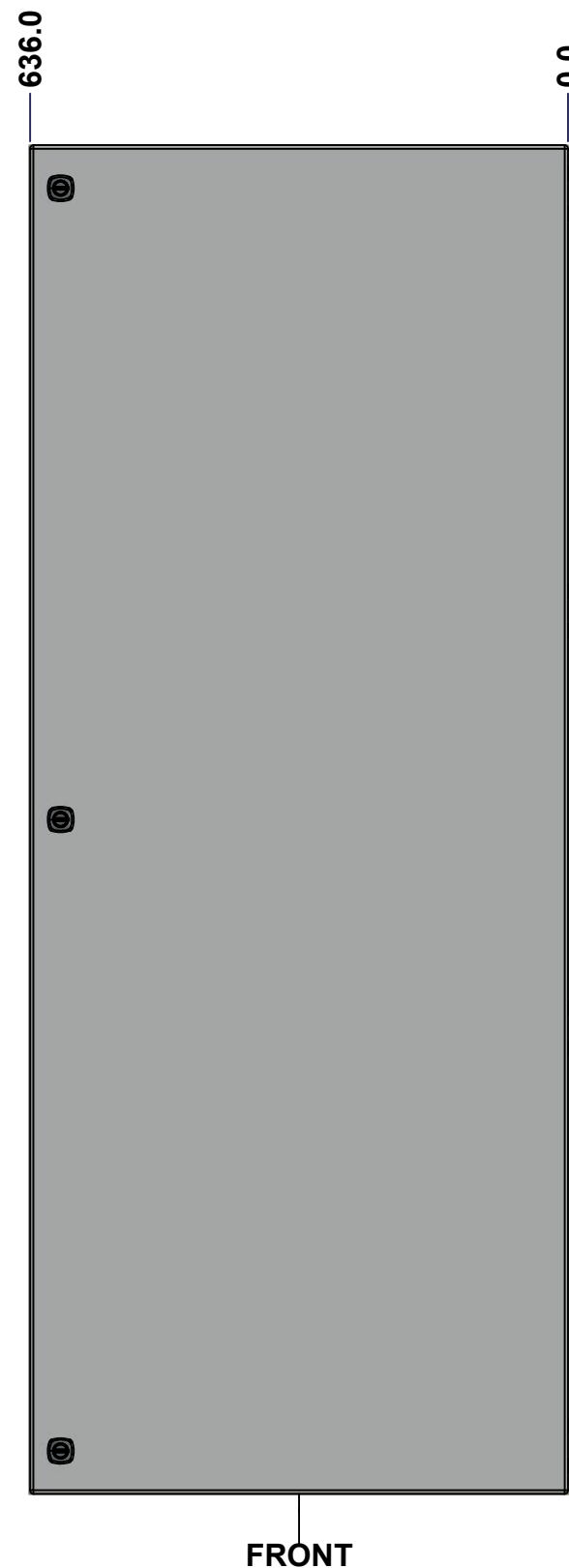
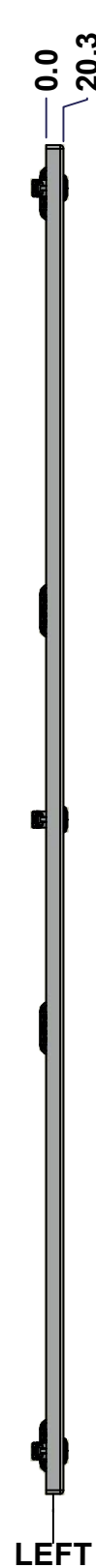
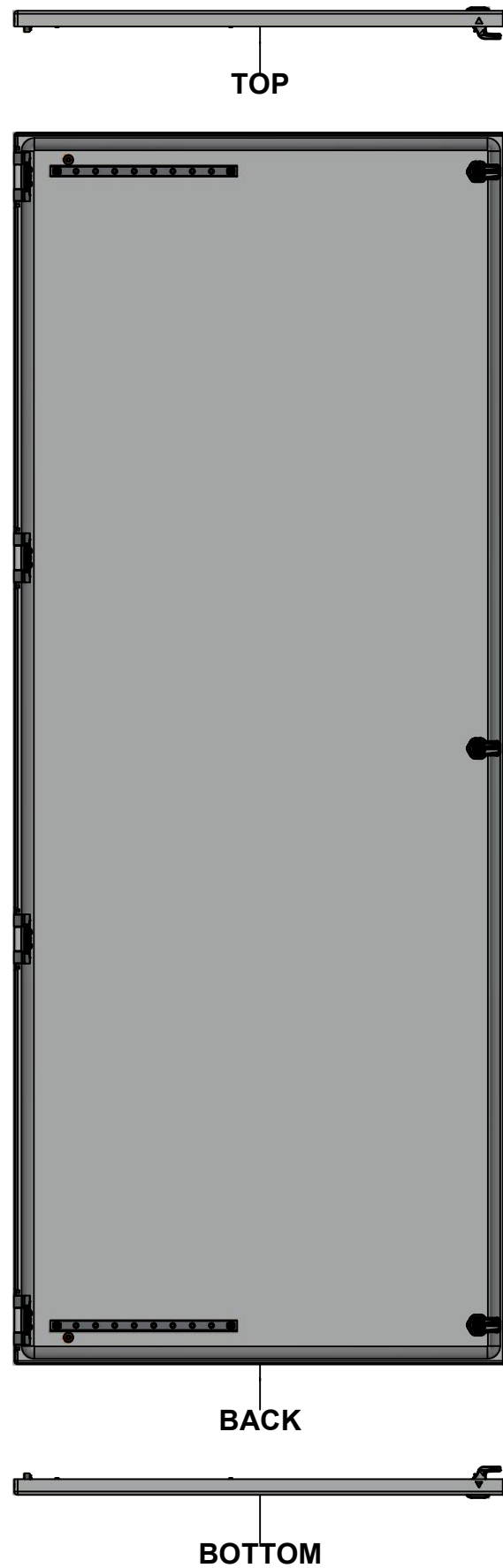

Isometric View

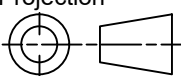

No.	Revisions	Date	By/Par

 Tél: (450) 979-4373 Fax: (450) 979-4626 www.exmweb.com		Flatness Aplatissement Max 3.0mm Projection 
Customer Client	Date	
Drawn By Dessiné Par	BoxCad: BoxCad	Date 7/22/2022
Material Matière	14 Ga Cold Rolled A1008 CS Type B (1.7mm)	
Color Couleur	Light Grey RAL7035	Finish Fini Rough Textured
Description 6500WDFD 1600mm x 400mm Top Cover		Detail Rev.
Part Number Numéro Pièce	Rev. 0	7 9

SEE BILL OF MATERIAL ON LAST PAGE

6500WDFD1604TD

This drawing is confidential and must not be reproduced or used without the consent of EXM

Ce dessin est confidentiel et ne doit pas être reproduit ou utilisé sans le consentement de EXM

STANDARD FEATURES ARE NOT LISTED IN THIS HOLE TABLE

HOLE TABLE - FRONT VIEW (CUSTOM FEATURE ONLY)

CUT-OUT	XDIM	YDIM	DESCRIPTION
1	58.6	50.0	STUD M6 x 18mm (Inside)
2	283.6	50.0	STUD M6 x 18mm (Inside)
3	58.6	1545.0	STUD M6 x 18mm (Inside)
4	283.6	1545.0	STUD M6 x 18mm (Inside)

5	70.0	1560.0	GND STUD M6 x 16mm (Inside)
6	70.0	35.0	GND STUD M6 x 16mm (Inside)
7	599.8	50.8	LOCK 880 SCQ4-SL @ 270.0°
8	599.8	1544.2	LOCK 880 SCQ4-SL @ 270.0°
9	599.8	797.5	LOCK 880 SCQ4-SL @ 270.0°

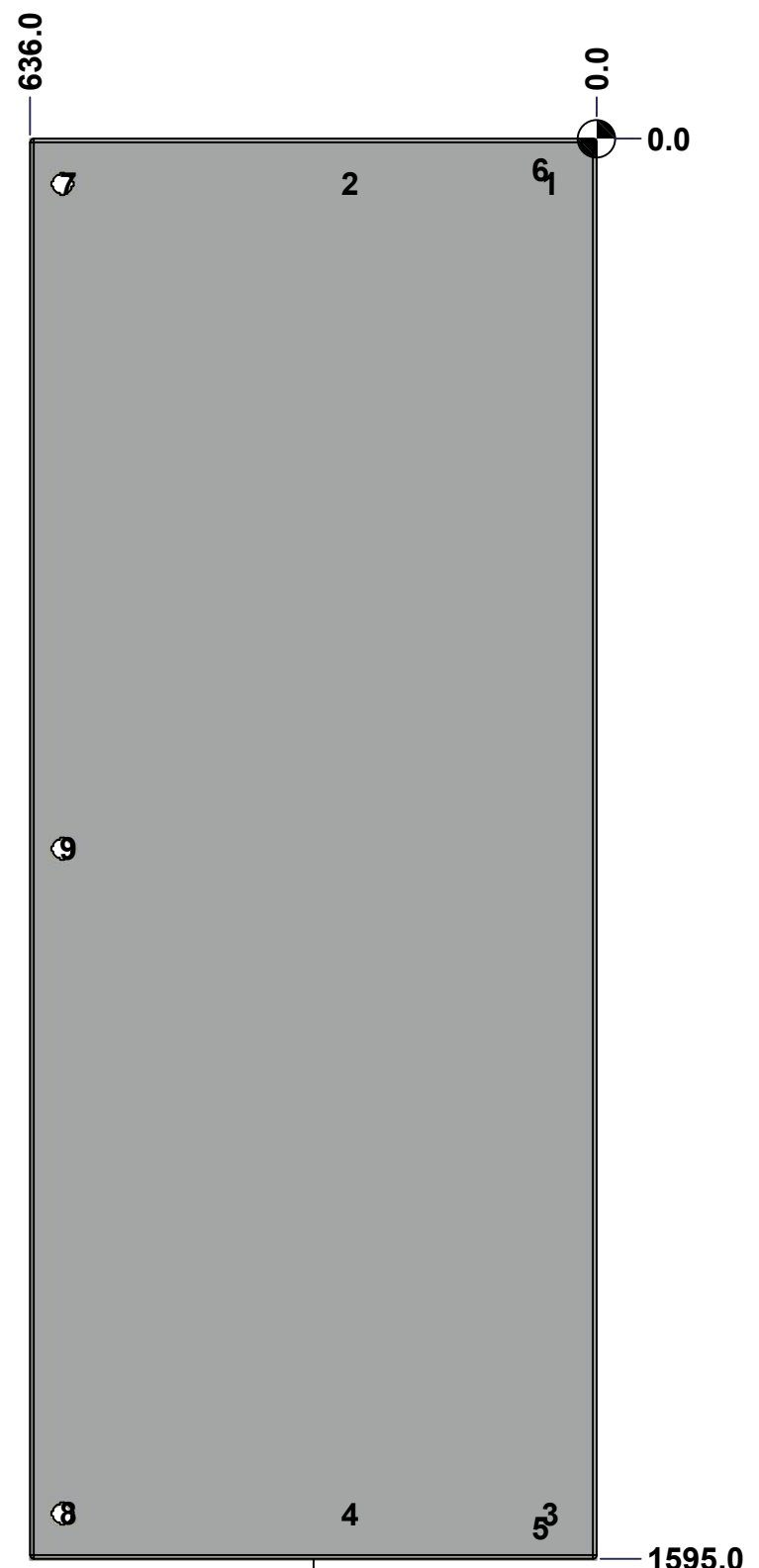

FRONT

	Description 6500WDFD 1600mm x 400mm Top Cover	Status (NULL)
	Part Number Numéro Pièce 6500WDFD1604TD	Rev. 8 0 / 9

This drawing is confidential and must not be reproduced or used without the consent of EXM

Ce dessin est confidentiel et ne doit pas être reproduit ou utilisé sans le consentement de EXM

No.	Revisions	Date	By/Par

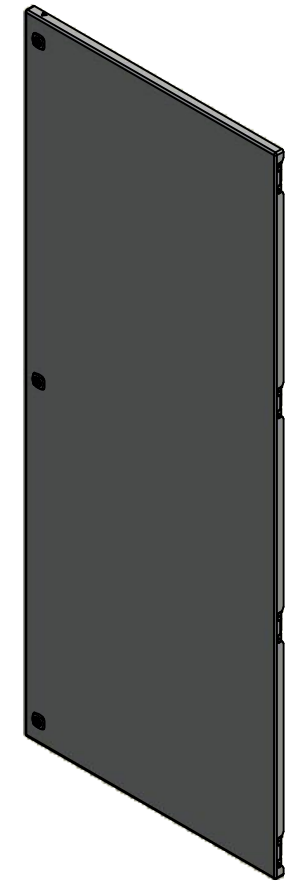

Isometric View

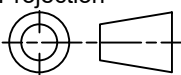

 Tél: (450) 979-4373 Fax: (450) 979-4626 www.exmweb.com	Flatness Aplatissement	Max 3.0mm
	Projection	
Customer Client	Date	
Drawn By Dessiné Par	BoxCad: BoxCad	Date 7/22/2022
Material Matière	14 Ga Cold Rolled A1008 CS Type B (1.7mm)	
Color Couleur	Light Grey RAL7035	Finish Fini Rough Textured
Description	Detail Rev.	
6500WDFD 1600mm x 400mm Top Cover		
Part Number Numéro Pièce	Rev.	9
6500WDFD1604TD	0	9

Qty	Part Number	Rev	Description
2	STK-Q-16080	0	Ground Stud M6 x 16mm
1	STK-P-03820R	0	Powder Paint (Light Grey / Rough Textured)
2	STK-Q-46020-12	5	5412 ES Vertical Door Stiffener 12"
4	STK-Q-16055	1	M6 x 18mm Stud (No Paint Cap Required)
1	6500WDFD1604TD-P	0	6500WDFD 1600mm x 400mm Top Cover Part
1	6500WDFD1604TD-G	0	6500WDFD 200mm x 1600mm Top Cover Gasket
4	STK-K-09800	10	5412 ES Hinge with 2 Captive Hinge Pins
4	STK-Q-07220	1	M6 Nylon Insert Lock Nut
3	880 SCQ4-SL	6	5412 ES 1/4 Turn Lock
Parts List			