

This drawing is confidential and must not be reproduced or used without the consent of EXM

Ce dessin est confidentiel et ne doit pas être reproduit ou utilisé sans le consentement de EXM

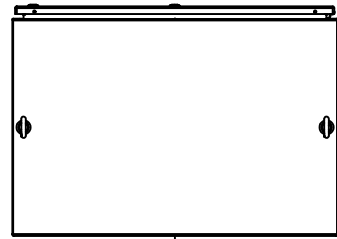

TOP

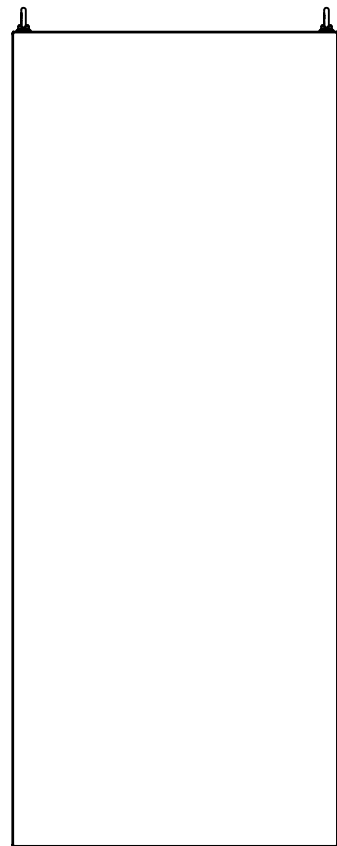

BACK

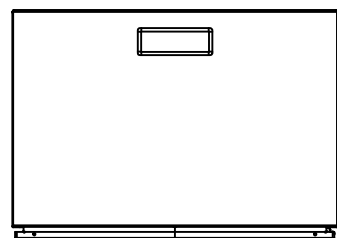

BOTTOM

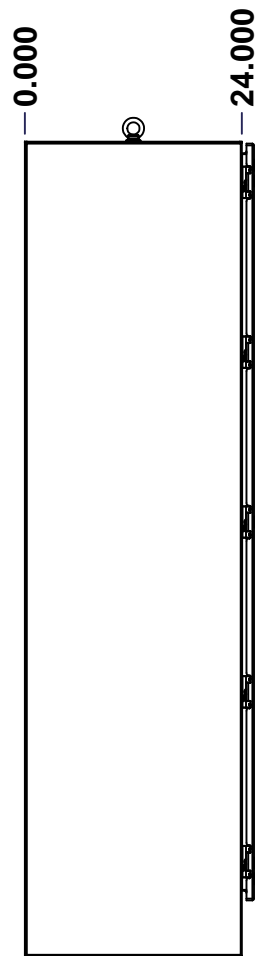

LEFT

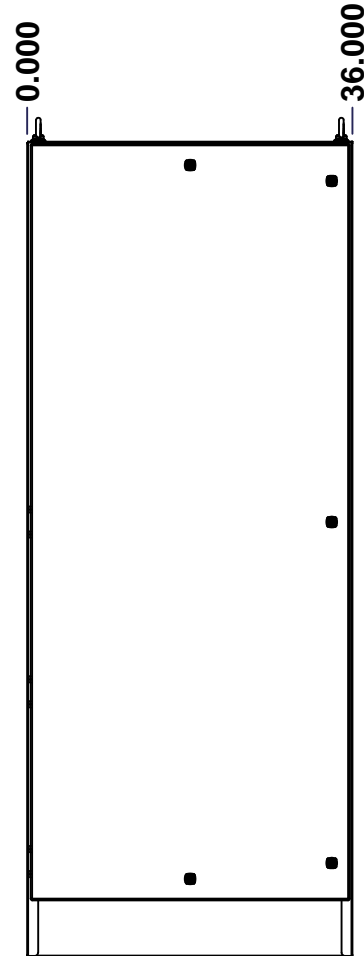

FRONT

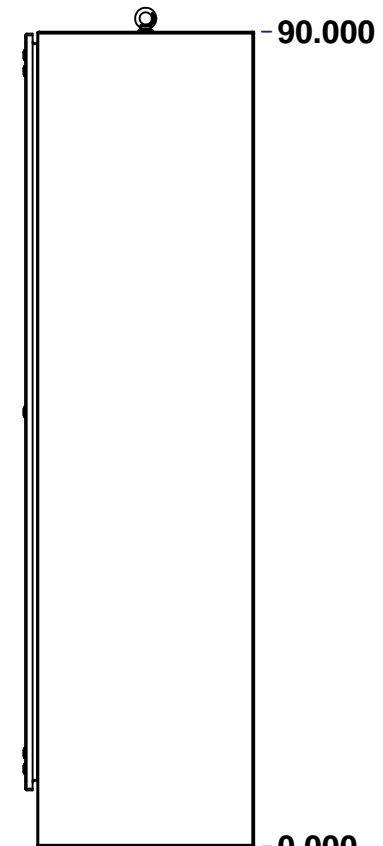

RIGHT

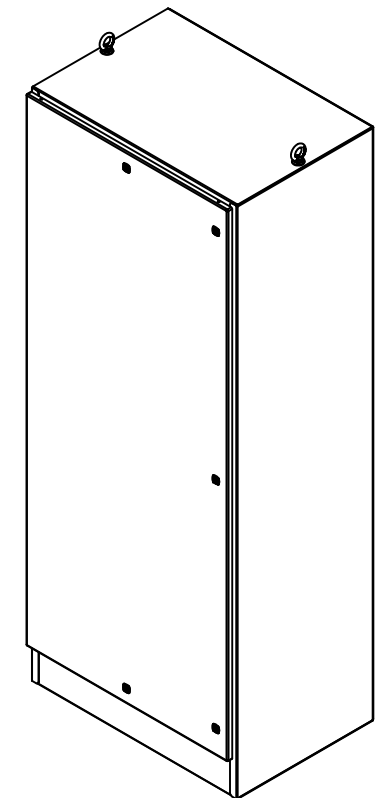

Isometric View

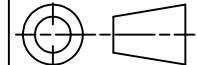

No.	Revisions	Date	By/Par

 Tél: (450) 979-4373 Fax: (450) 979-4626 <a href="http://www.exmweb.com">www.exmweb.com</a>		Flatness Aplatissement Max 3.0mm Projection 
Customer Client	Date	
Drawn By Dessiné Par	BoxCad: BoxCad	Date 07-Oct-19
Material Matière	12 Ga Cold Rolled A1008 CS Type B (2.5mm)	
Color Couleur	Asa-61 Grey	Finish Fini Smooth
Description	Detail Rev.	
9412 90" x 36" x 24" Assembly		
Part Number Numéro Pièce	Rev. 0	1 2

SEE BILL OF MATERIAL ON LAST PAGE

**9412903624**

This drawing is confidential and must not be reproduced or used without the consent of EXM

Ce dessin est confidentiel et ne doit pas être reproduit ou utilisé sans le consentement de EXM

NOTE	
ITEM	DESCRIPTION
1	NEMA 4/12 Enclosure
2	C/W Standard ground studs on box and cover
3	W/O Standard door stiffener
4	W/O Inner panel
5	C/W Standard inner panel mounting struts
6	C/W Eyebolts
7	C/W Struts installed (Included)

No.	Revisions	Date	By/Par

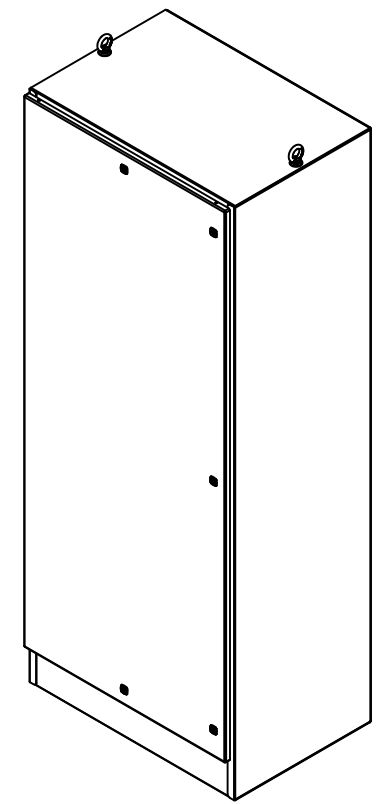

Isometric View

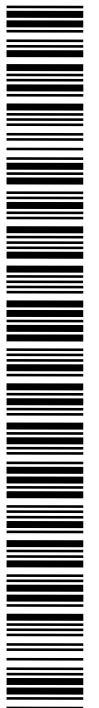

PACKING		
ITEM	QTY	DESCRIPTION
Cardboard sleeve	2	Top and Bottom
Cardboard strip	2	Between back of enclosure and inner panel
Plastic bag	1	To protect cover surface and inside gasket
Cardboard corner	4	To reinforced for the plastic strap tightening
Plastic strap - Black	2	To Squeeze 2 cardboard sleeve together
Packaging label	3	White label with PN
Plastic strap- Green	2	To secure the enclosure to the wood pallet
Wood Pallet	1	2" deeper and 3" larger than enclosure size

Qty	Part Number	Rev	Description
1	9412903624GP	0	9412 Gland Plate
1	880EB14	2	Eye Bolt M14 (Pack of 2)
1	9412903624C	0	9412 90" x 36" Cover
1	9412903624B	0	9412 90" x 36" x 24" Body
5	STK-Q-04050-10	8	M6 x 10mm Hexagon Socket Head Machine Screw with Nyseal
Parts List			

		Tél: (450) 979-4373 Fax: (450) 979-4626 <a href="http://www.exmweb.com">www.exmweb.com</a>		Flatness Aplatissement Max 3.0mm	
Customer Client		Date		Projection	
Drawn By Dessiné Par		BoxCad: BoxCad		Date 07-Oct-19	
Material Matière		12 Ga Cold Rolled A1008 CS Type B (2.5mm)			
Color Couleur		Asa-61 Grey		Finish Fini Smooth	
Description 9412 90" x 36" x 24" Assembly				Detail Rev.	
Part Number Numéro Pièce				Rev. 2	
<b>9412903624</b>				<b>0</b>	

This drawing is confidential and must not be reproduced or used without the consent of EXM

Ce dessin est confidentiel et ne doit pas être reproduit ou utilisé sans le consentement de EXM

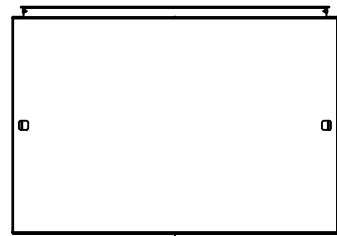

TOP

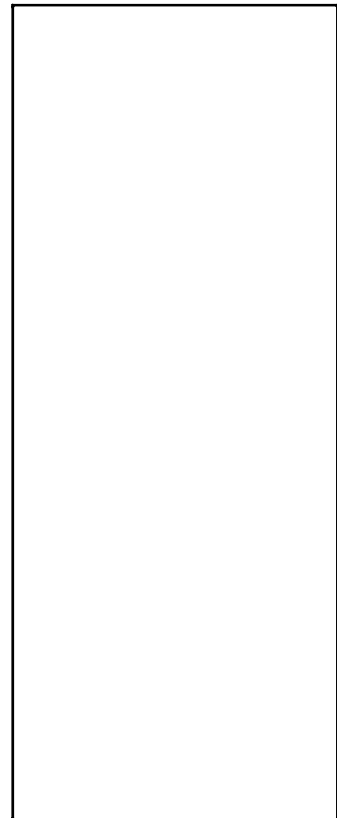

BACK

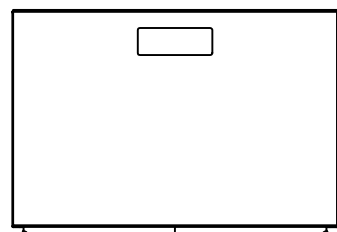

BOTTOM

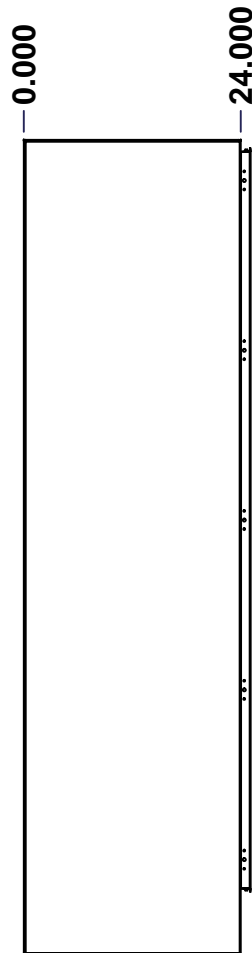

LEFT

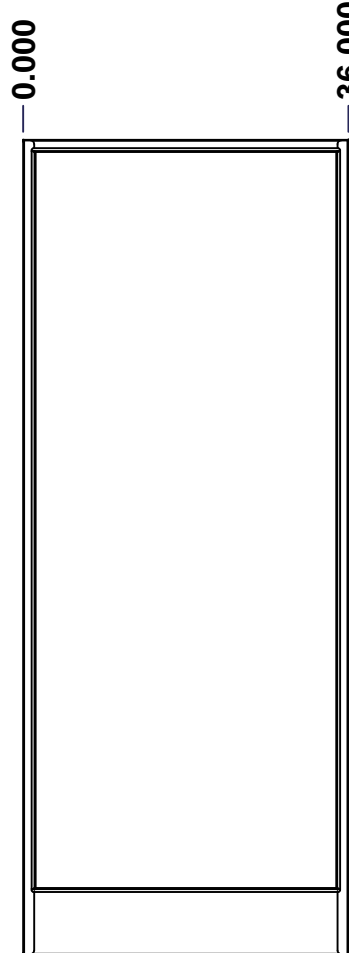

FRONT

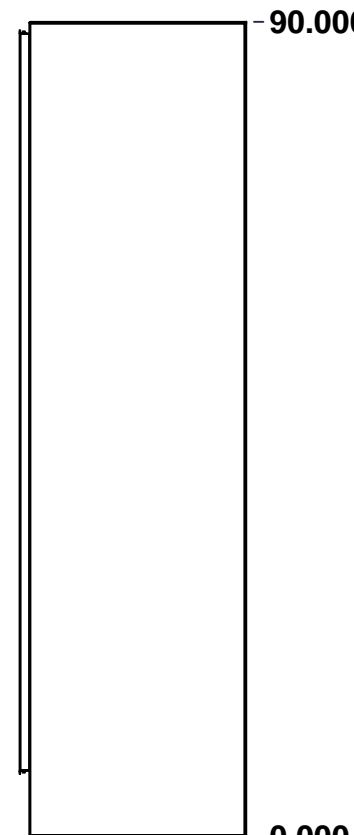

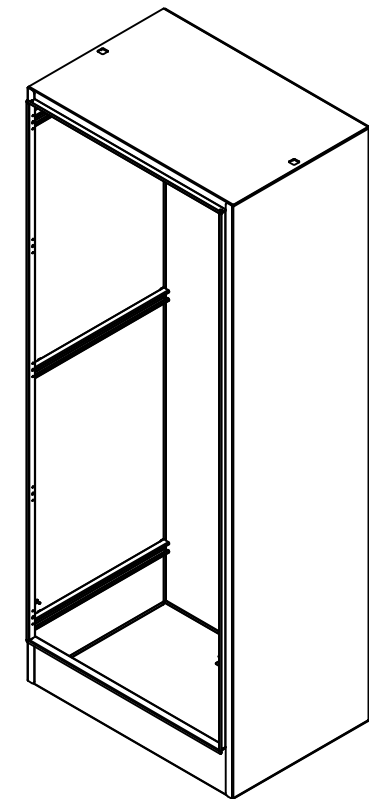

RIGHT



Isometric View

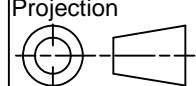

No.	Revisions	Date	By/Par

 Tél: (450) 979-4373 Fax: (450) 979-4626 <a href="http://www.exmweb.com">www.exmweb.com</a>		Flatness Aplatissement  Max 3.0mm Projection 
Customer Client	Date	
Drawn By / Dessiné Par: BoxCad: BoxCad	Date: 07-Oct-19	
Material / Matière: 12 Ga Cold Rolled A1008 CS Type B (2.5mm)		
Color / Couleur: Asa-61 Grey	Finish / Fini: Smooth	
Description: 9412 90" x 36" x 24" Body		Detail Rev.
Part Number / Numéro Pièce: 9412903624B		Rev. 1/2

SEE BILL OF MATERIAL ON LAST PAGE

This drawing is confidential and must not be reproduced or used without the consent of EXM

Ce dessin est confidentiel et ne doit pas être reproduit ou utilisé sans le consentement de EXM

**STANDARD FEATURES ARE NOT LISTED IN THIS HOLE TABLE**

**HOLE TABLE - TOP VIEW (CUSTOM FEATURE ONLY)**

CUT-OUT	XDIM	YDIM	DESCRIPTION
1	17.911	19.911	Struts CR400 27.500" (Inside)
2	17.911	19.911	STUDS M6 x 10mm (Inside)
3	7.161	19.911	STUDS M6 x 10mm (Inside)
4	28.661	19.911	STUDS M6 x 10mm (Inside)

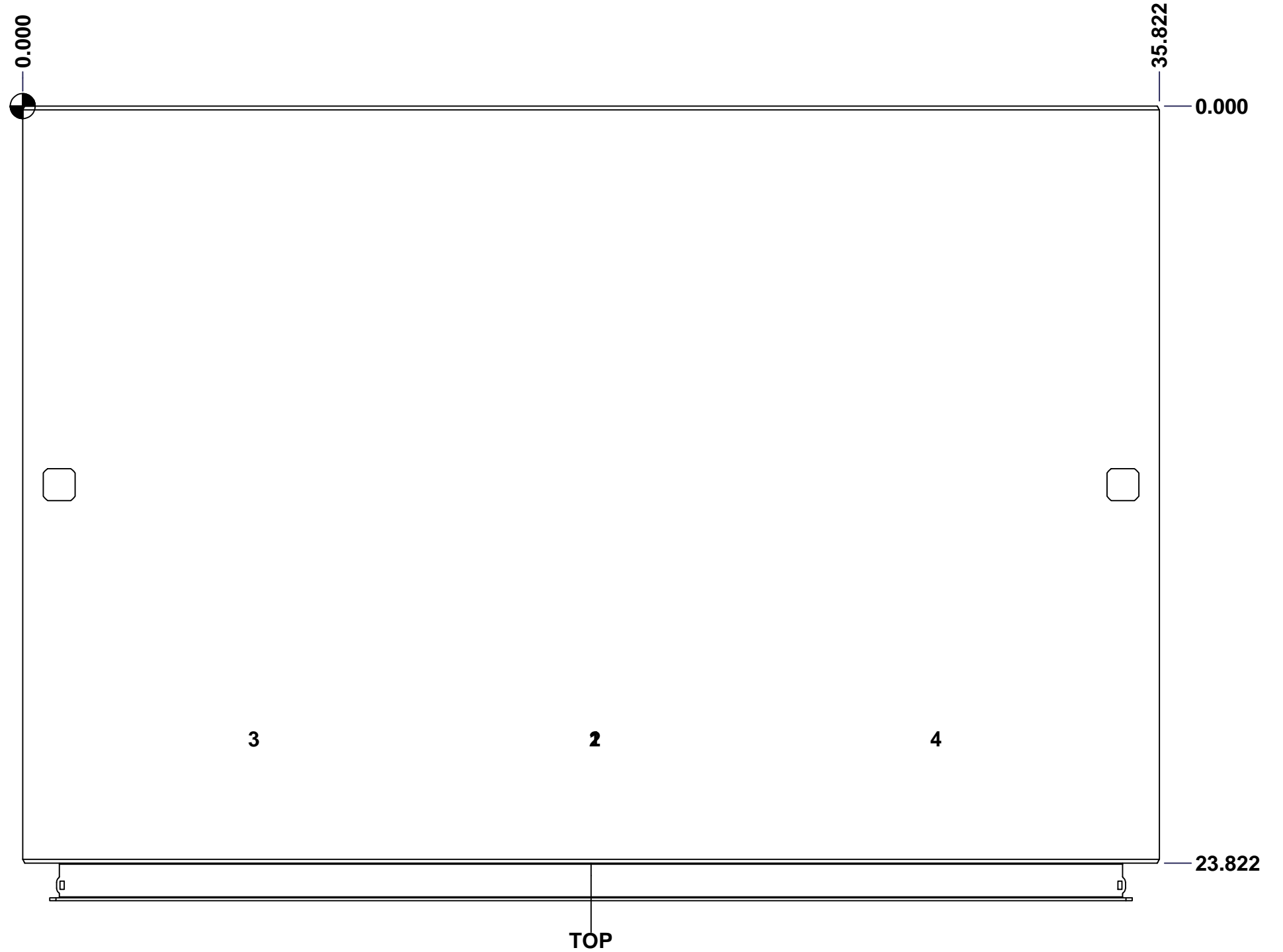

	Description 9412 90" x 36" x 24" Body	Status Released
	Part Number Numéro Pièce <b>9412903624B</b>	Rev. 2 <b>0</b> / 7

This drawing is confidential and must not be reproduced or used without the consent of EXM

Ce dessin est confidentiel et ne doit pas être reproduit ou utilisé sans le consentement de EXM

**STANDARD FEATURES ARE NOT LISTED IN THIS HOLE TABLE**

**HOLE TABLE - RIGHT VIEW (CUSTOM FEATURE ONLY)**

CUT-OUT	XDIM	YDIM	DESCRIPTION
1	3.161	85.036	STUDS M6 x 10mm (Inside)
2	20.661	85.036	STUDS M6 x 10mm (Inside)
3	11.911	85.036	STUDS M6 x 10mm (Inside)
4	3.161	8.786	STUDS M6 x 10mm (Inside)
5	20.661	8.786	STUDS M6 x 10mm (Inside)
6	11.911	8.786	STUDS M6 x 10mm (Inside)
7	3.161	46.911	STUDS M6 x 10mm (Inside)
8	20.661	46.911	STUDS M6 x 10mm (Inside)
9	11.911	46.911	STUDS M6 x 10mm (Inside)

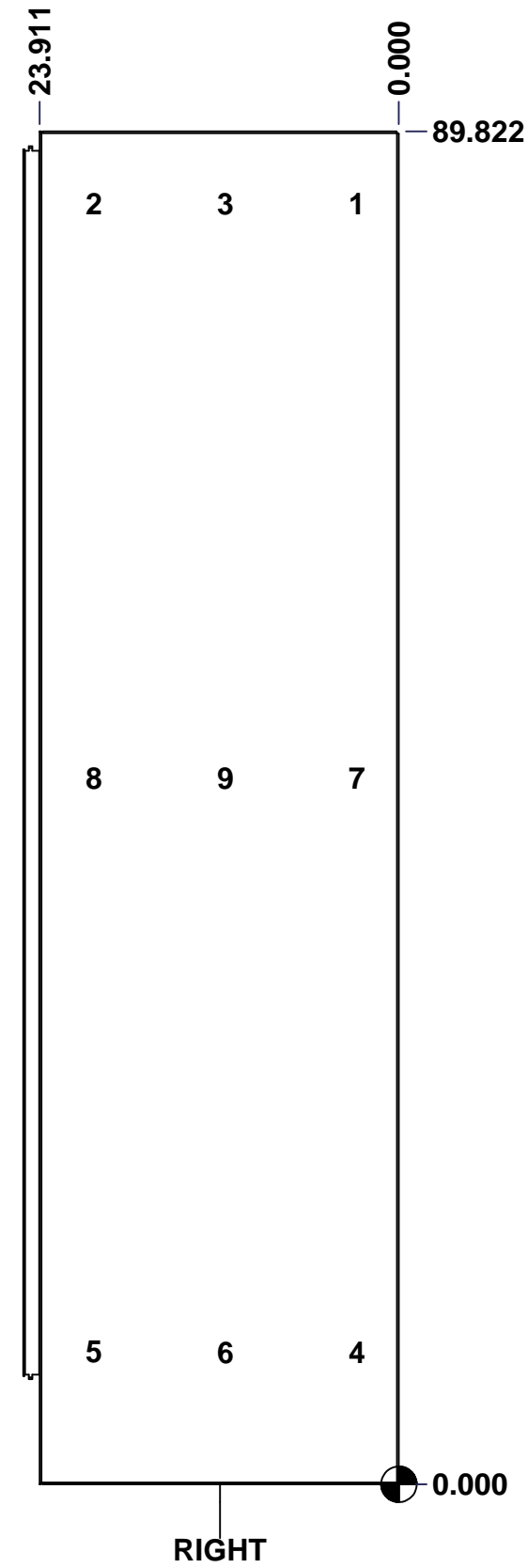

	Description	Status
	9412 90" x 36" x 24" Body	Released
	Part Number Numéro Pièce	Rev.
	<b>9412903624B</b>	<b>0</b>
		3
		7

This drawing is confidential and must not be reproduced or used without the consent of EXM

Ce dessin est confidentiel et ne doit pas être reproduit ou utilisé sans le consentement de EXM

STANDARD FEATURES ARE NOT LISTED IN THIS HOLE TABLE			
HOLE TABLE - BOTTOM VIEW (CUSTOM FEATURE ONLY)			
CUT-OUT	XDIM	YDIM	DESCRIPTION
1	13.286	3.411	GP STUD M6 x 16mm (Inside)
2	22.536	3.411	GP STUD M6 x 16mm (Inside)

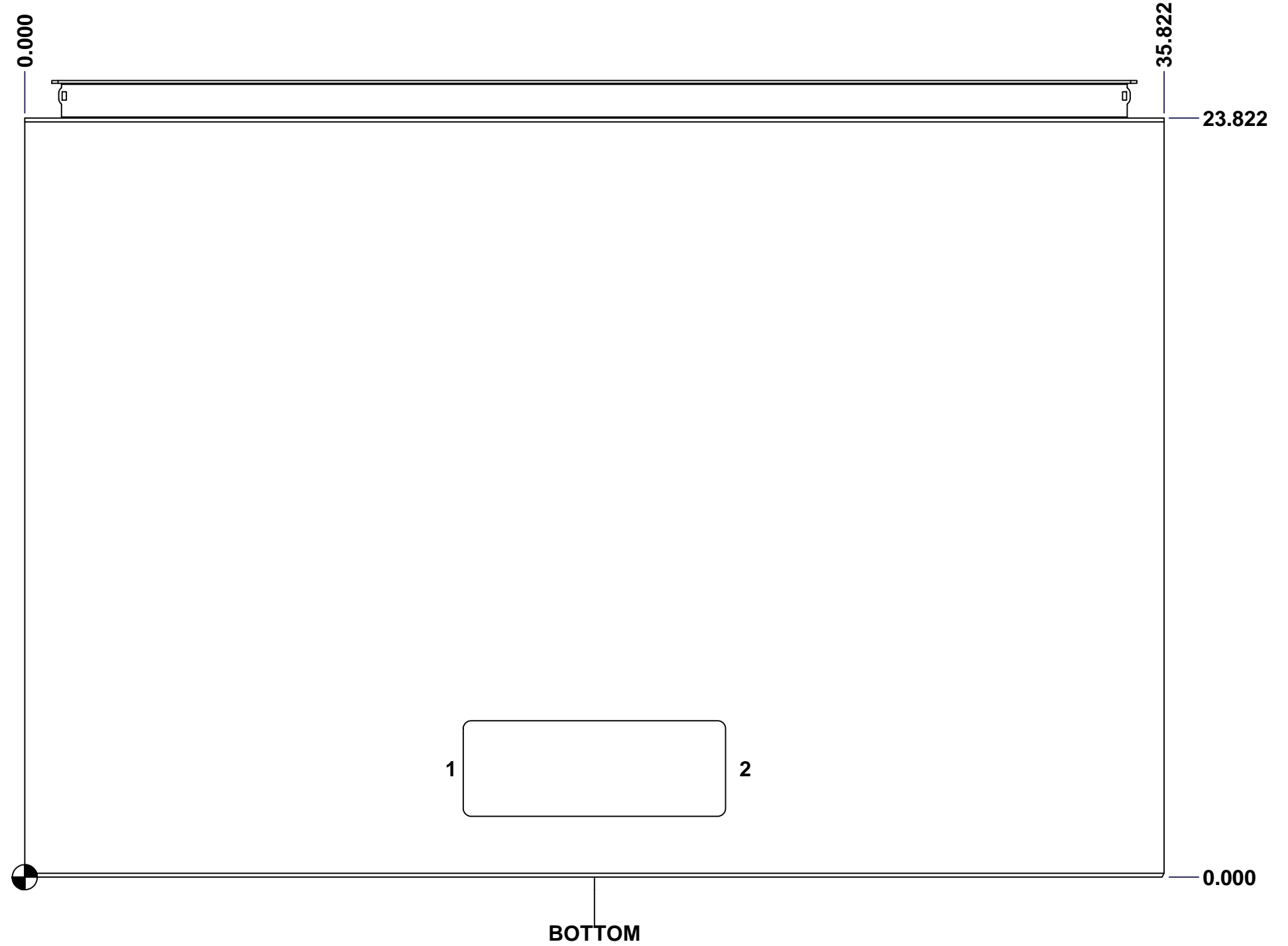

	Description	Status
	9412 90" x 36" x 24" Body	Released
	Part Number Numéro Pièce	Rev.
	<b>9412903624B</b>	<b>0</b>
		4 / 7

This drawing is confidential and must not be reproduced or used without the consent of EXM

Ce dessin est confidentiel et ne doit pas être reproduit ou utilisé sans le consentement de EXM

**STANDARD FEATURES ARE NOT LISTED IN THIS HOLE TABLE**

**HOLE TABLE - LEFT VIEW (CUSTOM FEATURE ONLY)**

CUT-OUT	XDIM	YDIM	DESCRIPTION
1	22.411	11.286	GND STUD M6 x 16mm (Inside)
2	3.161	85.036	STUDS M6 x 10mm (Inside)
3	20.661	85.036	STUDS M6 x 10mm (Inside)
4	11.911	85.036	STUDS M6 x 10mm (Inside)
5	3.161	8.786	STUDS M6 x 10mm (Inside)
6	20.661	8.786	STUDS M6 x 10mm (Inside)
7	11.911	8.786	STUDS M6 x 10mm (Inside)
8	3.161	46.911	STUDS M6 x 10mm (Inside)
9	20.661	46.911	STUDS M6 x 10mm (Inside)
10	11.911	46.911	STUDS M6 x 10mm (Inside)

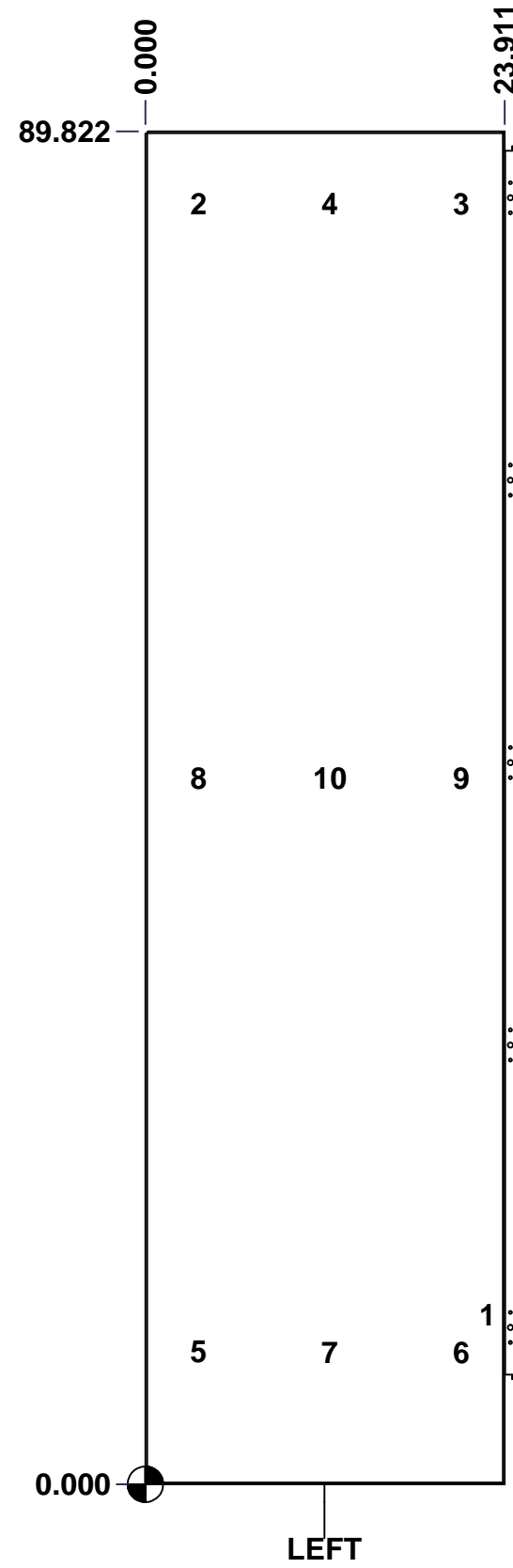

	Description	Status	
	9412 90" x 36" x 24" Body	Released	
	Part Number Numéro Pièce	Rev.	
	<b>9412903624B</b>	<b>0</b>	5 / 7

This drawing is confidential and must not be reproduced or used without the consent of EXM

Ce dessin est confidentiel et ne doit pas être reproduit ou utilisé sans le consentement de EXM

No.	Revisions	Date	By/Par

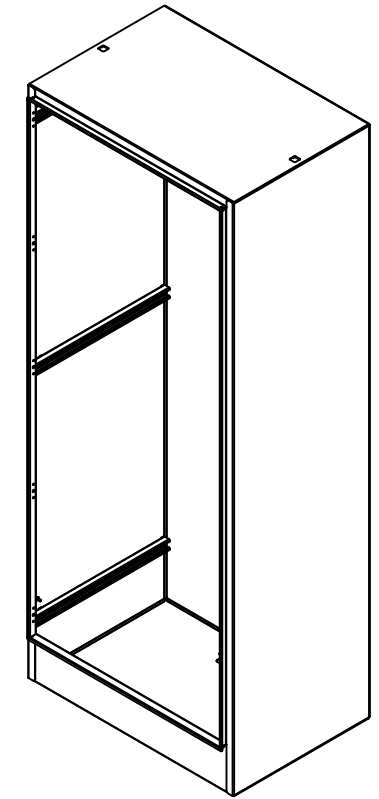

Isometric View



21	STK-Q-16030	0	Stud M6 x 10mm
1	CR400MS_27.5	0	Commercial Roll Mild Steel (27.5in long)
1	STK-P-02400S	0	Powder Paint (Asa-61 Grey / Smooth)
3	STK-Q-52200-24	2	Sasco Strut S5 (21.500" Long)
3	STK-Q-52250-24	2	Sasco Strut S5 (23.500" Long)
1	9412903624BT-P	0	9412 36" x 24" Bottom Part
1	9412903624T-P	0	9412 36" x 24" Top Part
1	9412903624RS-P	0	9412 90" x 36" Right Part
1	9412903624LS-P	0	9412 90" x 36" Left Part
1	9412903624B-P	0	9412 90" x 36" Back Part
21	STK-Q-07220	1	M6 Nylon Insert Lock Nut
3	STK-Q-16080	0	Ground Stud M6 x 16mm
Qty	Part Number	Rev	Description
Parts List			



Tél: (450) 979-4373  
Fax: (450) 979-4626  
[www.exmweb.com](http://www.exmweb.com)

Flatness  
Aplatissement  
Max 3.0mm

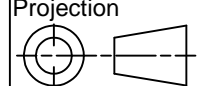
Projection  

---

Customer Client	Date
Drawn By Dessiné Par BoxCad: BoxCad	Date 07-Oct-19
Material Matière 12 Ga Cold Rolled A1008 CS Type B (2.5mm)	
Color Couleur Asa-61 Grey	Finish Fini Smooth
Description 9412 90" x 36" x 24" Body	Detail Rev.
Part Number Numéro Pièce <b>9412903624B</b>	Rev. <b>0</b>



This drawing is confidential and must not be reproduced or used without the consent of EXM

Ce dessin est confidentiel et ne doit pas être reproduit ou utilisé sans le consentement de EXM

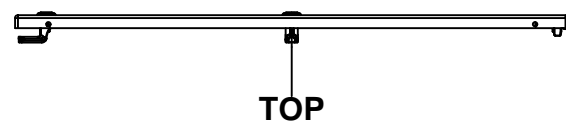

TOP

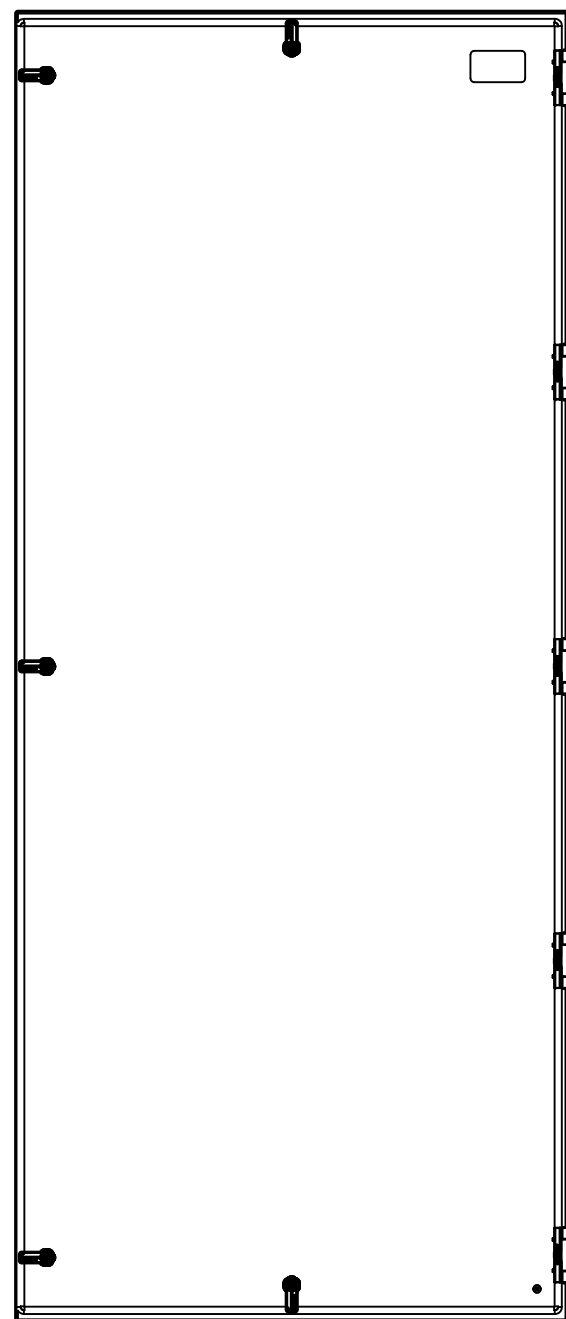

BACK

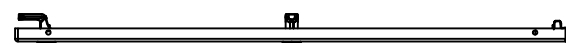

BOTTOM

0.000  
0.835

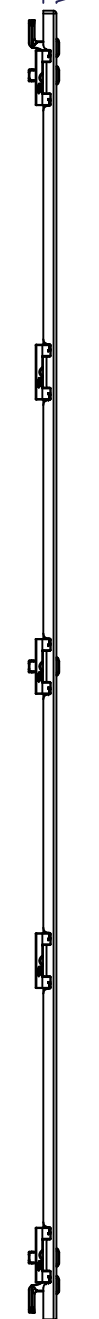

LEFT

0.000  
35.312

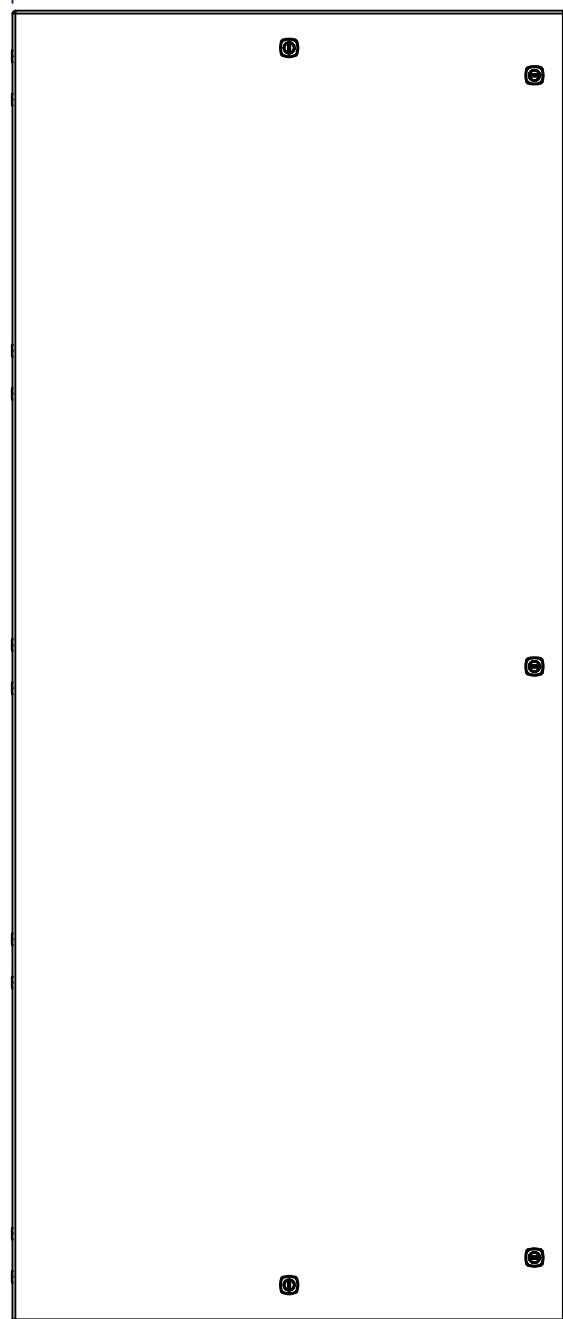

FRONT

83.549



RIGHT

0.000

No.	Revisions	Date	By/Par

Isometric View

<p>Tél: (450) 979-4373 Fax: (450) 979-4626 <a href="http://www.exmweb.com">www.exmweb.com</a></p>		Flatness Aplatissement	
		Max 3.0mm	
Customer Client		Projection	
Date			
Drawn By Dessiné Par BoxCad: BoxCad		Date 07-Oct-19	
Material Matière 12 Ga Cold Rolled A1008 CS Type B (2.5mm)			
Color Couleur Asa-61 Grey		Finish Fini Smooth	
Description 9412 90" x 36" Cover		Detail Rev.	
Part Number Numéro Pièce <b>9412903624C</b>		Rev. <b>0</b>	1 3

SEE BILL OF MATERIAL ON LAST PAGE

This drawing is confidential and must not be reproduced or used without the consent of EXM

Ce dessin est confidentiel et ne doit pas être reproduit ou utilisé sans le consentement de EXM

**STANDARD FEATURES ARE NOT LISTED IN THIS HOLE TABLE**

**HOLE TABLE - FRONT VIEW (CUSTOM FEATURE ONLY)**

CUT-OUT	XDIM	YDIM	DESCRIPTION
1	33.312	79.430	LOCK 889 SCQ4-SL @ 0.0°
2	17.656	2.368	LOCK 889 SCQ4-SL @ 270.0°
3	33.312	41.774	LOCK 889 SCQ4-SL @ 0.0°
4	33.312	4.118	LOCK 889 SCQ4-SL @ 0.0°
5	17.656	81.180	LOCK 889 SCQ4-SL @ 90.0°
6	2.000	2.118	GND STUD M6 x 16mm (Inside)

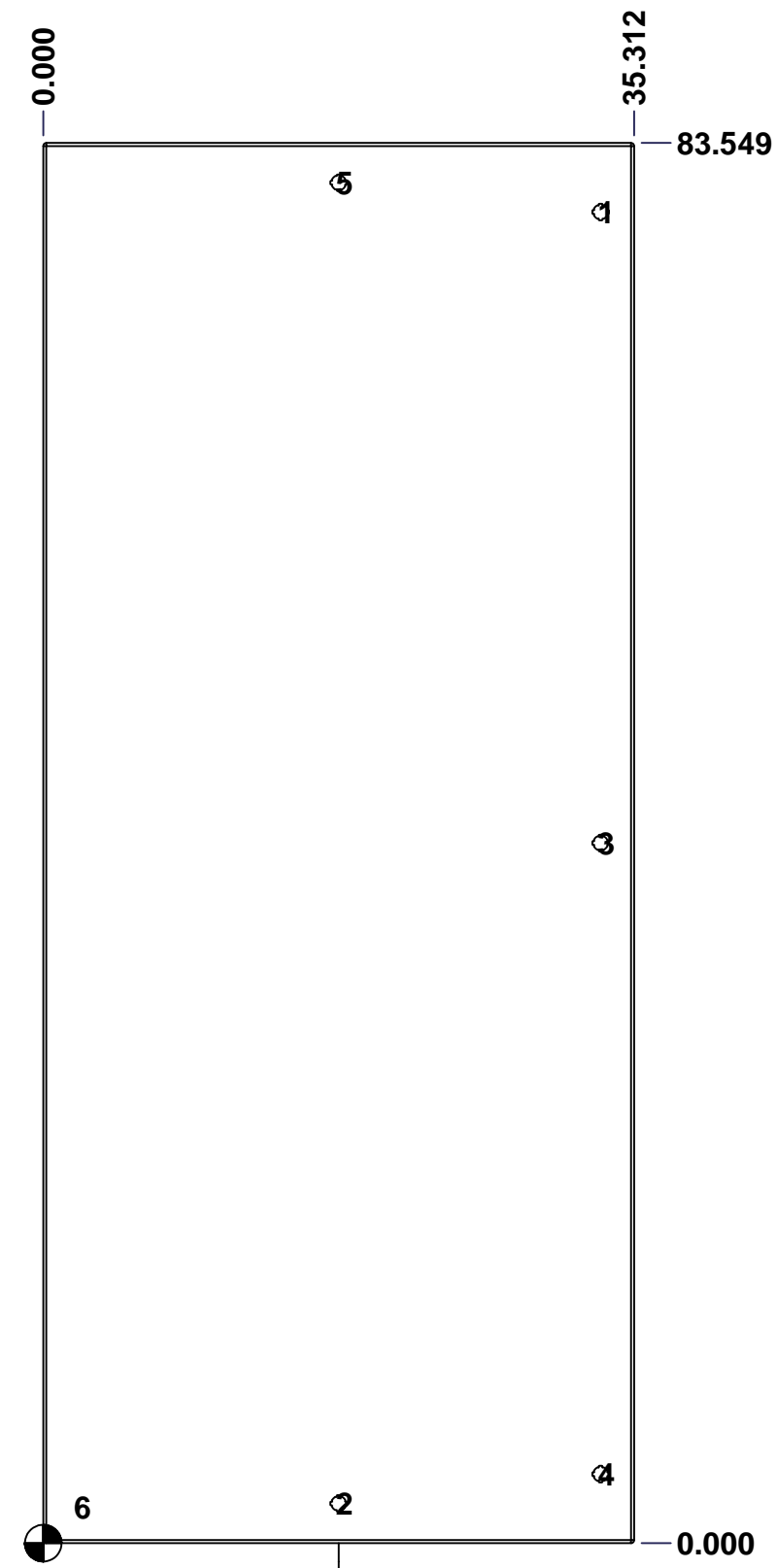

FRONT

	Description	Status
	9412 90" x 36" Cover	(NULL)
	Part Number Numéro Pièce	Rev.
	<b>9412903624C</b>	<b>0</b>
		2
		3

This drawing is confidential and must not be reproduced or used without the consent of EXM

Ce dessin est confidentiel et ne doit pas être reproduit ou utilisé sans le consentement de EXM

No.	Revisions	Date	By/Par

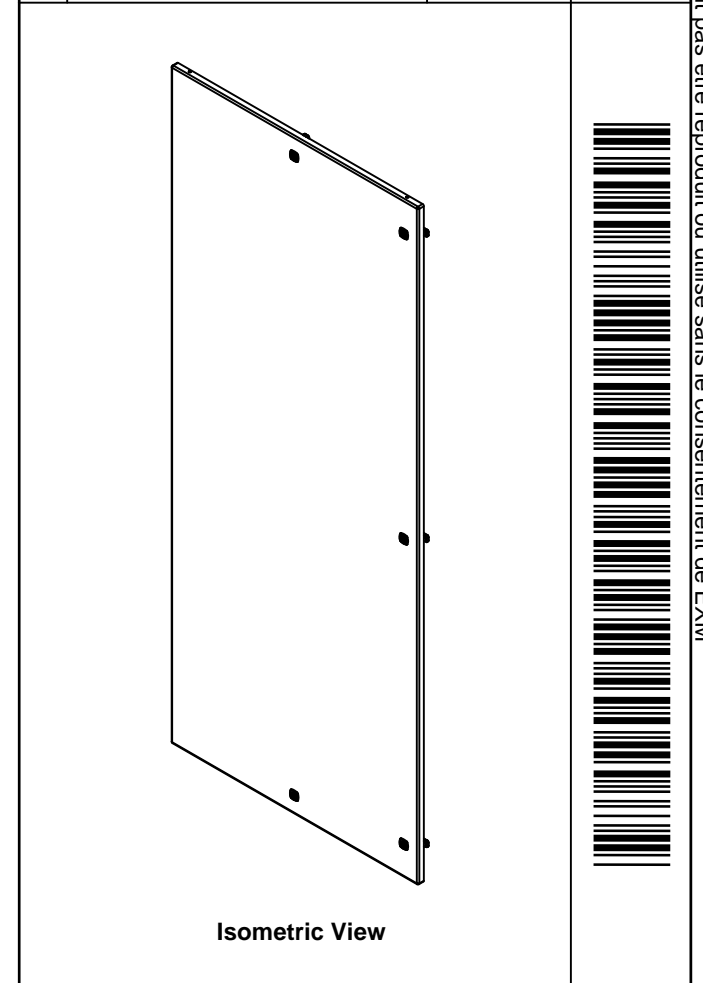

Tél: (450) 979-4373 Fax: (450) 979-4626 <a href="http://www.exmweb.com">www.exmweb.com</a>		Flatness Aplatissement	
		Max 3.0mm Projection	
Customer Client		Date	
Drawn By Dessiné Par		Date	
BoxCad: BoxCad		07-Oct-19	
Material Matière			
12 Ga Cold Rolled A1008 CS Type B (2.5mm)			
Color Couleur		Finish Fini	
Asa-61 Grey		Smooth	
Description			Detail Rev.
9412 90" x 36" Cover			
Part Number Numéro Pièce		Rev.	3
<b>9412903624C</b>		<b>0</b>	<b>3</b>

1	STK-Q-16080	0	Ground Stud M6 x 16mm
1	9412903624G	0	9412 90" x 36" Cover Gasket
1	STK-P-02400S	0	Powder Paint (Asa-61 Grey / Smooth)
1	STK-S-00100	0	3.5" x 2" Silver Milar Flexcon Sticker
1	9412903624C-P	0	9412 90" x 36" Cover Part
5	STK-K-09860	7	Cabinet Hinge with Captive Pins
5	STK-K-12580	0	9412 1/4 Turn Lock
Qty	Part Name	Rev	Description
Parts List			

All knockouts are actual size / Les disques défonçables sont grandeur réel  
 All dimensions are before paint / Toutes les dimensions sont avant peinture

This drawing is confidential and must not be reproduced or used without the consent of EXM

Ce dessin est confidentiel et ne doit pas être reproduit ou utilisé sans le consentement de EXM

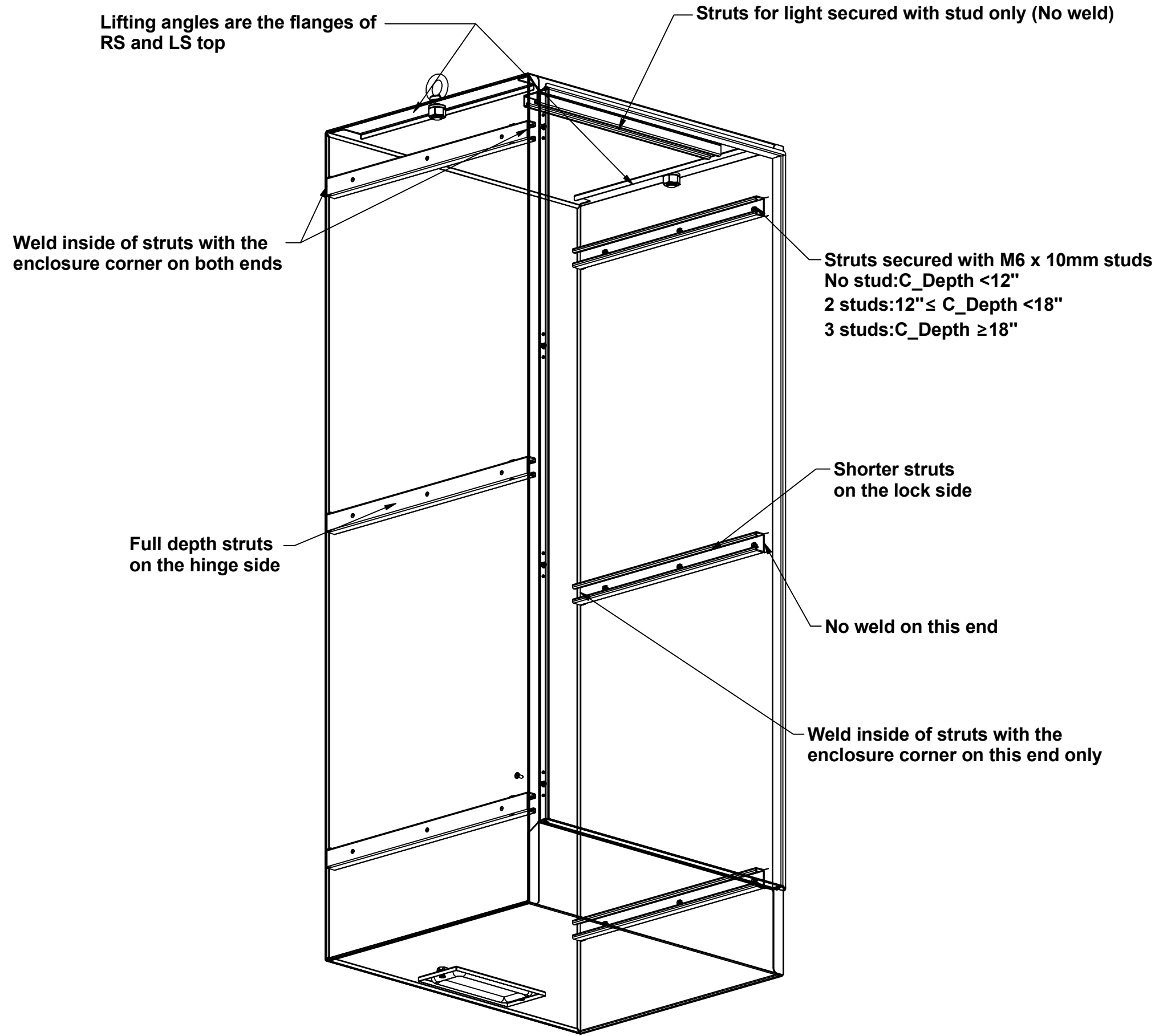

No.	Revisions	Date	By/Par

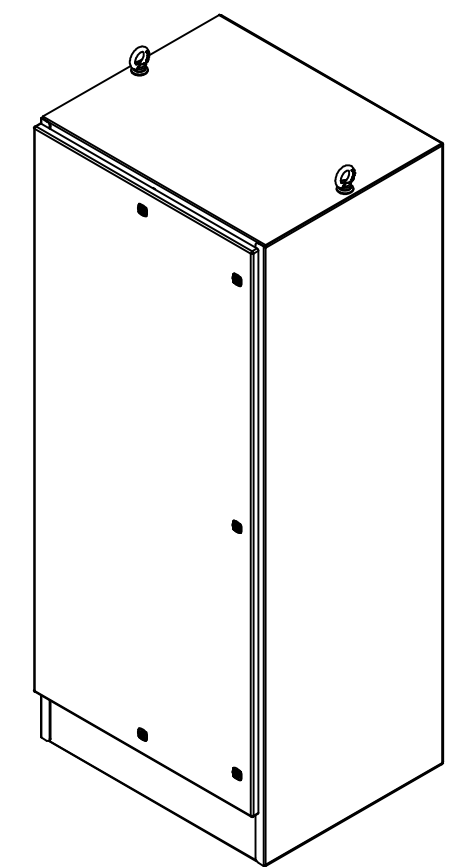

Isometric View



Tél: (450) 979-4373  
 Fax: (450) 979-4626  
[www.exmweb.com](http://www.exmweb.com)

Flatness  
 Aplatissement  
 Max 3.0mm  
 Projection

Customer Client	Date
Drawn By / Dessiné Par: PatrickD	Date: 3/9/2020
Material / Matière: N/A	
Color / Couleur: N/A	Finish / Fini: N/A
Description: 9412 Welding Detail	Detail Rev.
Part Number / Numéro Pièce: 9412_WELDING_DETAIL	Rev. 0

1  
1