

This drawing is confidential and must not be reproduced or used without the consent of EXM

Ce dessin est confidentiel et ne doit pas être reproduit ou utilisé sans le consentement de EXM

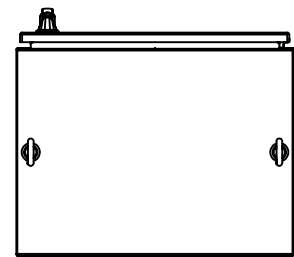

TOP

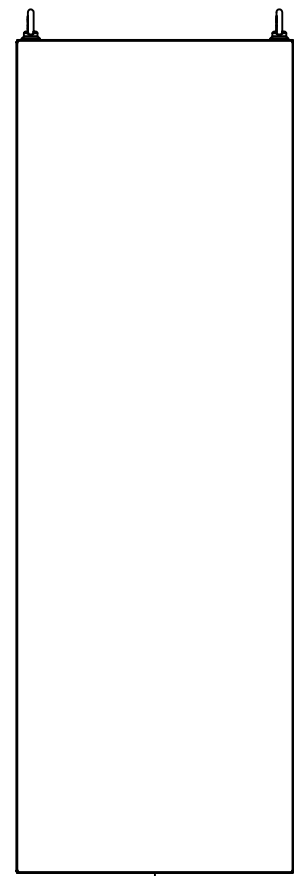

BACK

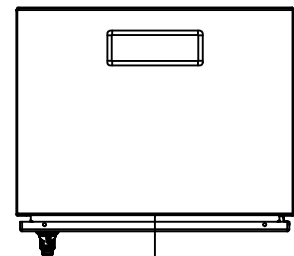

BOTTOM

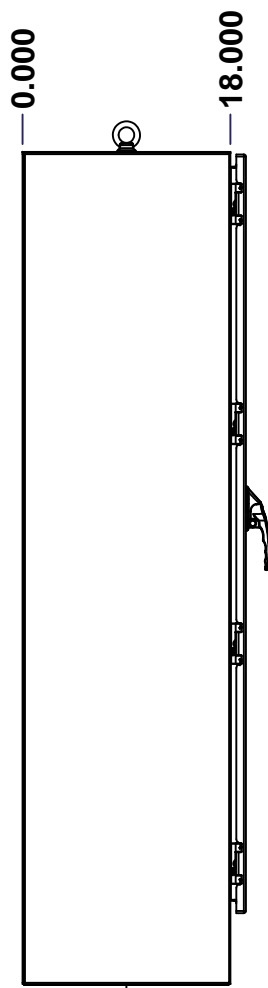

LEFT

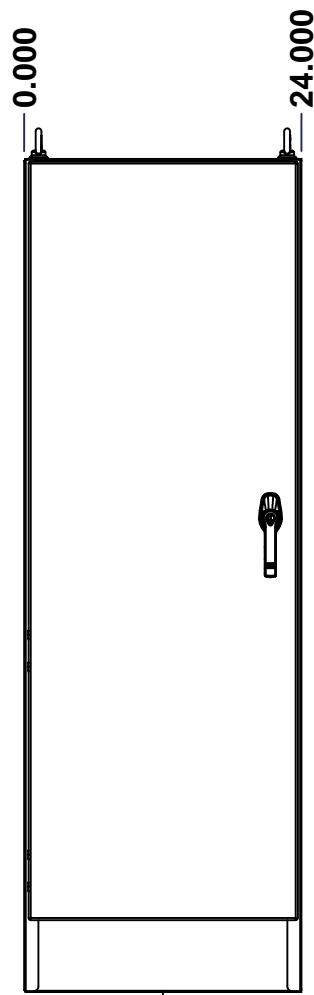

FRONT

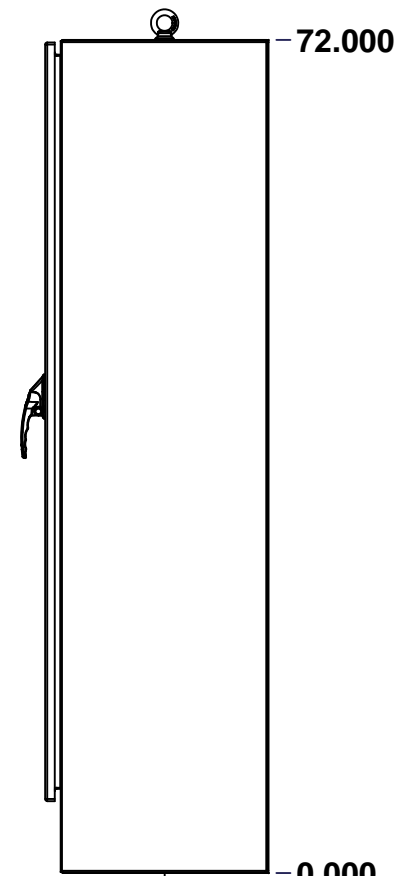

RIGHT

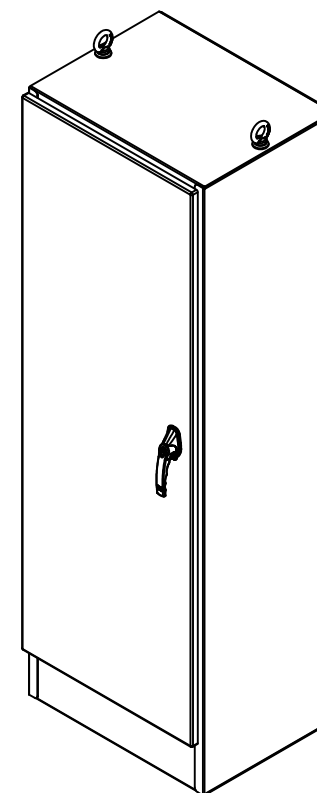

Isometric View

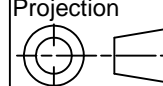

No.	Revisions	Date	By/Par

 Tél: (450) 979-4373 Fax: (450) 979-4626 www.exmweb.com		Flatness Aplatissement Max 3.0mm Projection 
Customer Client	Date	
Drawn By / Dessiné Par: BoxCad: BoxCad	Date: 11-Sep-14	
Material / Matière: 12 Ga Cold Rolled A1008 CS Type B (2.5mm)		
Color / Couleur: Asa-61 Grey	Finish / Fini: Smooth	
Description: 9500 72" x 24" x 18" Assembly	Detail Rev.	
Part Number / Numéro Pièce: 9500722418	Rev. 0	1 / 2

SEE BILL OF MATERIAL ON LAST PAGE

This drawing is confidential and must not be reproduced or used without the consent of EXM

Ce dessin est confidentiel et ne doit pas être reproduit ou utilisé sans le consentement de EXM

NOTE	
ITEM	DESCRIPTION
1	NEMA 12/13 Enclosure
2	C/W Standard ground studs on box and cover
3	C/W Standard door stiffener
4	W/O Inner panel
5	C/W Standard inner panel mounting struts
6	C/W Eyebolts
7	C/W Struts installed (Included)

No.	Revisions	Date	By/Par

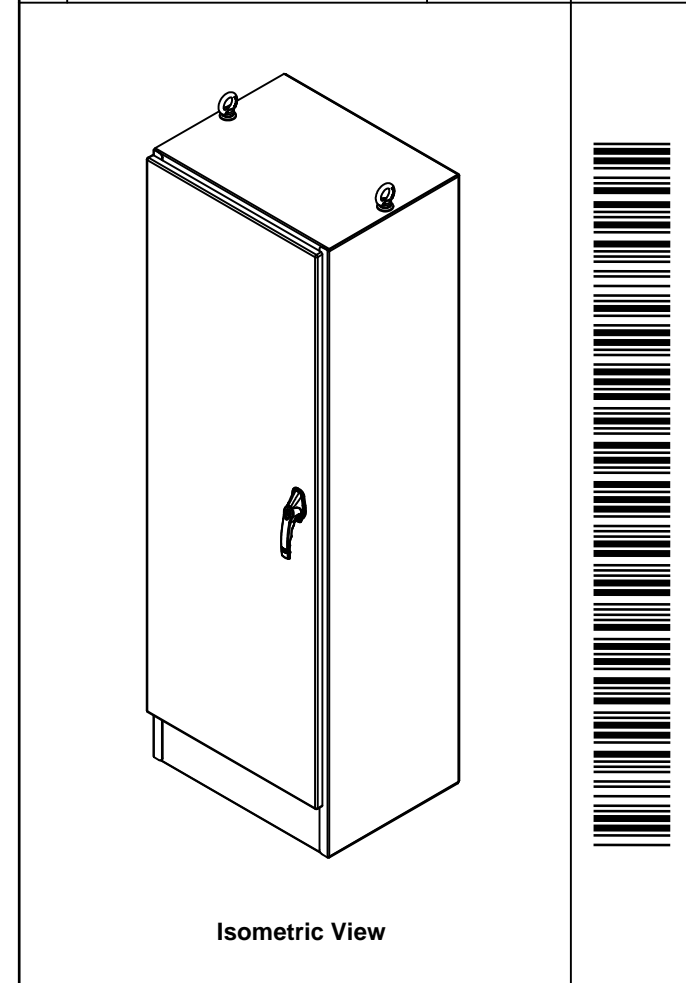

PACKING		
ITEM	QTY	DESCRIPTION
Cardboard sleeve	2	Top and Bottom
Cardboard strip	2	Between back of enclosure and inner panel
Plastic bag	1	To protect cover surface and inside gasket
Cardboard corner	4	To reinforced for the plastic strap tightening
Plastic strap - Black	2	To Squeeze 2 cardboard sleeve together
Packaging label	3	White label with PN
Plastic strap- Green	2	To secure the enclosure to the wood pallet
Wood Pallet	1	2" deeper and 3" larger than enclosure size

Qty	Part Number	Rev	Description
1	9500722418GP	0	9500 Gland Plate
1	880EB14	2	Eye Bolt M14 (Pack of 2)
1	9500722418C	0	9500 72" x 24" Cover
1	9500722418B	0	9500 72" x 24" x 18" Body
4	STK-Q-04050-10	8	M6 x 10mm Hexagon Socket Head Machine Screw with Nyseal
Parts List			

		Tél: (450) 979-4373 Fax: (450) 979-4626 www.exmweb.com		Flatness Aplatissement Max 3.0mm	
Projection 		Customer Client		Date	
Drawn By Dessiné Par		BoxCad: BoxCad		Date 11-Sep-14	
Material Matière		12 Ga Cold Rolled A1008 CS Type B (2.5mm)			
Color Couleur		Asa-61 Grey		Finish Fini Smooth	
Description 9500 72" x 24" x 18" Assembly				Detail Rev.	
Part Number Numéro Pièce				Rev. 2	
9500722418				0	

This drawing is confidential and must not be reproduced or used without the consent of EXM

Ce dessin est confidentiel et ne doit pas être reproduit ou utilisé sans le consentement de EXM

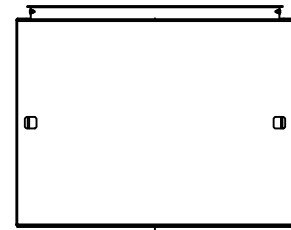

TOP

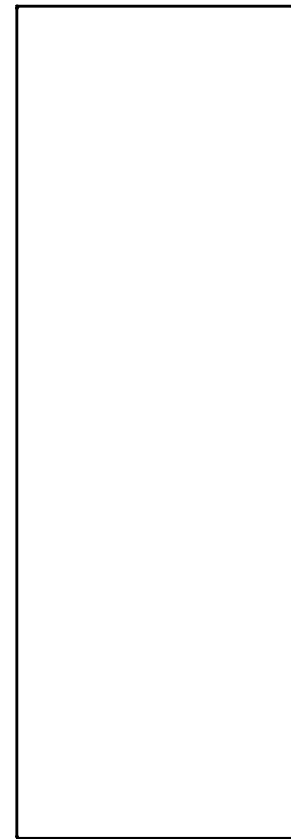

BACK

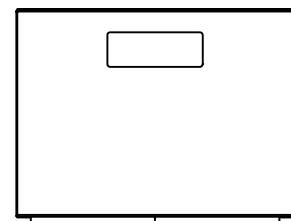

BOTTOM

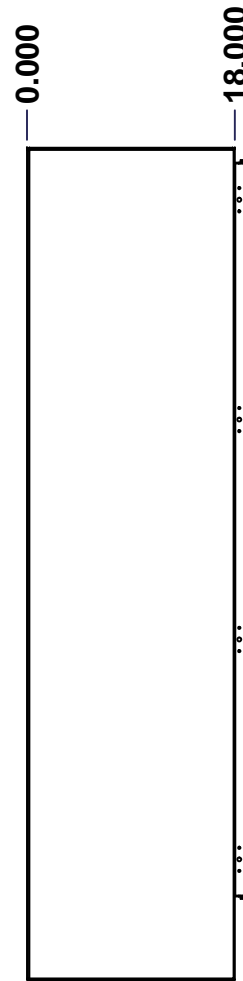

LEFT

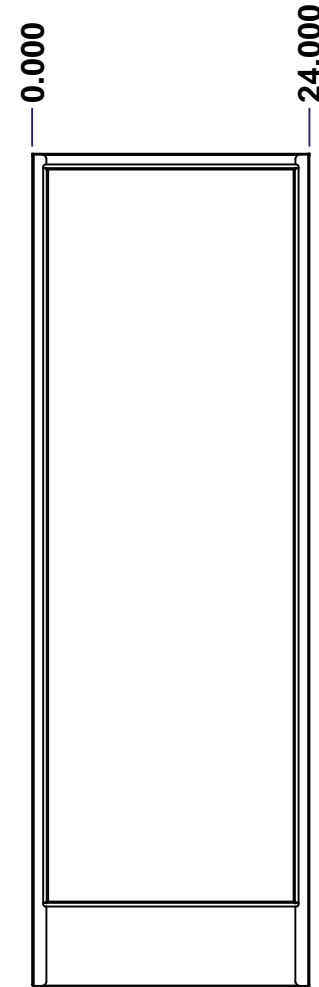

FRONT

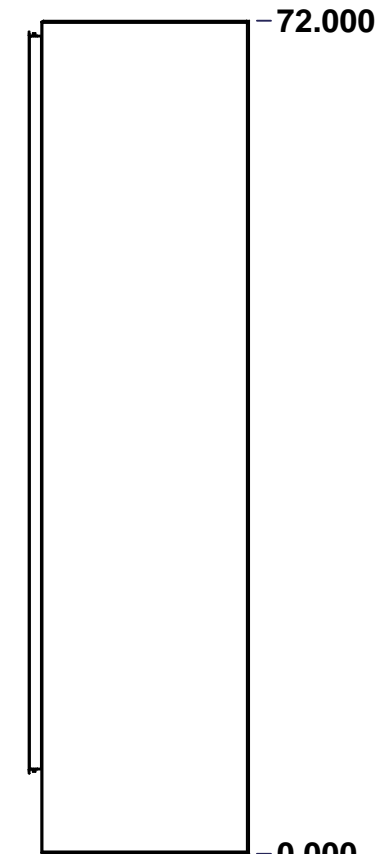

RIGHT

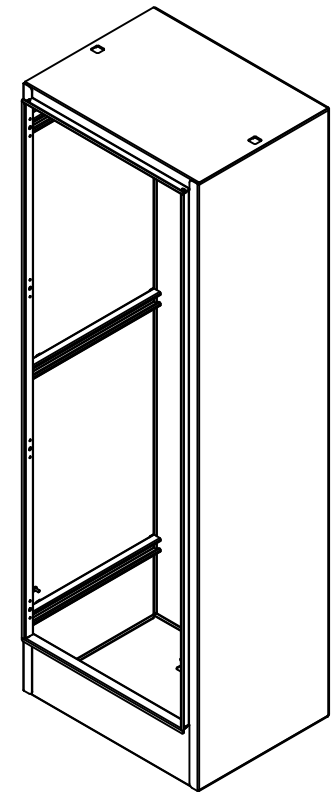

Isometric View

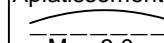
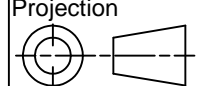

No.	Revisions	Date	By/Par

 Tél: (450) 979-4373 Fax: (450) 979-4626 www.exmweb.com		Flatness Aplatissement  Max 3.0mm Projection 
Customer Client	Date	
Drawn By Dessiné Par	BoxCad: BoxCad	Date 11-Sep-14
Material Matière	12 Ga Cold Rolled A1008 CS Type B (2.5mm)	
Color Couleur	Asa-61 Grey	Finish Fini Smooth
Description	Detail Rev.	
9500 72" x 24" x 18" Body		
Part Number Numéro Pièce	Rev. 0	1 2
9500722418B		

SEE BILL OF MATERIAL ON LAST PAGE

This drawing is confidential and must not be reproduced or used without the consent of EXM

Ce dessin est confidentiel et ne doit pas être reproduit ou utilisé sans le consentement de EXM

STANDARD FEATURES ARE NOT LISTED IN THIS HOLE TABLE

HOLE TABLE - TOP VIEW (CUSTOM FEATURE ONLY)

CUT-OUT	XDIM	YDIM	DESCRIPTION
1	11.911	13.911	Struts CR400 17.500" (Inside)
2	11.911	13.911	STUDS M6 x 10mm (Inside)
3	6.161	13.911	STUDS M6 x 10mm (Inside)
4	17.661	13.911	STUDS M6 x 10mm (Inside)

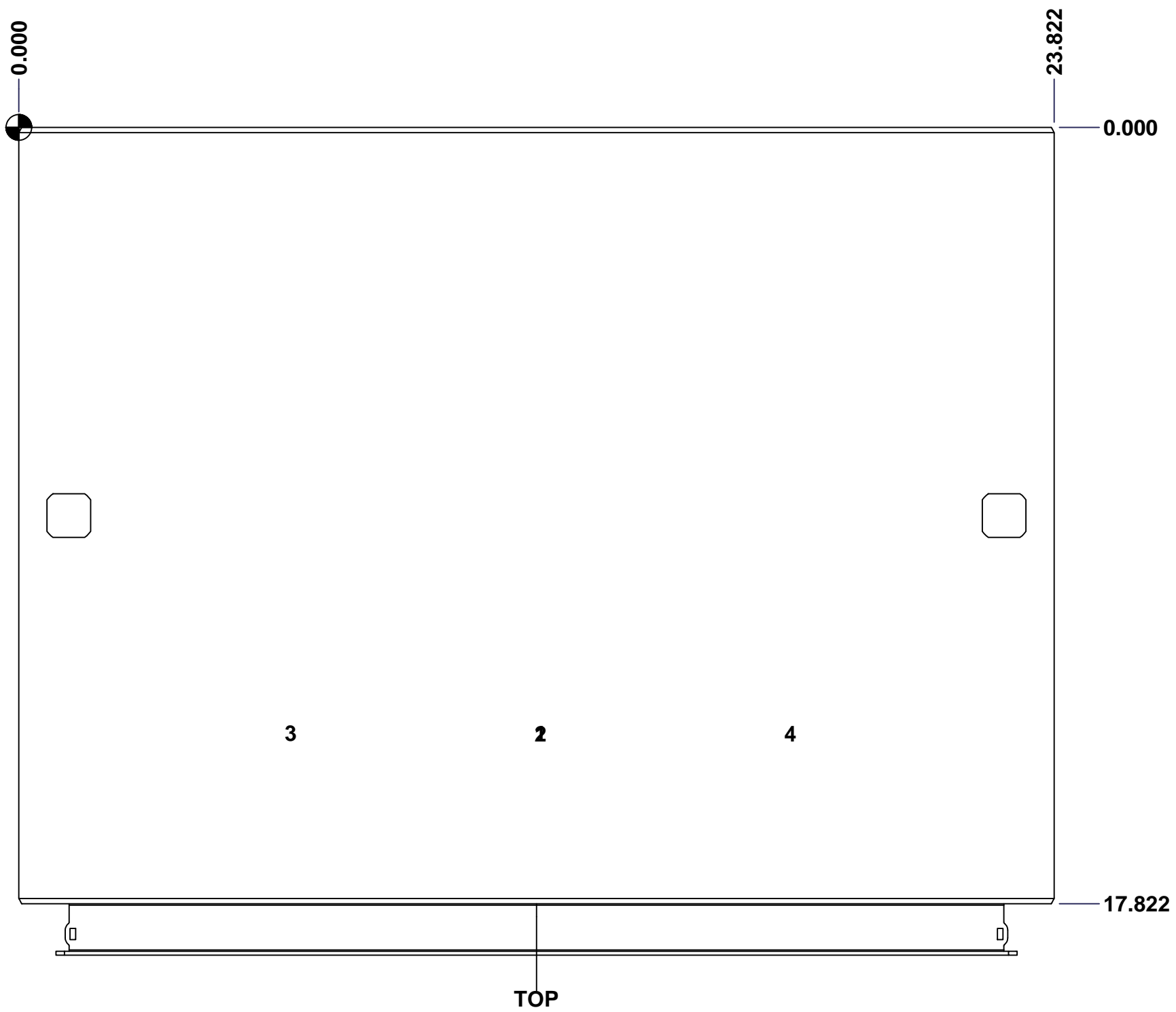

	Description	Status	
	9500 72" x 24" x 18" Body	Released	
	Part Number Numéro Pièce	Rev.	
	9500722418B	0	2 / 7

This drawing is confidential and must not be reproduced or used without the consent of EXM

Ce dessin est confidentiel et ne doit pas être reproduit ou utilisé sans le consentement de EXM

STANDARD FEATURES ARE NOT LISTED IN THIS HOLE TABLE

HOLE TABLE - RIGHT VIEW (CUSTOM FEATURE ONLY)

CUT-OUT	XDIM	YDIM	DESCRIPTION
1	3.161	67.036	STUDS M6 x 10mm (Inside)
2	14.661	67.036	STUDS M6 x 10mm (Inside)
3	8.911	67.036	STUDS M6 x 10mm (Inside)
4	3.161	8.786	STUDS M6 x 10mm (Inside)
5	14.661	8.786	STUDS M6 x 10mm (Inside)
6	8.911	8.786	STUDS M6 x 10mm (Inside)
7	3.161	37.911	STUDS M6 x 10mm (Inside)
8	14.661	37.911	STUDS M6 x 10mm (Inside)
9	8.911	37.911	STUDS M6 x 10mm (Inside)

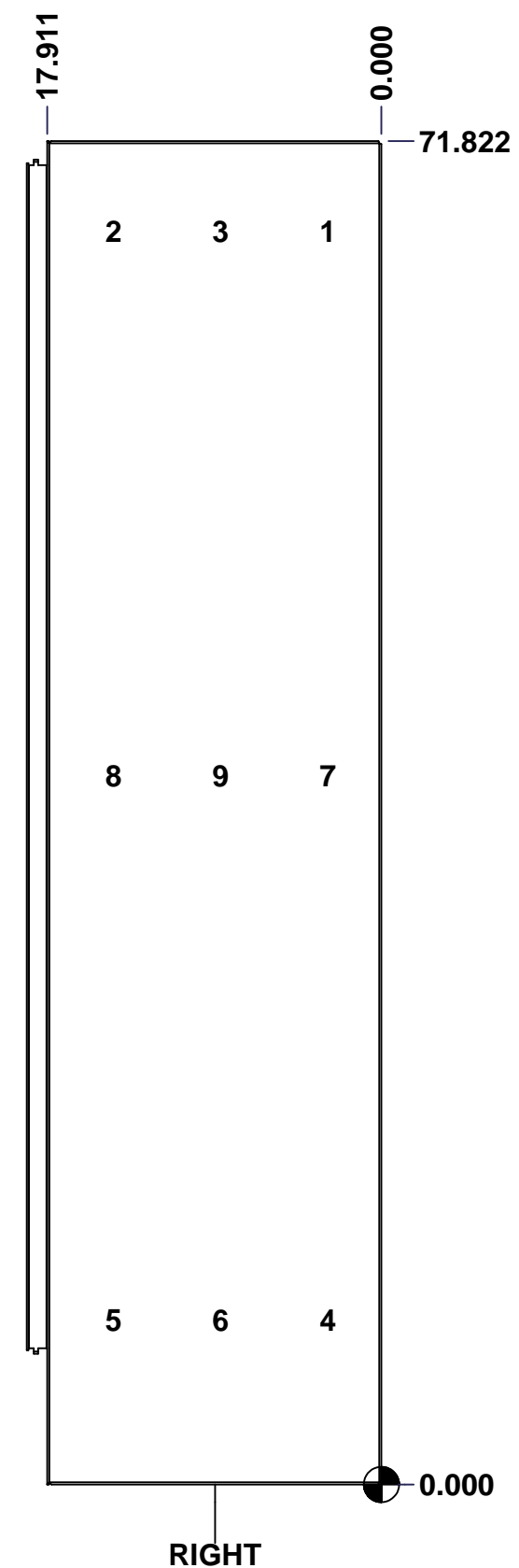

	Description	Status
	9500 72" x 24" x 18" Body	Released
	Part Number Numéro Pièce	Rev.
	9500722418B	0
		3
		7

This drawing is confidential and must not be reproduced or used without the consent of EXM

Ce dessin est confidentiel et ne doit pas être reproduit ou utilisé sans le consentement de EXM

STANDARD FEATURES ARE NOT LISTED IN THIS HOLE TABLE			
HOLE TABLE - BOTTOM VIEW (CUSTOM FEATURE ONLY)			
CUT-OUT	XDIM	YDIM	DESCRIPTION
1	7.286	3.411	GP STUD M6 x 16mm (Inside)
2	16.536	3.411	GP STUD M6 x 16mm (Inside)

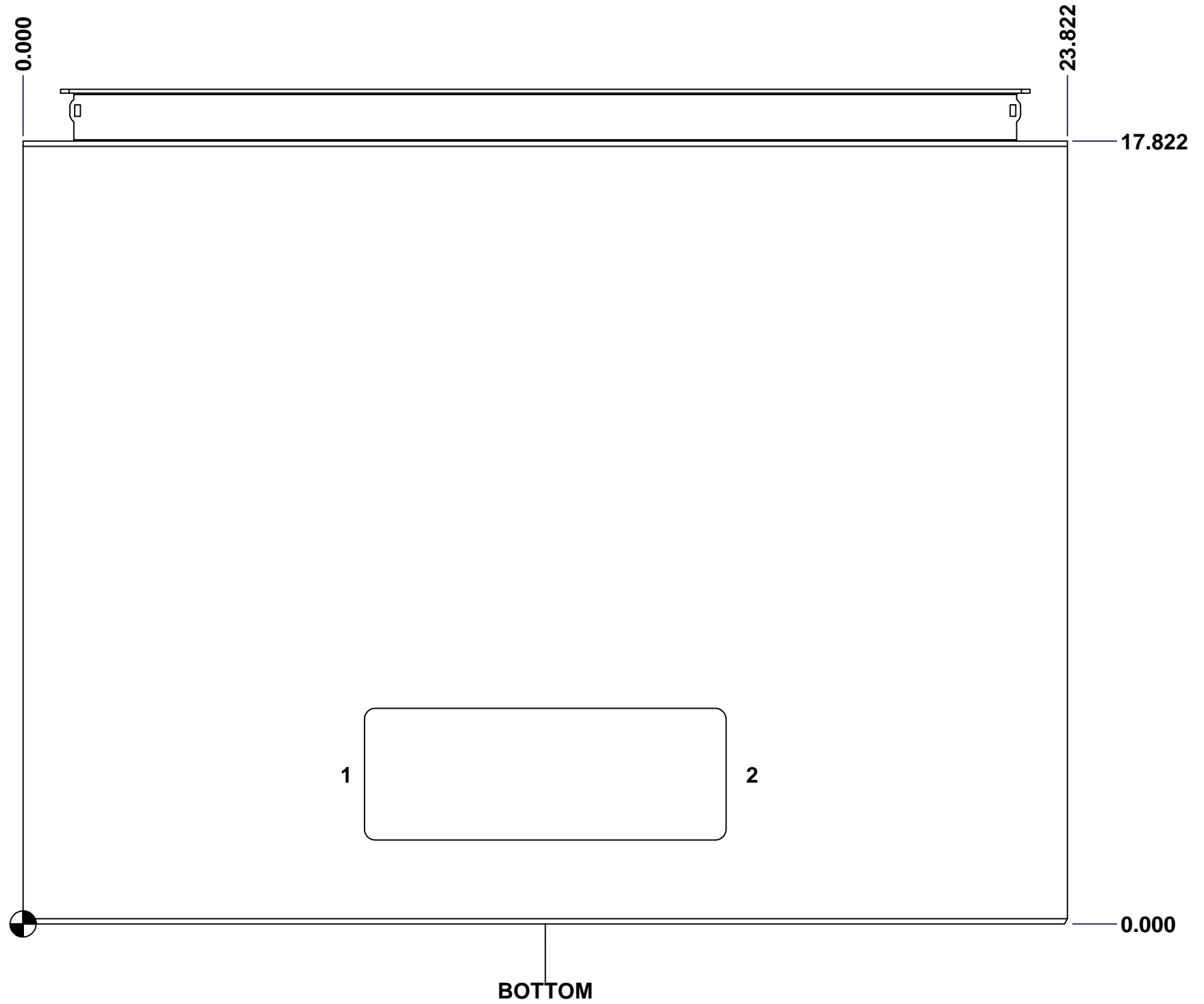

	Description 9500 72" x 24" x 18" Body	Status Released
	Part Number Numéro Pièce 9500722418B	Rev. 4 0 / 7

This drawing is confidential and must not be reproduced or used without the consent of EXM

Ce dessin est confidentiel et ne doit pas être reproduit ou utilisé sans le consentement de EXM

STANDARD FEATURES ARE NOT LISTED IN THIS HOLE TABLE

HOLE TABLE - LEFT VIEW (CUSTOM FEATURE ONLY)

CUT-OUT	XDIM	YDIM	DESCRIPTION
1	16.411	11.286	GND STUD M6 x 16mm (Inside)
2	3.161	67.036	STUDS M6 x 10mm (Inside)
3	14.661	67.036	STUDS M6 x 10mm (Inside)
4	8.911	67.036	STUDS M6 x 10mm (Inside)
5	3.161	8.786	STUDS M6 x 10mm (Inside)
6	14.661	8.786	STUDS M6 x 10mm (Inside)
7	8.911	8.786	STUDS M6 x 10mm (Inside)
8	3.161	37.911	STUDS M6 x 10mm (Inside)
9	14.661	37.911	STUDS M6 x 10mm (Inside)
10	8.911	37.911	STUDS M6 x 10mm (Inside)

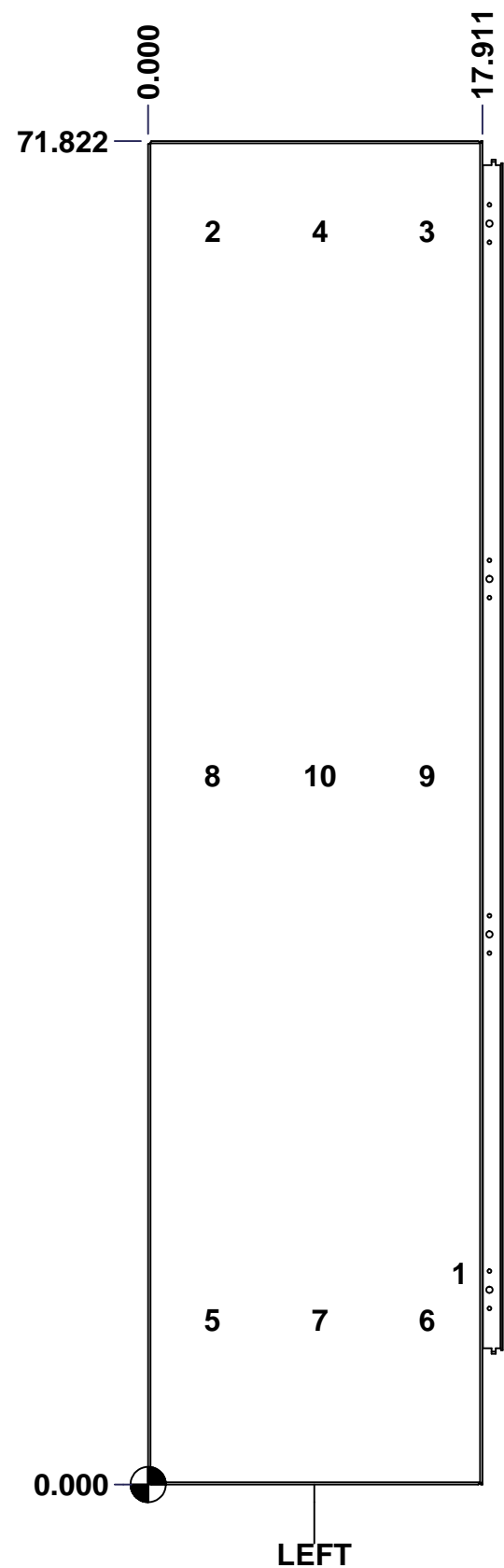

	Description	Status
	9500 72" x 24" x 18" Body	Released
	Part Number Numéro Pièce	Rev.
	9500722418B	0
		5
		7

This drawing is confidential and must not be reproduced or used without the consent of EXM

Ce dessin est confidentiel et ne doit pas être reproduit ou utilisé sans le consentement de EXM

No.	Revisions	Date	By/Par

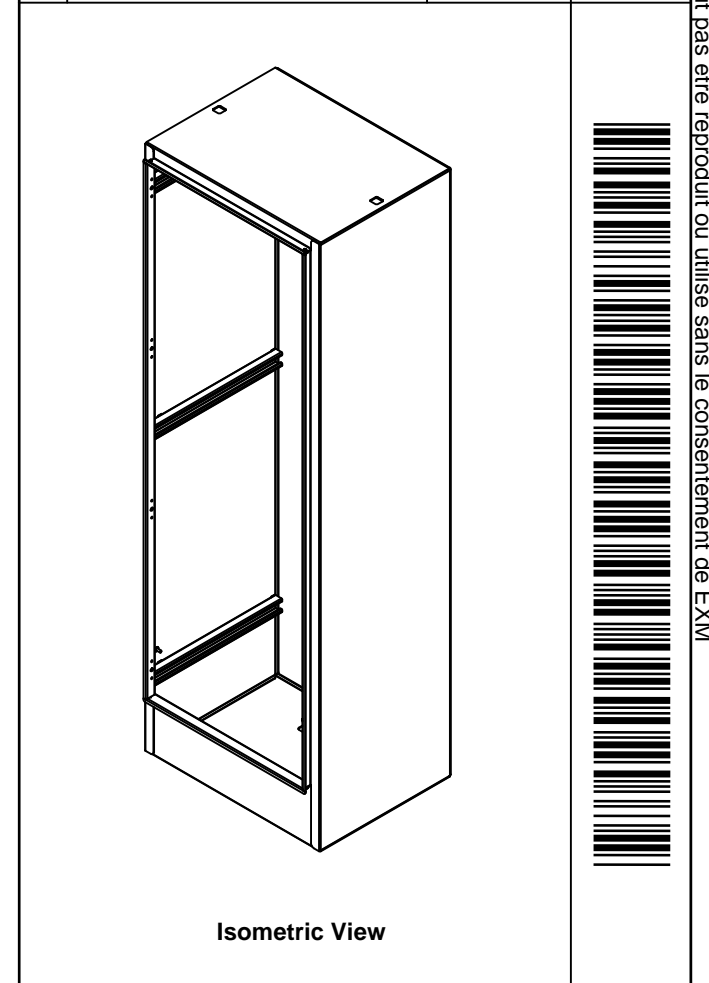

21	STK-Q-16030	0	Stud M6 x 10mm
1	CR400MS_17.5	0	Commercial Roll Mild Steel (17.5in long)
1	STK-P-02400S	0	Powder Paint (Asa-61 Grey / Smooth)
1	STK-Q-52200-18	2	Sasco Strut S5 (15.500" Long)
5	STK-Q-52250-18	2	Sasco Strut S5 (17.500" Long)
1	9500722418BT-P	0	9500 24" x 18" Bottom Part
1	9500722418T-P	0	9500 24" x 18" Top Part
1	9500722418RS-P	0	9500 72" x 24" Right Part
1	9500722418LS-P	0	9500 72" x 24" Left Part
1	9500722418B-P	0	9500 72" x 24" Back Part
21	STK-Q-07220	1	M6 Nylon Insert Lock Nut
3	STK-Q-16080	0	Ground Stud M6 x 16mm
Qty	Part Number	Rev	Description
Parts List			



Tél: (450) 979-4373
Fax: (450) 979-4626
www.exmweb.com

Flatness
Aplatissement
Max 3.0mm

Projection

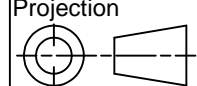

Customer Client Date

Drawn By / Dessiné Par: BoxCad: BoxCad Date: 11-Sep-14

Material / Matière: 12 Ga Cold Rolled A1008 CS Type B (2.5mm)

Color / Couleur: Asa-61 Grey Finish / Fini: Smooth

Description: 9500 72" x 24" x 18" Body Detail Rev.

Part Number / Numéro Pièce: **9500722418B** Rev. 2

0 2

This drawing is confidential and must not be reproduced or used without the consent of EXM

Ce dessin est confidentiel et ne doit pas être reproduit ou utilisé sans le consentement de EXM



TOP

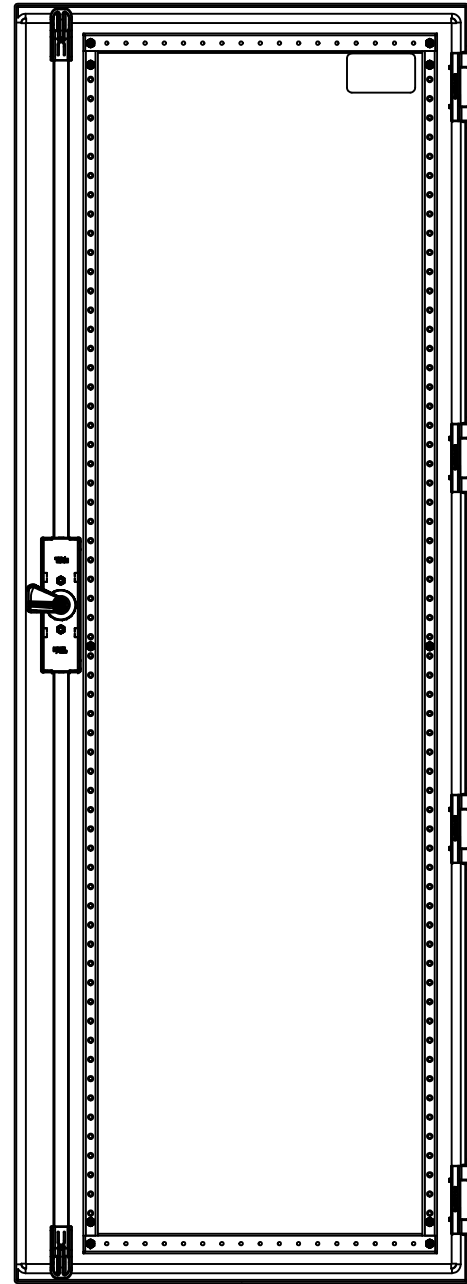

BACK



BOTTOM

0.000
0.835

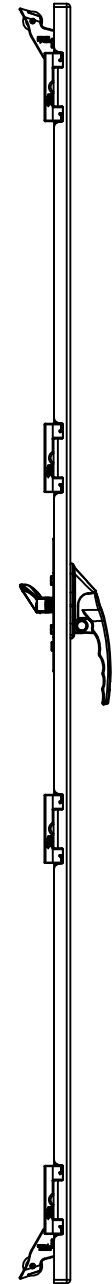

LEFT

0.000

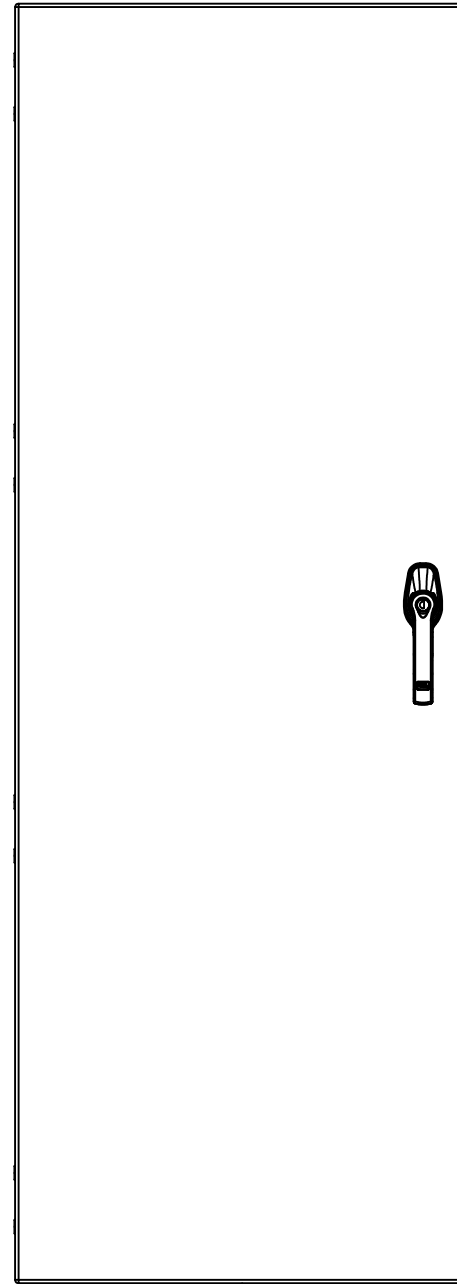

FRONT

23.312

65.549

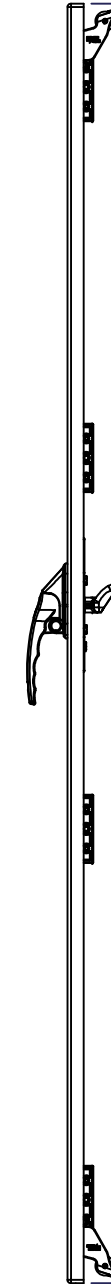

RIGHT

0.000

No.	Revisions	Date	By/Par

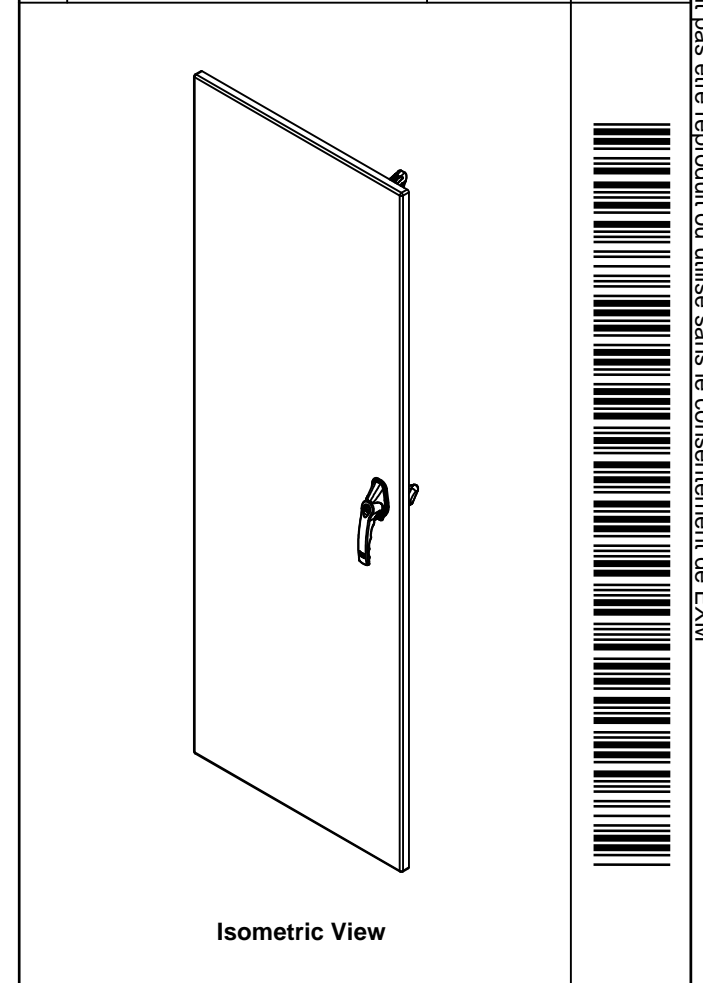

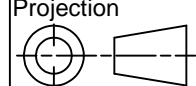
 Tél: (450) 979-4373 Fax: (450) 979-4626 www.exmweb.com		Flatness Aplatissement	
		Max 3.0mm	
Customer Client		Date	
Drawn By Dessiné Par BoxCad: BoxCad		Date 11-Sep-14	
Material Matière 12 Ga Cold Rolled A1008 CS Type B (2.5mm)		Projection	
Color Couleur Asa-61 Grey		 Finish Fini Smooth	
Description 9500 72" x 24" Cover		Detail Rev.	
Part Number Numéro Pièce 9500722418C		Rev. 0	1 / 3

SEE BILL OF MATERIAL ON LAST PAGE

This drawing is confidential and must not be reproduced or used without the consent of EXM

Ce dessin est confidentiel et ne doit pas être reproduit ou utilisé sans le consentement de EXM

STANDARD FEATURES ARE NOT LISTED IN THIS HOLE TABLE

HOLE TABLE - FRONT VIEW (CUSTOM FEATURE ONLY)

CUT-OUT	XDIM	YDIM	DESCRIPTION
1	2.000	2.028	STUD M6 x 18mm (Inside)
2	2.000	32.628	STUD M6 x 18mm (Inside)
3	2.000	63.521	STUD M6 x 18mm (Inside)
4	19.407	2.028	STUD M6 x 18mm (Inside)
5	19.407	32.628	STUD M6 x 18mm (Inside)
6	19.407	63.521	STUD M6 x 18mm (Inside)
7	2.000	3.139	STUD M6 x 18mm (Inside)
8	2.000	62.409	STUD M6 x 18mm (Inside)
9	19.407	3.139	STUD M6 x 18mm (Inside)
10	19.407	62.409	STUD M6 x 18mm (Inside)
11	20.937	6.118	STUD M6 x 18mm (Inside)
12	20.937	59.430	STUD M6 x 18mm (Inside)
-----	-----	-----	-----
13	20.937	34.743	HANDLE 885 ESL2A-APHK @ 0.0°

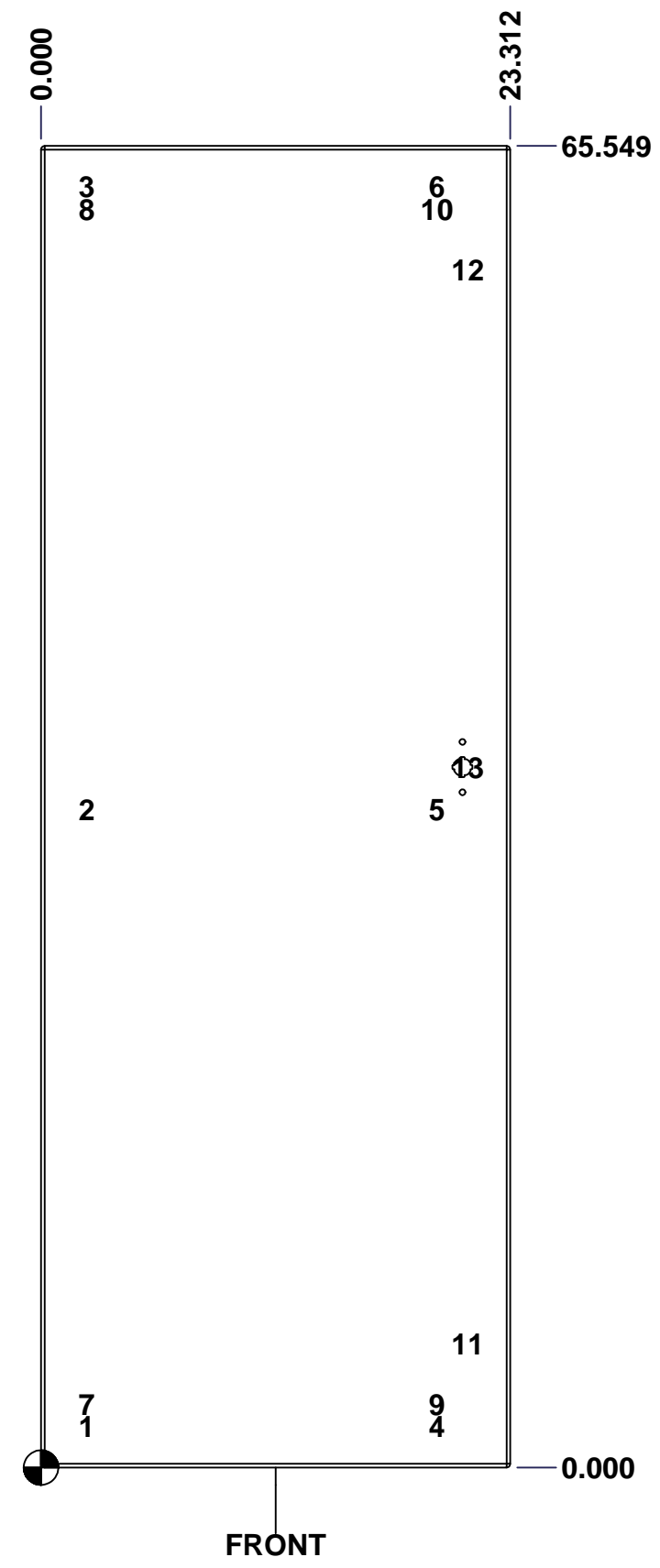

FRONT

	Description	Status	
	9500 72" x 24" Cover	(NULL)	
	Part Number Numéro Pièce	Rev.	
	9500722418C	0	2 3

This drawing is confidential and must not be reproduced or used without the consent of EXM

Ce dessin est confidentiel et ne doit pas être reproduit ou utilisé sans le consentement de EXM

No.	Revisions	Date	By/Par

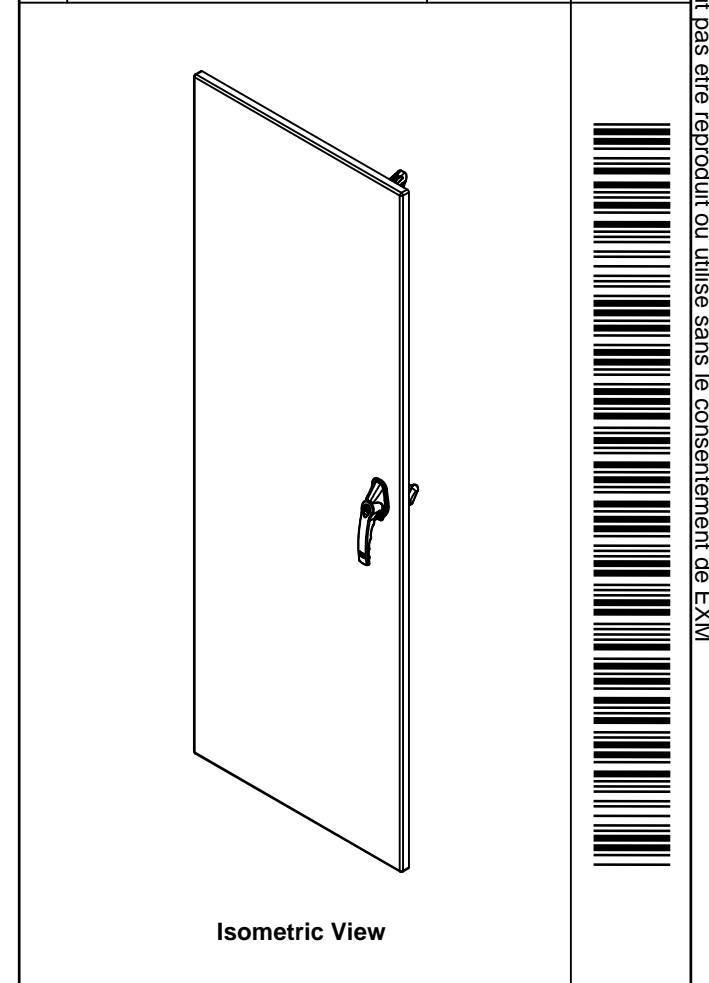

Qty	Part Name	Rev	Description
1	STK-Q-47527	1	9500 Lower Closing Bar 72"
1	STK-Q-47517	1	9500 Upper Closing Bar 72"
1	STK-A-03886-36	2	Gearbox Clockwise Assembly (36.0mm)
1	885ESL2A-APHK	6	885 ESL2A-APHK - Zinc Die Cast L-Handle Padlockable Assy
1	STK-P-02400S	0	Powder Paint (Asa-61 Grey / Smooth)
1	STK-S-00100	0	3.5" x 2" Silver Milar Flexcon Sticker
1	9500722418G	0	9500 72" x 24" Cover Gasket
1	STK-K-10830	3	9500 - Door Stiffener Assembly
2	STK-Q-16410	0	Guide Stud - Largel (No Paint Cap Required)
10	STK-Q-16055	1	M6 x 18mm Stud (No Paint Cap Required)
1	9500722418C-P	0	9500 72" x 24" Cover Part
4	STK-K-09860	7	Cabinet Hinge with Captive Pins
2	STK-A-90025	0	9500 - Cabinet Closing Bar End (Large)
Qty	Part Name	Rev	Description
Parts List			



Tél: (450) 979-4373
Fax: (450) 979-4626
www.exmweb.com

Flatness
Aplatissement
Max 3.0mm

Projection

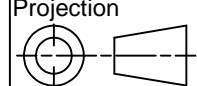

Customer Client		Date
Drawn By / Dessiné Par: BoxCad: BoxCad		Date: 11-Sep-14
Material / Matière: 12 Ga Cold Rolled A1008 CS Type B (2.5mm)		
Color / Couleur: Asa-61 Grey	Finish / Fini: Smooth	
Description: 9500 72" x 24" Cover		Detail Rev.
Part Number / Numéro Pièce: 9500722418C		Rev. 3
		0

All knockouts are actual size / Les disques défonçables sont grandeur réel
 All dimensions are before paint / Toutes les dimensions sont avant peinture

This drawing is confidential and must not be reproduced or used without the consent of EXM

Ce dessin est confidentiel et ne doit pas être reproduit ou utilisé sans le consentement de EXM

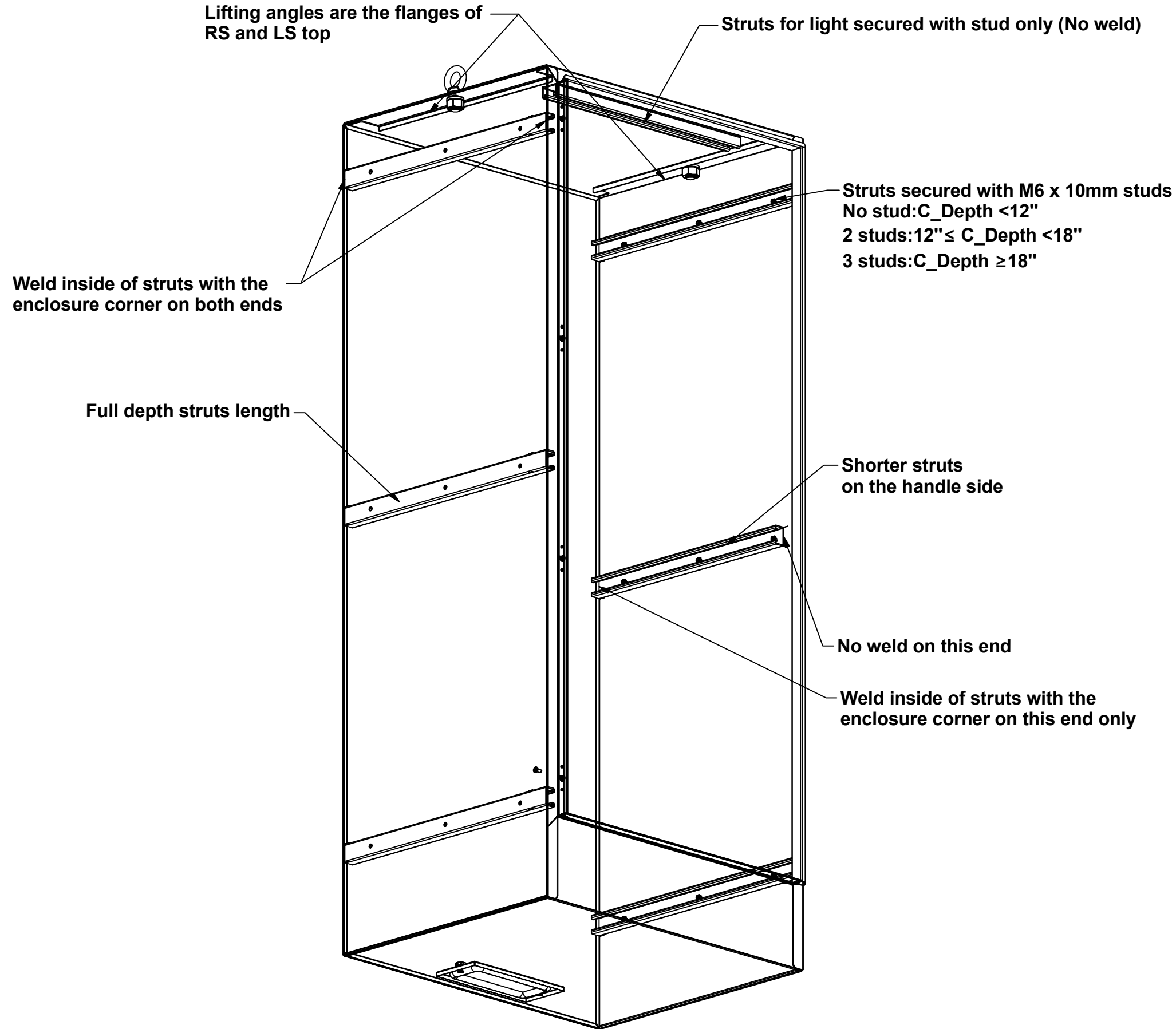

No.	Revisions	Date	By/Par

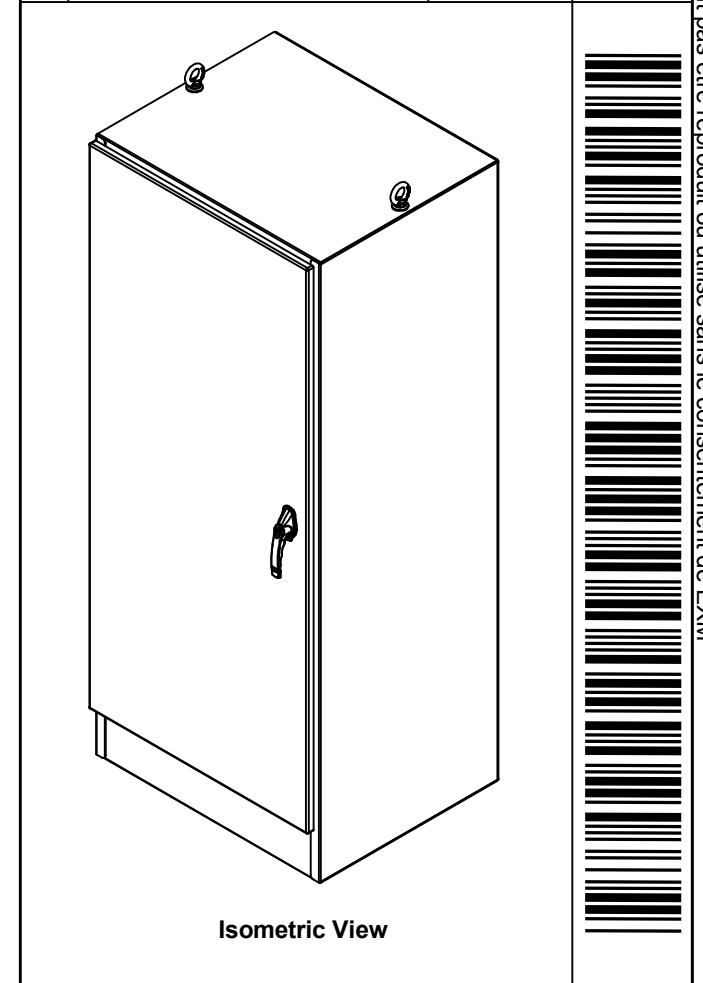

Tél: (450) 979-4373 Fax: (450) 979-4626 www.exmweb.com		Flatness Aplatissement
		Max 3.0mm
Customer Client		Date
Drawn By Dessiné Par PatrickD		Date 3/9/2020
Material Matière N/A		
Color Couleur N/A	Finish Fini N/A	
Description 9500 Welding Detail		Detail Rev.
Part Number Numéro Pièce 9500_WELDING_DETAIL		Rev. 1
		0 / 1