

This drawing is confidential and must not be reproduced or used without the consent of EXM

Ce dessin est confidentiel et ne doit pas être reproduit ou utilisé sans le consentement de EXM

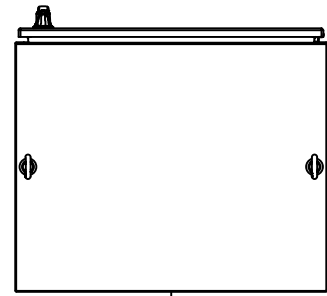

TOP

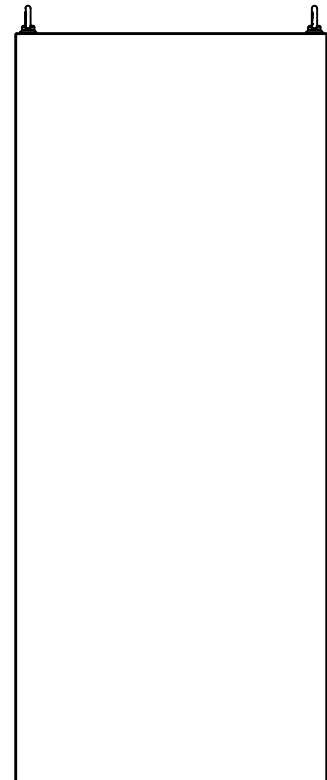

BACK

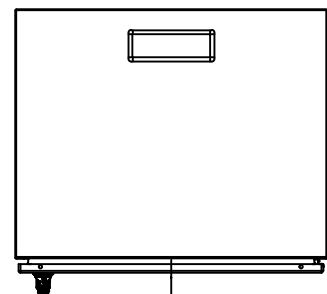

BOTTOM

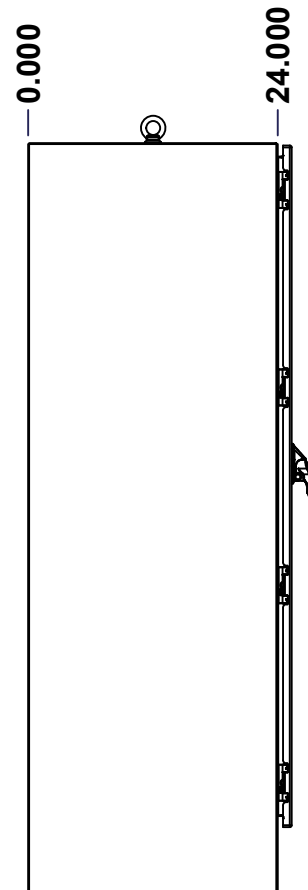

LEFT

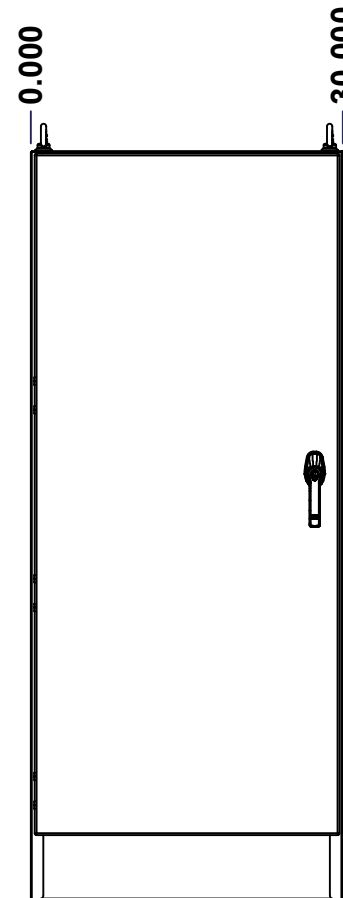

FRONT

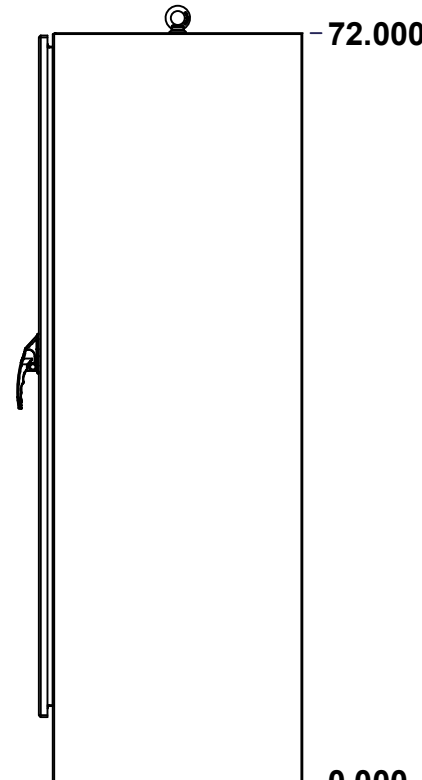

RIGHT

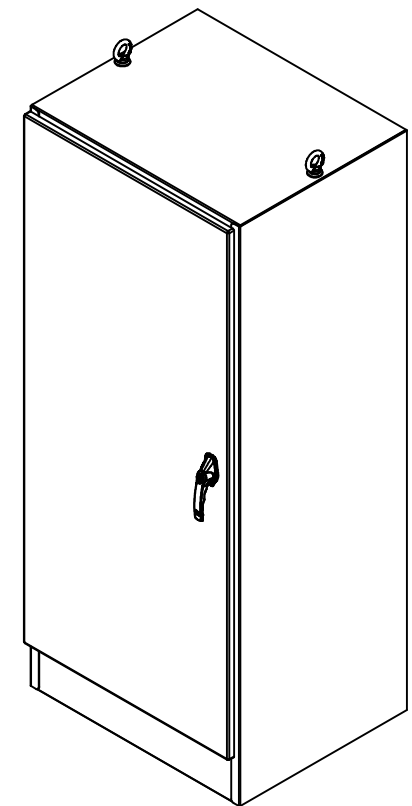

Isometric View

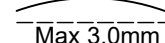
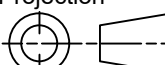

No.	Revisions	Date	By/Par

 Tél: (450) 979-4373 Fax: (450) 979-4626 www.exmweb.com		Flatness Aplatissement  Max 3.0mm Projection 
Customer Client	Date	
Drawn By Dessiné Par	BoxCad: BoxCad	Date 11-Sep-14
Material Matière	12 Ga Cold Rolled A1008 CS Type B (2.5mm)	
Color Couleur	Asa-61 Grey	Finish Fini Smooth
Description	Detail Rev.	
9500 72" x 30" x 24" Assembly		
Part Number Numéro Pièce	Rev. 0	1 / 11
9500723024		

SEE BILL OF MATERIAL ON LAST PAGE

This drawing is confidential and must not be reproduced or used without the consent of EXM

Ce dessin est confidentiel et ne doit pas être reproduit ou utilisé sans le consentement de EXM

NOTE	
ITEM	DESCRIPTION
1	NEMA 12/13 Enclosure
2	C/W Standard ground studs on box and cover
3	C/W Standard door stiffener
4	W/O Inner panel
5	C/W Standard inner panel mounting struts
6	C/W Eyebolts
7	C/W Struts installed (Included)

No.	Revisions	Date	By/Par

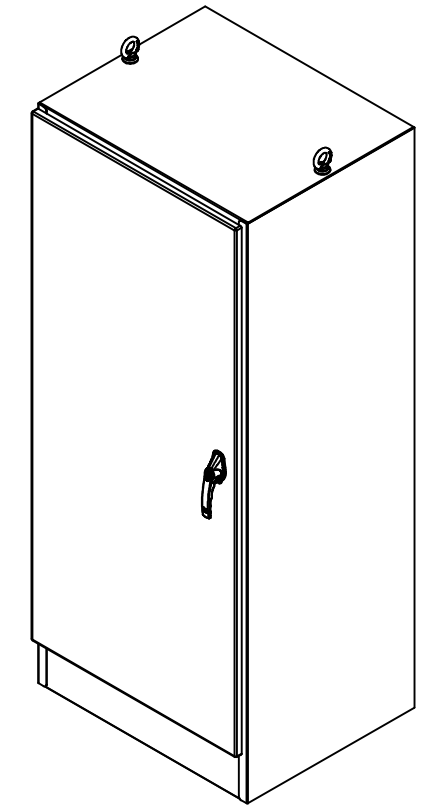

Isometric View

PACKING		
ITEM	QTY	DESCRIPTION
Cardboard sleeve	2	Top and Bottom
Cardboard strip	2	Between back of enclosure and inner panel
Plastic bag	1	To protect cover surface and inside gasket
Cardboard corner	4	To reinforced for the plastic strap tightening
Plastic strap - Black	2	To Squeeze 2 cardboard sleeve together
Packaging label	3	White label with PN
Plastic strap- Green	2	To secure the enclosure to the wood pallet
Wood Pallet	1	2" deeper and 3" larger than enclosure size

1	9500723024GP	0	9500 Gland Plate
1	880EB14	2	Eye Bolt M14 (Pack of 2)
1	9500723024C	0	9500 72" x 30" Cover
1	9500723024B	0	9500 72" x 30" x 24" Body
4	STK-Q-04050-10	8	M6 x 10mm Hexagon Socket Head Machine Screw with Nyseal
Qty	Part Number	Rev	Description
Parts List			

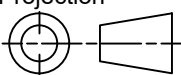
 Tél: (450) 979-4373 Fax: (450) 979-4626 www.exmweb.com		Flatness Aplatissement Max 3.0mm Projection 
Customer Client	Date	
Drawn By Dessiné Par	BoxCad: BoxCad	Date 11-Sep-14
Material Matière	12 Ga Cold Rolled A1008 CS Type B (2.5mm)	
Color Couleur	Asa-61 Grey	Finish Fini Smooth
Description	Detail Rev.	
9500 72" x 30" x 24" Assembly		
Part Number Numéro Pièce	9500723024	Rev. 0
		2 / 11

This drawing is confidential and must not be reproduced or used without the consent of EXM

Ce dessin est confidentiel et ne doit pas être reproduit ou utilisé sans le consentement de EXM

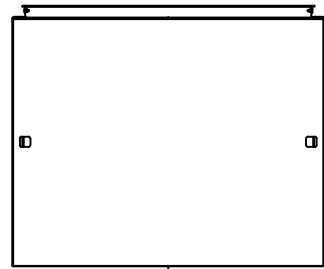

TOP

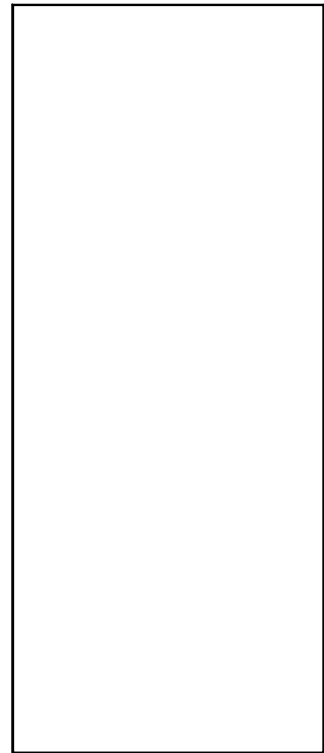

BACK

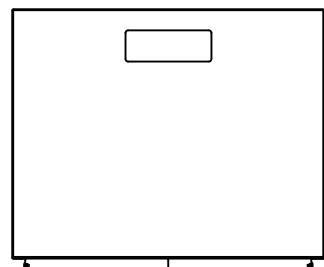

BOTTOM

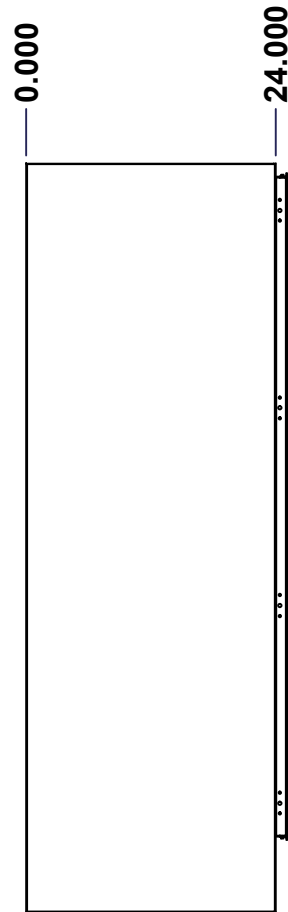

LEFT

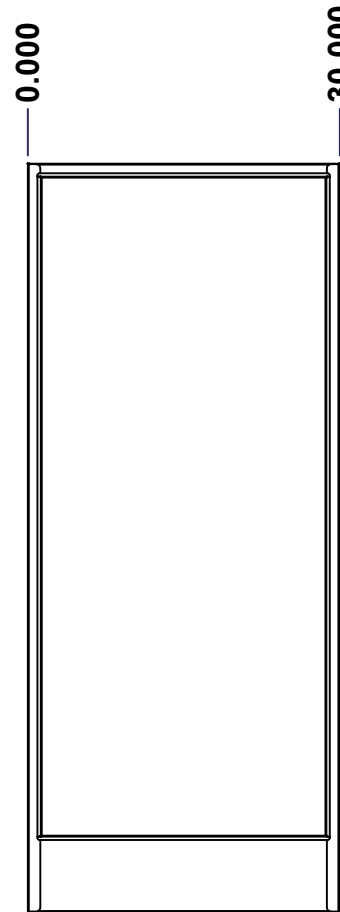

FRONT

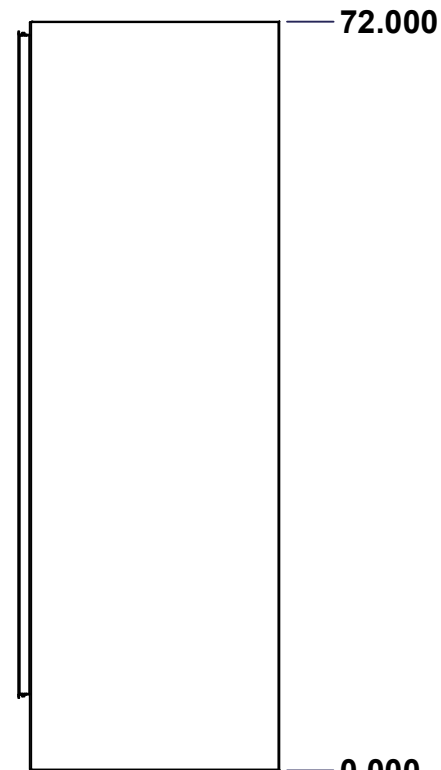

RIGHT

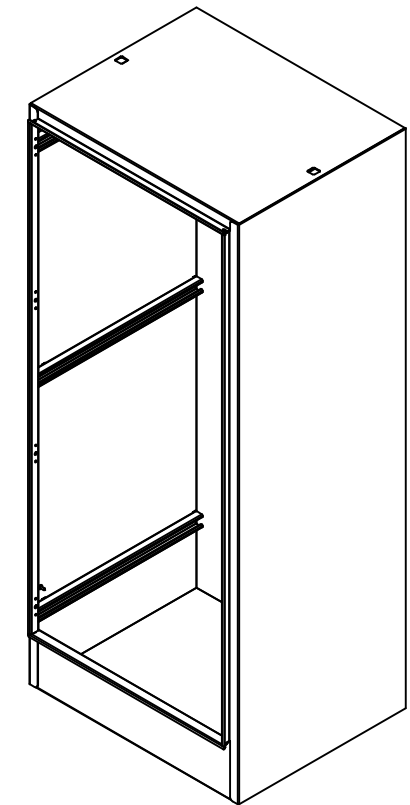

Isometric View

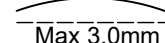
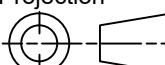

No.	Revisions	Date	By/Par

 Tél: (450) 979-4373 Fax: (450) 979-4626 www.exmweb.com		Flatness Aplatissement  Max 3.0mm Projection 
Customer Client	Date	
Drawn By Dessiné Par	BoxCad: BoxCad	Date 11-Sep-14
Material Matière	12 Ga Cold Rolled A1008 CS Type B (2.5mm)	
Color Couleur	Asa-61 Grey	Finish Fini Smooth
Description 9500 72" x 30" x 24" Body		Detail Rev.
Part Number Numéro Pièce	Rev. 0	3 / 11

SEE BILL OF MATERIAL ON LAST PAGE

9500723024B

This drawing is confidential and must not be reproduced or used without the consent of EXM

Ce dessin est confidentiel et ne doit pas être reproduit ou utilisé sans le consentement de EXM

STANDARD FEATURES ARE NOT LISTED IN THIS HOLE TABLE

HOLE TABLE - TOP VIEW (CUSTOM FEATURE ONLY)

CUT-OUT	XDIM	YDIM	DESCRIPTION
1	14.911	19.911	Struts CR400 21.500" (Inside)
2	14.911	20.840	STUDS M6 x 10mm (Inside)
3	25.777	19.911	STUDS M6 x 10mm (Inside)

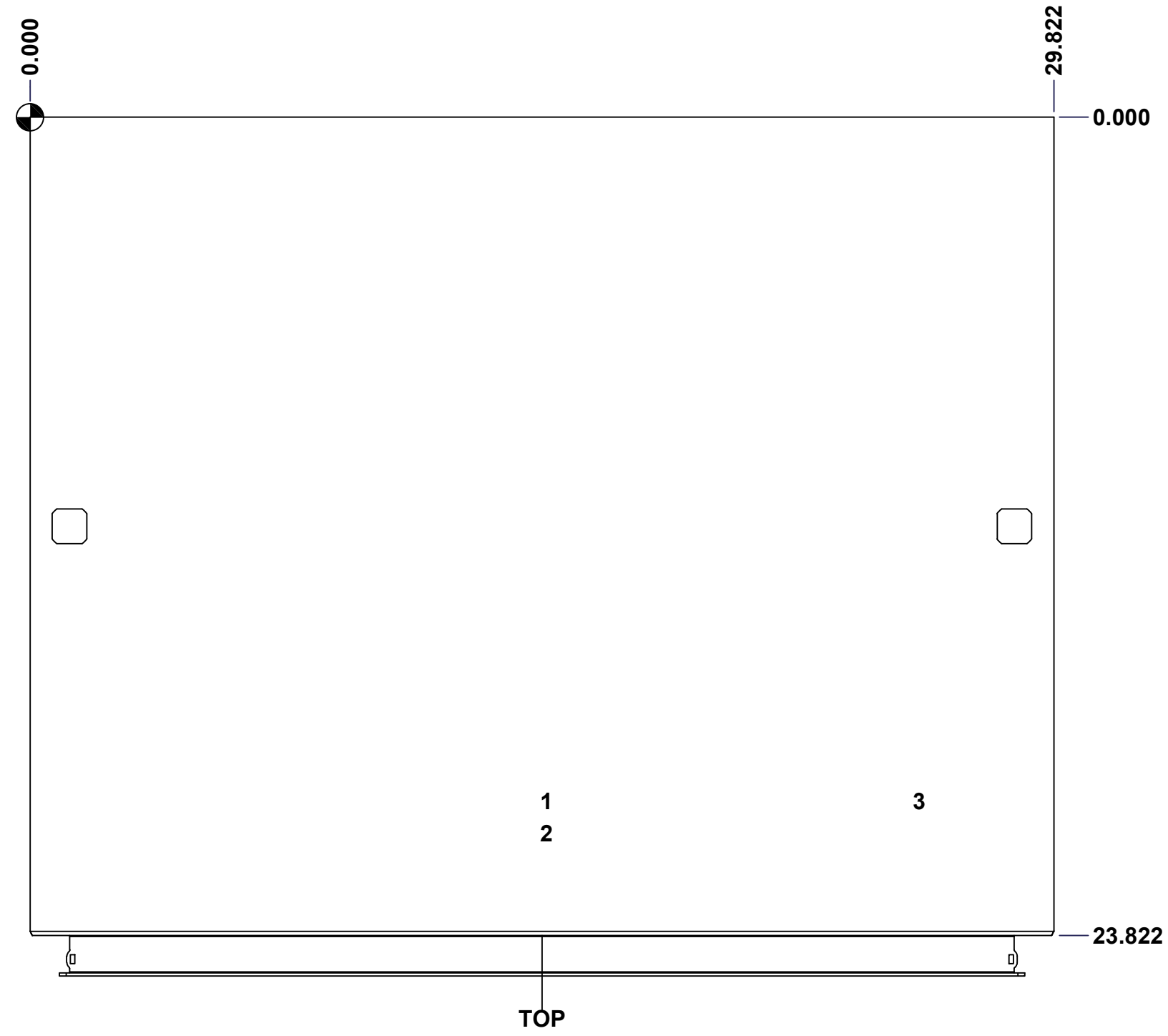

	Description 9500 72" x 30" x 24" Body	Status (NULL)
	Part Number Numéro Pièce 9500723024B	Rev. 4 0

This drawing is confidential and must not be reproduced or used without the consent of EXM

Ce dessin est confidentiel et ne doit pas être reproduit ou utilisé sans le consentement de EXM

STANDARD FEATURES ARE NOT LISTED IN THIS HOLE TABLE

HOLE TABLE - RIGHT VIEW (CUSTOM FEATURE ONLY)

CUT-OUT	XDIM	YDIM	DESCRIPTION
1	7.536	66.107	STUDS M6 x 10mm (Inside)
2	16.286	66.107	STUDS M6 x 10mm (Inside)
3	7.536	7.857	STUDS M6 x 10mm (Inside)
4	16.286	7.857	STUDS M6 x 10mm (Inside)
5	7.536	36.982	STUDS M6 x 10mm (Inside)
6	16.286	36.982	STUDS M6 x 10mm (Inside)

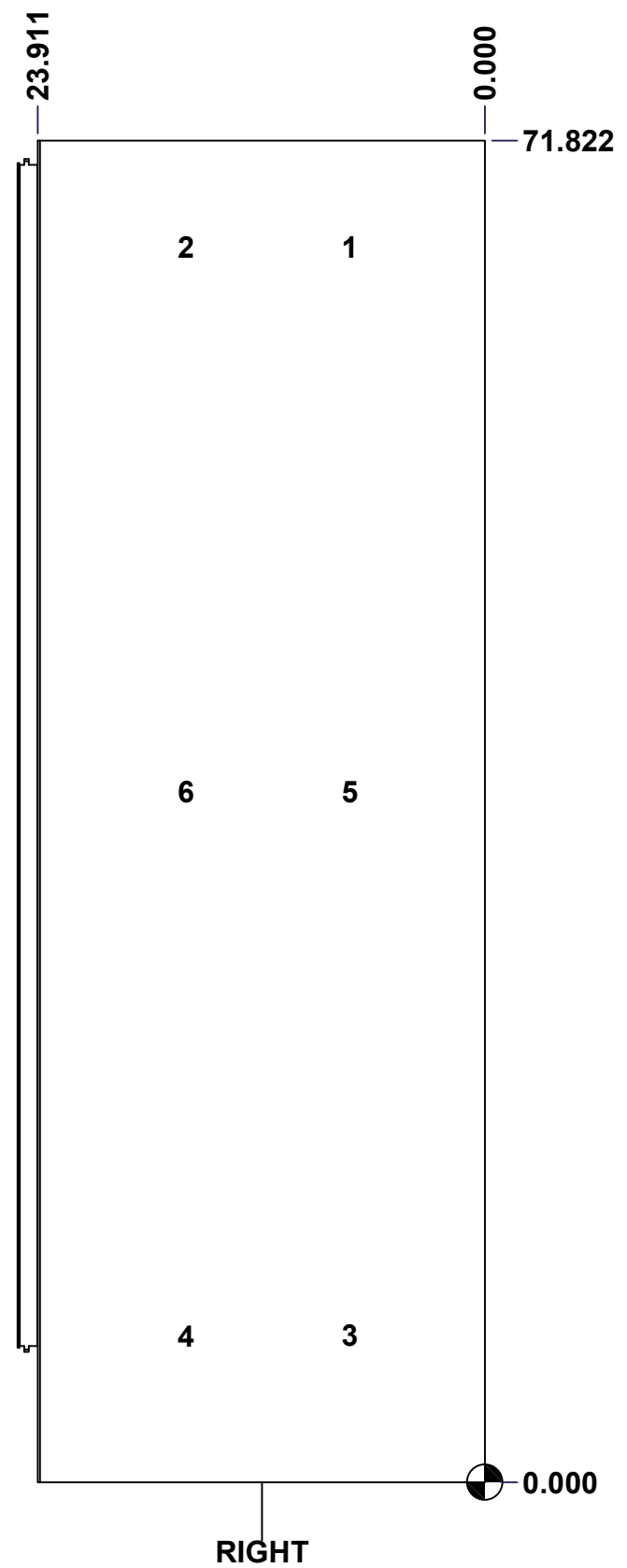

	Description 9500 72" x 30" x 24" Body	Status (NULL)
	Part Number Numéro Pièce 9500723024B	Rev. 5 0

This drawing is confidential and must not be reproduced or used without the consent of EXM

Ce dessin est confidentiel et ne doit pas être reproduit ou utilisé sans le consentement de EXM

STANDARD FEATURES ARE NOT LISTED IN THIS HOLE TABLE			
HOLE TABLE - BOTTOM VIEW (CUSTOM FEATURE ONLY)			
CUT-OUT	XDIM	YDIM	DESCRIPTION
1	10.286	3.411	GP STUD M6 x 16mm (Inside)
2	19.536	3.411	GP STUD M6 x 16mm (Inside)

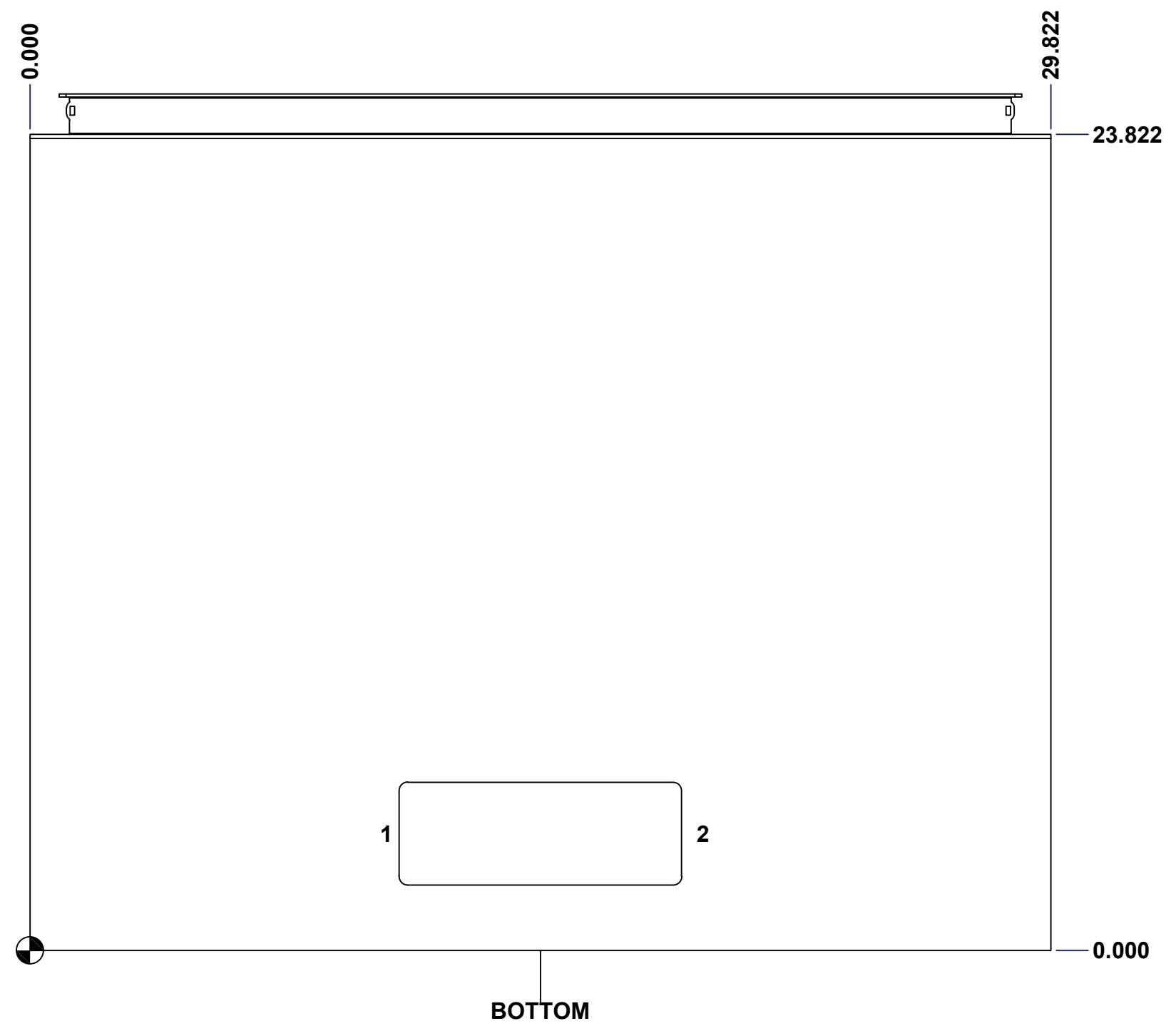

	Description 9500 72" x 30" x 24" Body	Status (NULL)
	Part Number Numéro Pièce 9500723024B	Rev. 6 0 / 11

This drawing is confidential and must not be reproduced or used without the consent of EXM

Ce dessin est confidentiel et ne doit pas être reproduit ou utilisé sans le consentement de EXM

STANDARD FEATURES ARE NOT LISTED IN THIS HOLE TABLE

HOLE TABLE - LEFT VIEW (CUSTOM FEATURE ONLY)

CUT-OUT	XDIM	YDIM	DESCRIPTION
1	22.411	11.286	GND STUD M6 x 16mm (Inside)
2	7.536	66.107	STUDS M6 x 10mm (Inside)
3	16.286	66.107	STUDS M6 x 10mm (Inside)
4	7.536	7.857	STUDS M6 x 10mm (Inside)
5	16.286	7.857	STUDS M6 x 10mm (Inside)
6	7.536	36.982	STUDS M6 x 10mm (Inside)
7	16.286	36.982	STUDS M6 x 10mm (Inside)

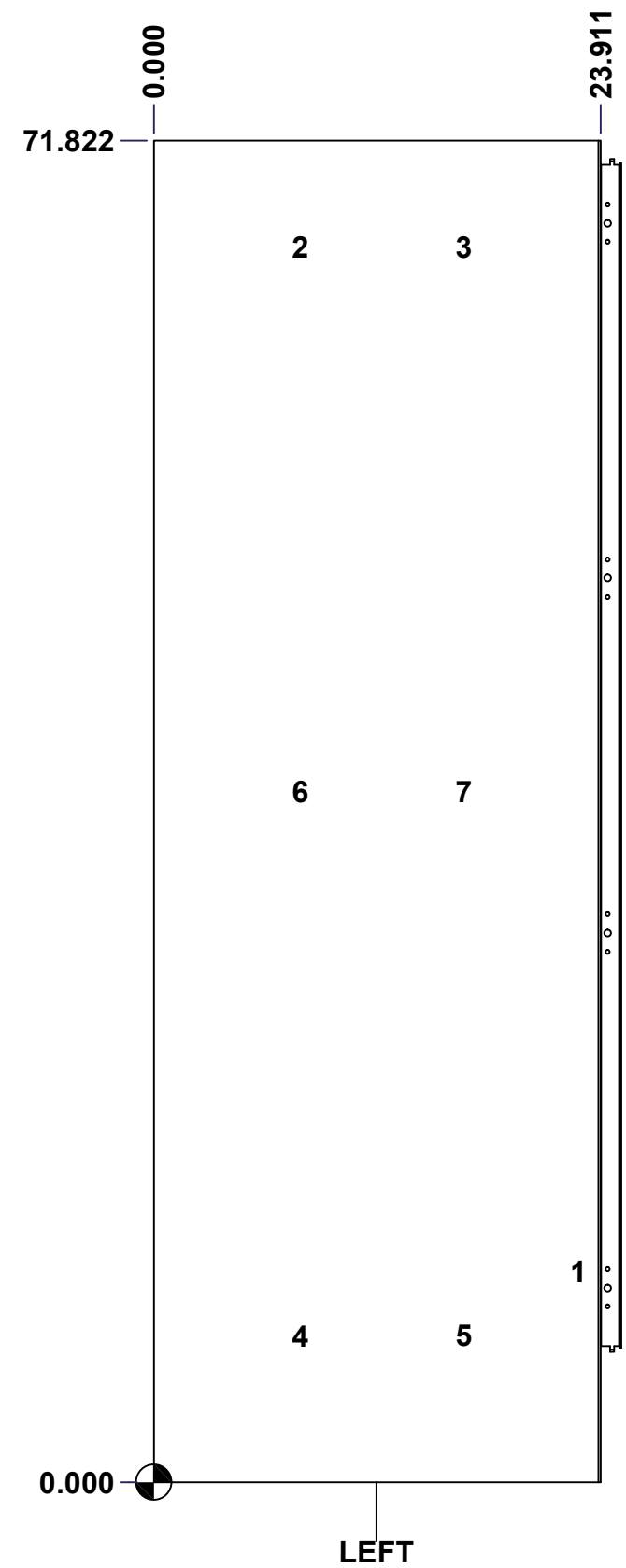

	Description	Status	
	9500 72" x 30" x 24" Body	(NULL)	
	Part Number Numéro Pièce	Rev.	7
	9500723024B	0	11

This drawing is confidential and must not be reproduced or used without the consent of EXM

Ce dessin est confidentiel et ne doit pas être reproduit ou utilisé sans le consentement de EXM

No.	Revisions	Date	By/Par

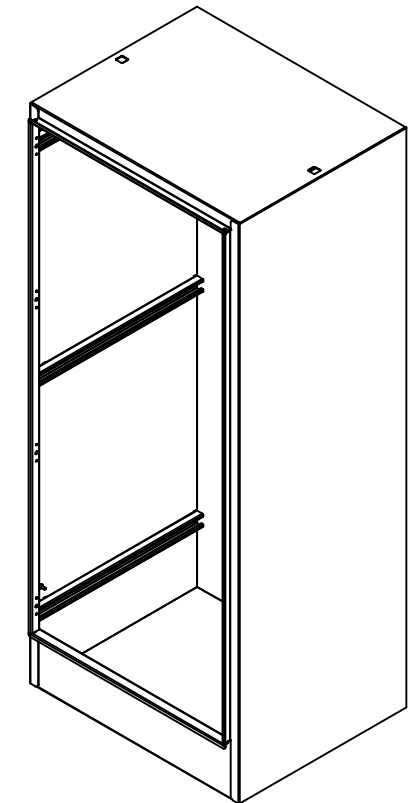

Isometric View

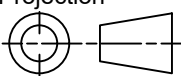

Qty	Part Number	Rev	Description
14	STK-Q-16030	0	Stud M6 x 10mm Steel
1	CR400MS_21.5	0	Commercial Roll Mild Steel (21.5in long)
2	STK-Q-74910	0	Eyebolt Lifting Angle (15.500")
1	STK-P-02400S	0	Powder Paint (Asa-61 Grey / Smooth)
1	STK-Q-52200-24	2	Sasco Strut S5 (21.500" Long)
5	STK-Q-52250-24	2	Sasco Strut S5 (23.500" Long)
1	9500723024BT-P	0	9500 30" x 24" Bottom Part
1	9500723024T-P	0	9500 30" x 24" Top Part
1	9500723024RS-P	0	9500 72" x 30" Right Part
1	9500723024LS-P	0	9500 72" x 30" Left Part
1	9500723024B-P	0	9500 72" x 30" Back Part
3	STK-Q-16080	0	Ground Stud M6 x 16mm Steel

 Tél: (450) 979-4373 Fax: (450) 979-4626 www.exmweb.com		Flatness Aplatissement Max 3.0mm Projection 
Customer Client	Date	
Drawn By Dessiné Par	BoxCad: BoxCad	Date 11-Sep-14
Material Matière	12 Ga Cold Rolled A1008 CS Type B (2.5mm)	
Color Couleur	Asa-61 Grey	Finish Fini Smooth
Description		Detail Rev.
9500 72" x 30" x 24" Body		
Part Number Numéro Pièce	Rev.	8
9500723024B	0	11

Parts List

This drawing is confidential and must not be reproduced or used without the consent of EXM

Ce dessin est confidentiel et ne doit pas être reproduit ou utilisé sans le consentement de EXM

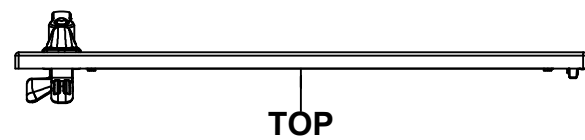

TOP

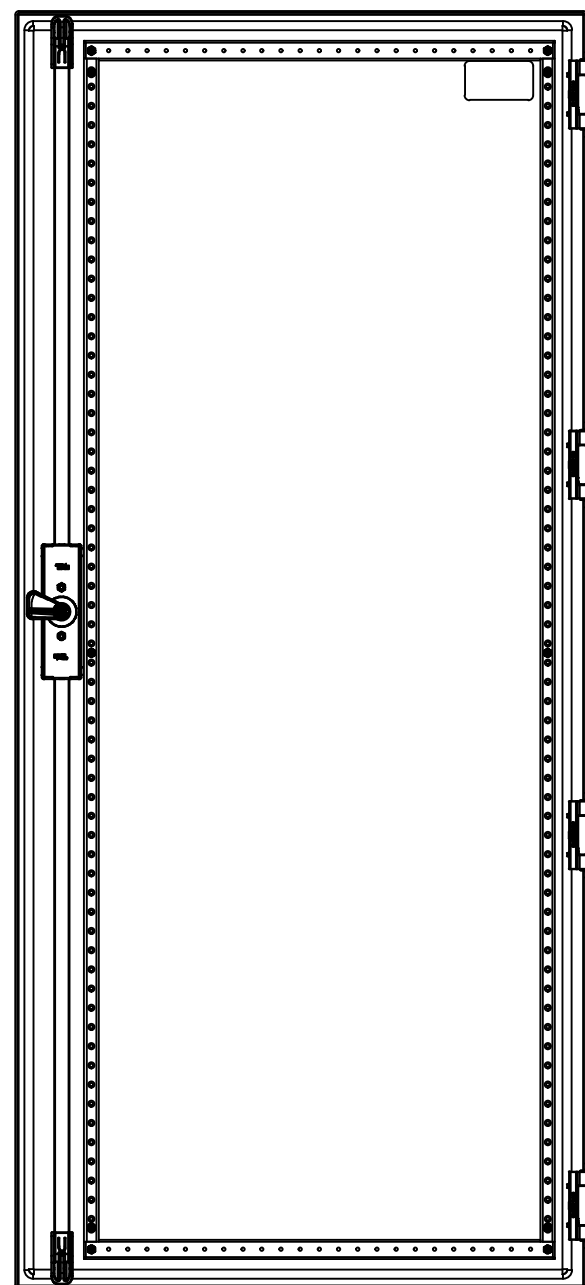

BACK



BOTTOM

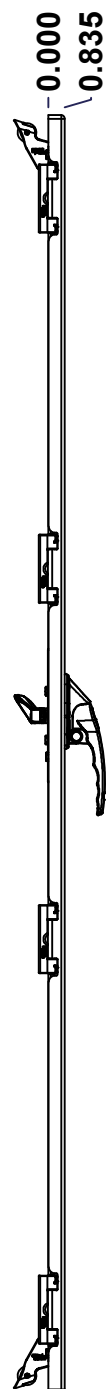

LEFT

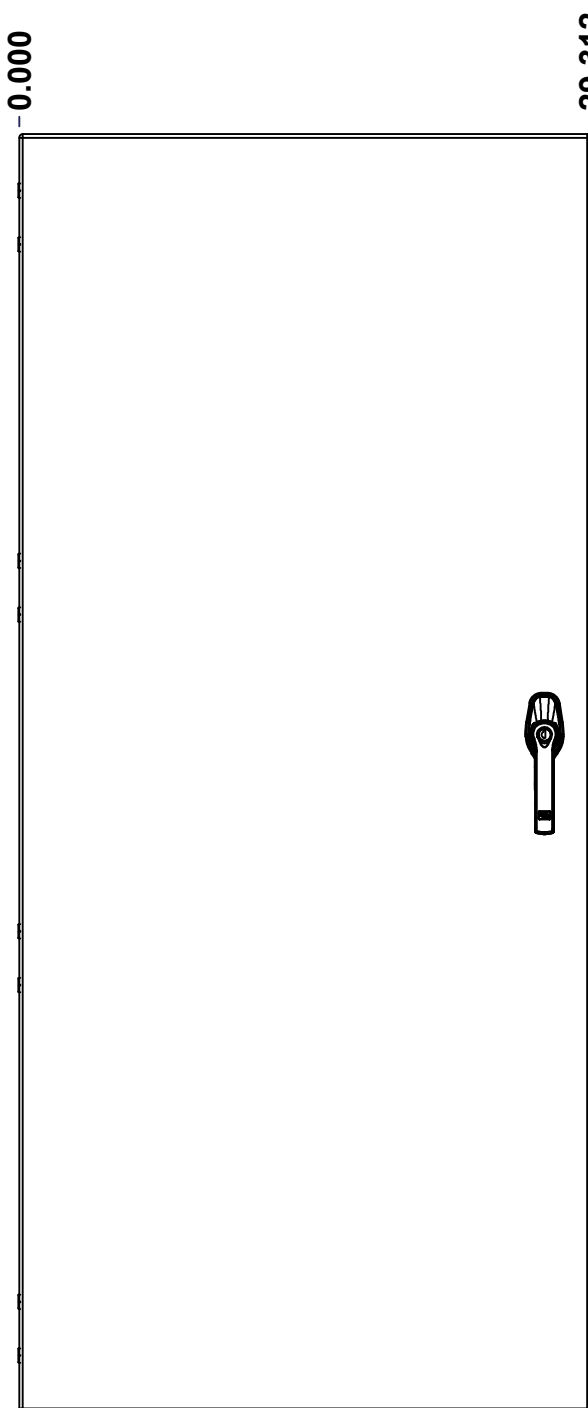

FRONT

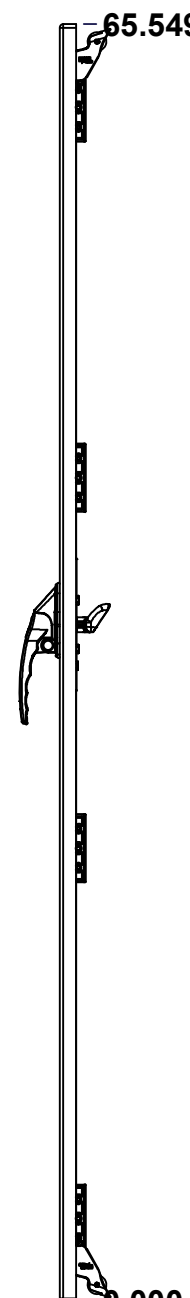

RIGHT

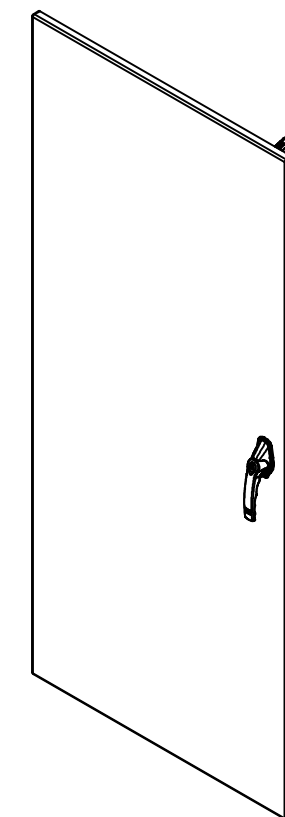

Isometric View



No.	Revisions	Date	By/Par

EXM
exm

Tél: (450) 979-4373
Fax: (450) 979-4626
www.exmweb.com

Flatness
Aplatissement
Max 3.0mm

Projection

Customer Client	Date
Drawn By Dessiné Par BoxCad: BoxCad	Date 11-Sep-14

Material
Matière 12 Ga Cold Rolled A1008 CS Type B (2.5mm)

Color Couleur Asa-61 Grey	Finish Fini Smooth
------------------------------	-----------------------

Description 9500 72" x 30" Cover	Detail Rev.
-------------------------------------	-------------

Part Number Numéro Pièce	Rev.	9
9500723024C	0	11

SEE BILL OF MATERIAL ON LAST PAGE

This drawing is confidential and must not be reproduced or used without the consent of EXM

Ce dessin est confidentiel et ne doit pas être reproduit ou utilisé sans le consentement de EXM

STANDARD FEATURES ARE NOT LISTED IN THIS HOLE TABLE			
HOLE TABLE - FRONT VIEW (CUSTOM FEATURE ONLY)			
CUT-OUT	XDIM	YDIM	DESCRIPTION
1	2.000	2.028	STUD M6 x 18mm (Inside)
2	2.000	32.628	STUD M6 x 18mm (Inside)
3	2.000	63.521	STUD M6 x 18mm (Inside)
4	25.407	2.028	STUD M6 x 18mm (Inside)
5	25.407	32.628	STUD M6 x 18mm (Inside)
6	25.407	63.521	STUD M6 x 18mm (Inside)
7	2.000	3.139	STUD M6 x 18mm (Inside)
8	2.000	62.409	STUD M6 x 18mm (Inside)
9	25.407	3.139	STUD M6 x 18mm (Inside)
10	25.407	62.409	STUD M6 x 18mm (Inside)
11	26.937	6.118	CLOSING BAR STUD (Inside)
12	26.937	59.430	CLOSING BAR STUD (Inside)
-----	-----	-----	-----
13	26.937	34.743	HANDLE 885 ESL2A-APHK @ 0.0°

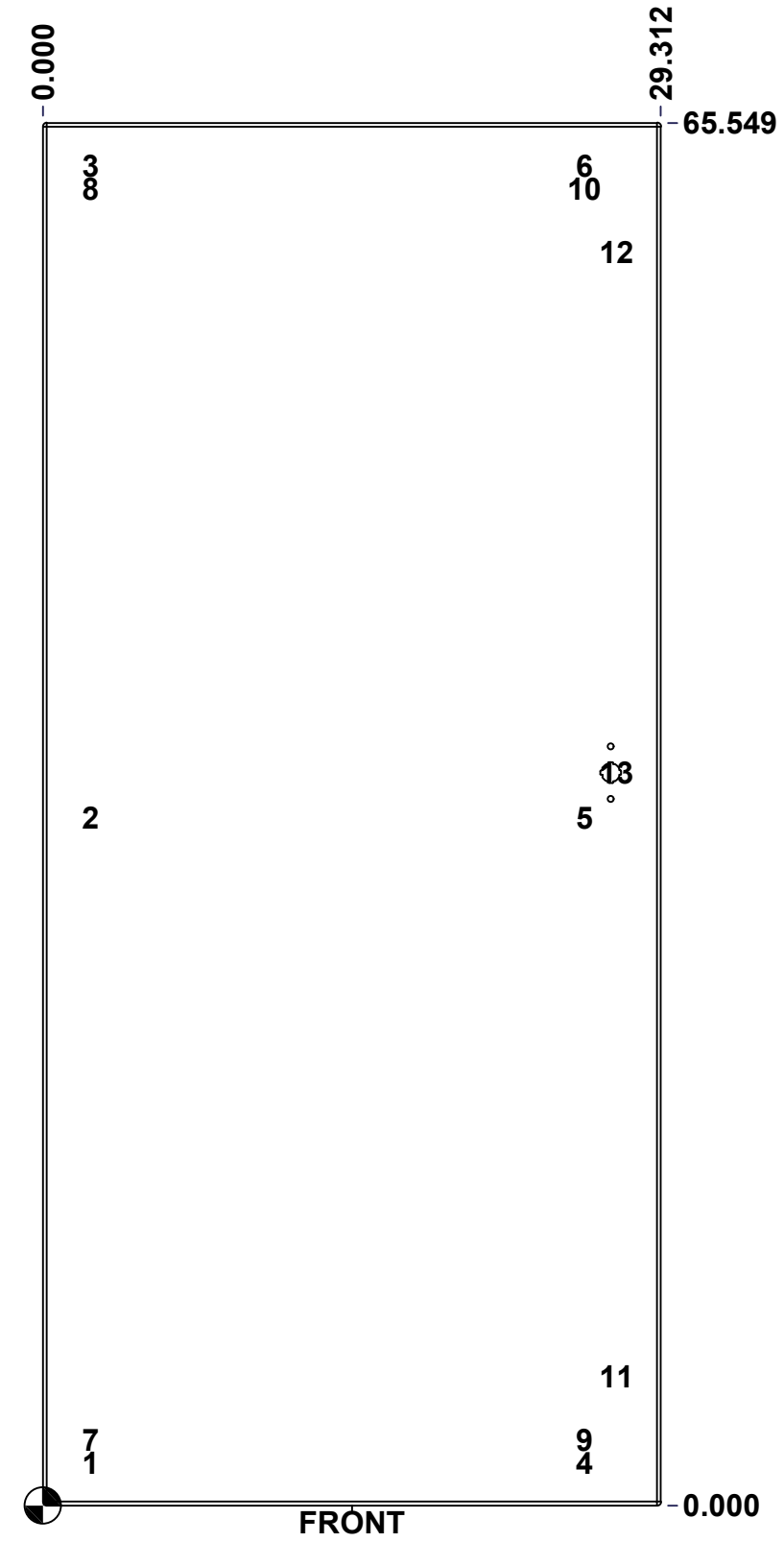

	Description	Status
	9500 72" x 30" Cover	(NULL)
	Part Number	Rev.
	Numéro Pièce	10
	9500723024C	0
		11

This drawing is confidential and must not be reproduced or used without the consent of EXM

Ce dessin est confidentiel et ne doit pas être reproduit ou utilisé sans le consentement de EXM

No.	Revisions	Date	By/Par

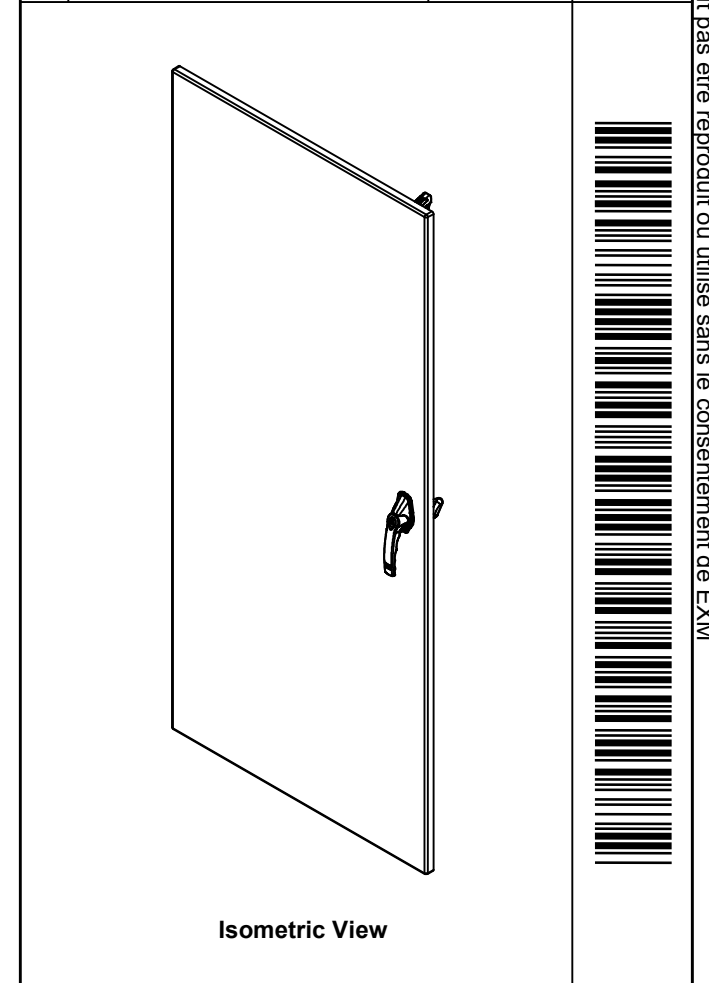

1	STK-Q-47527	1	9500 Lower Closing Bar 72"
1	STK-Q-47517	1	9500 Upper Closing Bar 72"
1	STK-A-03886-36	2	Gearbox Clockwise Assembly (36.0mm)
1	885ESL2A-APHK	6	885 ESL2A-APHK - Zinc Die Cast L-Handle Padlockable Assy
1	STK-P-02400S	0	Powder Paint (Asa-61 Grey / Smooth)
1	STK-S-00100	0	3.5" x 2" Silver Milar Flexcon Sticker
1	STK-K-10840	3	9500 - Door Stiffener Assembly
2	STK-Q-16410	0	Guide Stud - Largel (No Paint Cap Required)
10	STK-Q-16055	1	M6 x 18mm Stud (No Paint Cap Required)
1	9500723024G	0	9500 72" x 30" Cover Gasket
1	9500723024C-P	0	9500 72" x 30" Cover Part
2	STK-A-90025	0	9500 - Cabinet Closing Bar End (Large)
4	STK-K-09860	7	Cabinet Hinge with Captive Pins
QTY	Part Number	Rev	Description
Parts List			

	Tél: (450) 979-4373 Fax: (450) 979-4626 www.exmweb.com	Flatness Aplatissement Max 3.0mm
	Projection 	Customer Client
Drawn By Dessiné Par	BoxCad: BoxCad	Date 11-Sep-14
Material Matière	12 Ga Cold Rolled A1008 CS Type B (2.5mm)	
Color Couleur	Asa-61 Grey	Finish Fini Smooth
Description 9500 72" x 30" Cover		Detail Rev.
Part Number Numéro Pièce 9500723024C		Rev. 11 0

All knockouts are actual size / Les disques défonçables sont grandeur réel
 All dimensions are before paint / Toutes les dimensions sont avant peinture

This drawing is confidential and must not be reproduced or used without the consent of EXM

Ce dessin est confidentiel et ne doit pas être reproduit ou utilisé sans le consentement de EXM

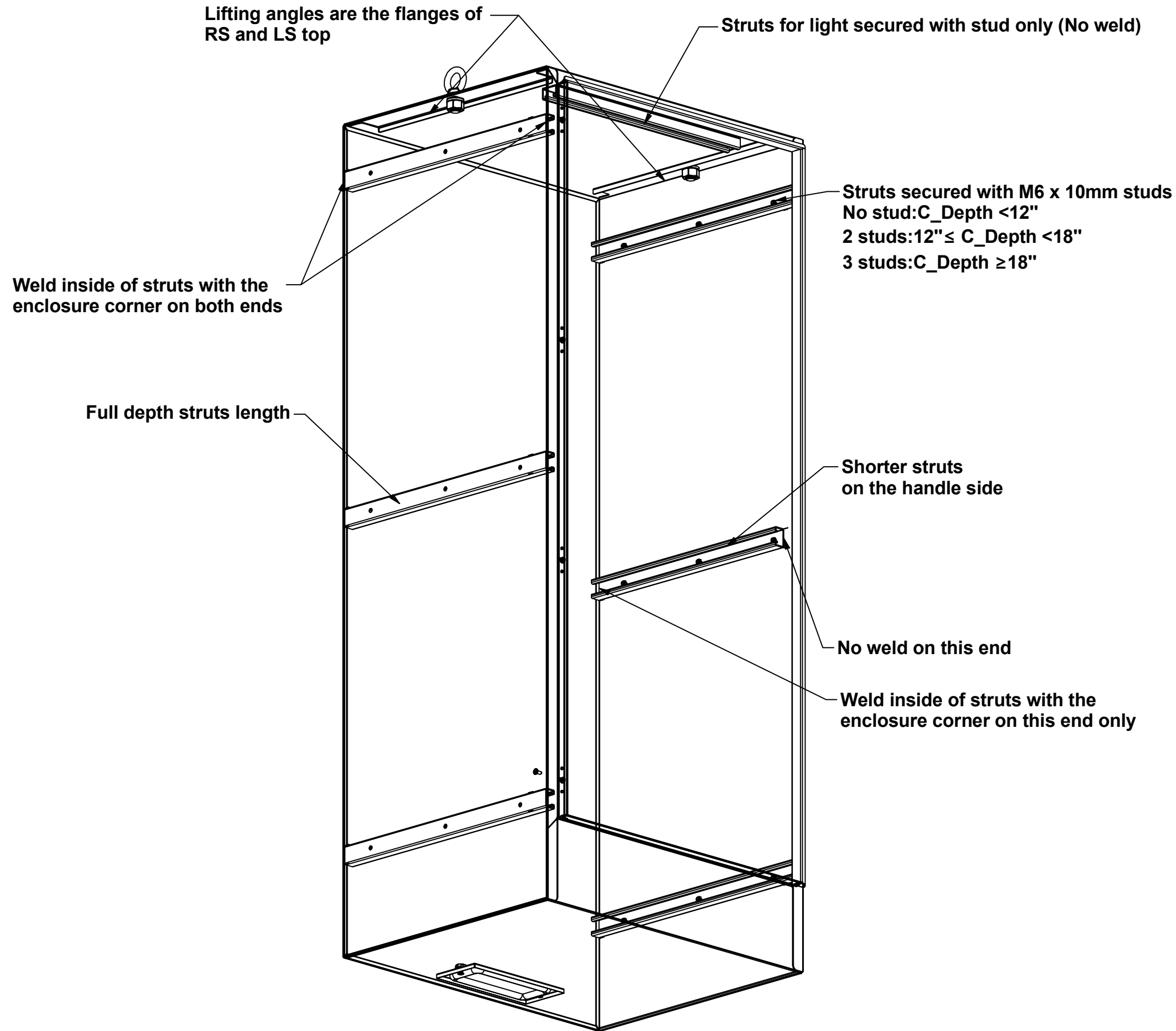

No.	Revisions	Date	By/Par

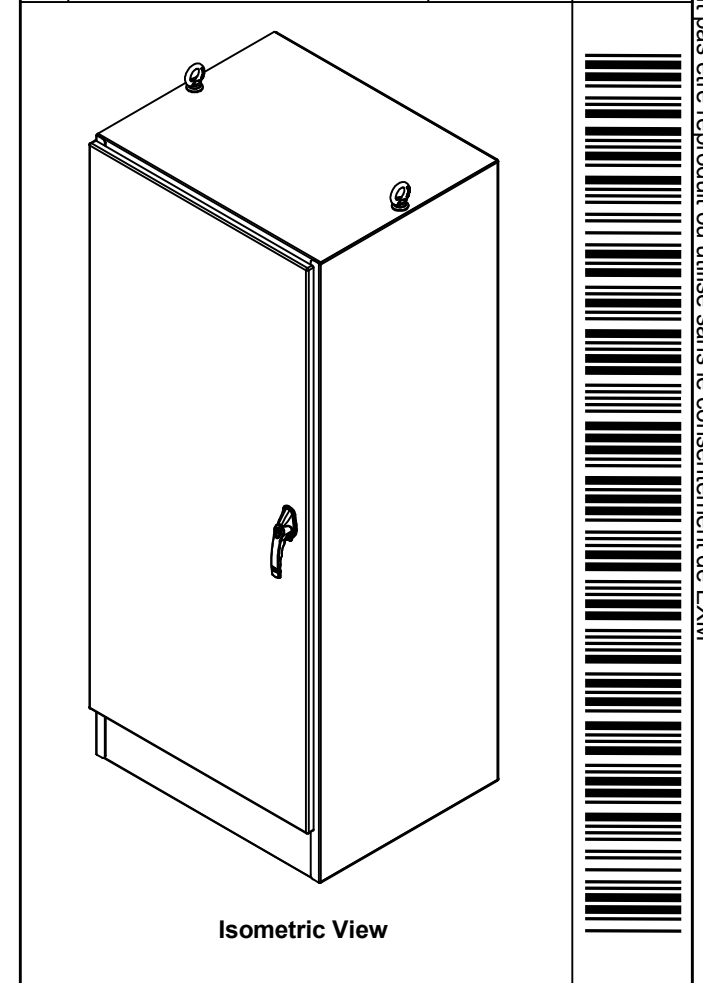

Tél: (450) 979-4373 Fax: (450) 979-4626 www.exmweb.com		Flatness Aplatissement
		Max 3.0mm
Customer Client		Date
Drawn By Dessiné Par PatrickD		Date 3/9/2020
Material Matière N/A		
Color Couleur N/A	Finish Fini N/A	
Description 9500 Welding Detail		Detail Rev.
Part Number Numéro Pièce 9500_WELDING_DETAIL		Rev. 1
		0 / 1