

This drawing is confidential and must not be reproduced or used without the consent of EXM

Ce dessin est confidentiel et ne doit pas être reproduit ou utilisé sans le consentement de EXM

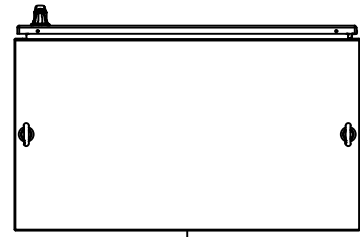

TOP

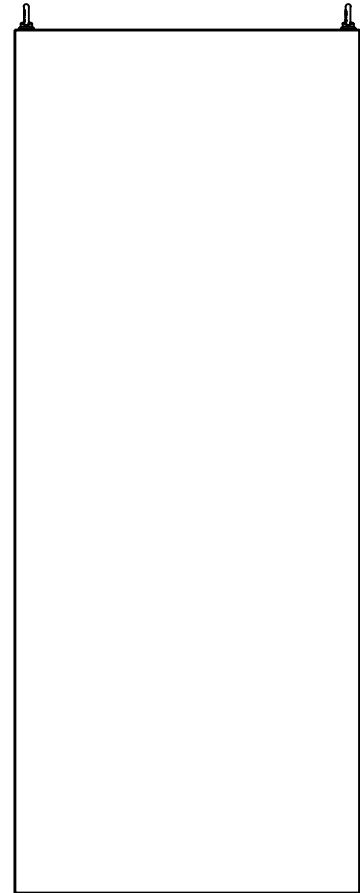

BACK

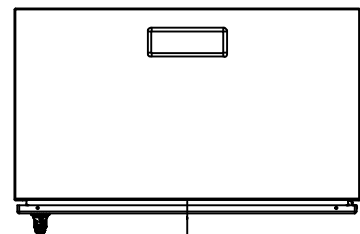

BOTTOM

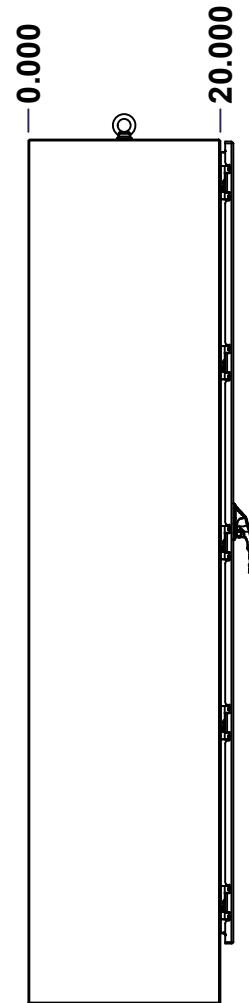

LEFT

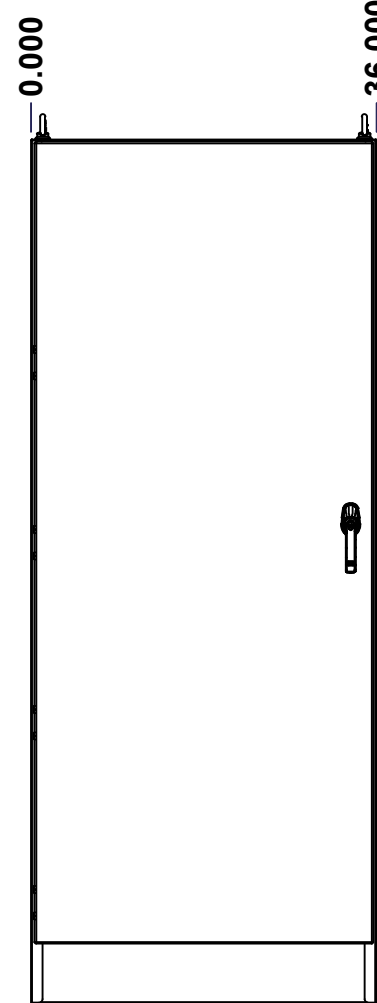

FRONT

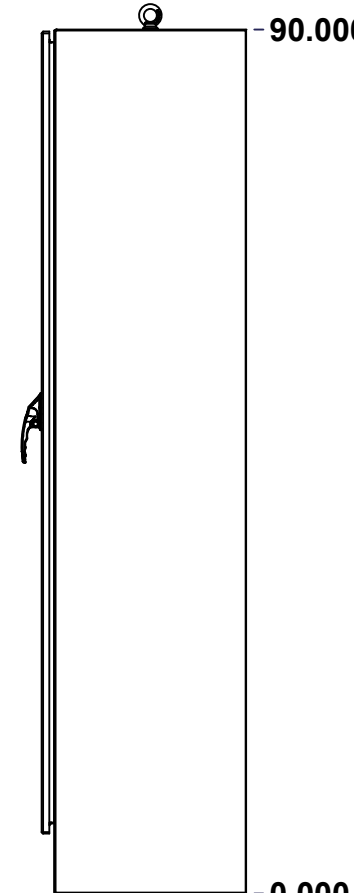

RIGHT

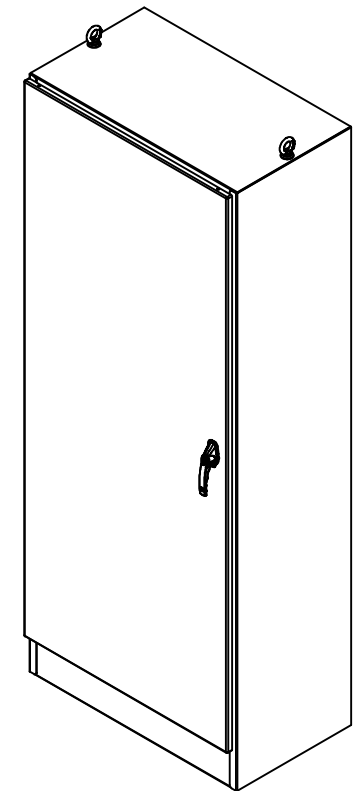

Isometric View

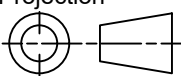

No.	Revisions	Date	By/Par

 Tél: (450) 979-4373 Fax: (450) 979-4626 www.exmweb.com		Flatness Aplatissement Max 3.0mm Projection 
Customer Client	Date	
Drawn By Dessiné Par	BoxCad: BoxCad	Date 12-Sep-14
Material Matière	12 Ga Cold Rolled A1008 CS Type B (2.5mm)	
Color Couleur	Asa-61 Grey	Finish Fini Smooth
Description	Detail Rev.	
9500 90" x 36" x 20" Assembly		
Part Number Numéro Pièce	Rev. 0	1 / 11

SEE BILL OF MATERIAL ON LAST PAGE

9500903620

This drawing is confidential and must not be reproduced or used without the consent of EXM

Ce dessin est confidentiel et ne doit pas être reproduit ou utilisé sans le consentement de EXM

NOTE	
ITEM	DESCRIPTION
1	NEMA 12/13 Enclosure
2	C/W Standard ground studs on box and cover
3	C/W Standard door stiffener
4	W/O Inner panel
5	C/W Standard inner panel mounting struts
6	C/W Eyebolts
7	C/W Struts installed (Included)

No.	Revisions	Date	By/Par

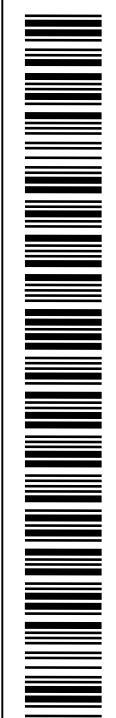
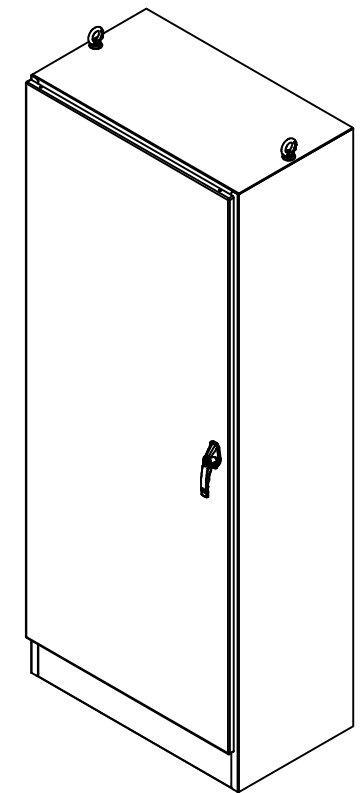

Isometric View

PACKING		
ITEM	QTY	DESCRIPTION
Cardboard sleeve	2	Top and Bottom
Cardboard strip	2	Between back of enclosure and inner panel
Plastic bag	1	To protect cover surface and inside gasket
Cardboard corner	4	To reinforced for the plastic strap tightening
Plastic strap - Black	2	To Squeeze 2 cardboard sleeve together
Packaging label	3	White label with PN
Plastic strap- Green	2	To secure the enclosure to the wood pallet
Wood Pallet	1	2" deeper and 3" larger than enclosure size

Qty	Part Number	Rev	Description
1	9500903620GP	0	9500 Gland Plate
1	880EB14	2	Eye Bolt M14 (Pack of 2)
1	9500903620C	0	9500 90" x 36" Cover
1	9500903620B	0	9500 90" x 36" x 20" Body
5	STK-Q-04050-10	8	M6 x 10mm Hexagon Socket Head Machine Screw with Nyseal
Parts List			

		Flatness Aplatissement Max 3.0mm	
Tél: (450) 979-4373 Fax: (450) 979-4626 www.exmweb.com		Projection 	
Customer Client		Date	
Drawn By Dessiné Par BoxCad: BoxCad		Date 12-Sep-14	
Material Matière 12 Ga Cold Rolled A1008 CS Type B (2.5mm)			
Color Couleur Asa-61 Grey		Finish Fini Smooth	
Description 9500 90" x 36" x 20" Assembly			Detail Rev.
Part Number Numéro Pièce 9500903620		Rev. 0	2 / 11

This drawing is confidential and must not be reproduced or used without the consent of EXM

Ce dessin est confidentiel et ne doit pas être reproduit ou utilisé sans le consentement de EXM

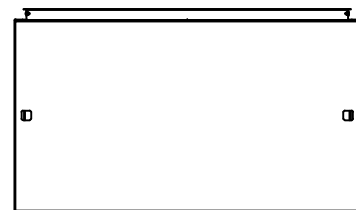

TOP

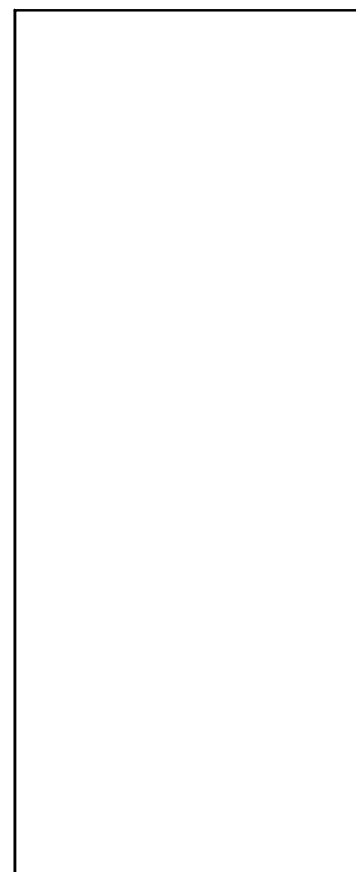

BACK

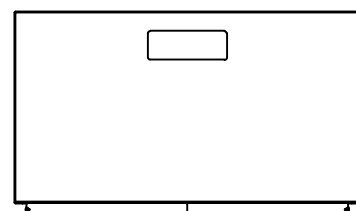

BOTTOM

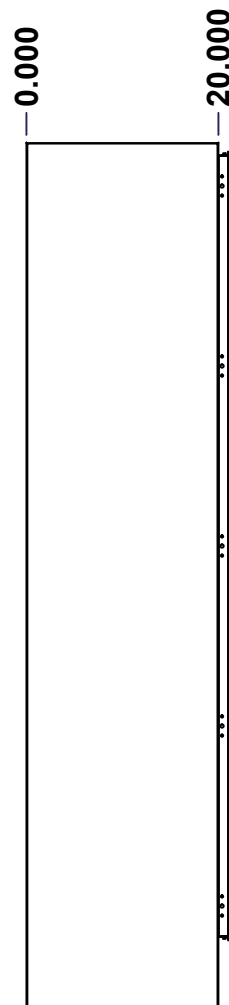

LEFT

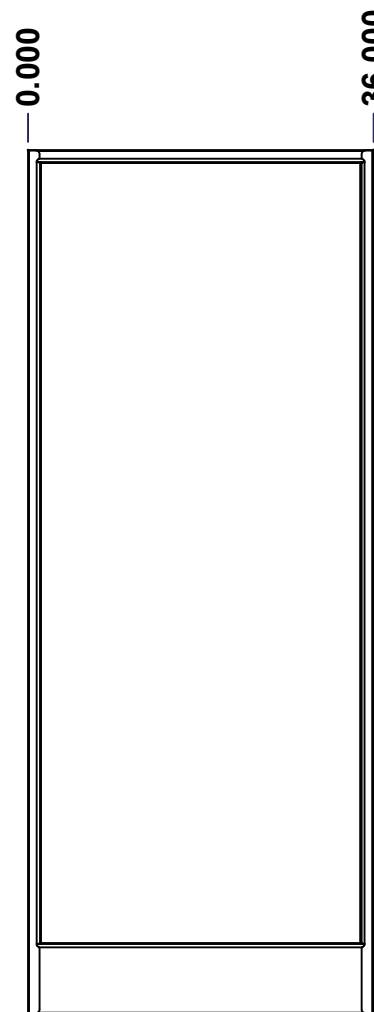

FRONT

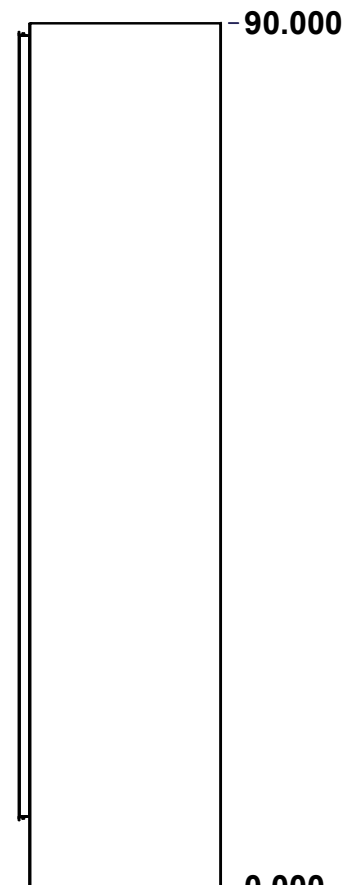

RIGHT

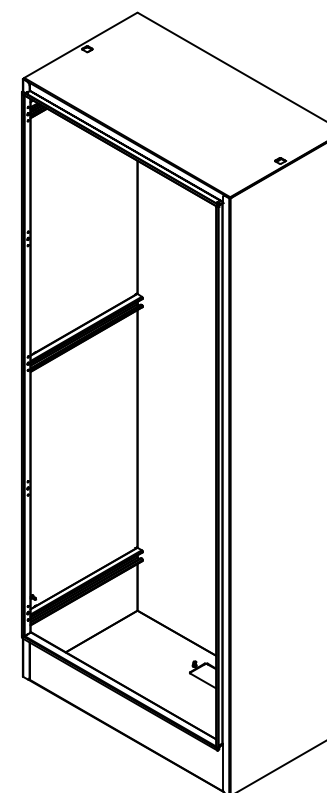

Isometric View

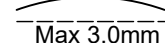
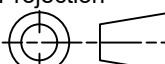

No.	Revisions	Date	By/Par

 Tél: (450) 979-4373 Fax: (450) 979-4626 www.exmweb.com		Flatness Aplatissement  Max 3.0mm Projection 
Customer Client	Date	
Drawn By Dessiné Par	BoxCad: BoxCad	Date 12-Sep-14
Material Matière	12 Ga Cold Rolled A1008 CS Type B (2.5mm)	
Color Couleur	Asa-61 Grey	Finish Fini Smooth
Description	Detail Rev.	
9500 90" x 36" x 20" Body		
Part Number Numéro Pièce	Rev.	3
9500903620B	0	11

SEE BILL OF MATERIAL ON LAST PAGE

This drawing is confidential and must not be reproduced or used without the consent of EXM

Ce dessin est confidentiel et ne doit pas être reproduit ou utilisé sans le consentement de EXM

STANDARD FEATURES ARE NOT LISTED IN THIS HOLE TABLE			
HOLE TABLE - TOP VIEW (CUSTOM FEATURE ONLY)			
CUT-OUT	XDIM	YDIM	DESCRIPTION
1	17.911	15.911	Struts CR400 27.500" (Inside)
2	17.911	15.911	STUDS M6 x 10mm (Inside)
3	7.161	15.911	STUDS M6 x 10mm (Inside)
4	28.661	15.911	STUDS M6 x 10mm (Inside)

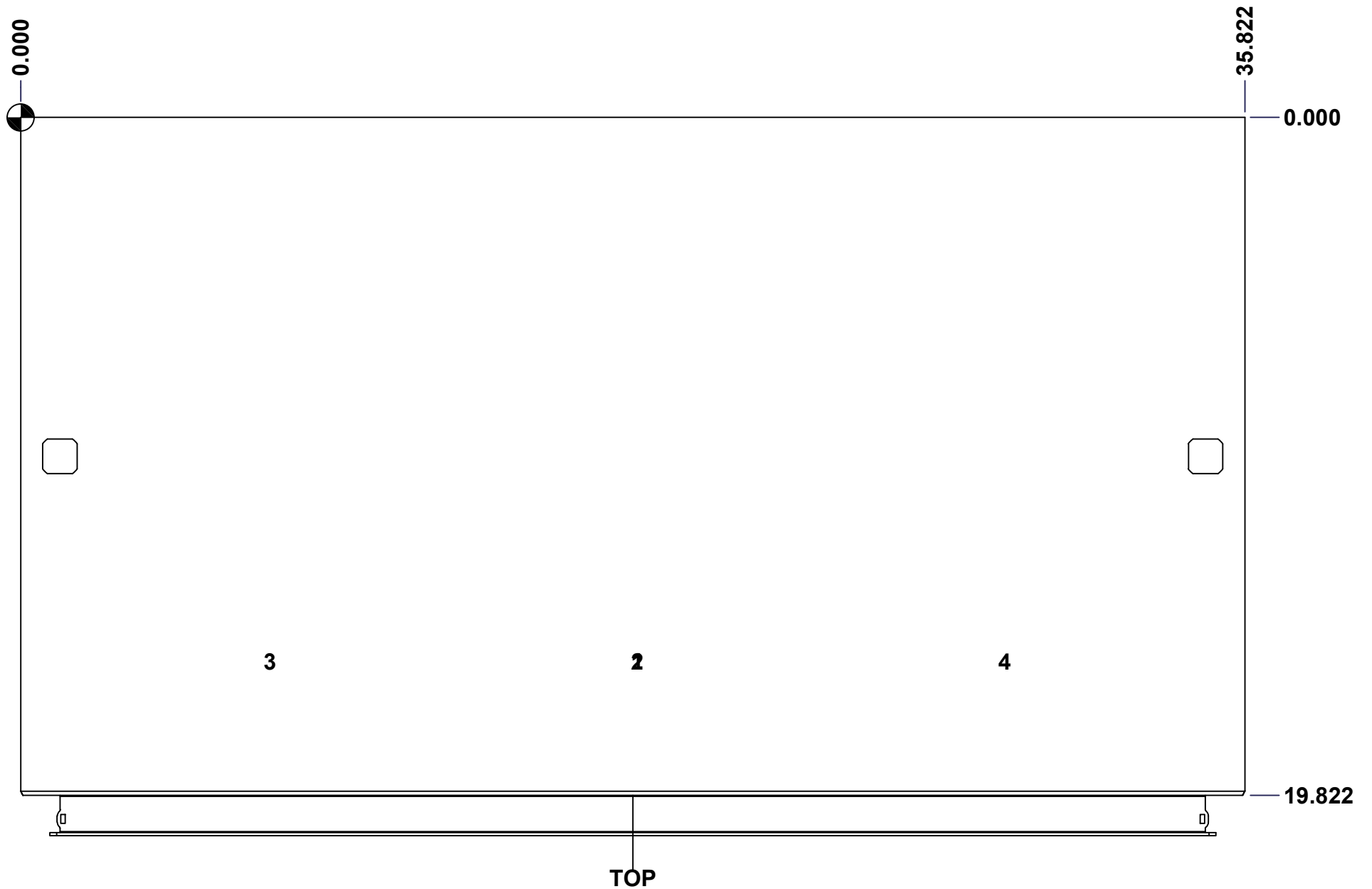

	Description	Status
	9500 90" x 36" x 20" Body	(NULL)
	Part Number Numéro Pièce	Rev.
	9500903620B	0
		4
		11

This drawing is confidential and must not be reproduced or used without the consent of EXM

Ce dessin est confidentiel et ne doit pas être reproduit ou utilisé sans le consentement de EXM

STANDARD FEATURES ARE NOT LISTED IN THIS HOLE TABLE

HOLE TABLE - RIGHT VIEW (CUSTOM FEATURE ONLY)

CUT-OUT	XDIM	YDIM	DESCRIPTION
1	3.161	85.036	STUDS M6 x 10mm (Inside)
2	16.661	85.036	STUDS M6 x 10mm (Inside)
3	9.911	85.036	STUDS M6 x 10mm (Inside)
4	3.161	8.786	STUDS M6 x 10mm (Inside)
5	16.661	8.786	STUDS M6 x 10mm (Inside)
6	9.911	8.786	STUDS M6 x 10mm (Inside)
7	3.161	46.911	STUDS M6 x 10mm (Inside)
8	16.661	46.911	STUDS M6 x 10mm (Inside)
9	9.911	46.911	STUDS M6 x 10mm (Inside)

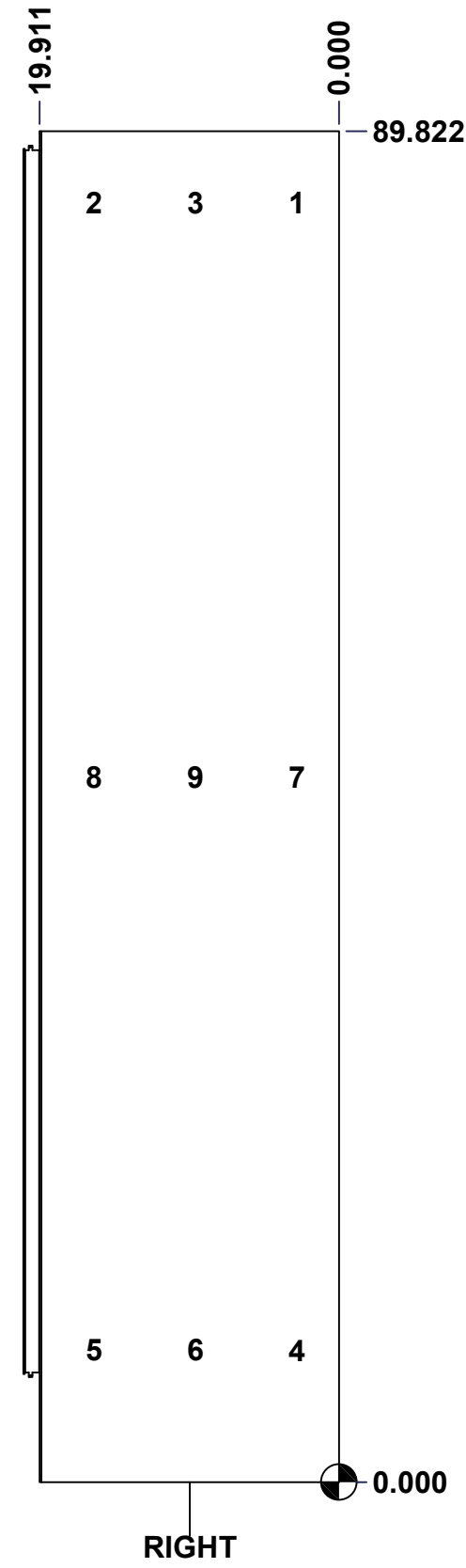

	Description 9500 90" x 36" x 20" Body	Status (NULL)
	Part Number Numéro Pièce 9500903620B	Rev. 5 0

This drawing is confidential and must not be reproduced or used without the consent of EXM

Ce dessin est confidentiel et ne doit pas être reproduit ou utilisé sans le consentement de EXM

STANDARD FEATURES ARE NOT LISTED IN THIS HOLE TABLE			
HOLE TABLE - BOTTOM VIEW (CUSTOM FEATURE ONLY)			
CUT-OUT	XDIM	YDIM	DESCRIPTION
1	13.286	3.411	GP STUD M6 x 16mm (Inside)
2	22.536	3.411	GP STUD M6 x 16mm (Inside)

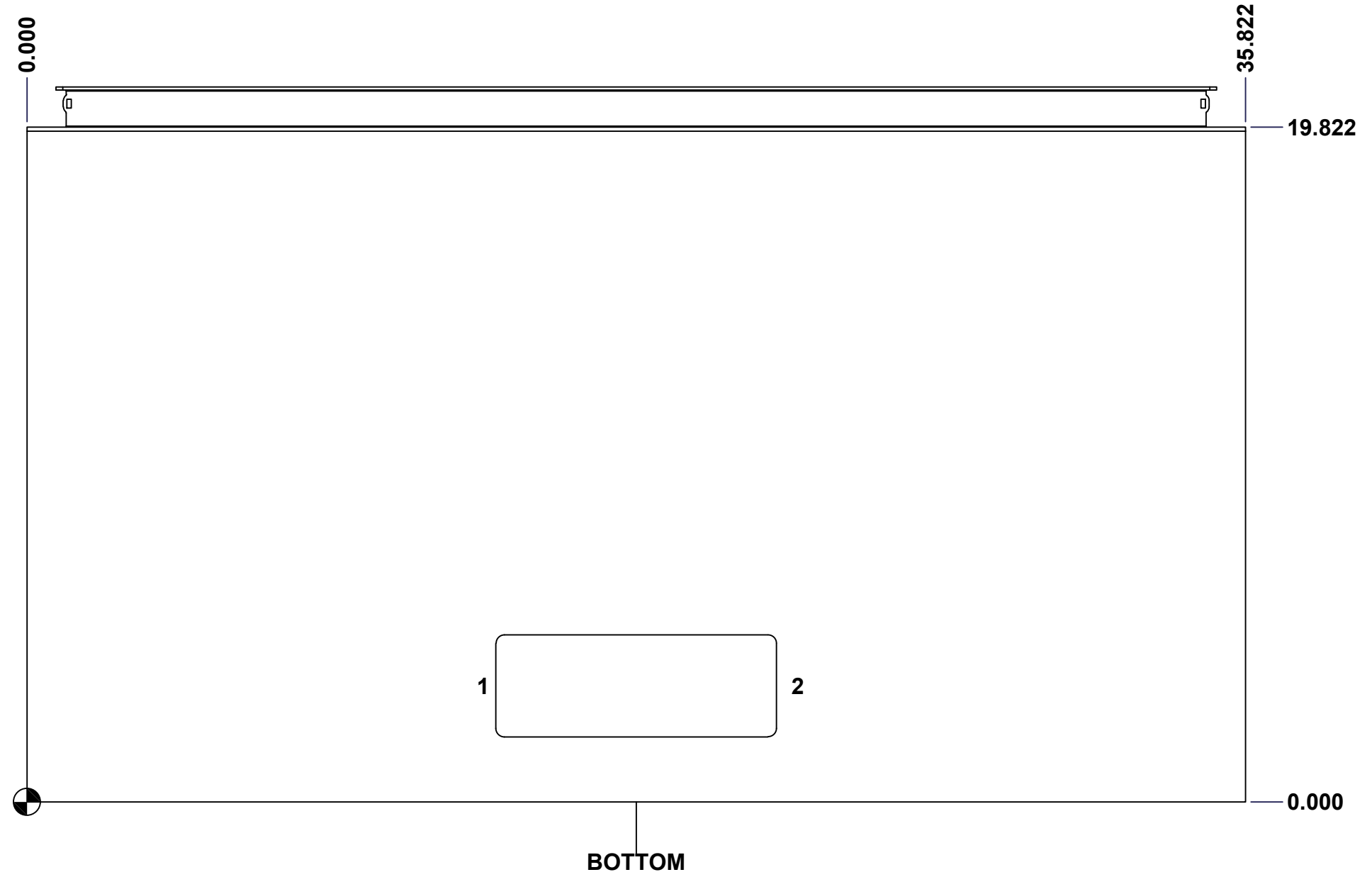

	Description	Status
	9500 90" x 36" x 20" Body	(NULL)
	Part Number Numéro Pièce	Rev.
	9500903620B	0 / 6
		11

This drawing is confidential and must not be reproduced or used without the consent of EXM

Ce dessin est confidentiel et ne doit pas être reproduit ou utilisé sans le consentement de EXM

STANDARD FEATURES ARE NOT LISTED IN THIS HOLE TABLE

HOLE TABLE - LEFT VIEW (CUSTOM FEATURE ONLY)

CUT-OUT	XDIM	YDIM	DESCRIPTION
1	18.411	11.286	GND STUD M6 x 16mm (Inside)
2	3.161	85.036	STUDS M6 x 10mm (Inside)
3	16.661	85.036	STUDS M6 x 10mm (Inside)
4	9.911	85.036	STUDS M6 x 10mm (Inside)
5	3.161	8.786	STUDS M6 x 10mm (Inside)
6	16.661	8.786	STUDS M6 x 10mm (Inside)
7	9.911	8.786	STUDS M6 x 10mm (Inside)
8	3.161	46.911	STUDS M6 x 10mm (Inside)
9	16.661	46.911	STUDS M6 x 10mm (Inside)
10	9.911	46.911	STUDS M6 x 10mm (Inside)

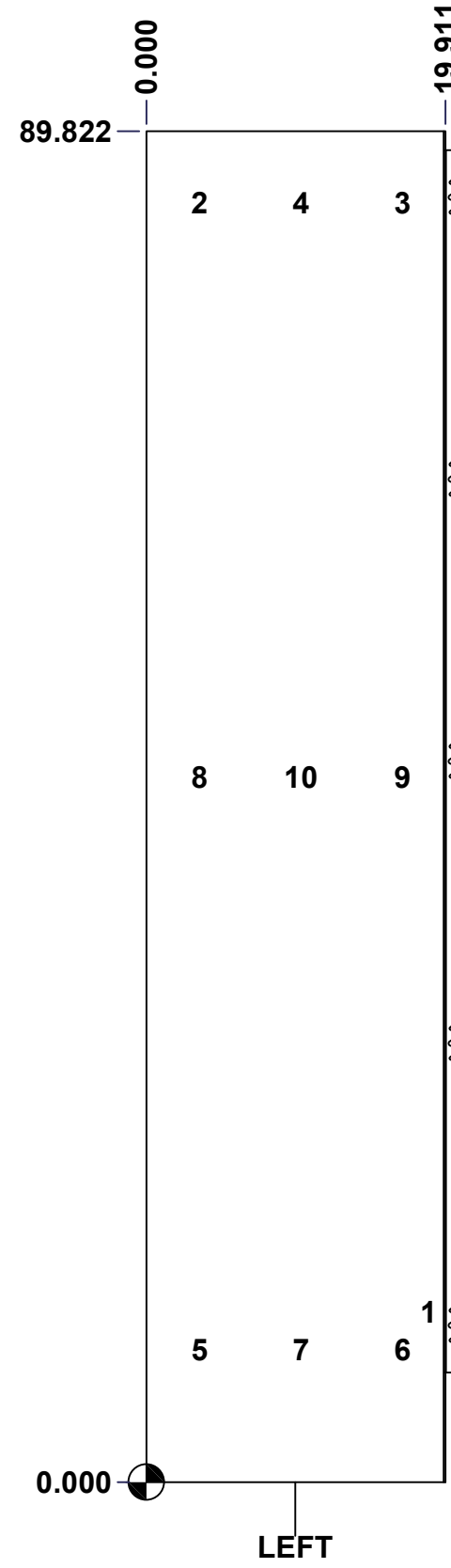

	Description	Status	
	9500 90" x 36" x 20" Body	(NULL)	
	Part Number Numéro Pièce	Rev.	7
	9500903620B	0	11

This drawing is confidential and must not be reproduced or used without the consent of EXM

Ce dessin est confidentiel et ne doit pas être reproduit ou utilisé sans le consentement de EXM

No.	Revisions	Date	By/Par

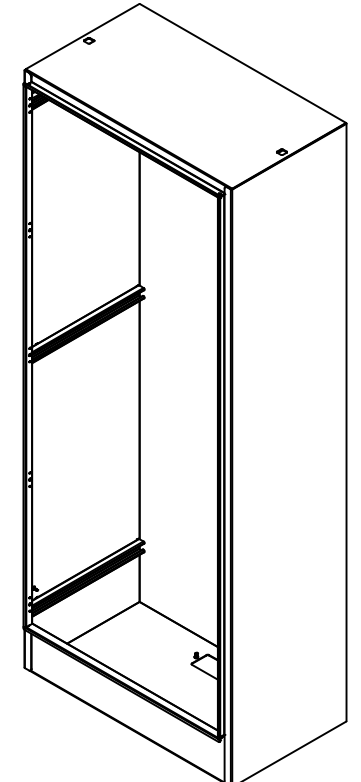

Isometric View

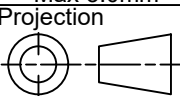

Qty	Part Number	Rev	Description
21	STK-Q-16030	0	Stud M6 x 10mm Steel
1	CR400MS_27.5	0	Commercial Roll Mild Steel (27.5in long)
2	STK-Q-74910	0	Eyebolt Lifting Angle (15.500")
1	STK-P-02400S	0	Powder Paint (Asa-61 Grey / Smooth)
1	STK-Q-52200-20	0	Sasco Strut S5 (17.500" Long)
5	STK-Q-52250-20	0	Sasco Strut S5 (19.500" Long)
1	9500903620BT-P	0	9500 36" x 20" Bottom Part
1	9500903620T-P	0	9500 36" x 20" Top Part
1	9500903620RS-P	0	9500 90" x 36" Right Part
1	9500903620LS-P	0	9500 90" x 36" Left Part
1	9500903620B-P	0	9500 90" x 36" Back Part
21	STK-Q-07220	1	M6 Nylon Insert Lock Nut
3	STK-Q-16080	0	Ground Stud M6 x 16mm Steel

 Tél: (450) 979-4373 Fax: (450) 979-4626 www.exmweb.com		Flatness Aplatissement Max 3.0mm
Projection 		Customer Client
Drawn By Dessiné Par BoxCad: BoxCad		Date 12-Sep-14
Material Matière 12 Ga Cold Rolled A1008 CS Type B (2.5mm)		
Color Couleur Asa-61 Grey	Finish Fini Smooth	
Description 9500 90" x 36" x 20" Body		Detail Rev.
Part Number Numéro Pièce 9500903620B		Rev. 8 0

This drawing is confidential and must not be reproduced or used without the consent of EXM

Ce dessin est confidentiel et ne doit pas être reproduit ou utilisé sans le consentement de EXM

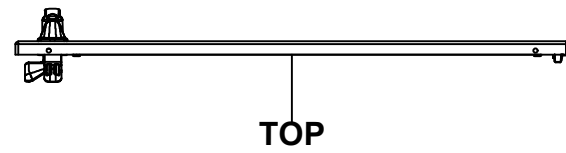

TOP

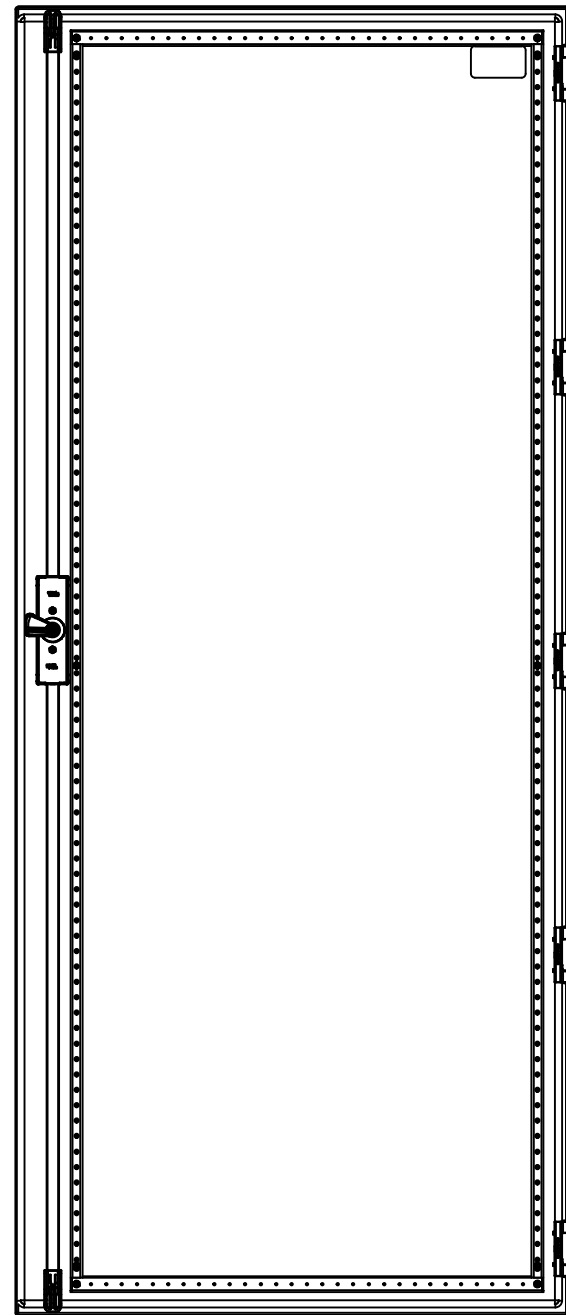

BACK



BOTTOM

0.000
0.835



LEFT

0.000

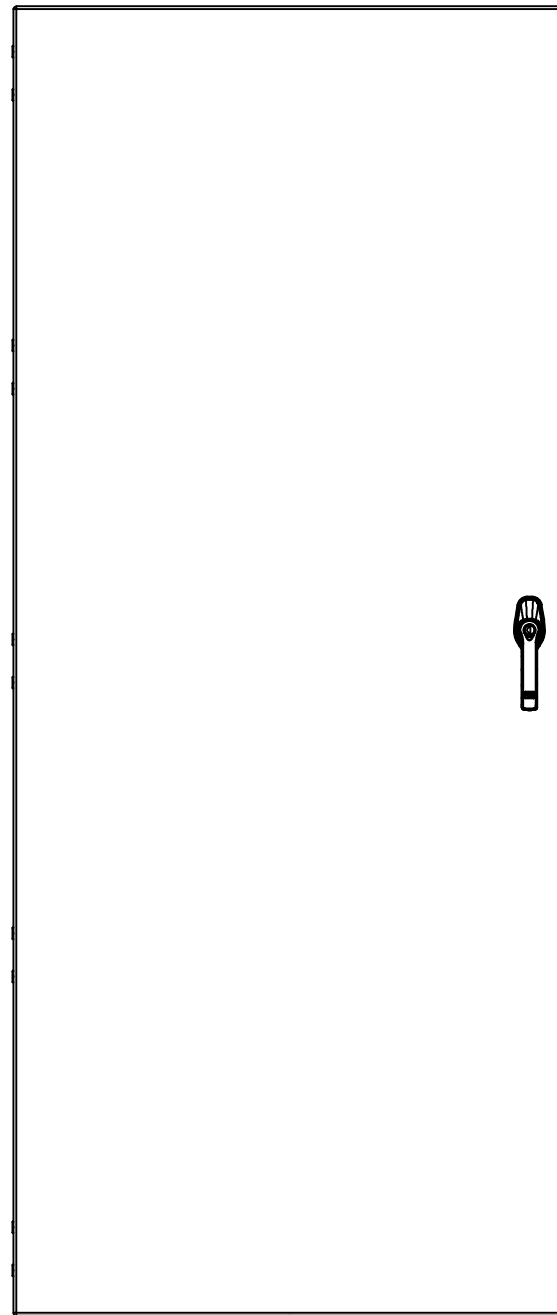

FRONT

35.312

83.549



RIGHT

0.000

No.	Revisions	Date	By/Par

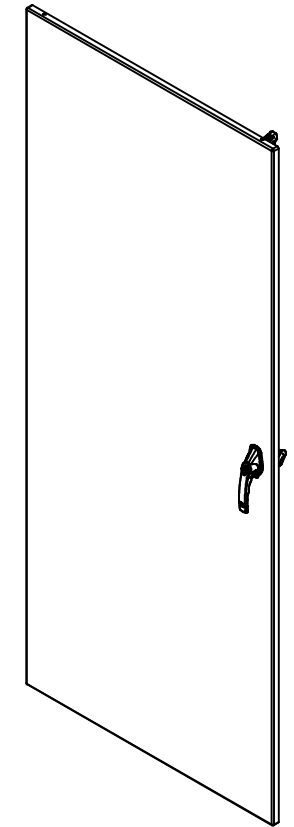

Isometric View



Tél: (450) 979-4373
Fax: (450) 979-4626
www.exmweb.com

Flatness
Aplatissement

Max 3.0mm

Projection

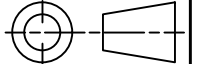

Customer Client	Date
Drawn By Dessiné Par BoxCad: BoxCad	Date 12-Sep-14
Material Matière 12 Ga Cold Rolled A1008 CS Type B (2.5mm)	

Color Couleur Asa-61 Grey	Finish Fini Smooth
------------------------------	-----------------------

Description 9500 90" x 36" Cover	Detail Rev.
-------------------------------------	-------------

Part Number Numéro Pièce 9500903620C	Rev. 0	9
---	--------	---

SEE BILL OF MATERIAL ON LAST PAGE

This drawing is confidential and must not be reproduced or used without the consent of EXM

Ce dessin est confidentiel et ne doit pas être reproduit ou utilisé sans le consentement de EXM

STANDARD FEATURES ARE NOT LISTED IN THIS HOLE TABLE			
HOLE TABLE - FRONT VIEW (CUSTOM FEATURE ONLY)			
CUT-OUT	XDIM	YDIM	DESCRIPTION
1	2.000	2.028	STUD M6 x 18mm (Inside)
2	2.000	41.486	STUD M6 x 18mm (Inside)
3	2.000	81.521	STUD M6 x 18mm (Inside)
4	31.407	2.028	STUD M6 x 18mm (Inside)
5	31.407	41.486	STUD M6 x 18mm (Inside)
6	31.407	81.521	STUD M6 x 18mm (Inside)
7	2.000	3.139	STUD M6 x 18mm (Inside)
8	2.000	80.409	STUD M6 x 18mm (Inside)
9	31.407	3.139	STUD M6 x 18mm (Inside)
10	31.407	80.409	STUD M6 x 18mm (Inside)
11	32.937	6.118	CLOSING BAR STUD (Inside)
12	32.937	77.430	CLOSING BAR STUD (Inside)
-----	-----	-----	-----
13	32.937	43.743	HANDLE 885 ESL2A-APHK @ 0.0°

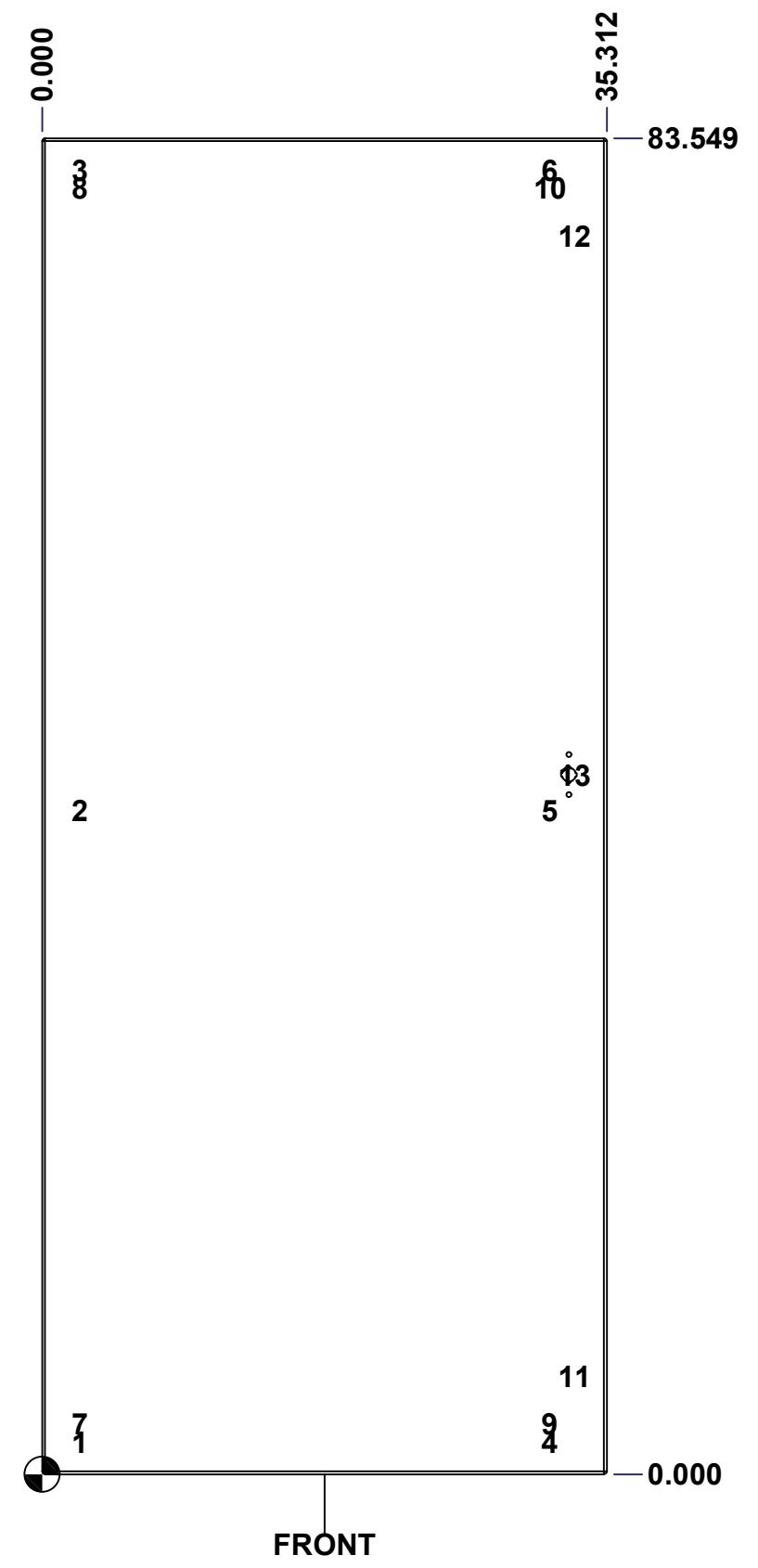

	Description	Status	
	9500 90" x 36" Cover	(NULL)	
	Part Number Numéro Pièce	Rev.	10
	9500903620C	0	11

This drawing is confidential and must not be reproduced or used without the consent of EXM

Ce dessin est confidentiel et ne doit pas être reproduit ou utilisé sans le consentement de EXM

No.	Revisions	Date	By/Par

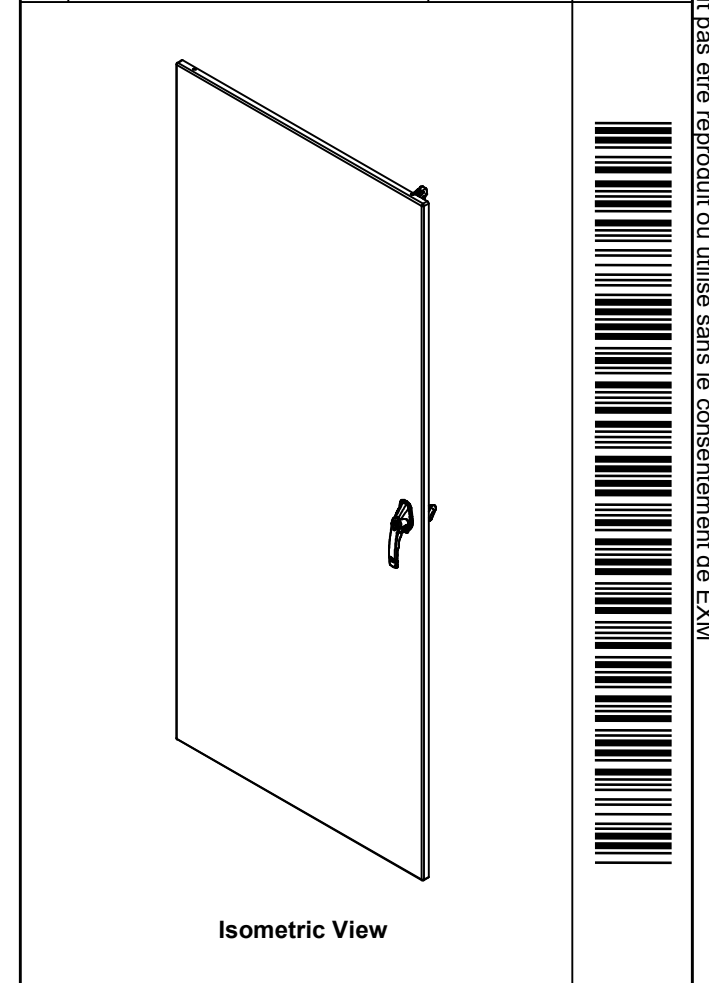

Qty	Part Name	Rev	Description
1	STK-Q-47528	1	9500 Lower Closing Bar 90"
1	STK-Q-47518	1	9500 Upper Closing Bar 90"
1	STK-A-03886-36	2	Gearbox Clockwise Assembly (36.0mm)
1	885ESL2A-APHK	6	885 ESL2A-APHK - Zinc Die Cast L-Handle Padlockable Assy
1	STK-P-02400S	0	Powder Paint (Asa-61 Grey / Smooth)
1	STK-S-00100	0	3.5" x 2" Silver Milar Flexcon Sticker
1	STK-K-10880	3	9500 - Door Stiffener Assembly
1	9500903620G	0	9500 90" x 36" Cover Gasket
2	STK-Q-16410	0	Guide Stud - Largel (No Paint Cap Required)
10	STK-Q-16055	1	M6 x 18mm Stud (No Paint Cap Required)
1	9500903620C-P	0	9500 90" x 36" Cover Part
5	STK-K-09860	7	Cabinet Hinge with Captive Pins
2	STK-A-90025	0	9500 - Cabinet Closing Bar End (Large)
Qty	Part Name	Rev	Description
Parts List			

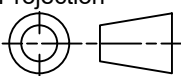
 Tél: (450) 979-4373 Fax: (450) 979-4626 www.exmweb.com		Flatness Aplatissement Max 3.0mm
Projection 		Date 12-Sep-14
Customer Client	BoxCad: BoxCad	Date
Drawn By Dessiné Par	Material Matière	Detail Rev.
Color Couleur	Finish Fini	Part Number Numéro Pièce
Asa-61 Grey	Smooth	9500903620C
Description 9500 90" x 36" Cover		Rev. 11 0

All knockouts are actual size / Les disques défonçables sont grandeur réel
 All dimensions are before paint / Toutes les dimensions sont avant peinture

This drawing is confidential and must not be reproduced or used without the consent of EXM

Ce dessin est confidentiel et ne doit pas être reproduit ou utilisé sans le consentement de EXM

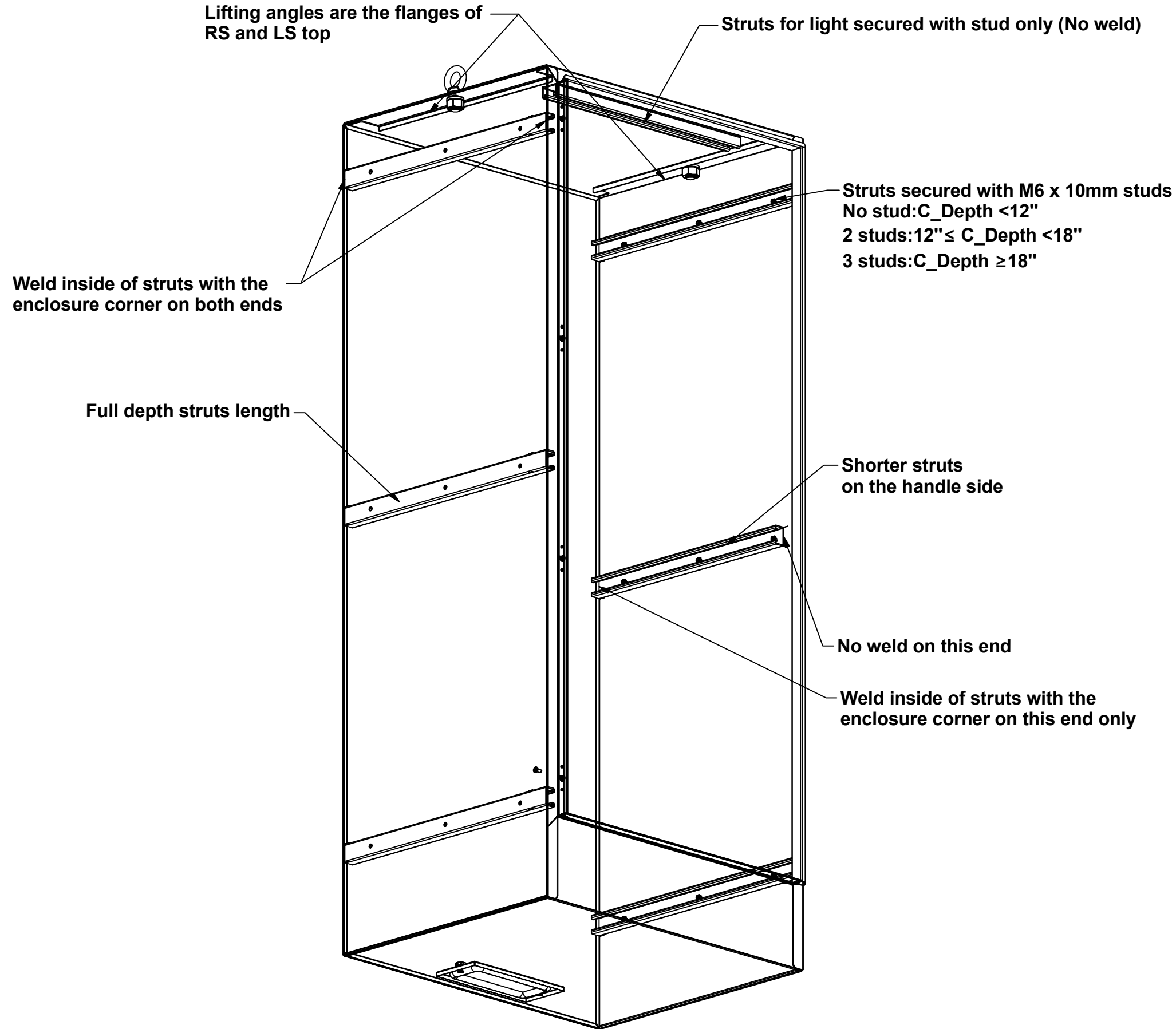

No.	Revisions	Date	By/Par

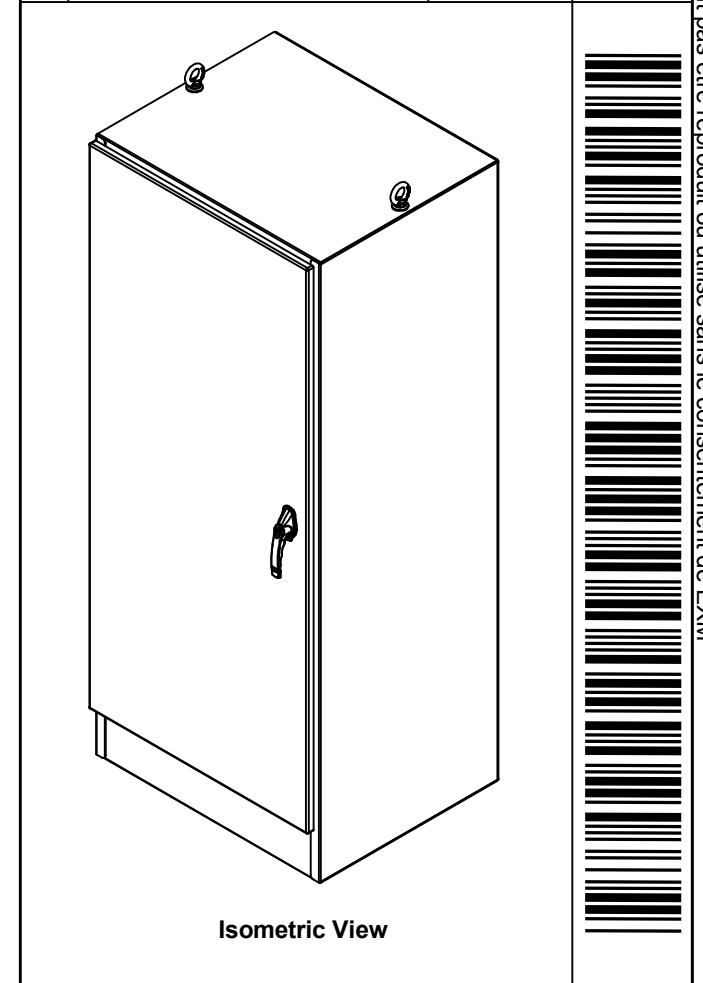

Tél: (450) 979-4373 Fax: (450) 979-4626 www.exmweb.com		Flatness Aplatissement
		Max 3.0mm
Customer Client		Date
Drawn By Dessiné Par PatrickD		Date 3/9/2020
Material Matière N/A		
Color Couleur N/A	Finish Fini N/A	
Description 9500 Welding Detail		Detail Rev.
Part Number Numéro Pièce 9500_WELDING_DETAIL		Rev. 1
		0 / 1