

This drawing is confidential and must not be reproduced or used without the consent of EXM

Ce dessin est confidentiel et ne doit pas être reproduit ou utilisé sans le consentement de EXM

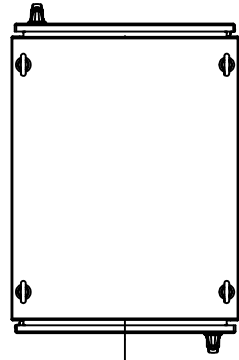

TOP

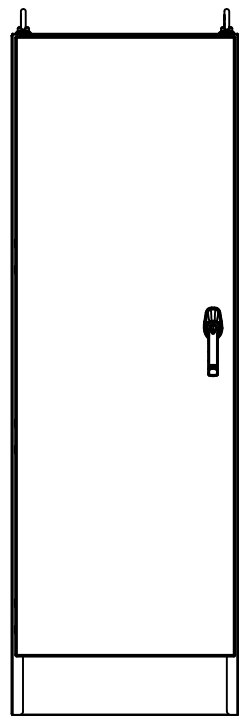

BACK

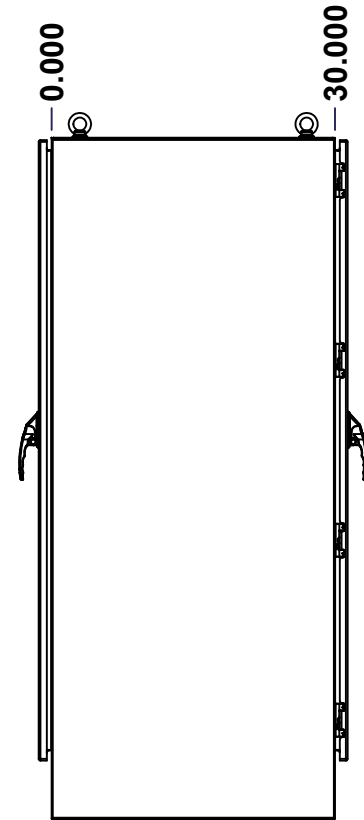

LEFT

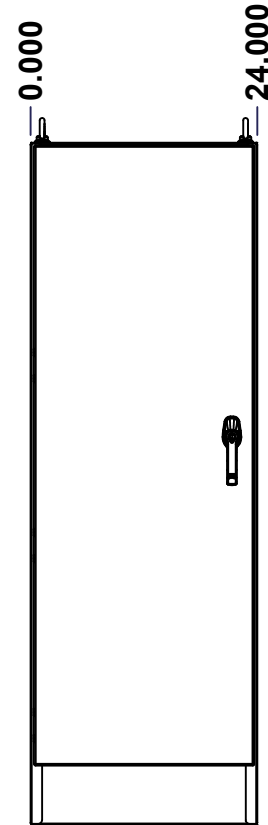

FRONT

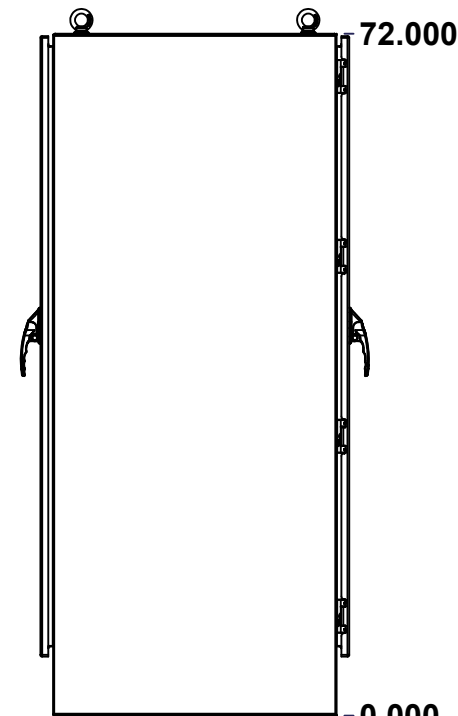

RIGHT

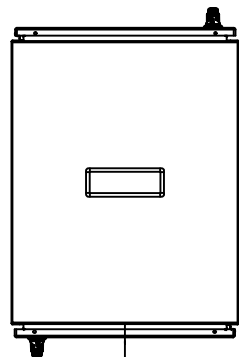

BOTTOM

No.	Revisions	Date	By/Par

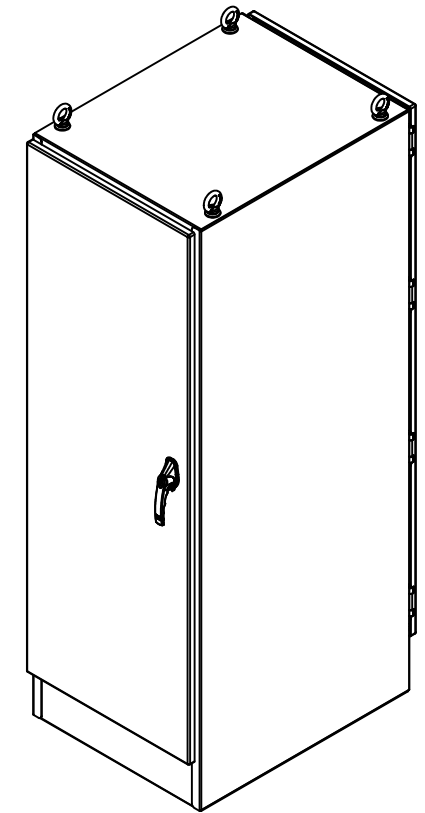

Isometric View



Tél: (450) 979-4373
 Fax: (450) 979-4626
www.exmweb.com

Flatness
Aplatissement

Max 3.0mm

Projection

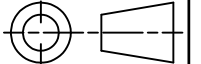

Customer Client	Date
Drawn By Dessiné Par BoxCad: BoxCad	Date 28-Oct-14
Material Matière 12 Ga Cold Rolled A1008 CS Type B (2.5mm)	
Color Couleur Asa-61 Grey	Finish Fini Smooth
Description 9500DA 72" x 24" x 30" Assembly	Detail Rev.
Part Number Numéro Pièce 9500DA722430	Rev. 1 0

SEE BILL OF MATERIAL ON LAST PAGE

This drawing is confidential and must not be reproduced or used without the consent of EXM

Ce dessin est confidentiel et ne doit pas être reproduit ou utilisé sans le consentement de EXM

NOTE	
ITEM	DESCRIPTION
1	NEMA 12/13 Enclosure
2	C/W Standard ground studs on box and cover
3	C/W Standard door stiffener
4	W/O Inner panel
5	C/W Standard inner panel mounting struts
6	C/W Eyebolts
7	C/W Struts installed (Included)

No.	Revisions	Date	By/Par

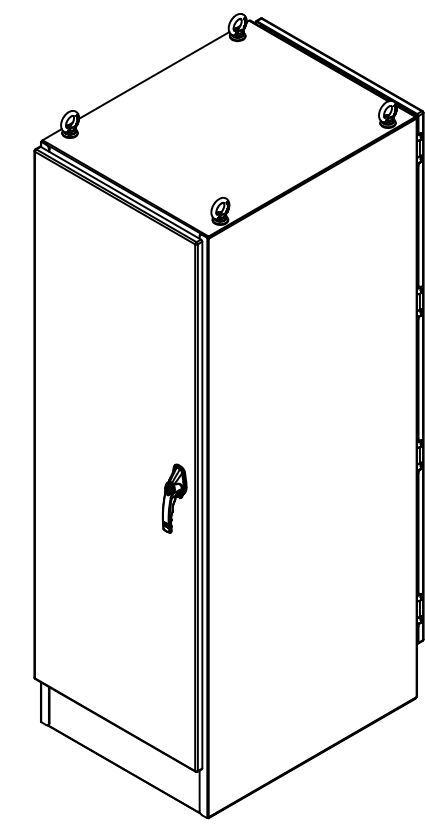

Isometric View



PACKING		
ITEM	QTY	DESCRIPTION
Cardboard sleeve	2	Top and Bottom
Cardboard strip	2	Between back of enclosure and inner panel
Plastic bag	1	To protect cover surface and inside gasket
Cardboard corner	4	To reinforced for the plastic strap tightening
Plastic strap - Black	2	To Squeeze 2 cardboard sleeve together
Packaging label	3	White label with PN
Plastic strap- Green	2	To secure the enclosure to the wood pallet
Wood Pallet	1	2" deeper and 3" larger than enclosure size

Qty	Part Number	Rev	Description
1	9500DA722430GP	0	9500DA Gland Plate
1	9500DA722430D	0	9500DA 72" x 24" Back Cover
1	9500DA722430C	0	9500DA 72" x 24" Front Cover
1	9500DA722430B	0	9500DA 72" x 24" x 30" Body
2	880EB14	2	Eye Bolt M14 (Pack of 2)
8	STK-Q-04050-10	8	M6 x 10mm Hexagon Socket Head Machine Screw with Nyseal
Parts List			

		Tél: (450) 979-4373 Fax: (450) 979-4626 www.exmweb.com		Flatness Aplatissement Max 3.0mm Projection 	
Customer Client		Date		Date 28-Oct-14	
Drawn By Dessiné Par		BoxCad: BoxCad		Date 28-Oct-14	
Material Matière		12 Ga Cold Rolled A1008 CS Type B (2.5mm)			
Color Couleur		Asa-61 Grey		Finish Fini Smooth	
Description 9500DA 72" x 24" x 30" Assembly				Detail Rev.	
Part Number Numéro Pièce				Rev. 2	
9500DA722430				0	

This drawing is confidential and must not be reproduced or used without the consent of EXM

Ce dessin est confidentiel et ne doit pas être reproduit ou utilisé sans le consentement de EXM

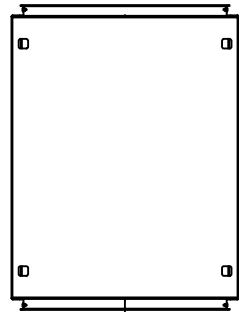

TOP

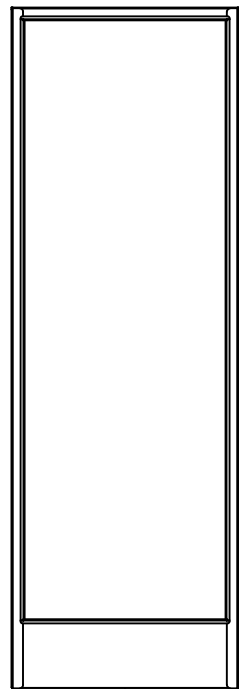

BACK

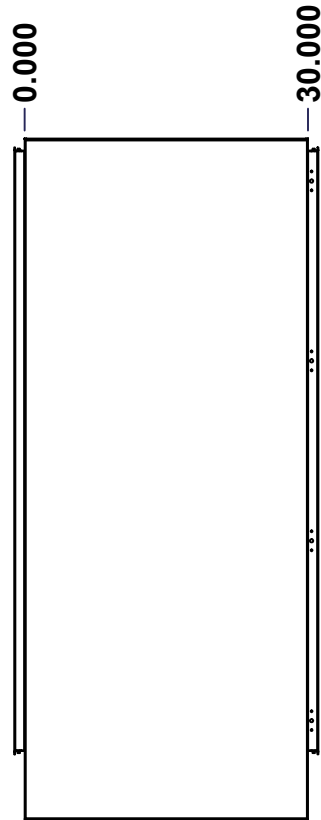

LEFT

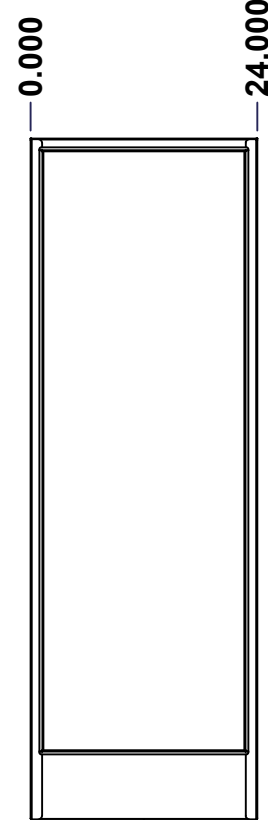

FRONT

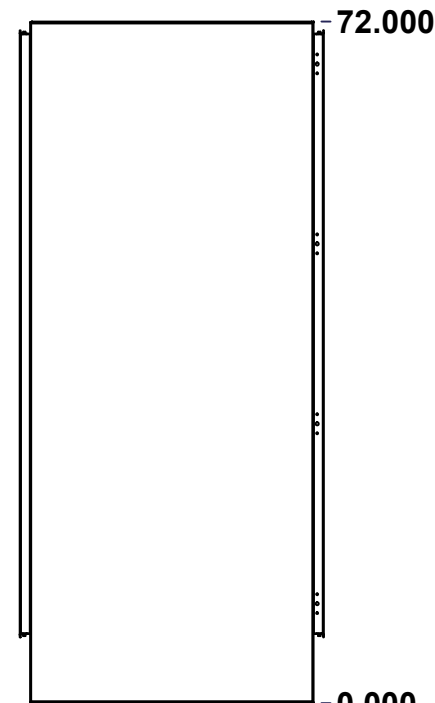

RIGHT

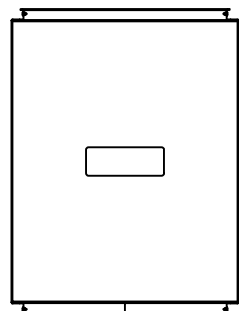

BOTTOM

No.	Revisions	Date	By/Par

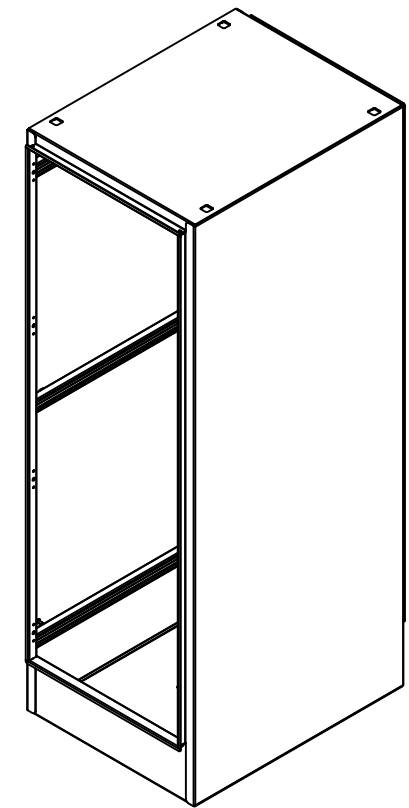

Isometric View



Tél: (450) 979-4373
 Fax: (450) 979-4626
www.exmweb.com

Flatness
Aplatissement

Max 3.0mm

Projection

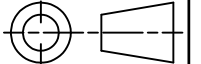

Customer Client	Date
Drawn By Dessiné Par BoxCad: BoxCad	Date 28-Oct-14
Material Matière 12 Ga Cold Rolled A1008 CS Type B (2.5mm)	
Color Couleur Asa-61 Grey	Finish Fini Smooth
Description 9500DA 72" x 24" x 30" Body	Detail Rev.
Part Number Numéro Pièce 9500DA722430B	Rev. 1 0

SEE BILL OF MATERIAL ON LAST PAGE

This drawing is confidential and must not be reproduced or used without the consent of EXM

Ce dessin est confidentiel et ne doit pas être reproduit ou utilisé sans le consentement de EXM

STANDARD FEATURES ARE NOT LISTED IN THIS HOLE TABLE

HOLE TABLE - TOP VIEW (CUSTOM FEATURE ONLY)

CUT-OUT	XDIM	YDIM	DESCRIPTION
1	11.911	26.000	Struts CR400 17.500" (Inside)
2	11.911	26.000	STUDS M6 x 10mm (Inside)
3	6.161	26.000	STUDS M6 x 10mm (Inside)
4	17.661	26.000	STUDS M6 x 10mm (Inside)

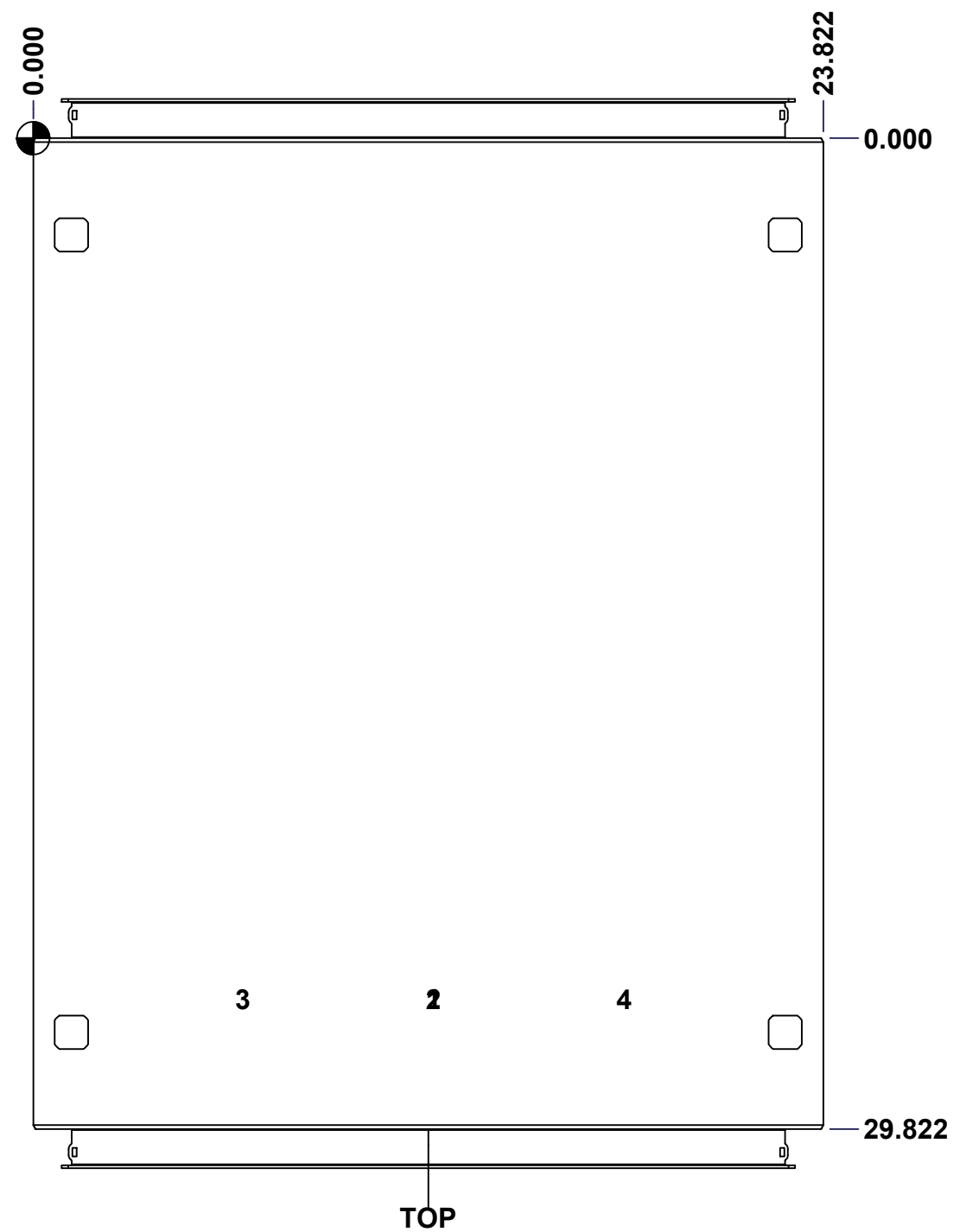

	Description		Status
	9500DA 72" x 24" x 30" Body		Released
Part Number Numéro Pièce		Rev.	
9500DA722430B		0	2 7

This drawing is confidential and must not be reproduced or used without the consent of EXM

Ce dessin est confidentiel et ne doit pas être reproduit ou utilisé sans le consentement de EXM

STANDARD FEATURES ARE NOT LISTED IN THIS HOLE TABLE

HOLE TABLE - RIGHT VIEW (CUSTOM FEATURE ONLY)

CUT-OUT	XDIM	YDIM	DESCRIPTION
1	1.500	10.286	GND STUD M6 x 16mm (Inside)
2	3.250	67.036	STUDS M6 x 10mm (Inside)
3	26.750	67.036	STUDS M6 x 10mm (Inside)
4	15.000	67.036	STUDS M6 x 10mm (Inside)
5	3.250	8.786	STUDS M6 x 10mm (Inside)
6	26.750	8.786	STUDS M6 x 10mm (Inside)
7	15.000	8.786	STUDS M6 x 10mm (Inside)
8	3.250	37.911	STUDS M6 x 10mm (Inside)
9	26.750	37.911	STUDS M6 x 10mm (Inside)
10	15.000	37.911	STUDS M6 x 10mm (Inside)

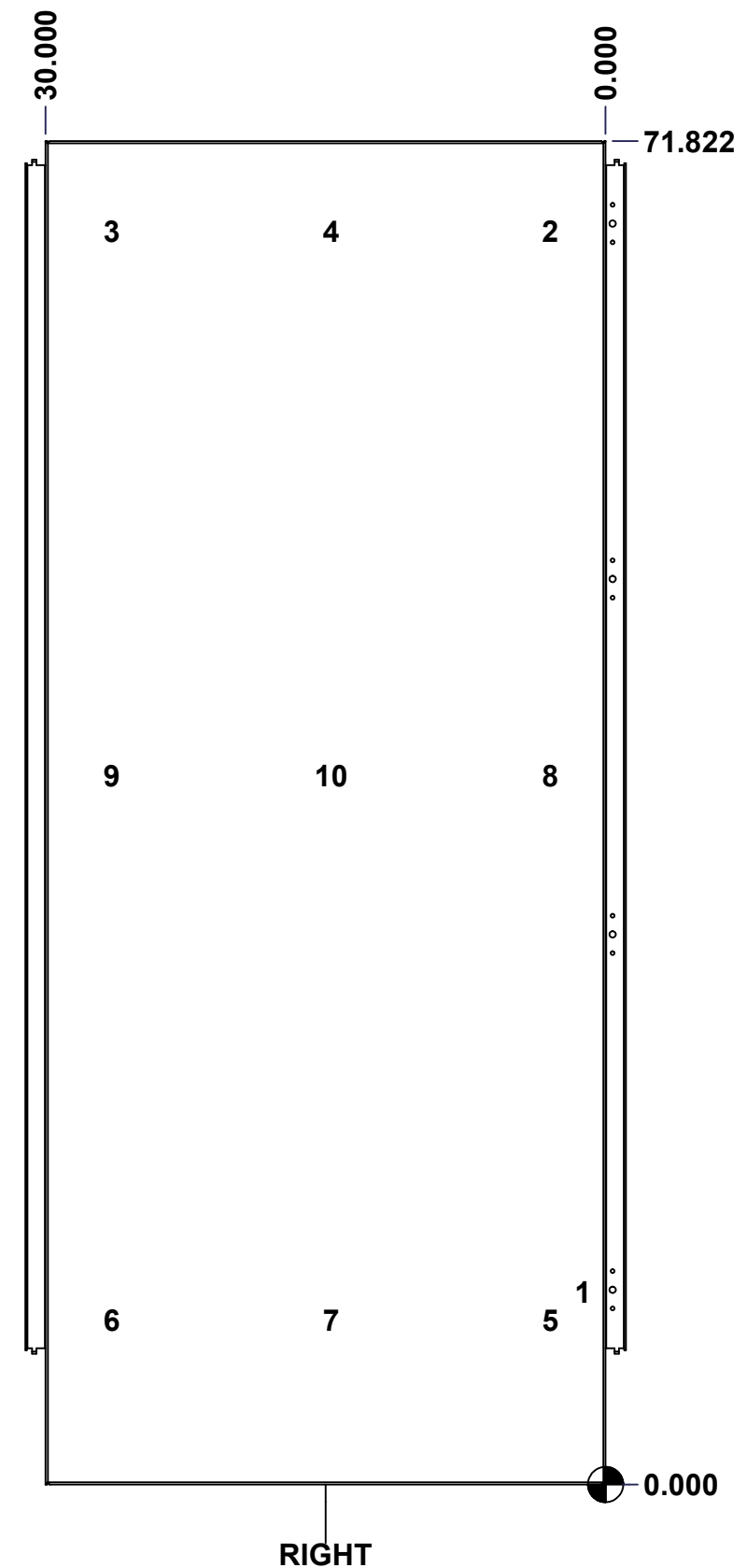

RIGHT

	Description	Status
	9500DA 72" x 24" x 30" Body	Released
	Part Number Numéro Pièce	Rev.
	9500DA722430B	0
		3
		7

This drawing is confidential and must not be reproduced or used without the consent of EXM

Ce dessin est confidentiel et ne doit pas être reproduit ou utilisé sans le consentement de EXM

STANDARD FEATURES ARE NOT LISTED IN THIS HOLE TABLE

HOLE TABLE - BOTTOM VIEW (CUSTOM FEATURE ONLY)

CUT-OUT	XDIM	YDIM	DESCRIPTION
1	7.286	15.000	GP STUD M6 x 16mm (Inside)
2	16.536	15.000	GP STUD M6 x 16mm (Inside)

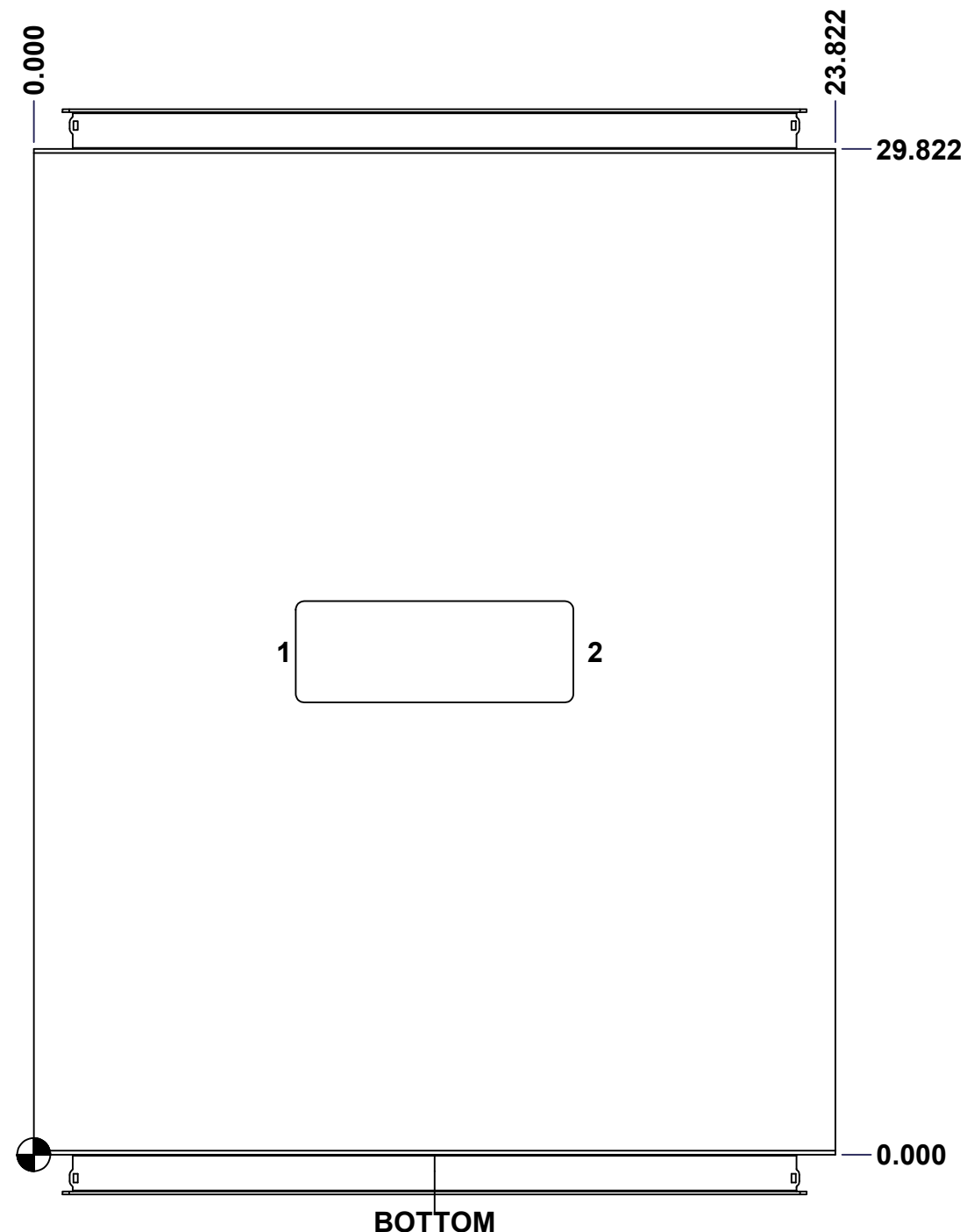

BOTTOM

	Description	Status
	9500DA 72" x 24" x 30" Body	Released
	Part Number Numéro Pièce	Rev.
	9500DA722430BB	0
		4 / 7

This drawing is confidential and must not be reproduced or used without the consent of EXM

Ce dessin est confidentiel et ne doit pas être reproduit ou utilisé sans le consentement de EXM

STANDARD FEATURES ARE NOT LISTED IN THIS HOLE TABLE

HOLE TABLE - LEFT VIEW (CUSTOM FEATURE ONLY)

CUT-OUT	XDIM	YDIM	DESCRIPTION
1	28.411	10.286	GND STUD M6 x 16mm (Inside)
2	3.161	67.036	STUDS M6 x 10mm (Inside)
3	26.661	67.036	STUDS M6 x 10mm (Inside)
4	14.911	67.036	STUDS M6 x 10mm (Inside)
5	3.161	8.786	STUDS M6 x 10mm (Inside)
6	26.661	8.786	STUDS M6 x 10mm (Inside)
7	14.911	8.786	STUDS M6 x 10mm (Inside)
8	3.161	37.911	STUDS M6 x 10mm (Inside)
9	26.661	37.911	STUDS M6 x 10mm (Inside)
10	14.911	37.911	STUDS M6 x 10mm (Inside)

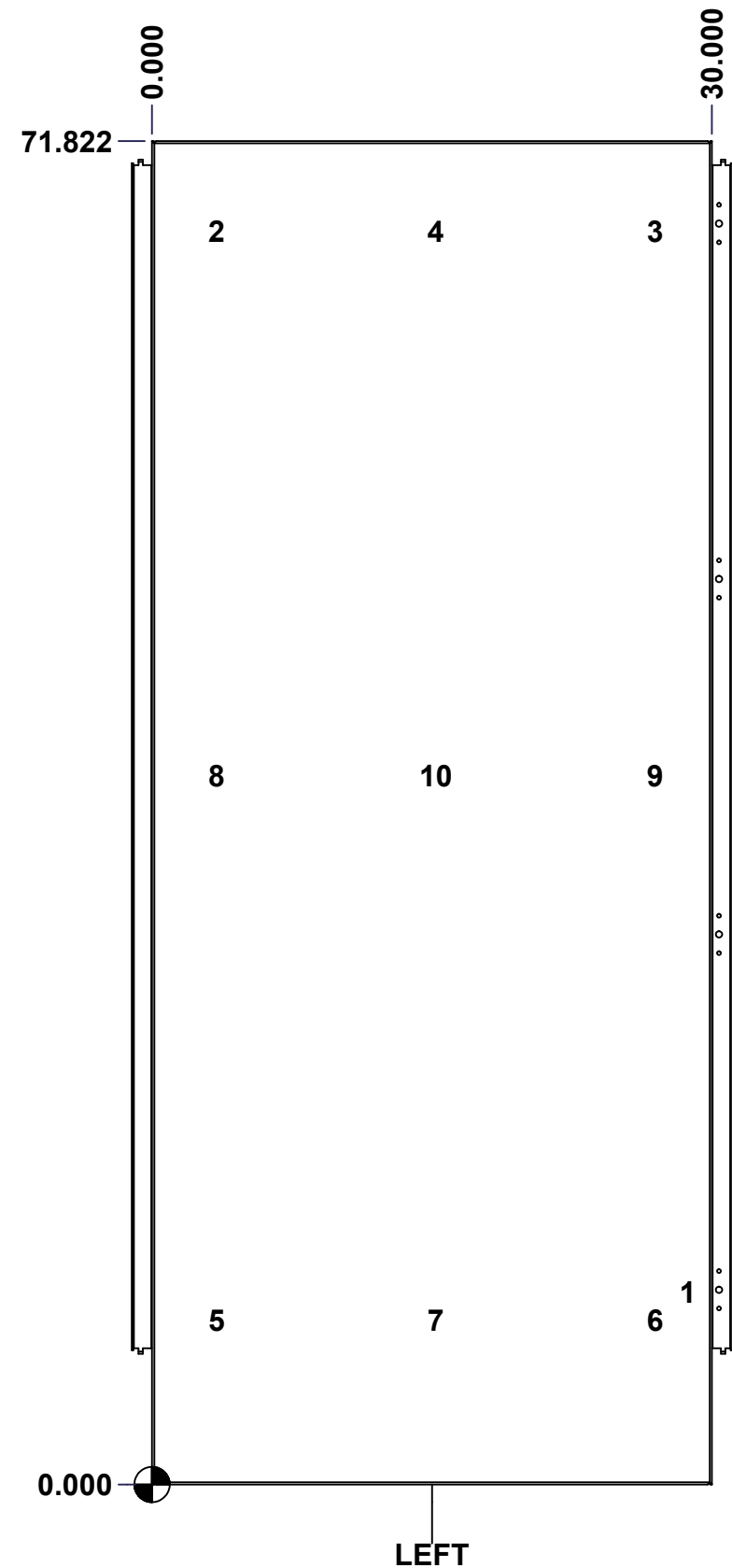

	Description	Status	
	9500DA 72" x 24" x 30" Body	Released	
	Part Number Numéro Pièce	Rev.	5
	9500DA722430B	0	7

This drawing is confidential and must not be reproduced or used without the consent of EXM

Ce dessin est confidentiel et ne doit pas être reproduit ou utilisé sans le consentement de EXM

No.	Revisions	Date	By/Par

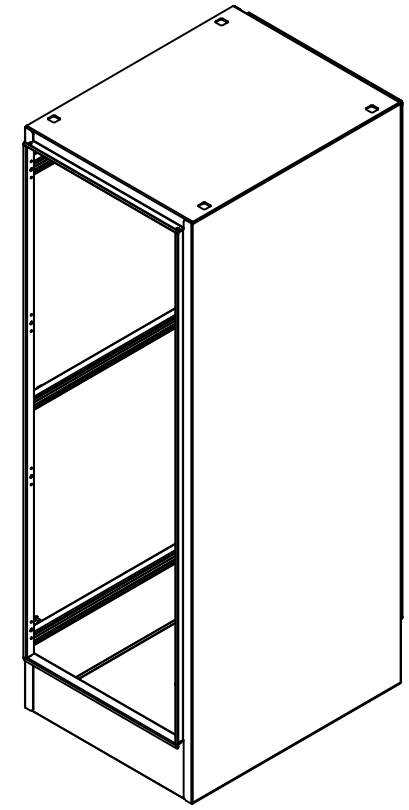

Isometric View

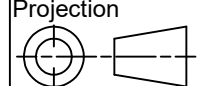

Qty	Part Number	Rev	Description
21	STK-Q-16030	0	Stud M6 x 10mm
1	CR400MS_17.5	0	Commercial Roll Mild Steel (17.5in long)
1	STK-P-02400S	0	Powder Paint (Asa-61 Grey / Smooth)
2	STK-Q-52200-30	2	Sasco Strut S5 (27.500" Long)
4	STK-Q-52250-30	0	Sasco Strut S5 (29.500" Long)
1	9500DA722430RS-P	0	9500DA 72" x 24" Right Part
1	9500DA722430BT-P	0	9500DA 24" x 30" Bottom Part
1	9500DA722430LS-P	0	9500DA 72" x 24" Left Part
1	9500DA722430T-P	0	9500DA 24" x 30" Top Part
21	STK-Q-07220	1	M6 Nylon Insert Lock Nut
4	STK-Q-16080	0	Ground Stud M6 x 16mm

 Tél: (450) 979-4373 Fax: (450) 979-4626 www.exmweb.com		Flatness Aplatissement Max 3.0mm Projection 
Customer Client	Date	Date 28-Oct-14
Drawn By Dessiné Par	BoxCad: BoxCad	
Material Matière	12 Ga Cold Rolled A1008 CS Type B (2.5mm)	
Color Couleur	Asa-61 Grey	Finish Fini Smooth
Description	9500DA 72" x 24" x 30" Body	
Part Number Numéro Pièce	Rev. 0	2
9500DA722430B		2

Parts List

This drawing is confidential and must not be reproduced or used without the consent of EXM

Ce dessin est confidentiel et ne doit pas être reproduit ou utilisé sans le consentement de EXM



TOP

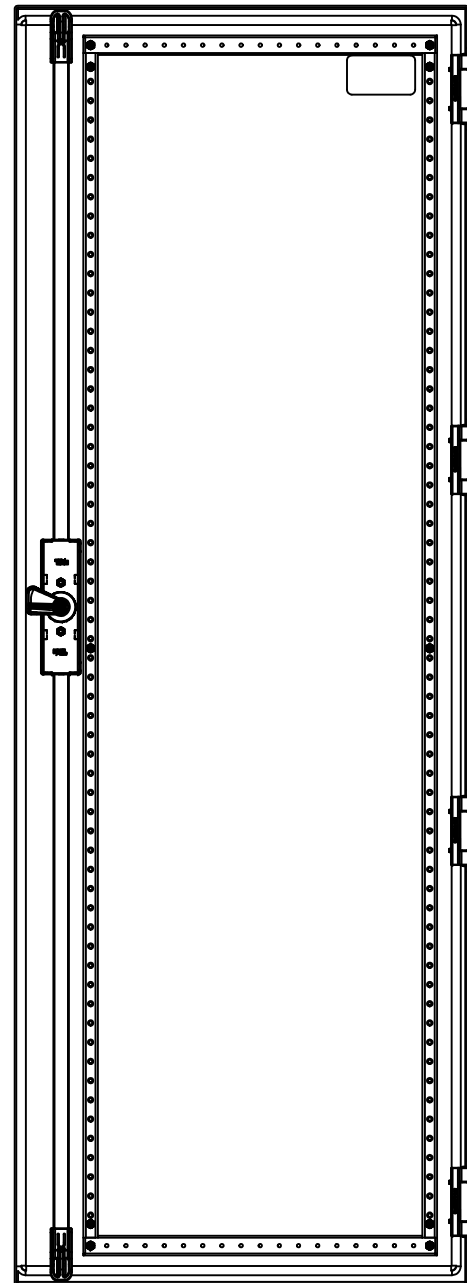

BACK



BOTTOM

0.000
0.835

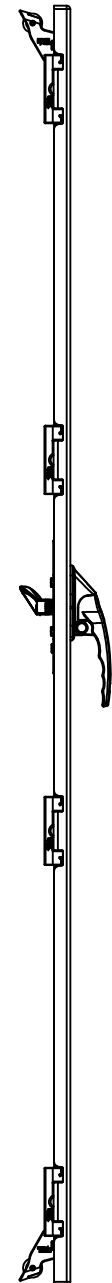

LEFT

0.000
23.312

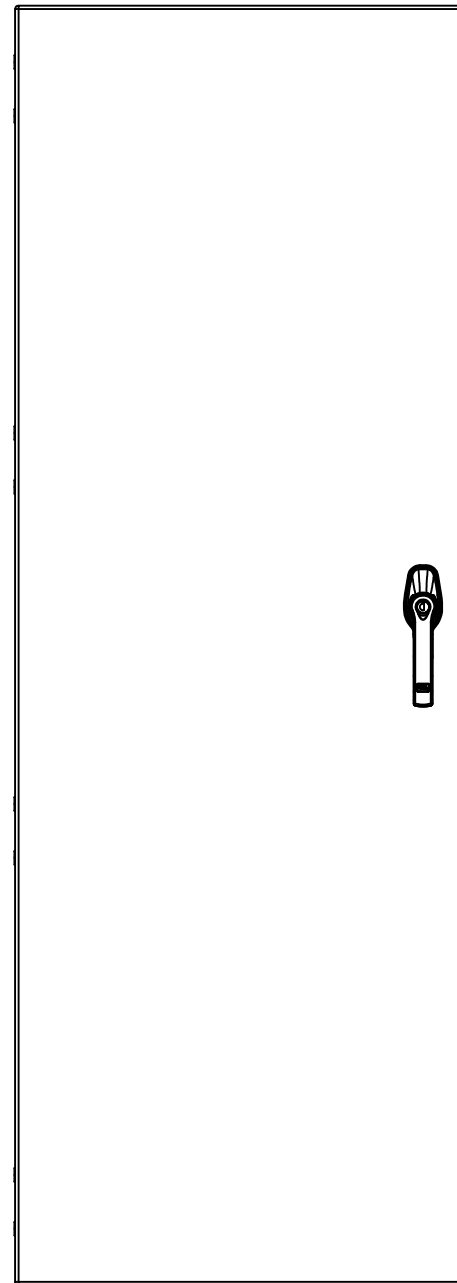

FRONT

65.549

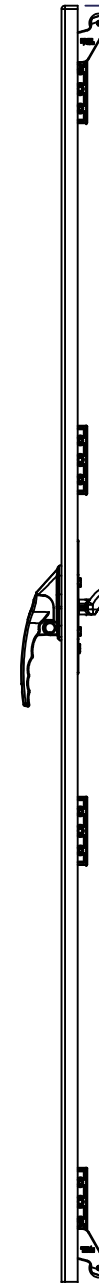

RIGHT

0.000

No.	Revisions	Date	By/Par

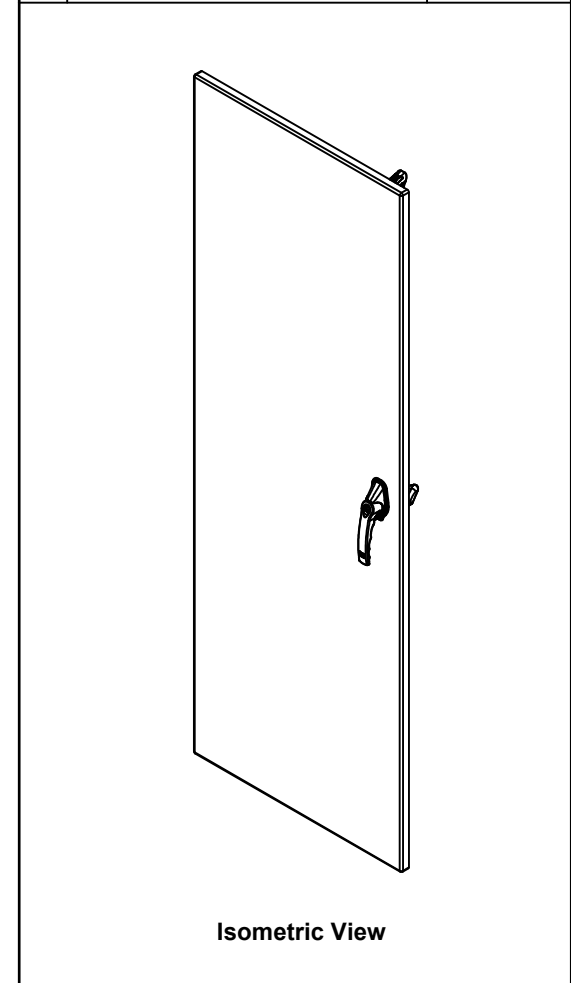

Isometric View

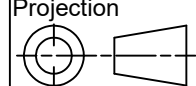

 Tél: (450) 979-4373 Fax: (450) 979-4626 www.exmweb.com		Flatness Aplatissement Max 3.0mm Projection 
Customer Client		Date
Drawn By Dessiné Par	BoxCad: BoxCad	Date 28-Oct-14
Material Matière	12 Ga Cold Rolled A1008 CS Type B (2.5mm)	
Color Couleur	Asa-61 Grey	Finish Fini Smooth
Description	9500DA 72" x 24" Front Cover	
Part Number Numéro Pièce	9500DA722430C	Detail Rev. Rev. 1 0 / 3

SEE BILL OF MATERIAL ON LAST PAGE

This drawing is confidential and must not be reproduced or used without the consent of EXM

Ce dessin est confidentiel et ne doit pas être reproduit ou utilisé sans le consentement de EXM

STANDARD FEATURES ARE NOT LISTED IN THIS HOLE TABLE

HOLE TABLE - FRONT VIEW (CUSTOM FEATURE ONLY)

CUT-OUT	XDIM	YDIM	DESCRIPTION
1	2.000	2.028	STUD M6 x 18mm (Inside)
2	2.000	32.628	STUD M6 x 18mm (Inside)
3	2.000	63.521	STUD M6 x 18mm (Inside)
4	19.407	2.028	STUD M6 x 18mm (Inside)
5	19.407	32.628	STUD M6 x 18mm (Inside)
6	19.407	63.521	STUD M6 x 18mm (Inside)
7	2.000	3.139	STUD M6 x 18mm (Inside)
8	2.000	62.409	STUD M6 x 18mm (Inside)
9	19.407	3.139	STUD M6 x 18mm (Inside)
10	19.407	62.409	STUD M6 x 18mm (Inside)
11	20.937	6.118	STUD M6 x 18mm (Inside)
12	20.937	59.430	STUD M6 x 18mm (Inside)
-----	-----	-----	-----
13	20.937	34.743	HANDLE 885 ESL2A-APHK @ 0.0°

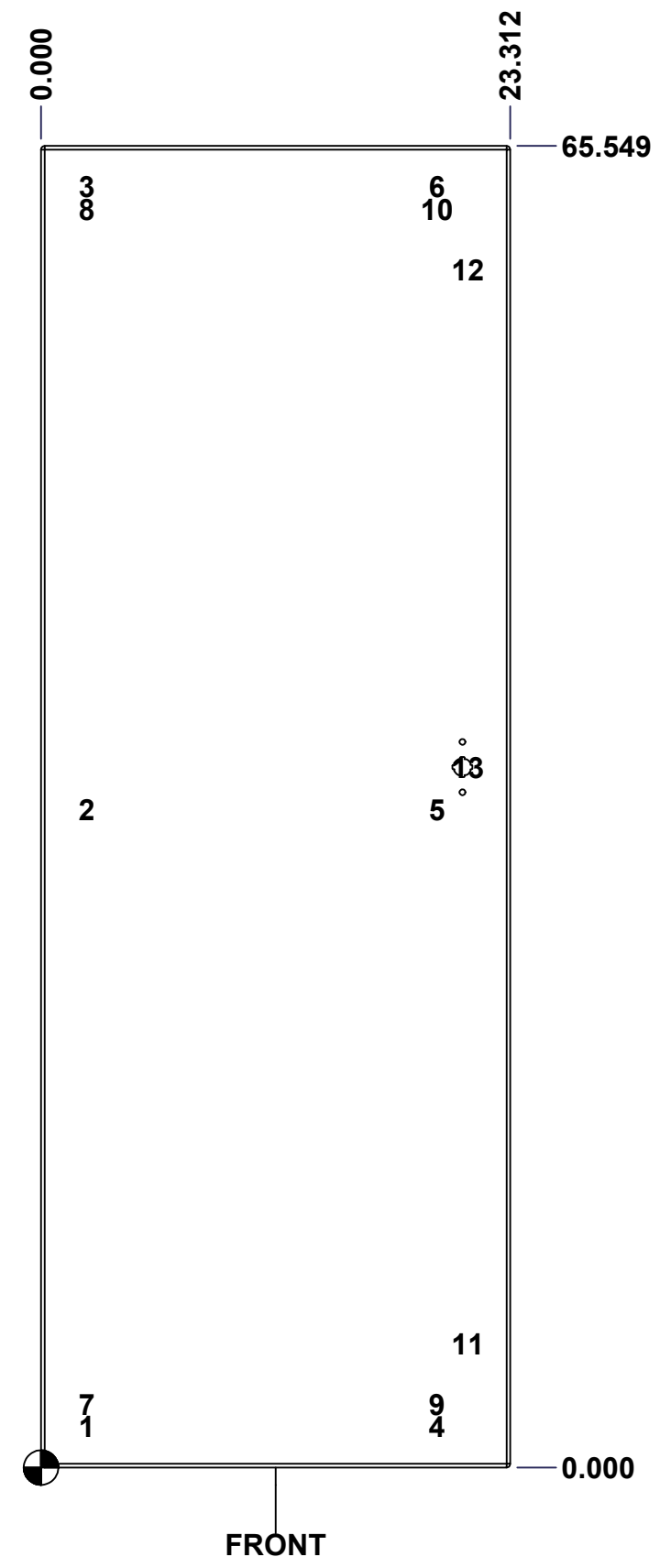

FRONT

	Description	Status	
	9500DA 72" x 24" Front Cover	(NULL)	
	Part Number Numéro Pièce	Rev.	
	9500DA722430C	0	2 3

This drawing is confidential and must not be reproduced or used without the consent of EXM

Ce dessin est confidentiel et ne doit pas être reproduit ou utilisé sans le consentement de EXM

No.	Revisions	Date	By/Par

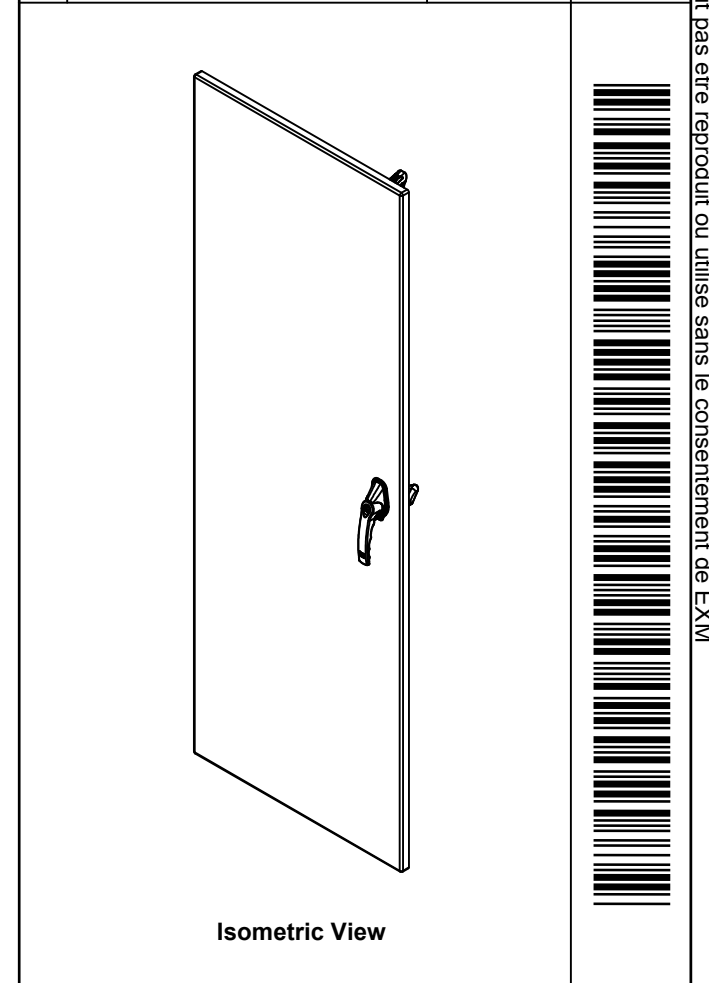

Qty	Part Name	Rev	Description
1	STK-Q-47527	1	9500 Lower Closing Bar 72"
1	STK-Q-47517	1	9500 Upper Closing Bar 72"
1	STK-A-03886-36	2	Gearbox Clockwise Assembly (36.0mm)
1	885ESL2A-APHK	6	885 ESL2A-APHK - Zinc Die Cast L-Handle Padlockable Assy
1	STK-P-02400S	0	Powder Paint (Asa-61 Grey / Smooth)
1	STK-S-00100	0	3.5" x 2" Silver Milar Flexcon Sticker
1	9500DA722430G	0	9500DA 72" x 24" Cover Gasket
1	STK-K-10830	3	9500 - Door Stiffener Assembly
2	STK-Q-16410	0	Guide Stud - Largel (No Paint Cap Required)
10	STK-Q-16055	1	M6 x 18mm Stud (No Paint Cap Required)
1	9500DA722430C-P	0	9500DA 72" x 24" Front Cover Part
4	STK-K-09860	7	Cabinet Hinge with Captive Pins
2	STK-A-90025	0	9500 - Cabinet Closing Bar End (Large)
Qty	Part Name	Rev	Description
Parts List			

 Tél: (450) 979-4373 Fax: (450) 979-4626 www.exmweb.com		Flatness Aplatissement	
		Max 3.0mm	
Customer Client		Date	
Drawn By Dessiné Par		Date 28-Oct-14	
Material Matière		12 Ga Cold Rolled A1008 CS Type B (2.5mm)	
Color Couleur		Asa-61 Grey	Finish Fini Smooth
Description			Detail Rev.
9500DA 72" x 24" Front Cover			
Part Number Numéro Pièce		Rev.	3
9500DA722430C		0	3

This drawing is confidential and must not be reproduced or used without the consent of EXM

Ce dessin est confidentiel et ne doit pas être reproduit ou utilisé sans le consentement de EXM



TOP

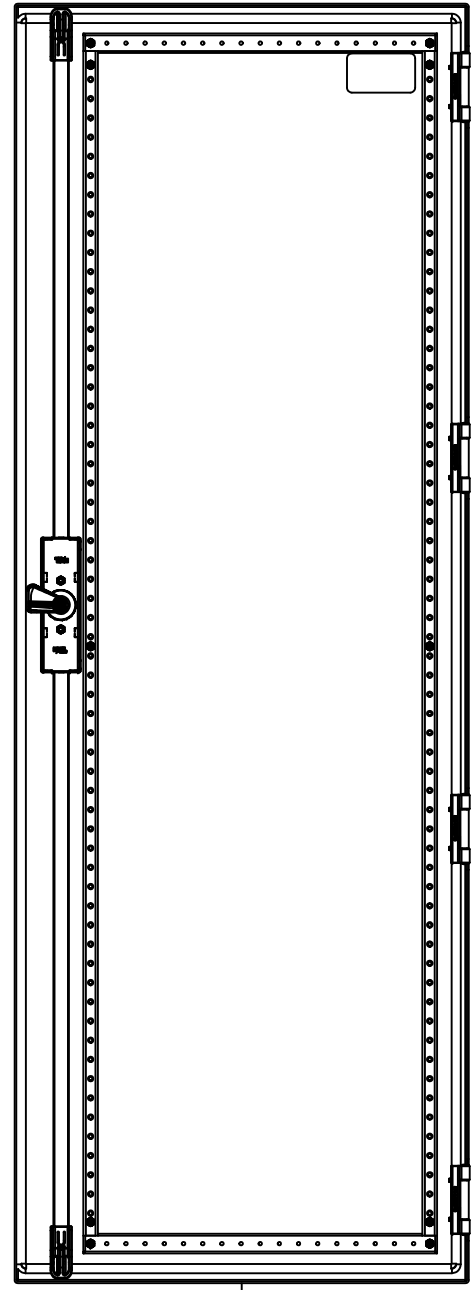

BACK



BOTTOM

0.000
0.835

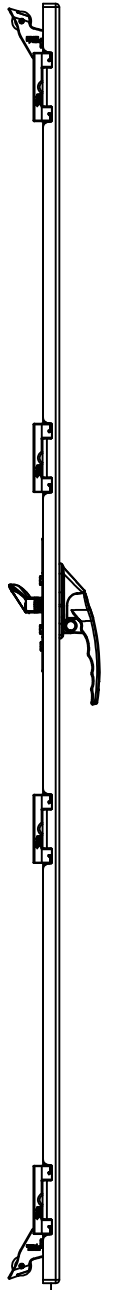

LEFT

0.000

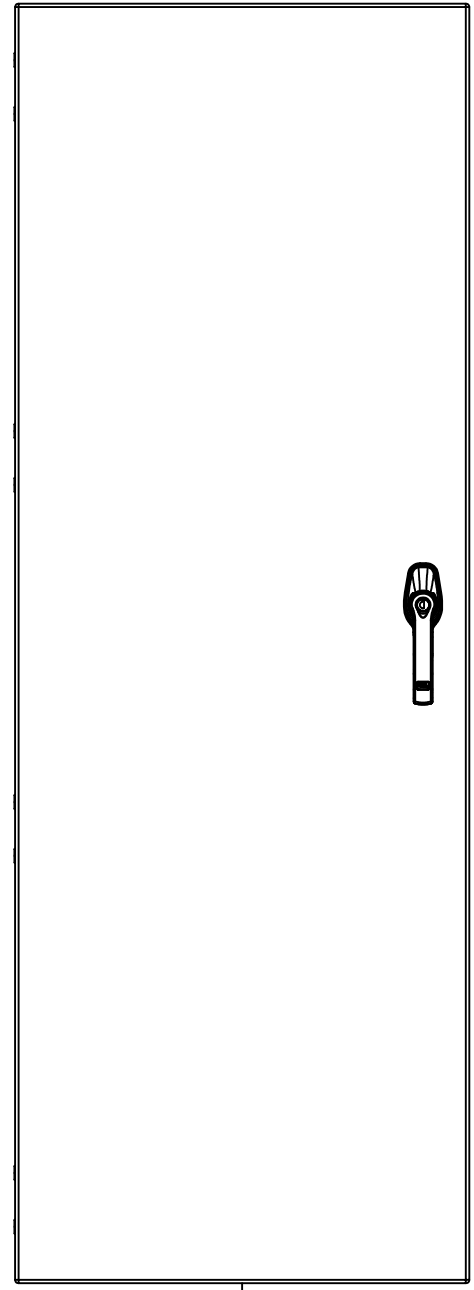

FRONT

23.312

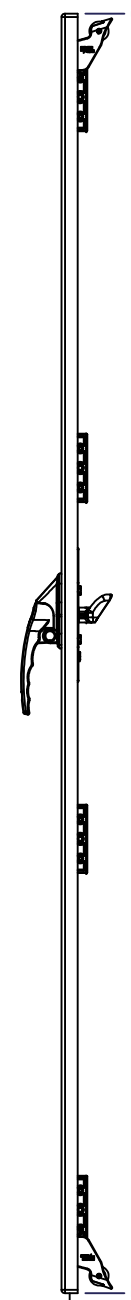

RIGHT

65.549

0.000

No.	Revisions	Date	By/Par

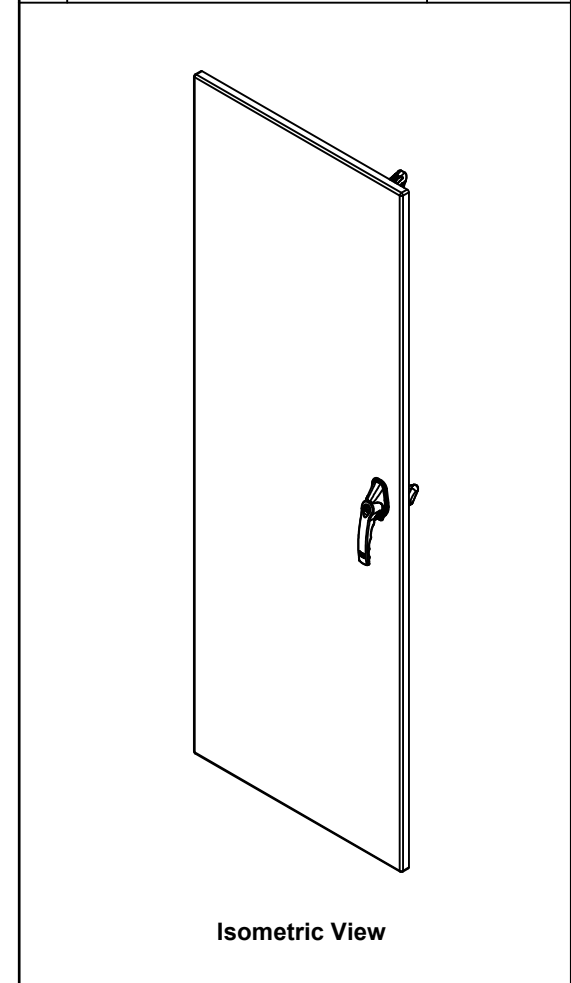

Isometric View

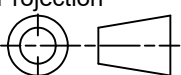

 Tél: (450) 979-4373 Fax: (450) 979-4626 www.exmweb.com		Flatness Aplatissement Max 3.0mm Projection 
Customer Client	BoxCad: BoxCad	Date 28-Oct-14
Material Matière 12 Ga Cold Rolled A1008 CS Type B (2.5mm)		
Color Couleur Asa-61 Grey	Finish Fini Smooth	
Description 9500DA 72" x 24" Back Cover		Detail Rev.
Part Number Numéro Pièce 9500DA722430D	Rev. 0	1 / 3

SEE BILL OF MATERIAL ON LAST PAGE

This drawing is confidential and must not be reproduced or used without the consent of EXM

Ce dessin est confidentiel et ne doit pas être reproduit ou utilisé sans le consentement de EXM

STANDARD FEATURES ARE NOT LISTED IN THIS HOLE TABLE

HOLE TABLE - FRONT VIEW (CUSTOM FEATURE ONLY)

CUT-OUT	XDIM	YDIM	DESCRIPTION
1	2.000	2.028	STUD M6 x 18mm (Inside)
2	2.000	32.628	STUD M6 x 18mm (Inside)
3	2.000	63.521	STUD M6 x 18mm (Inside)
4	19.407	2.028	STUD M6 x 18mm (Inside)
5	19.407	32.628	STUD M6 x 18mm (Inside)
6	19.407	63.521	STUD M6 x 18mm (Inside)
7	2.000	3.139	STUD M6 x 18mm (Inside)
8	2.000	62.409	STUD M6 x 18mm (Inside)
9	19.407	3.139	STUD M6 x 18mm (Inside)
10	19.407	62.409	STUD M6 x 18mm (Inside)
11	20.937	6.118	STUD M6 x 18mm (Inside)
12	20.937	59.430	STUD M6 x 18mm (Inside)
-----	-----	-----	-----
13	20.937	34.743	HANDLE 885 ESL2A-APHK @ 0.0°

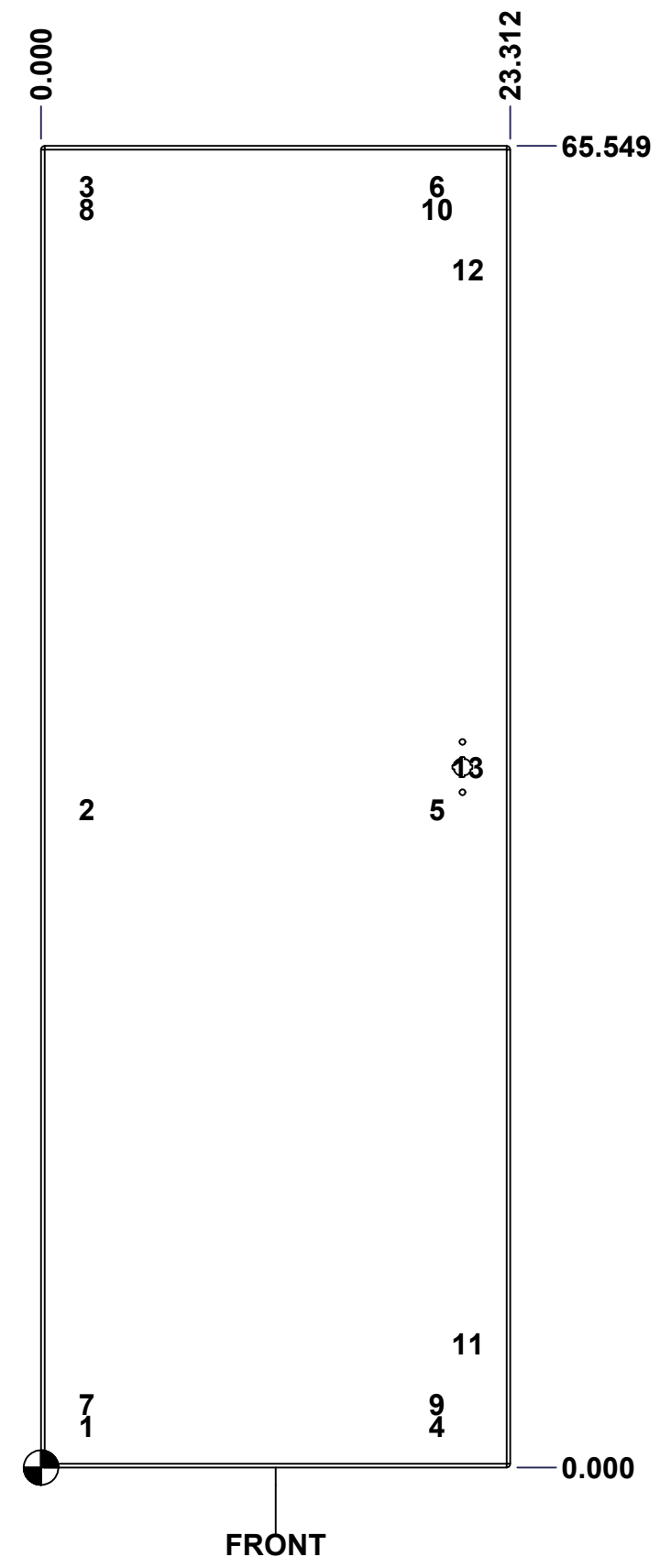

FRONT

	Description	Status	
	9500DA 72" x 24" Back Cover	(NULL)	
	Part Number Numéro Pièce	Rev.	
	9500DA722430D	0	2 3

This drawing is confidential and must not be reproduced or used without the consent of EXM

Ce dessin est confidentiel et ne doit pas être reproduit ou utilisé sans le consentement de EXM

No.	Revisions	Date	By/Par

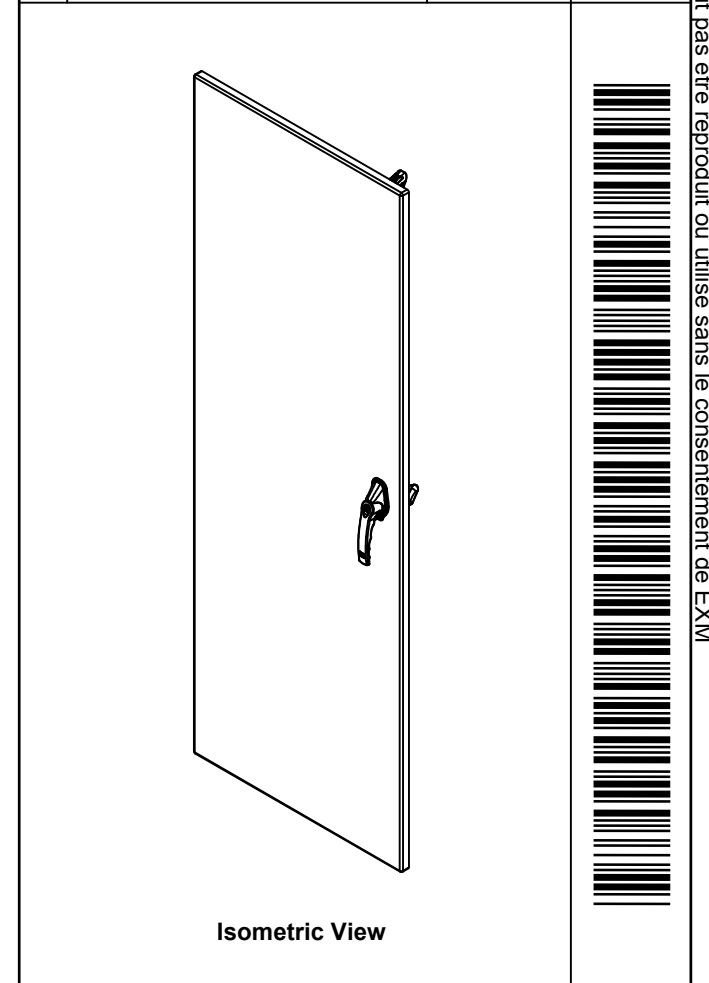

1	STK-Q-47527	1	9500 Lower Closing Bar 72"
1	STK-Q-47517	1	9500 Upper Closing Bar 72"
1	STK-A-03886-36	2	Gearbox Clockwise Assembly (36.0mm)
1	885ESL2A-APHK	6	885 ESL2A-APHK - Zinc Die Cast L-Handle Padlockable Assy
1	STK-P-02400S	0	Powder Paint (Asa-61 Grey / Smooth)
1	STK-S-00100	0	3.5" x 2" Silver Milar Flexcon Sticker
1	9500DA722430G	0	9500DA 72" x 24" Cover Gasket
1	STK-K-10830	3	9500 - Door Stiffener Assembly
2	STK-Q-16410	0	Guide Stud - Largel (No Paint Cap Required)
10	STK-Q-16055	1	M6 x 18mm Stud (No Paint Cap Required)
1	9500DA722430D-P	0	9500DA 72" x 24" Back Cover Part
4	STK-K-09860	7	Cabinet Hinge with Captive Pins
2	STK-A-90025	0	9500 - Cabinet Closing Bar End (Large)
Qty	Part Name	Rev	Description
Parts List			

 Tél: (450) 979-4373 Fax: (450) 979-4626 www.exmweb.com		Flatness Aplatissement	
		Max 3.0mm	
Customer Client		Date	
Drawn By Dessiné Par BoxCad: BoxCad		Date 28-Oct-14	
Material Matière 12 Ga Cold Rolled A1008 CS Type B (2.5mm)		Projection	
Color Couleur Asa-61 Grey		Finish Fini Smooth	
Description 9500DA 72" x 24" Back Cover		Detail Rev.	
Part Number Numéro Pièce 9500DA722430D		Rev. 0	3

All knockouts are actual size / Les disques défonçables sont grandeur réel
 All dimensions are before paint / Toutes les dimensions sont avant peinture

This drawing is confidential and must not be reproduced or used without the consent of EXM

Ce dessin est confidentiel et ne doit pas être reproduit ou utilisé sans le consentement de EXM

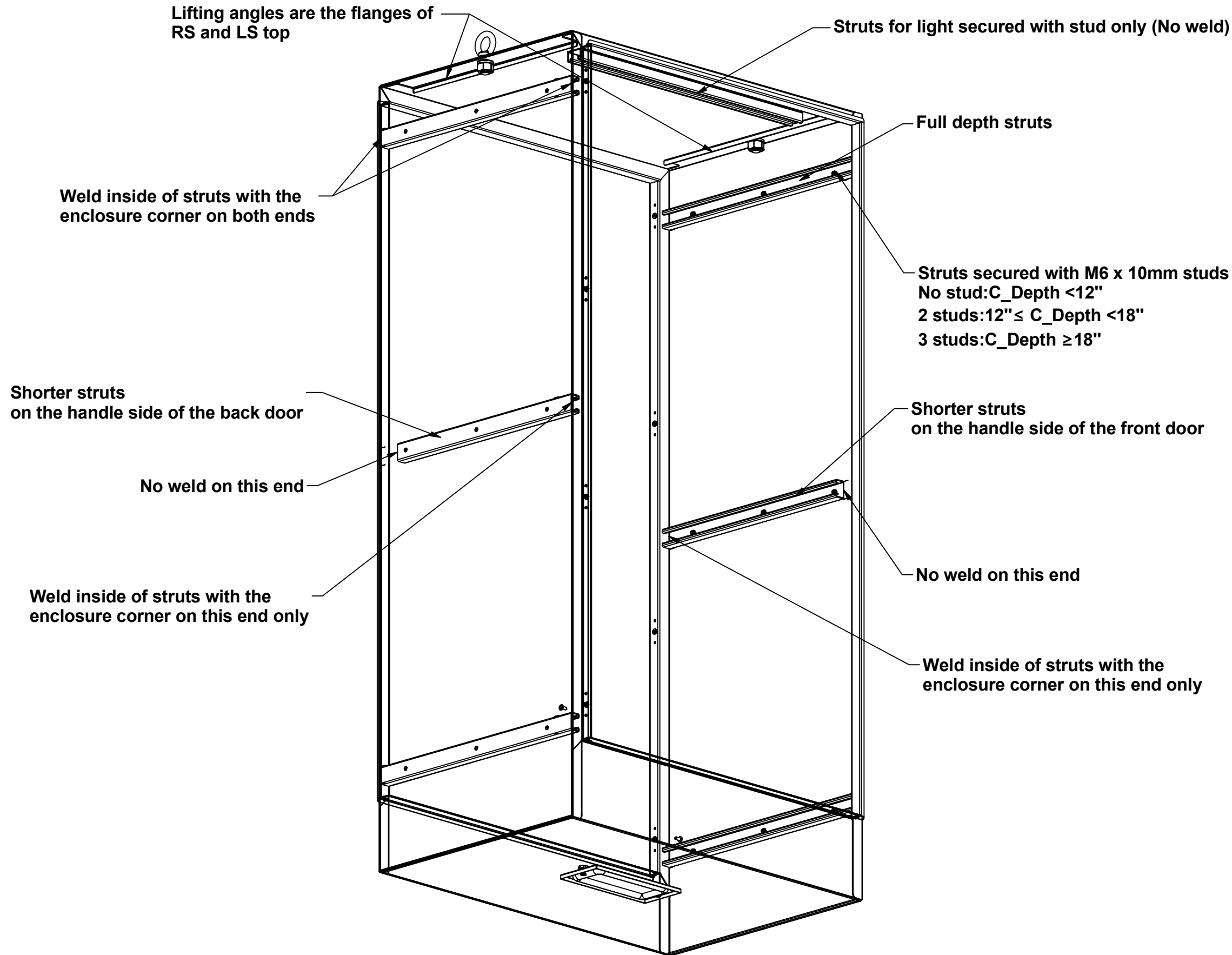

No.	Revisions	Date	By/Par

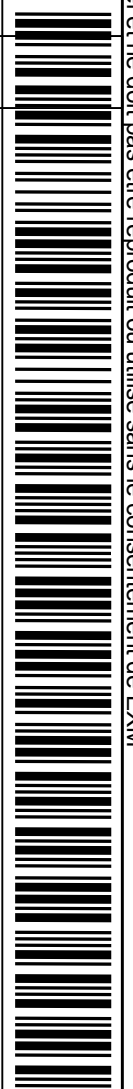
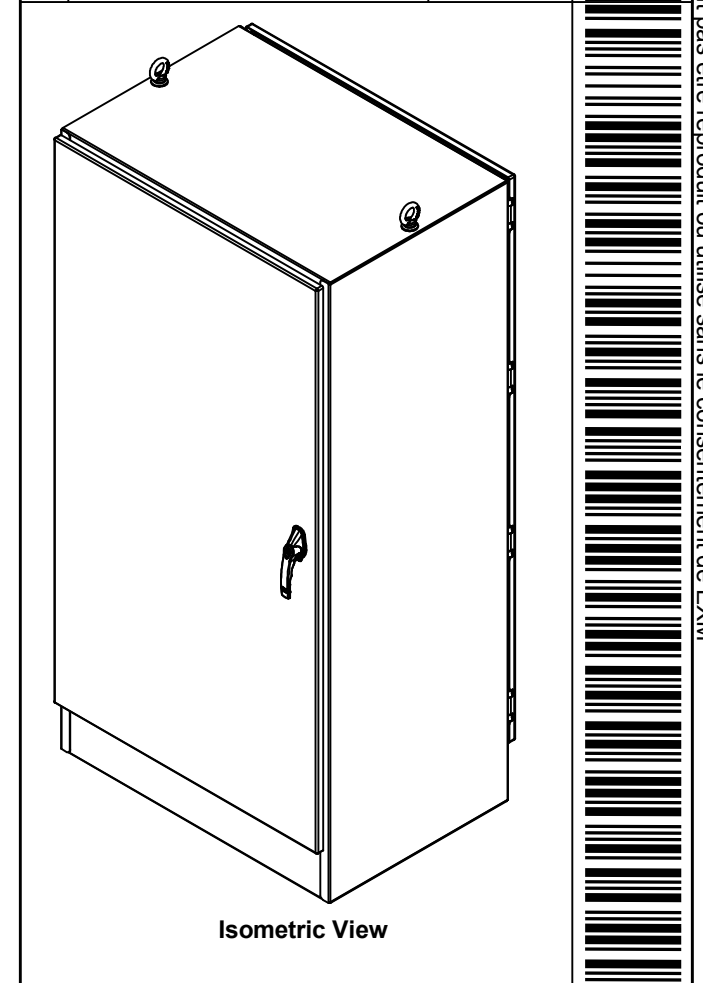

Tél: (450) 979-4373 Fax: (450) 979-4626 www.exmweb.com		Flatness Aplatissement Max 3.0mm Projection
Customer Client	Date	
Drawn By / Dessiné Par: PatrickD	Date: 3/9/2020	
Material / Matière	N/A	
Color / Couleur: N/A	Finish / Fini: N/A	
Description: 9500DA Welding Detail	Detail Rev.	
Part Number / Numéro Pièce: 9500DA_WELDING_DETAIL	Rev. 0	1 / 1