

This drawing is confidential and must not be reproduced or used without the consent of EXM

Ce dessin est confidentiel et ne doit pas être reproduit ou utilisé sans le consentement de EXM

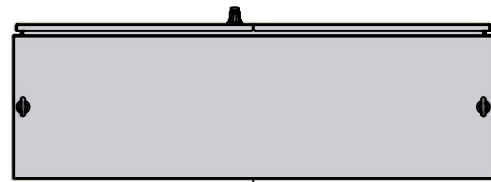

TOP

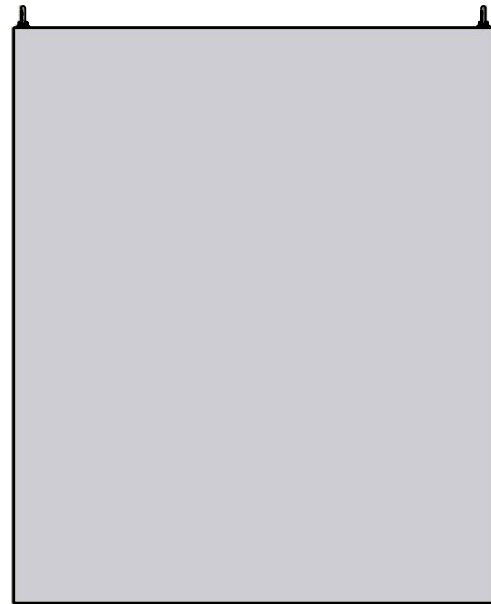

BACK

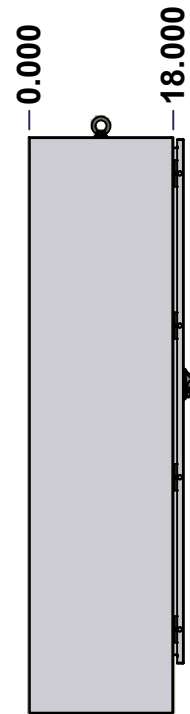

LEFT

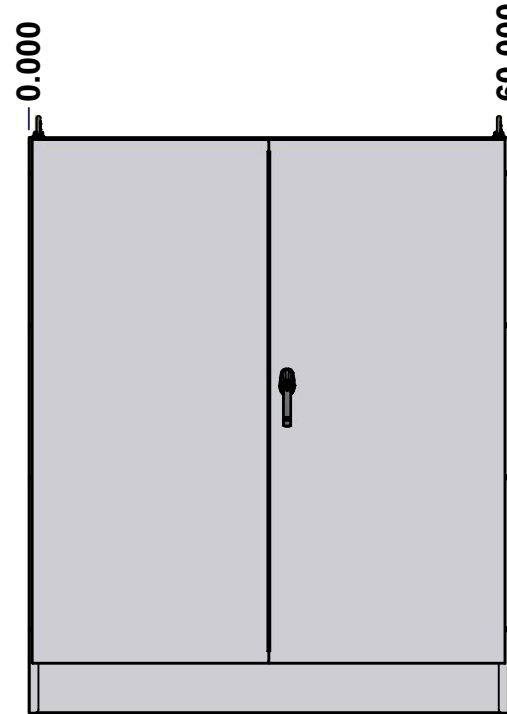

FRONT

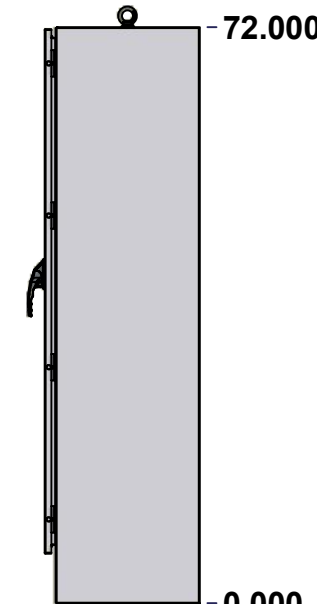

RIGHT

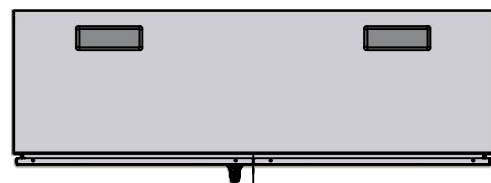

BOTTOM

No.	Revisions	Date	By/Par
0.1	Update to latest design in BOXCAD	2022/10/8	Hunter
0.2	update hinge to STK-A-33012	2022/11/29	Zin

Isometric View

Tél: (450) 979-4373 Fax: (450) 979-4626 www.exmweb.com		Flatness Aplatissement	
		Max 3.0mm	
Customer Client		Date	
Drawn By Dessiné Par BoxCad: BoxCad		Date 12/7/2021	
Material Matière 12 Ga Cold Rolled A1008 CS Type B (2.5mm)			
Color Couleur Asa-61 Grey		Finish Fini Smooth	
Description 9500DD 72" x 60" x 18" Assembly			Detail Rev.
Part Number Numéro Pièce 9500STDD726018		Rev. 0	1 / 15

SEE BILL OF MATERIAL ON LAST PAGE

This drawing is confidential and must not be reproduced or used without the consent of EXM

Ce dessin est confidentiel et ne doit pas être reproduit ou utilisé sans le consentement de EXM

NOTE	
ITEM	DESCRIPTION
1	NEMA 12/13 Enclosure
2	C/W Standard ground studs on box and cover
3	C/W Standard door stiffener
4	W/O Inner panel
5	C/W Standard inner panel mounting studs
6	C/W Struts installed (Included)
7	C/W Eyebolts

No.	Revisions	Date	By/Par
0.1	Update to latest design in BOXCAD	2022/10/8	Hunter
0.2	update hinge to STK-A-33012	2022/11/29	Zin

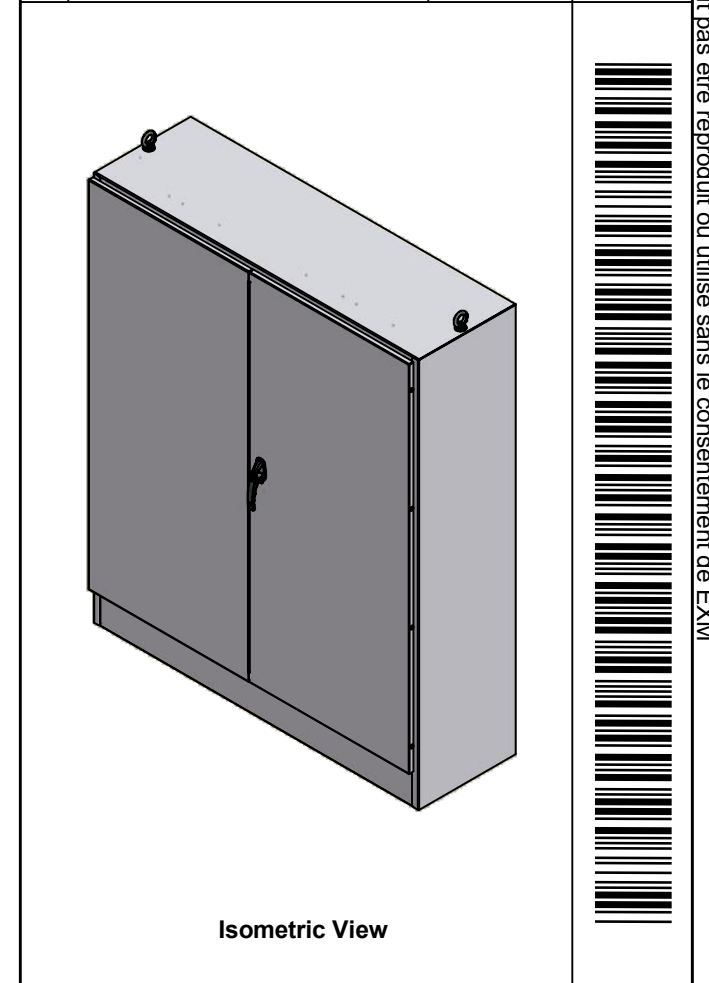



Tél: (450) 979-4373
Fax: (450) 979-4626
www.exmweb.com

Flatness
Aplatissement
Max 3.0mm

Projection



PACKING		
ITEM	QTY	DESCRIPTION
Cardboard sleeve	2	Top and Bottom
Cardboard strip	2	Between back of enclosure and inner panel
Plastic bag	1	To protect cover surface and inside gasket
Cardboard corner	4	To reinforced for the plastic strap tightening
Plastic strap - Black	2	To Squeeze 2 cardboard sleeve together
Packaging label	3	White label with PN
Plastic strap- Green	2	To secure the enclosure to the wood pallet
Wood Pallet	1	2" deeper and 3" larger than enclosure size

1	880EB14	2	Eye Bolt M14 (Pack of 2)
1	9500STDD726018FD	0	9500DD 72" x 60" Flange Door
1	9500STDD726018LD	0	9500DD 72" x 60" Lock Door
1	9500STDD726018B	0	9500DD 72" x 60" x 18" Body
2	9500STDD726018GP	0	9500DD Gland Plate
8	STK-Q-04050-10	8	M6 x 10mm Hexagon Socket Head Machine Screw with Nyseal
Qty	Part Number	Rev	Description
Parts List			

Customer Client	Date
Drawn By Dessiné Par	BoxCad: BoxCad
Date	12/7/2021
Material Matière	12 Ga Cold Rolled A1008 CS Type B (2.5mm)
Color Couleur	Asa-61 Grey
Finish Fini	Smooth
Description	9500DD 72" x 60" x 18" Assembly
Part Number Numéro Pièce	9500STDD726018
Rev.	2
	0
	15

This drawing is confidential and must not be reproduced or used without the consent of EXM

Ce dessin est confidentiel et ne doit pas être reproduit ou utilisé sans le consentement de EXM



TOP

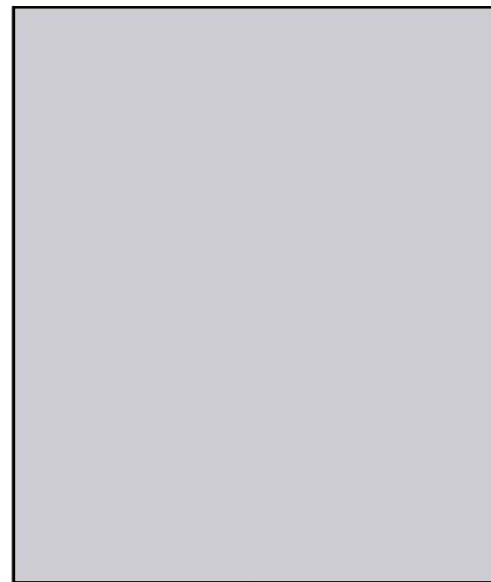

BACK

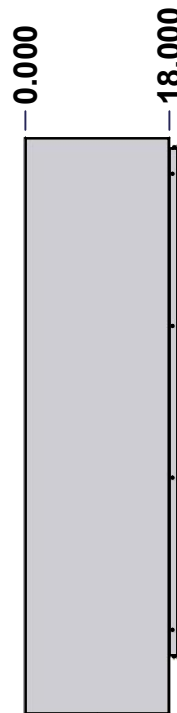

LEFT

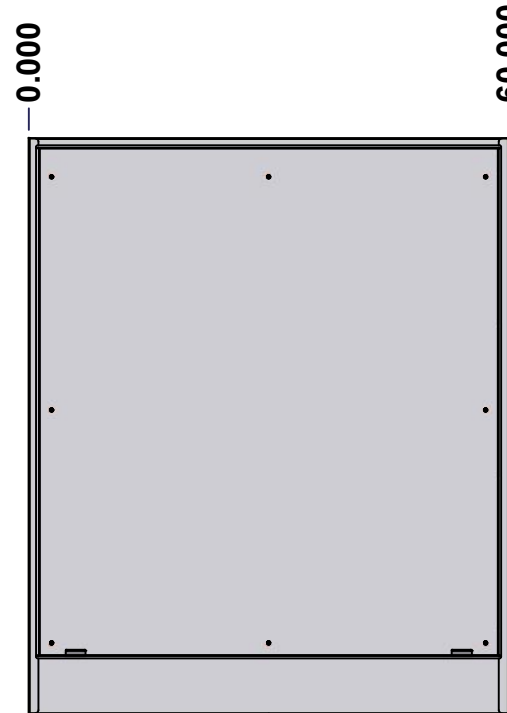

FRONT

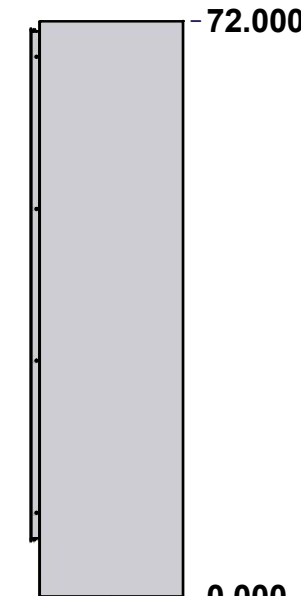

RIGHT



BOTTOM

No.	Revisions	Date	By/Par
0.1	Update to latest design in BOXCAD	2022/10/8	Hunter
0.2	update hinge to STK-A-33012	2022/11/29	Zin

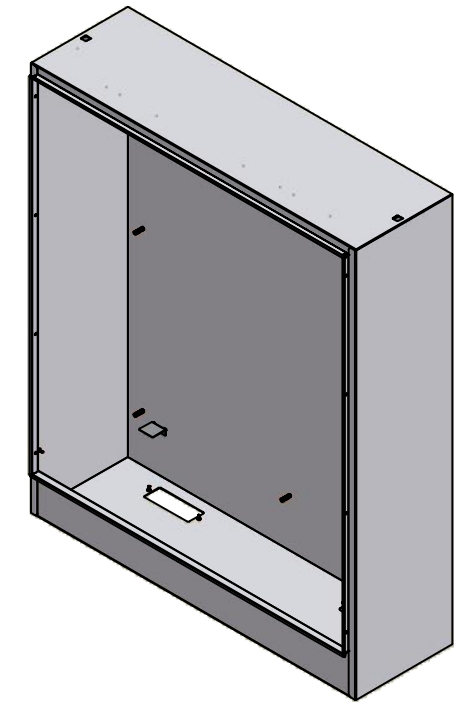

Isometric View



Tél: (450) 979-4373
 Fax: (450) 979-4626
www.exmweb.com

Flatness
Aplatissement

Max 3.0mm

Projection



Customer Client	Date
Drawn By Dessiné Par BoxCad: BoxCad	Date 12/7/2021
Material Matière 12 Ga Cold Rolled A1008 CS Type B (2.5mm)	
Color Couleur Asa-61 Grey	Finish Fini Smooth
Description 9500DD 72" x 60" x 18" Body	Detail Rev.
Part Number Numéro Pièce 9500STDD726018B	Rev. 3 0

SEE BILL OF MATERIAL ON LAST PAGE

This drawing is confidential and must not be reproduced or used without the consent of EXM

Ce dessin est confidentiel et ne doit pas être reproduit ou utilisé sans le consentement de EXM

STANDARD FEATURES ARE NOT LISTED IN THIS HOLE TABLE

HOLE TABLE - TOP VIEW (CUSTOM FEATURE ONLY)

CUT-OUT	XDIM	YDIM	DESCRIPTION
1	14.911	13.911	Struts CR400 21.500" (Inside)
2	44.911	13.911	Struts CR400 21.500" (Inside)
3	14.911	13.911	STUDS M6 x 10mm (Inside)
4	7.161	13.911	STUDS M6 x 10mm (Inside)
5	22.661	13.911	STUDS M6 x 10mm (Inside)
6	44.911	13.911	STUDS M6 x 10mm (Inside)
7	37.161	13.911	STUDS M6 x 10mm (Inside)
8	52.661	13.911	STUDS M6 x 10mm (Inside)

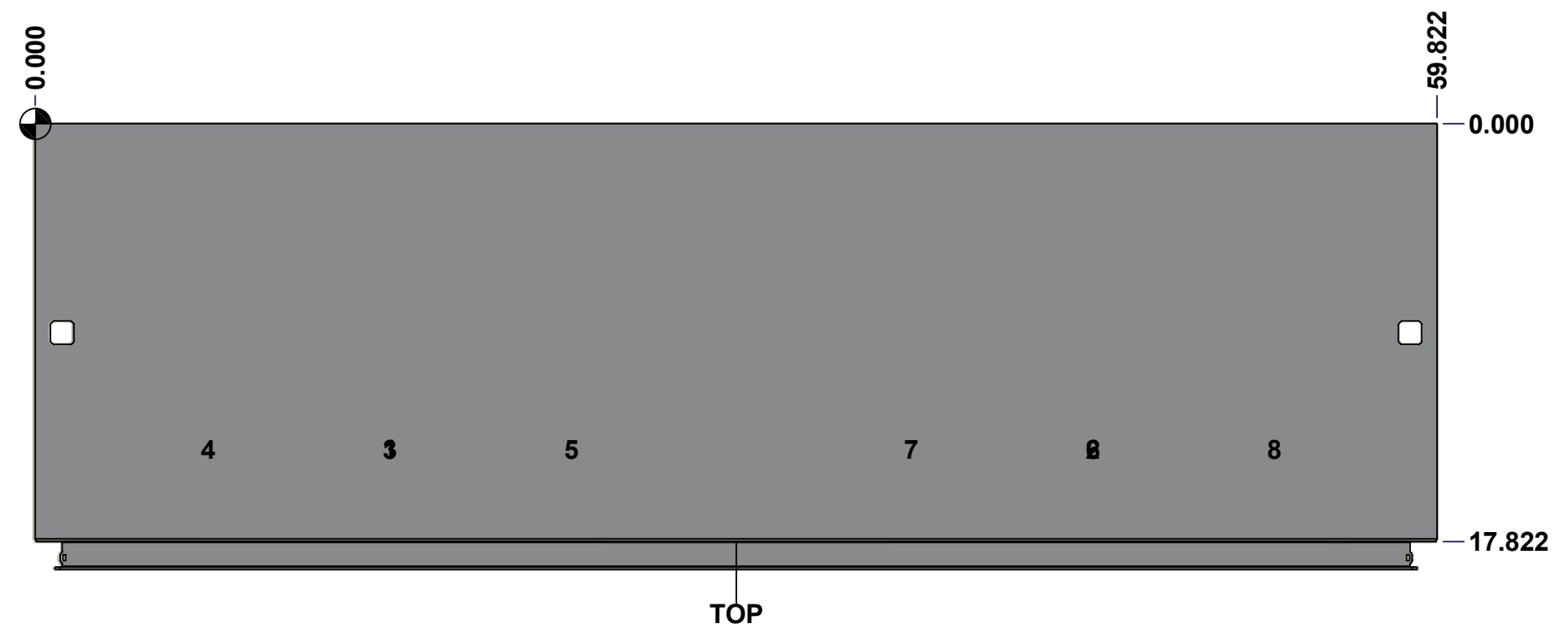

	Description	Status
	9500DD 72" x 60" x 18" Body	(NULL)
	Part Number Numéro Pièce	Rev.
	9500STDD726018B	0 / 4
		15

This drawing is confidential and must not be reproduced or used without the consent of EXM

Ce dessin est confidentiel et ne doit pas être reproduit ou utilisé sans le consentement de EXM

STANDARD FEATURES ARE NOT LISTED IN THIS HOLE TABLE			
HOLE TABLE - RIGHT VIEW (CUSTOM FEATURE ONLY)			
CUT-OUT	XDIM	YDIM	DESCRIPTION
1	16.411	9.286	GND STUD M6 x 16mm (Inside)

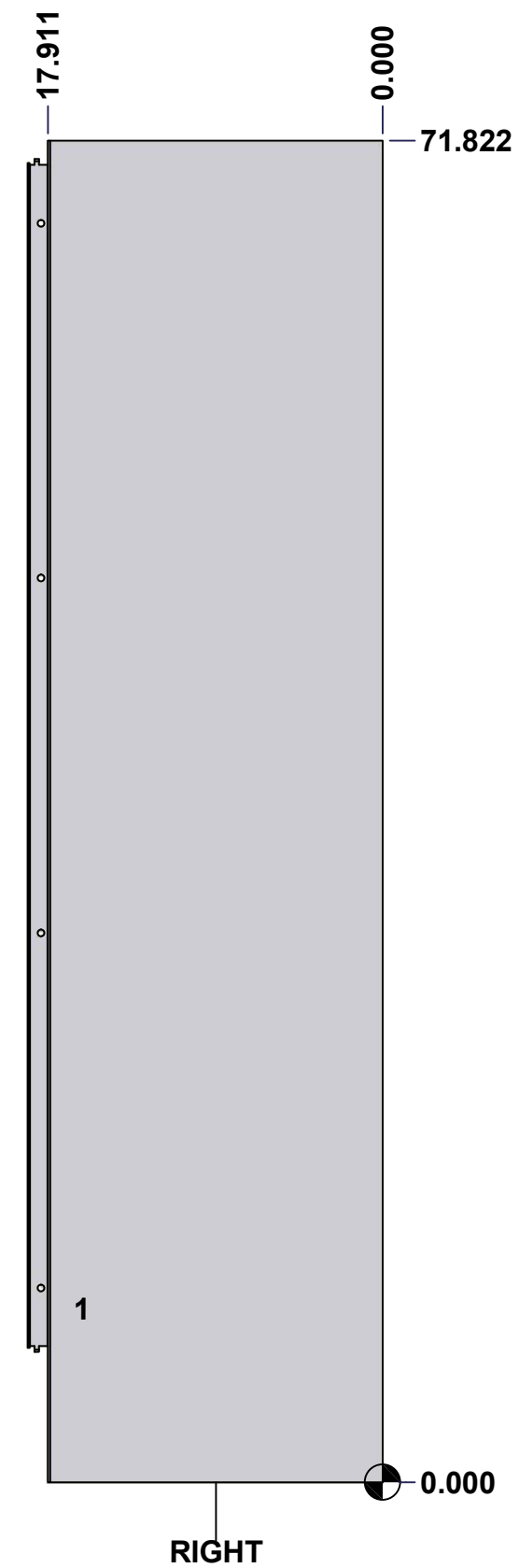

RIGHT

	Description		Status
	9500DD 72" x 60" x 18" Body		(NULL)
Part Number Numéro Pièce		Rev.	5
9500STDD726018B		0	15

This drawing is confidential and must not be reproduced or used without the consent of EXM

Ce dessin est confidentiel et ne doit pas être reproduit ou utilisé sans le consentement de EXM

STANDARD FEATURES ARE NOT LISTED IN THIS HOLE TABLE			
HOLE TABLE - BOTTOM VIEW (CUSTOM FEATURE ONLY)			
CUT-OUT	XDIM	YDIM	DESCRIPTION
1	7.286	3.411	GP STUD M6 x 16mm (Inside)
2	16.536	3.411	GP STUD M6 x 16mm (Inside)
3	43.286	3.411	GP STUD M6 x 16mm (Inside)
4	52.536	3.411	GP STUD M6 x 16mm (Inside)

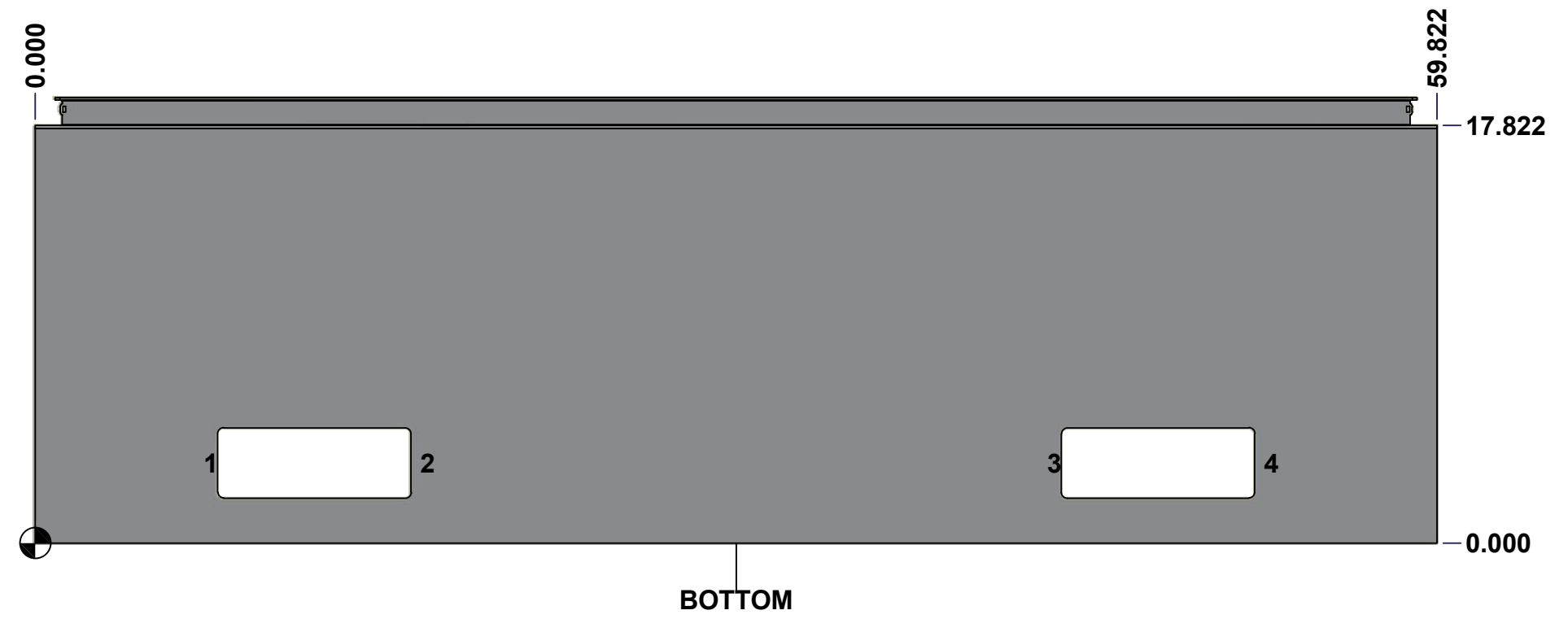

	Description	Status
	9500DD 72" x 60" x 18" Body	(NULL)
	Part Number Numéro Pièce	Rev.
	9500STDD726018B	0 / 6
		15

This drawing is confidential and must not be reproduced or used without the consent of EXM

Ce dessin est confidentiel et ne doit pas être reproduit ou utilisé sans le consentement de EXM

STANDARD FEATURES ARE NOT LISTED IN THIS HOLE TABLE			
HOLE TABLE - LEFT VIEW (CUSTOM FEATURE ONLY)			
CUT-OUT	XDIM	YDIM	DESCRIPTION
1	16.411	9.286	GND STUD M6 x 16mm (Inside)

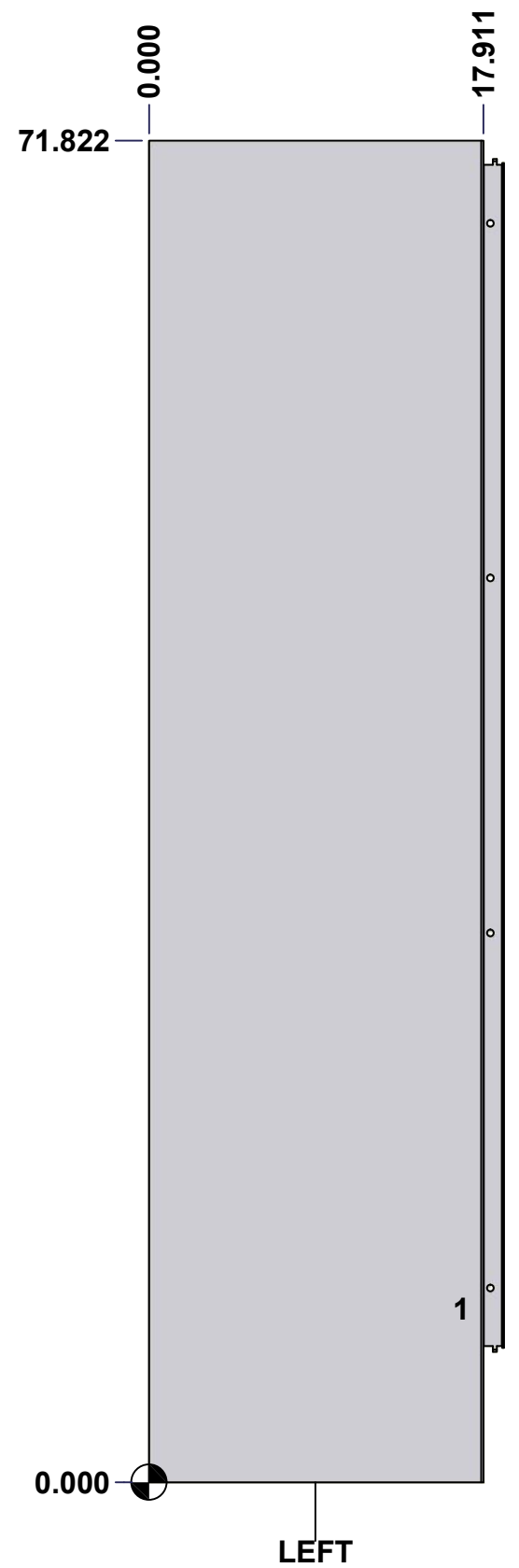

	Description	Status	
	9500DD 72" x 60" x 18" Body	(NULL)	
	Part Number Numéro Pièce	Rev.	7
	9500STDD726018B	0	15

This drawing is confidential and must not be reproduced or used without the consent of EXM

Ce dessin est confidentiel et ne doit pas être reproduit ou utilisé sans le consentement de EXM

STANDARD FEATURES ARE NOT LISTED IN THIS HOLE TABLE

HOLE TABLE - BACK VIEW (CUSTOM FEATURE ONLY)

CUT-OUT	XDIM	YDIM	DESCRIPTION
1	2.786	8.786	IP STUD M10 x 40mm (Inside)
2	57.036	8.786	IP STUD M10 x 40mm (Inside)
3	2.786	37.911	IP STUD M10 x 40mm (Inside)
4	57.036	37.911	IP STUD M10 x 40mm (Inside)
5	2.786	67.036	IP STUD M10 x 40mm (Inside)
6	57.036	67.036	IP STUD M10 x 40mm (Inside)
7	29.911	8.786	IP STUD M10 x 40mm (Inside)
8	29.911	67.036	IP STUD M10 x 40mm (Inside)
-----	-----	-----	-----
9	54.036	7.411	IP SUPPORT ANGLE (Inside)
10	5.786	7.411	IP SUPPORT ANGLE (Inside)

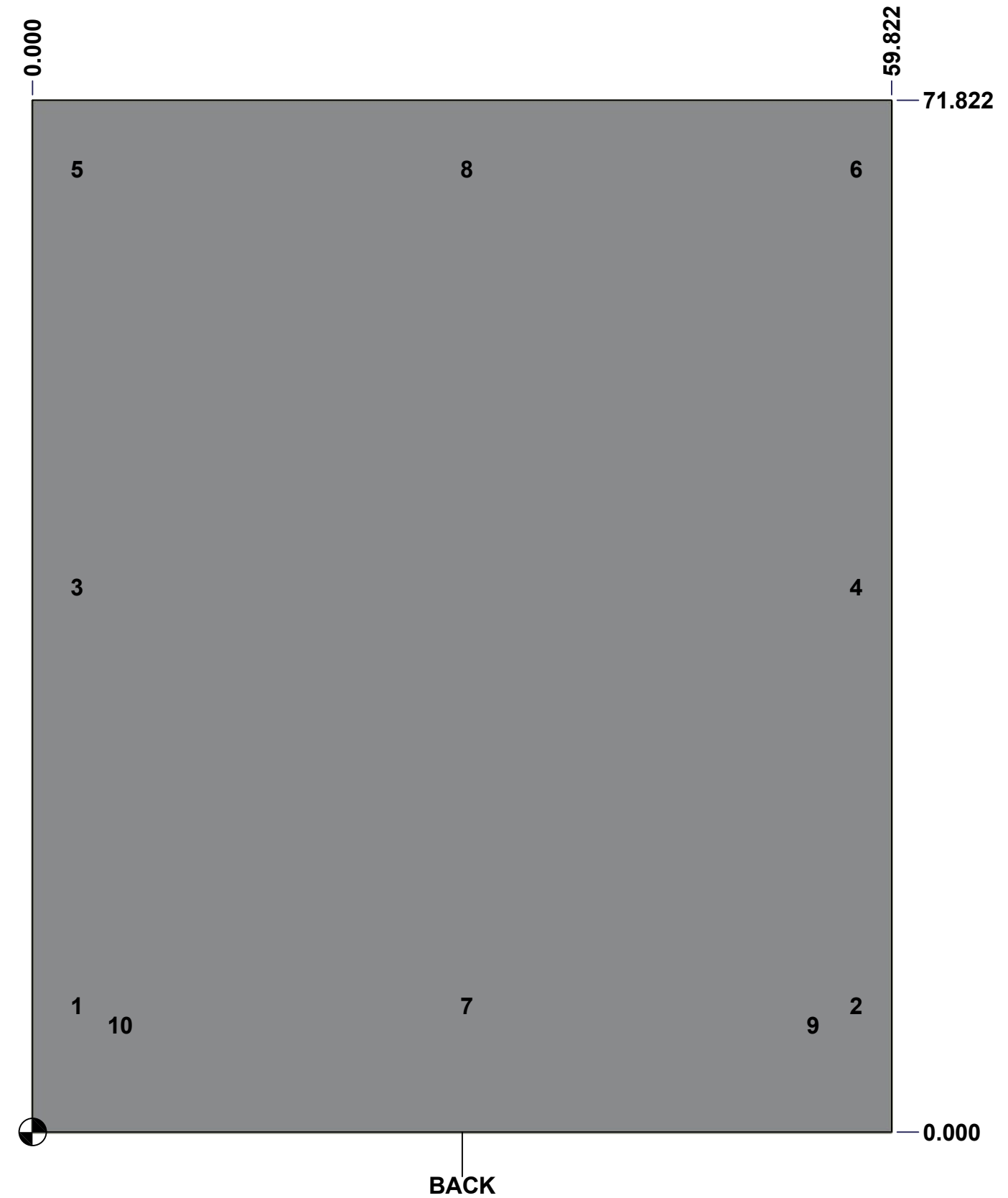

	Description	Status
	9500DD 72" x 60" x 18" Body	(NULL)
	Part Number Numéro Pièce	Rev.
	9500STDD726018B	0 / 8
		15

This drawing is confidential and must not be reproduced or used without the consent of EXM

Ce dessin est confidentiel et ne doit pas être reproduit ou utilisé sans le consentement de EXM

No.	Revisions	Date	By/Par
0.1	Update to latest design in BOXCAD	2022/10/8	Hunter
0.2	update hinge to STK-A-33012	2022/11/29	Zin

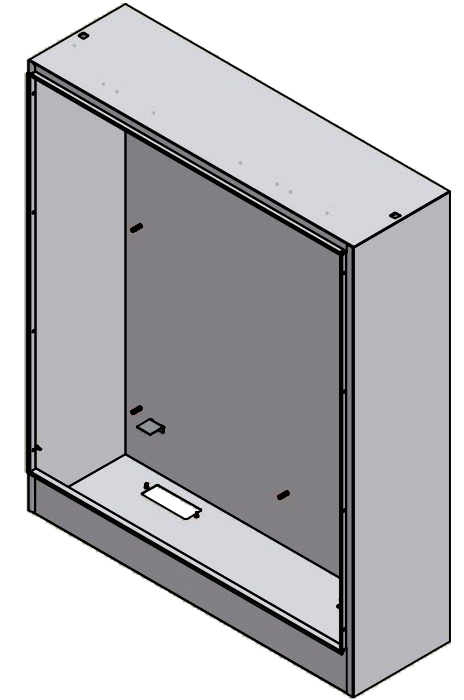

Isometric View



6	STK-Q-16030	0	Stud M6 x 10mm
2	9500STDD726018BPA-P	0	9500DD Inner Panel Support Angle
6	STK-Q-07220	1	M6 Nylon Insert Lock Nut
2	STK-Q-74900	0	Eyebolt Lifting Angle (8.750")
1	STK-P-02400S	0	Powder Paint (Asa-61 Grey / Smooth)
8	STK-Q-16100	0	Stud M10 x 40mm
1	9500STDD726018BT-P	0	9500DD 60" x 18" Bottom Part
1	9500STDD726018T-P	0	9500DD 60" x 18" Top Part
1	9500STDD726018RS-P	0	9500DD 72" x 60" Right Part
1	9500STDD726018LS-P	0	9500DD 72" x 60" Left Part
1	9500STDD726018B-P	0	9500DD 72" x 60" Back Part
2	CR400MS_21.5	0	Commercial Roll Mild Steel (21.5in long)
6	STK-Q-16080	0	Ground Stud M6 x 16mm
Qty	Part Number	Rev	Description
Parts List			

<p>Tél: (450) 979-4373 Fax: (450) 979-4626 www.exmweb.com</p>	Flatness Aplatissement	Max 3.0mm
	Projection	
Customer Client	Date	
Drawn By Dessiné Par	BoxCad: BoxCad	Date 12/7/2021
Material Matière	12 Ga Cold Rolled A1008 CS Type B (2.5mm)	
Color Couleur	Asa-61 Grey	Finish Fini Smooth
Description	Detail Rev.	
9500DD 72" x 60" x 18" Body		
Part Number Numéro Pièce	Rev.	9
9500STDD726018B	0	15

This drawing is confidential and must not be reproduced or used without the consent of EXM

Ce dessin est confidentiel et ne doit pas être reproduit ou utilisé sans le consentement de EXM

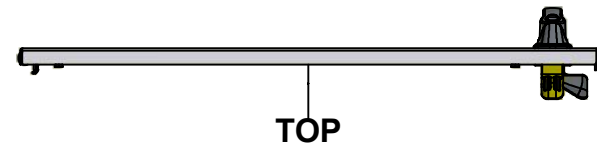

TOP

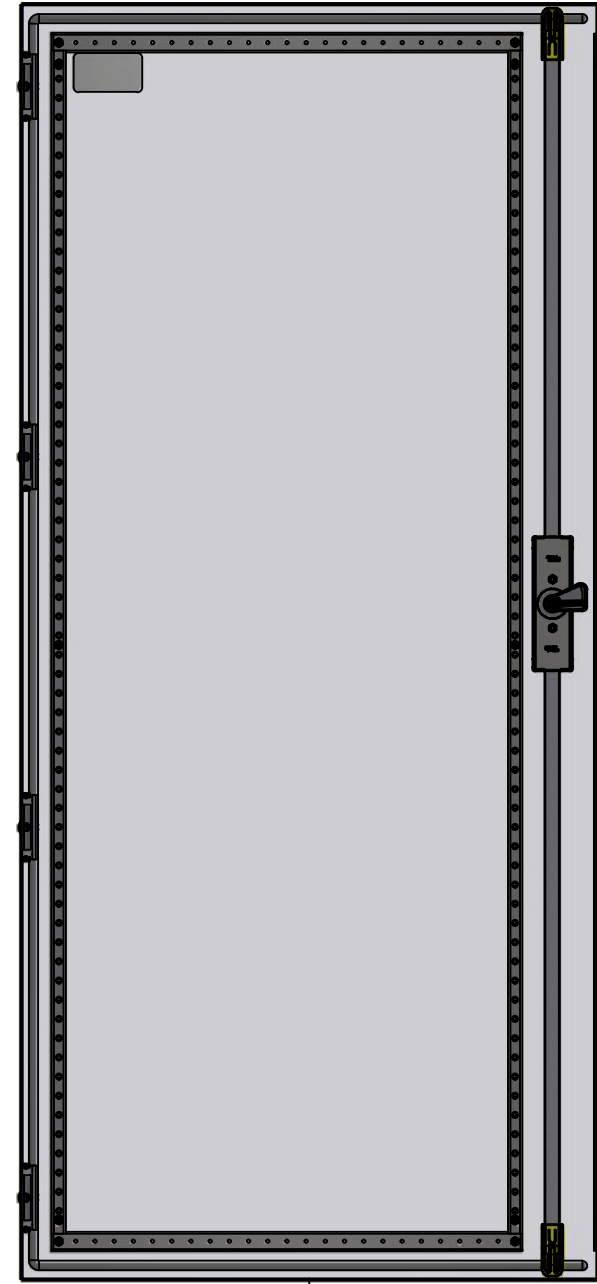

BACK

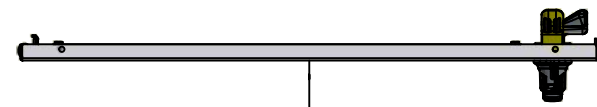

BOTTOM

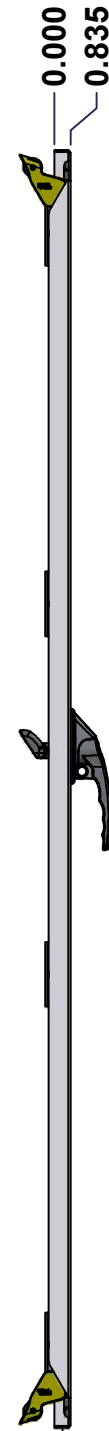

LEFT

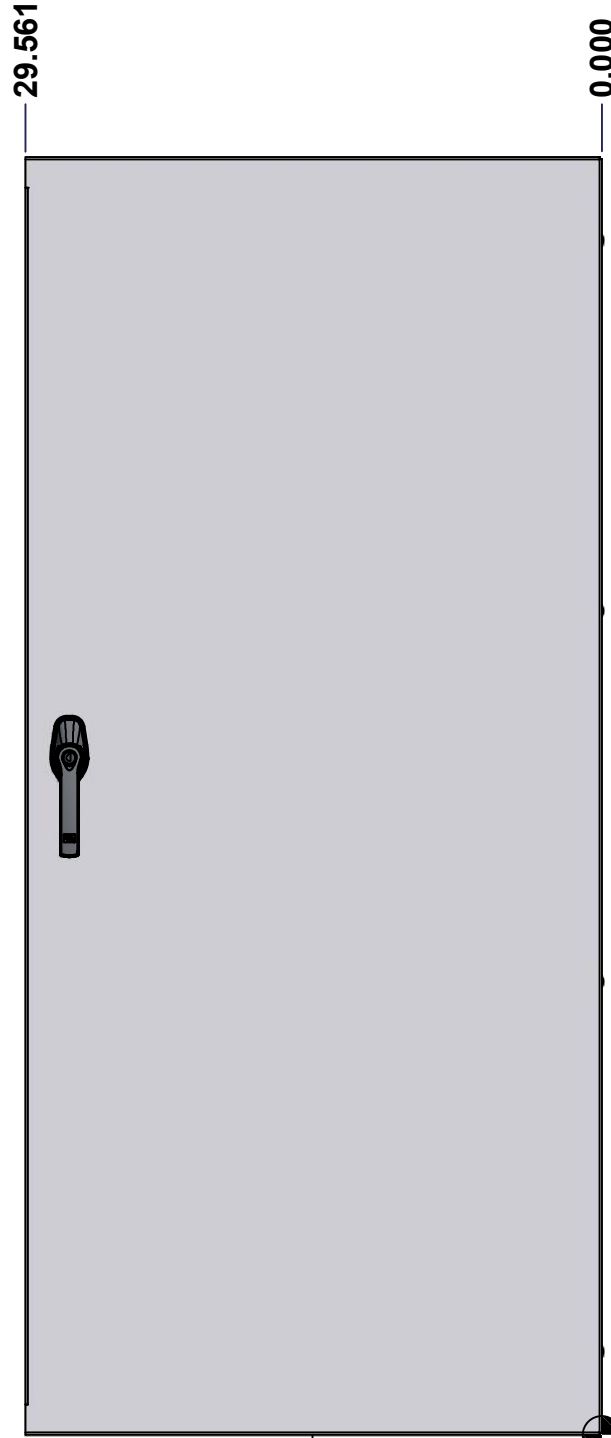

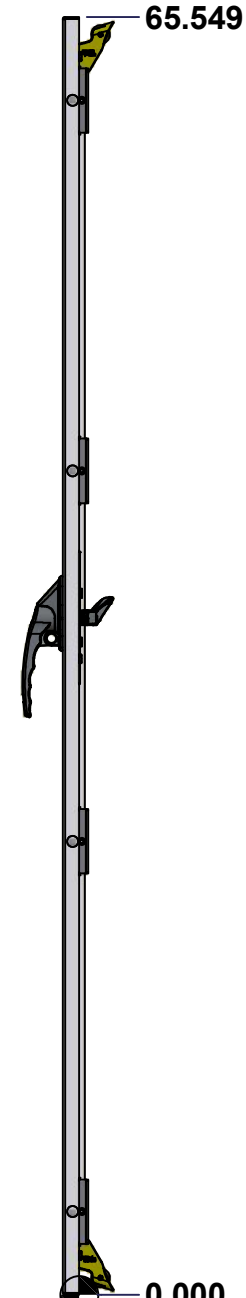

FRONT

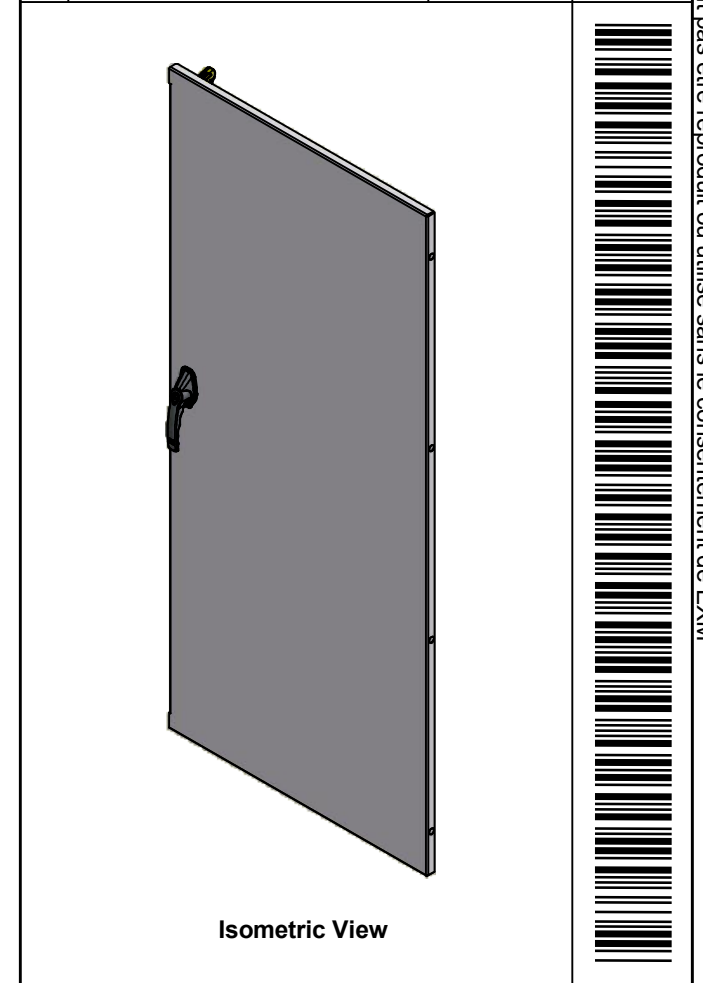

RIGHT

No.	Revisions	Date	By/Par
0.1	Update to latest design in BOXCAD	2022/10/8	Hunter
0.2	update hinge to STK-A-33012	2022/11/29	Zin



 Tél: (450) 979-4373 Fax: (450) 979-4626 www.exmweb.com		Flatness Aplatissement
		Max 3.0mm
Customer Client		Date
Drawn By Dessiné Par BoxCad: BoxCad		Date 12/7/2021
Material Matière 12 Ga Cold Rolled A1008 CS Type B (2.5mm)		
Color Couleur Asa-61 Grey	Finish Fini Smooth	
Description 9500DD 72" x 60" Lock Door		Detail Rev.
Part Number Numéro Pièce 9500STDD726018LD		Rev. 10 0

SEE BILL OF MATERIAL ON LAST PAGE

This drawing is confidential and must not be reproduced or used without the consent of EXM

Ce dessin est confidentiel et ne doit pas être reproduit ou utilisé sans le consentement de EXM

STANDARD FEATURES ARE NOT LISTED IN THIS HOLE TABLE

HOLE TABLE - FRONT VIEW (CUSTOM FEATURE ONLY)

CUT-OUT	XDIM	YDIM	DESCRIPTION
1	1.983	2.028	STUD M6 x 18mm (Inside)
2	1.983	32.628	STUD M6 x 18mm (Inside)
3	1.983	63.521	STUD M6 x 18mm (Inside)
4	1.983	3.139	STUD M6 x 18mm (Inside)
5	1.983	62.409	STUD M6 x 18mm (Inside)
6	25.390	2.028	STUD M6 x 18mm (Inside)
7	25.390	32.628	STUD M6 x 18mm (Inside)
8	25.390	63.521	STUD M6 x 18mm (Inside)
9	25.390	3.139	STUD M6 x 18mm (Inside)
10	25.390	62.409	STUD M6 x 18mm (Inside)
11	27.311	6.118	CLOSING BAR STUD (Inside)
12	27.311	59.430	CLOSING BAR STUD (Inside)
-----	-----	-----	-----
13	27.311	34.743	HANDLE 885 ESL2A-APHK @ 0.0°

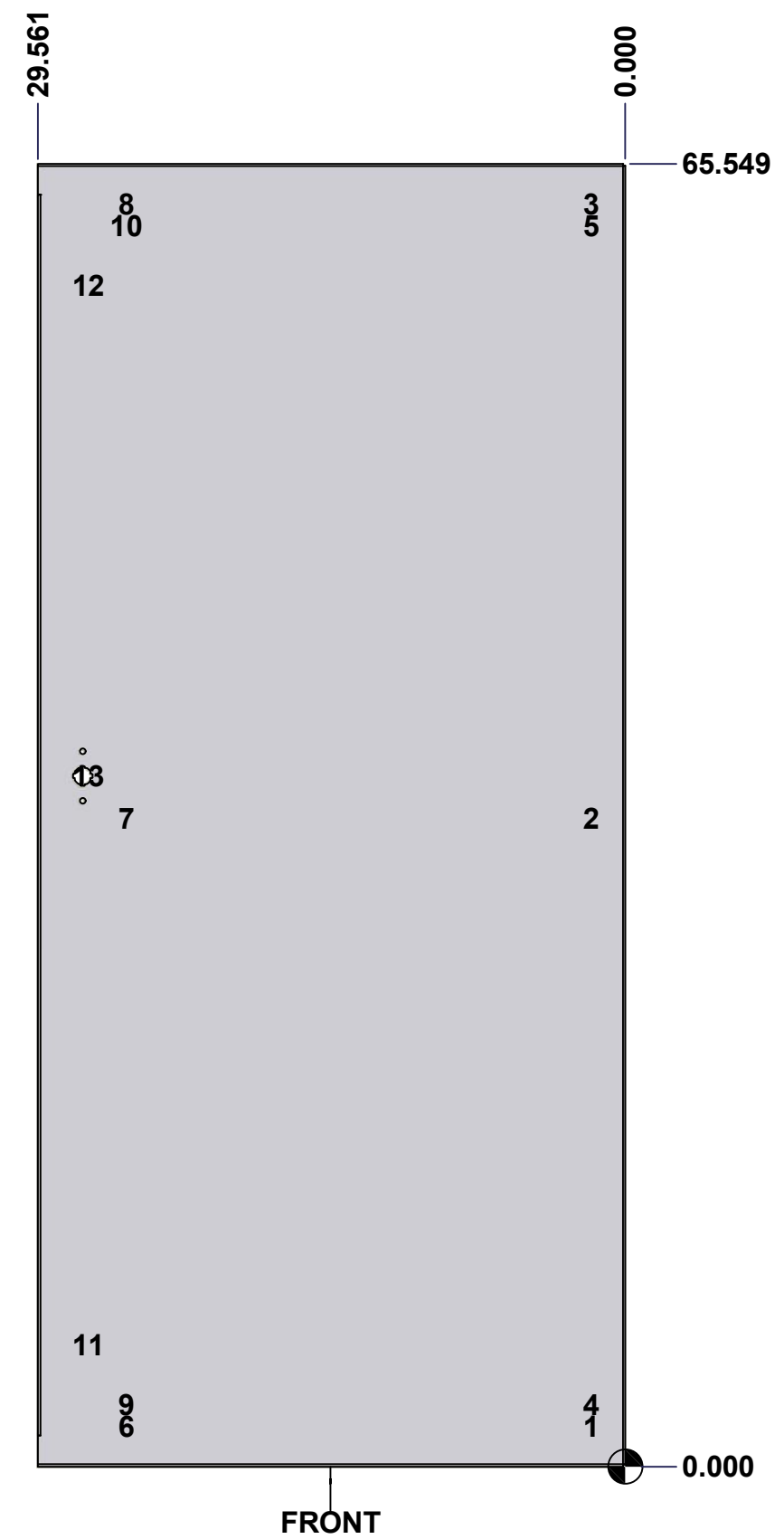

FRONT

	Description	Status
	9500DD 72" x 60" Lock Door	(NULL)
	Part Number Numéro Pièce	Rev.
	9500STDD726018LD	0
		11
		15

This drawing is confidential and must not be reproduced or used without the consent of EXM

Ce dessin est confidentiel et ne doit pas être reproduit ou utilisé sans le consentement de EXM

No.	Revisions	Date	By/Par
0.1	Update to latest design in BOXCAD	2022/10/8	Hunter
0.2	update hinge to STK-A-33012	2022/11/29	Zin

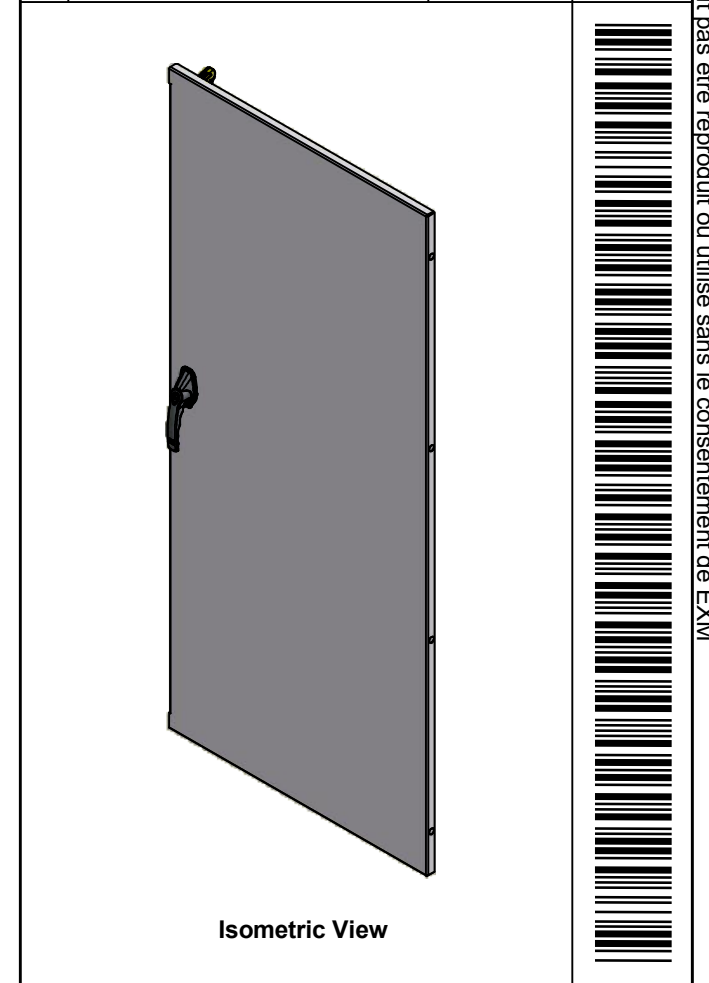

4	STK-Q-00260-NT	1	M6 x 13mm Carriage Bolt
4	STK-Q-07220	1	M6 Nylon Insert Lock Nut
4	STK-A-33012	3	5500 SSDD - Stainless Steel Sheet Metal Hinge Assembly
1	STK-Q-47527	2	9500 Lower Closing Bar 72"
1	STK-Q-47517	2	9500 Upper Closing Bar 72"
1	STK-A-03986-36	2	Gearbox Counterclockwise Assembly (36.0mm)
1	885ESL2A-APHK	6	885 ESL2A-APHK - Zinc Die Cast L-Handle Padlockable Assy
1	STK-P-02400S	0	Powder Paint (Asa-61 Grey / Smooth)
1	STK-S-00100	0	3.5" x 2" Silver Milar Flexcon Sticker
1	9500STDD726018LDG	0	9500DD 72" x 60" Lock Door Gasket
1	STK-K-10840	3	9500 - Door Stiffener Assembly
2	STK-Q-16410	0	Guide Stud - Largel (No Paint Cap Required)
10	STK-Q-16055	1	M6 x 18mm Stud (No Paint Cap Required)
1	9500STDD726018LD-P	0	9500DD 72" x 60" Lock Door Part
2	STK-A-90025	0	9500 - Cabinet Closing Bar End (Large)
Qty	Part Name	Rev	Description
Parts List			

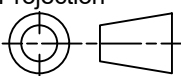
 Tél: (450) 979-4373 Fax: (450) 979-4626 www.exmweb.com		Flatness Aplatissement
		Max 3.0mm
Customer Client		Date
Drawn By Dessiné Par BoxCad: BoxCad		Date 12/7/2021
Material Matière 12 Ga Cold Rolled A1008 CS Type B (2.5mm)		Projection 
Color Couleur Asa-61 Grey	Finish Fini Smooth	Detail Rev.
Description 9500DD 72" x 60" Lock Door		
Part Number Numéro Pièce 9500STDD726018LD		Rev. 0
		12 / 15

This drawing is confidential and must not be reproduced or used without the consent of EXM

Ce dessin est confidentiel et ne doit pas être reproduit ou utilisé sans le consentement de EXM



TOP

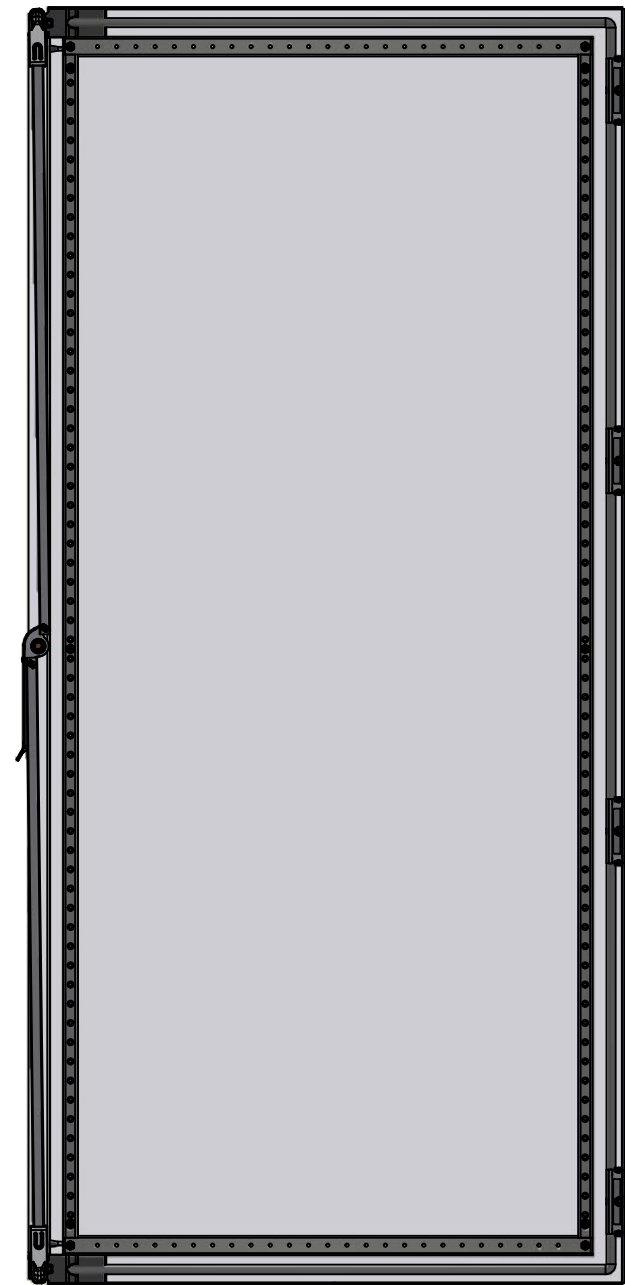

BACK



BOTTOM

0.000
0.835

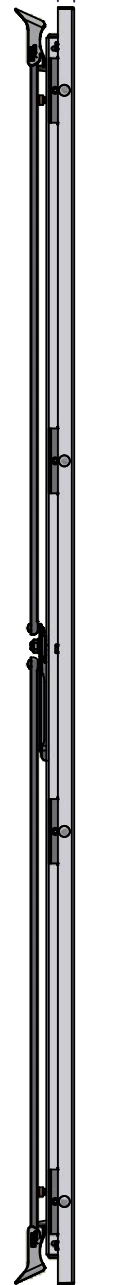

LEFT

0.000

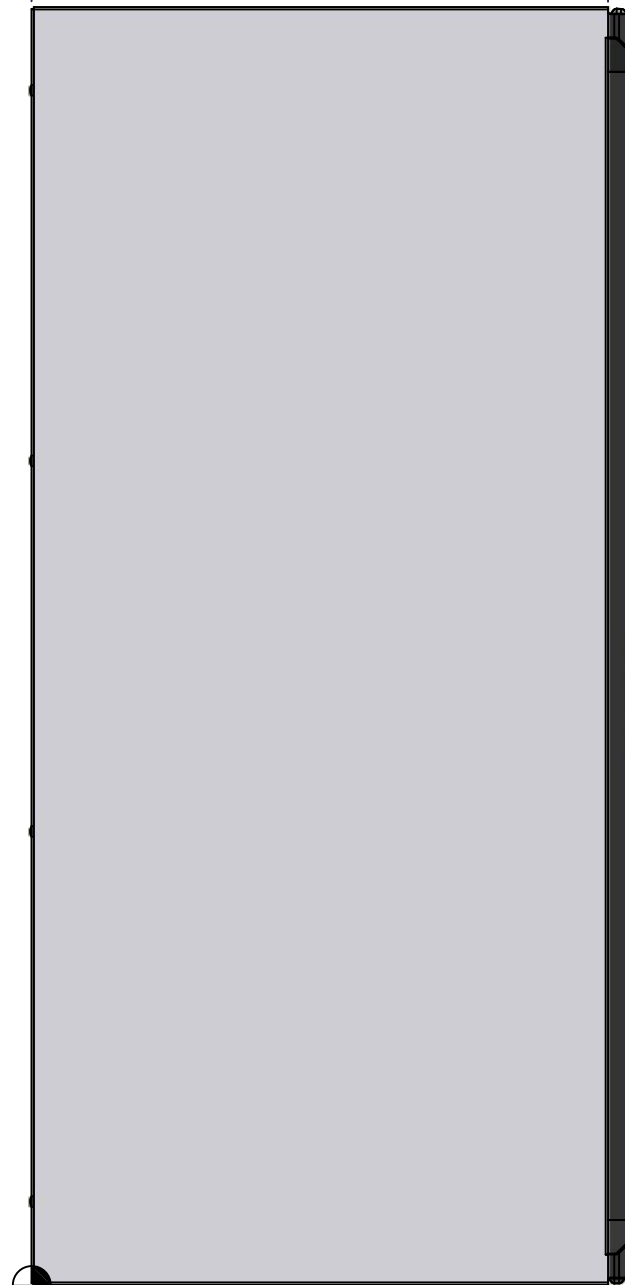

FRONT

29.561

65.549

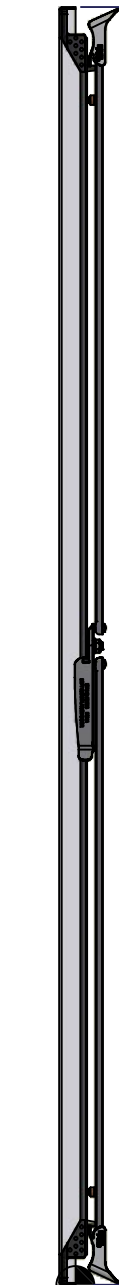

RIGHT

0.000

No.	Revisions	Date	By/Par
0.1	Update to latest design in BOXCAD	2022/10/8	Hunter
0.2	update hinge to STK-A-33012	2022/11/29	Zin

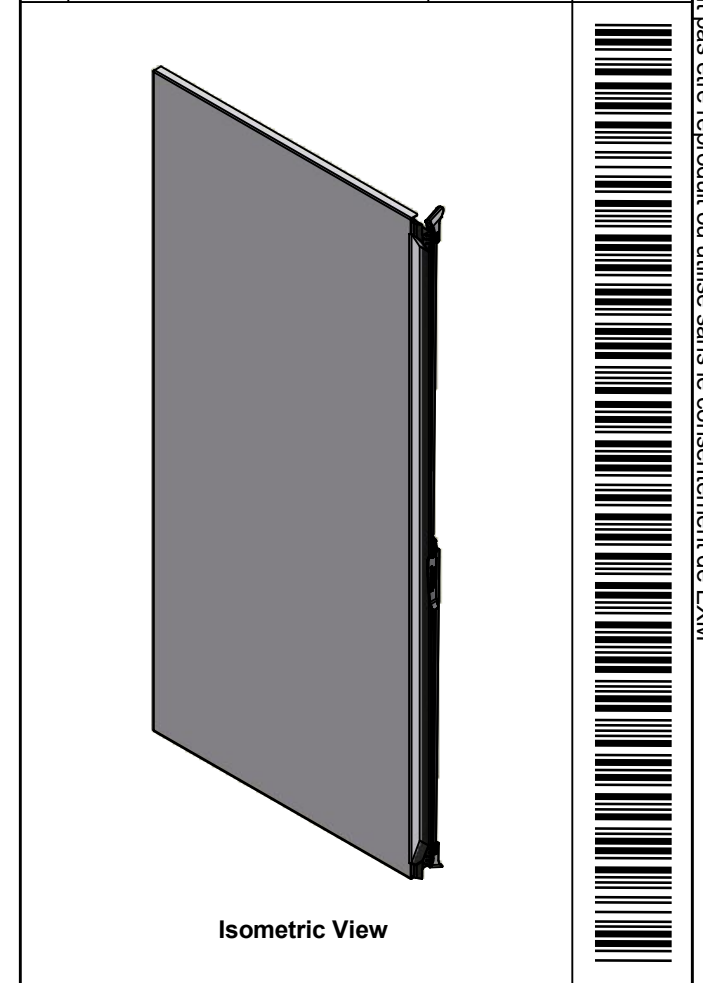

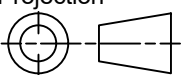
 Tél: (450) 979-4373 Fax: (450) 979-4626 www.exmweb.com		Flatness Aplatissement Max 3.0mm Projection 
Customer Client	Date	
Drawn By Dessiné Par	BoxCad: BoxCad	Date 12/7/2021
Material Matière	12 Ga Cold Rolled A1008 CS Type B (2.5mm)	
Color Couleur	Asa-61 Grey	Finish Fini Smooth
Description	Detail Rev.	
9500DD 72" x 60" Flange Door		
Part Number Numéro Pièce	Rev.	13
9500STDD726018FD	0	15

SEE BILL OF MATERIAL ON LAST PAGE

This drawing is confidential and must not be reproduced or used without the consent of EXM

Ce dessin est confidentiel et ne doit pas être reproduit ou utilisé sans le consentement de EXM

STANDARD FEATURES ARE NOT LISTED IN THIS HOLE TABLE

HOLE TABLE - FRONT VIEW (CUSTOM FEATURE ONLY)

CUT-OUT	XDIM	YDIM	DESCRIPTION
1	2.000	2.028	STUD M6 x 18mm (Inside)
2	2.000	32.628	STUD M6 x 18mm (Inside)
3	2.000	63.521	STUD M6 x 18mm (Inside)
4	2.000	3.139	STUD M6 x 18mm (Inside)
5	2.000	62.409	STUD M6 x 18mm (Inside)
6	28.407	2.028	STUD M6 x 18mm (Inside)
7	28.407	32.628	STUD M6 x 18mm (Inside)
8	28.407	63.521	STUD M6 x 18mm (Inside)
9	28.407	3.139	STUD M6 x 18mm (Inside)
10	28.407	62.409	STUD M6 x 18mm (Inside)
11	30.061	4.774	CLOSING BAR GUIDE (Inside)
12	30.061	60.774	CLOSING BAR GUIDE (Inside)
13	30.061	32.774	STUD M10 x 20mm (Inside)

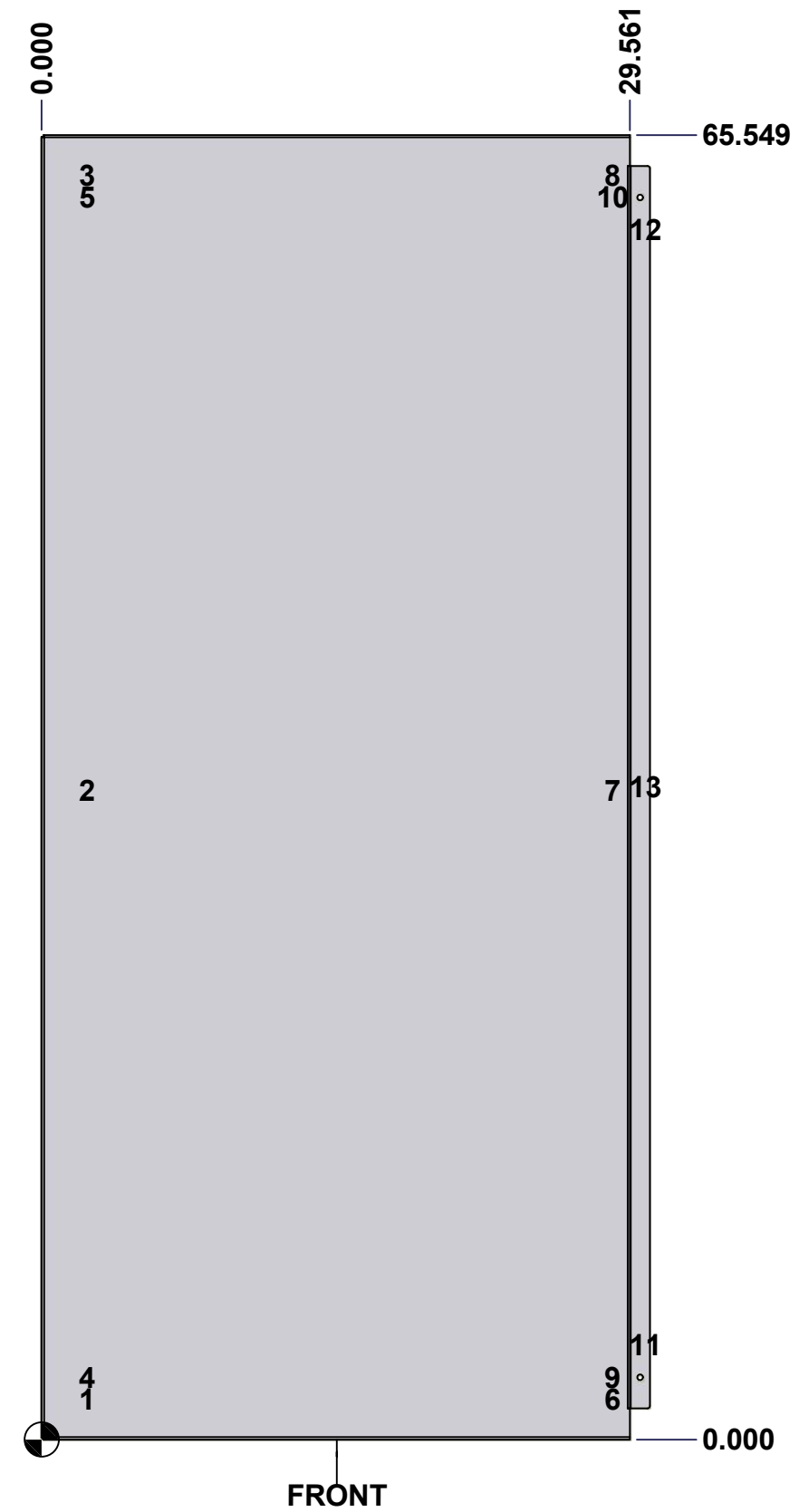

FRONT

	Description	Status
	9500DD 72" x 60" Flange Door	(NULL)
	Part Number Numéro Pièce	Rev.
	9500STDD726018FD	0 / 14
		15

This drawing is confidential and must not be reproduced or used without the consent of EXM

Ce dessin est confidentiel et ne doit pas être reproduit ou utilisé sans le consentement de EXM

No.	Revisions	Date	By/Par
0.1	Update to latest design in BOXCAD	2022/10/8	Hunter
0.2	update hinge to STK-A-33012	2022/11/29	Zin

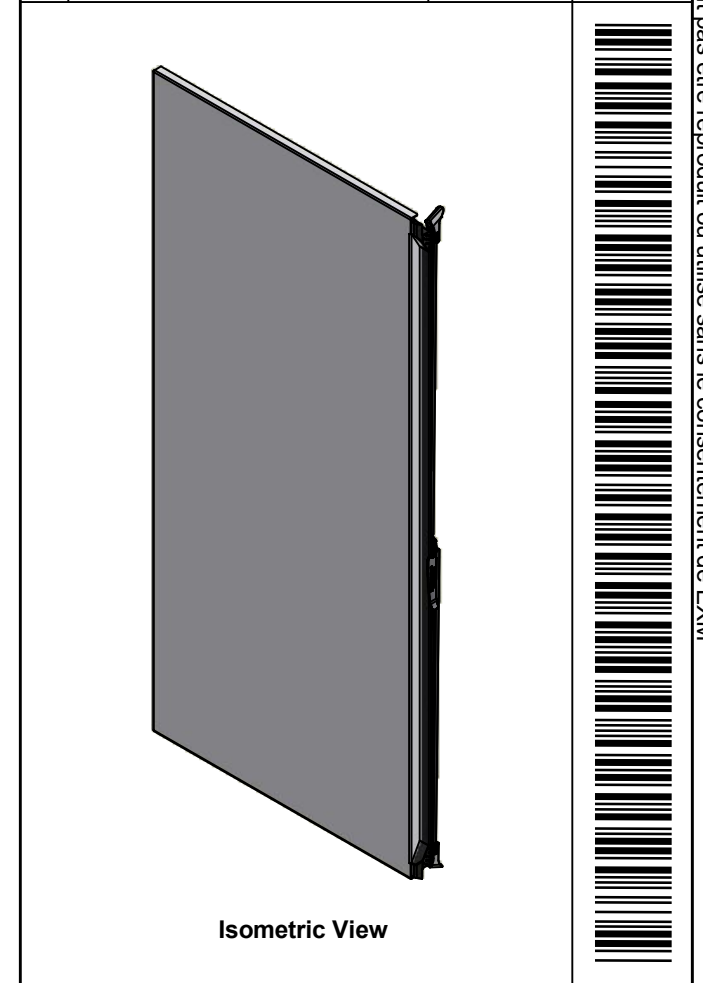

4	STK-Q-00260-NT	1	M6 x 13mm Carriage Bolt
4	STK-Q-07220	1	M6 Nylon Insert Lock Nut
4	STK-A-33012	3	5500 SSDD - Stainless Steel Sheet Metal Hinge Assembly
1	STK-P-02400S	0	Powder Paint (Asa-61 Grey / Smooth)
1	STK-G-03400	0	5500 DD Lower Flange Door Gasket
1	STK-G-03300	0	5500 DD Upper Flange Door Gasket
2	STK-Q-90045	0	Cabinet - Closing Bar End
2	STK-Q-45660-72	2	9500 DD - Flange Door Closing Bar
1	STK-K-50556	4	9500 DD - Flange Door Handle Assy
1	STK-K-20840	3	9500 - Flange Door Stiffener Assembly
1	STK-Q-16122	1	Stud M10 x 20mm
1	STK-G-00701	0	1" x 1/4" Self-Adhesive Neoprene Gasket
1	9500STDD726018FDG	0	9500DD 72" x 60" Flange Door Gasket
2	STK-Q-16405	6	Guide Stud - Small (No Paint Cap Required)
10	STK-Q-16055	1	M6 x 18mm Stud (No Paint Cap Required)
1	9500STDD726018FD-P	0	9500DD 72" x 60" Flange Door Part

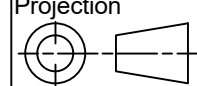
 Tél: (450) 979-4373 Fax: (450) 979-4626 www.exmweb.com	Flatness Aplatissement
	Max 3.0mm
Projection	
Customer Client	Date
Drawn By Dessiné Par	Date 12/7/2021
Material Matière	12 Ga Cold Rolled A1008 CS Type B (2.5mm)
Color Couleur	Asa-61 Grey
Finish Fini	Smooth
Description	Detail Rev.
9500DD 72" x 60" Flange Door	
Part Number Numéro Pièce	Rev. 15
9500STDD726018FD	0 / 15

Qty	Part Name	Rev	Description
Parts List			