

This drawing is confidential and must not be reproduced or used without the consent of EXM

Ce dessin est confidentiel et ne doit pas être reproduit ou utilisé sans le consentement de EXM

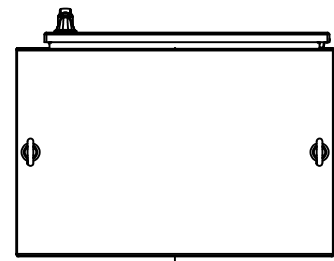

TOP

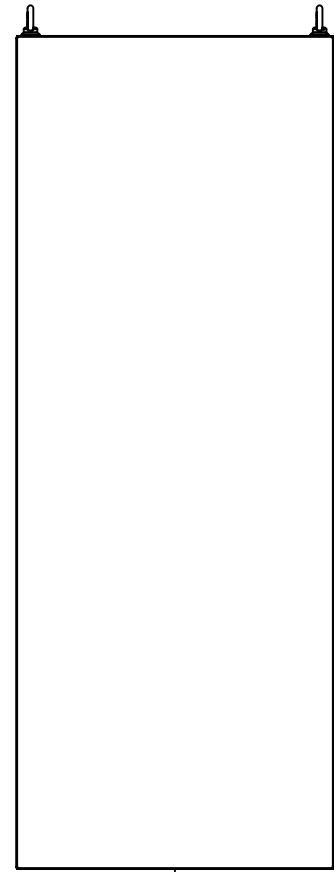

BACK

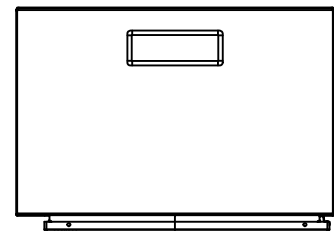

BOTTOM

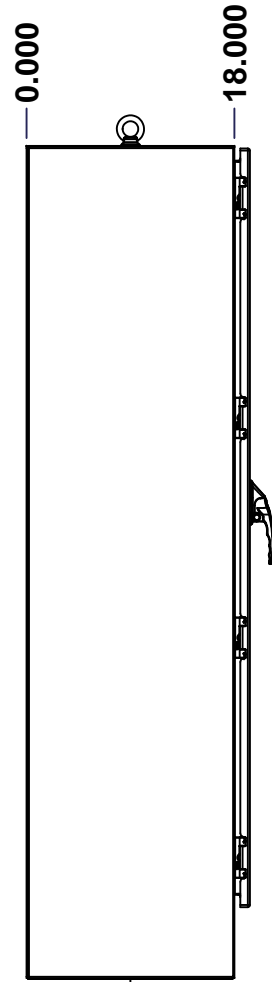

LEFT

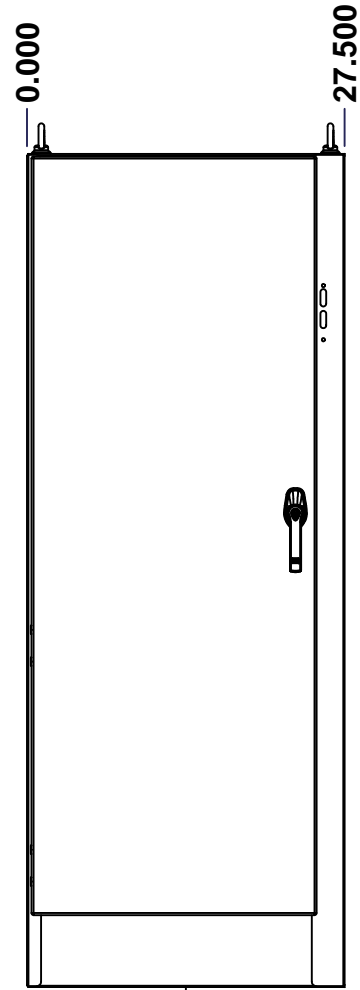

FRONT

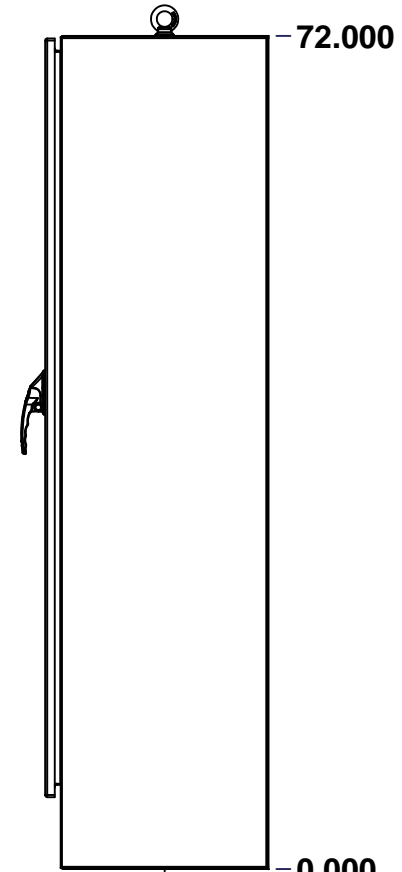

RIGHT

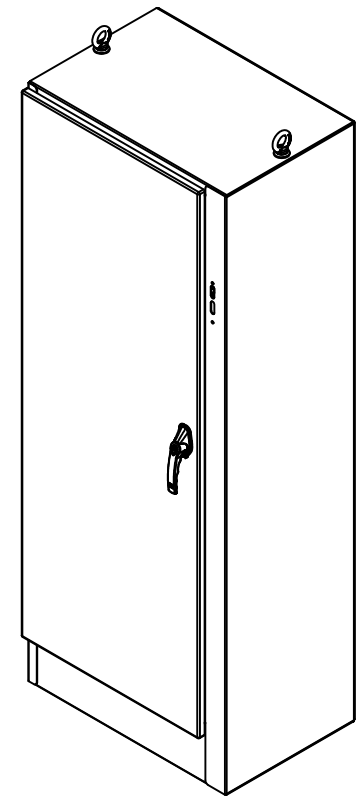

Isometric View

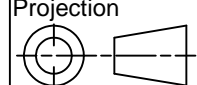

No.	Revisions	Date	By/Par

 Tél: (450) 979-4373 Fax: (450) 979-4626 www.exmweb.com		Flatness Aplatissement Max 3.0mm Projection 
Customer Client	Date	
Drawn By Dessiné Par	BoxCad: BoxCad	Date 04-Nov-14
Material Matière	12 Ga Cold Rolled A1008 CS Type B (2.5mm)	
Color Couleur	Asa-61 Grey	Finish Fini Smooth
Description	Detail Rev.	
9500U1D 72" x 27.5" x 18" Assembly		
Part Number Numéro Pièce	Rev. 0	1 / 2
9500U1D722818		

SEE BILL OF MATERIAL ON LAST PAGE

This drawing is confidential and must not be reproduced or used without the consent of EXM

Ce dessin est confidentiel et ne doit pas être reproduit ou utilisé sans le consentement de EXM

NOTE	
ITEM	DESCRIPTION
1	NEMA 12/13 Enclosure
2	C/W Standard ground studs on box and cover
3	C/W Standard door stiffener
4	C/W Special inner panel (Sold separately)
5	C/W Standard inner panel mounting studs
6	C/W Eyebolts
7	C/W Struts installed (Included)
8	C/W Special handle sold separately (Kit)

No.	Revisions	Date	By/Par

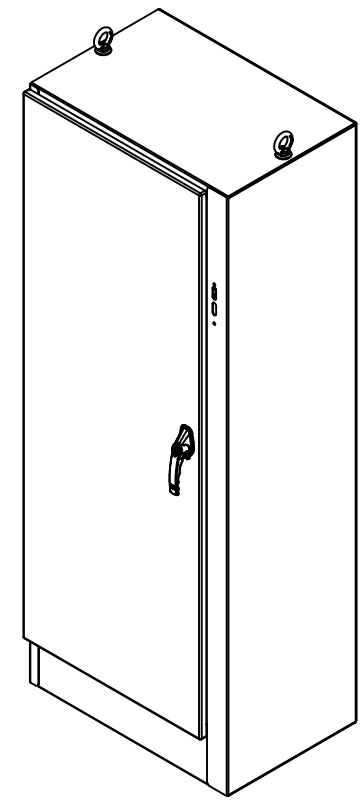

Isometric View



PACKING		
ITEM	QTY	DESCRIPTION
Cardboard sleeve	2	Top and Bottom
Cardboard strip	2	Between back of enclosure and inner panel
Plastic bag	1	To protect cover surface and inside gasket
Cardboard corner	4	To reinforced for the plastic strap tightening
Plastic strap - Black	2	To Squeeze 2 cardboard sleeve together
Packaging label	3	White label with PN
Plastic strap- Green	2	To secure the enclosure to the wood pallet
Wood Pallet	1	2" deeper and 3" larger than enclosure size

Qty	Part Number	Rev	Description
1	9500U1D722818GP	0	9500U1D Gland Plate
1	880EB14	2	Eye Bolt M14 (Pack of 2)
6	STK-Q-07320	0	Flange Lock Nut M10
1	9500U1D722818IP	0	9500U1D 72" x 27.5" Inner Panel
6	STK-Q-07620	0	M10 Plastic Spacer 0.875"
1	9500U1D722818C	0	9500U1D 72" x 27.5" Back Cover
1	9500U1D722818B	0	9500U1D 72" x 27.5" x 18" Body
4	STK-Q-04050-10	8	M6 x 10mm Hexagon Socket Head Machine Screw with Nyseal
Parts List			

		Tél: (450) 979-4373 Fax: (450) 979-4626 www.exmweb.com		Flatness Aplatissement Max 3.0mm Projection 	
Customer Client		Date		Date 04-Nov-14	
Drawn By Dessiné Par		BoxCad: BoxCad		Date	
Material Matière		12 Ga Cold Rolled A1008 CS Type B (2.5mm)			
Color Couleur		Asa-61 Grey		Finish Fini Smooth	
Description				Detail Rev.	
9500U1D 72" x 27.5" x 18" Assembly					
Part Number Numéro Pièce				Rev.	
9500U1D722818				0	
				2	

This drawing is confidential and must not be reproduced or used without the consent of EXM

Ce dessin est confidentiel et ne doit pas être reproduit ou utilisé sans le consentement de EXM

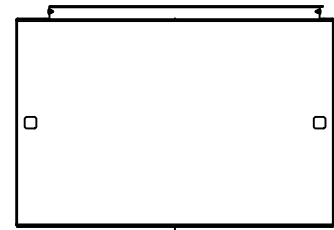

TOP

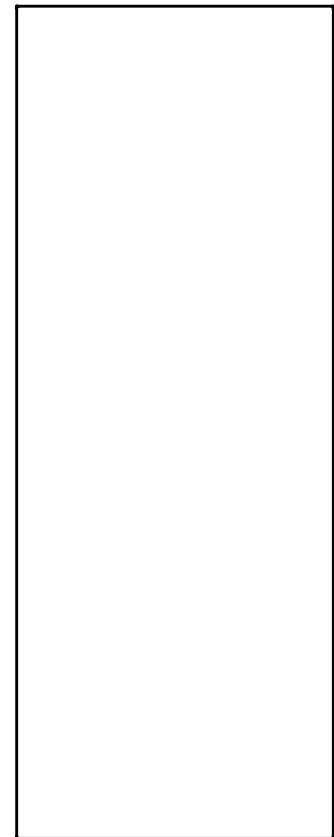

BACK

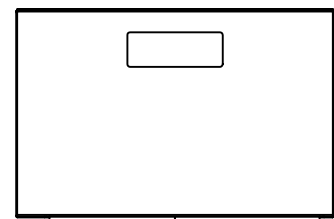

BOTTOM

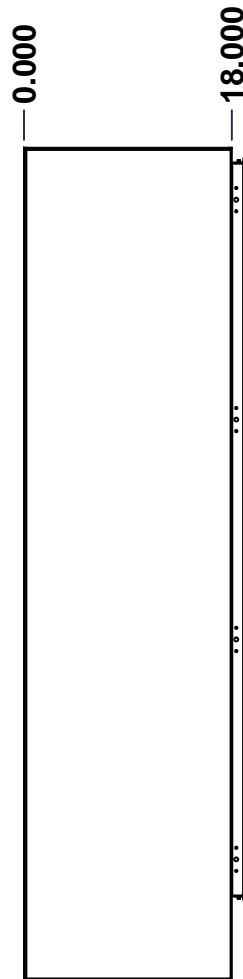

LEFT

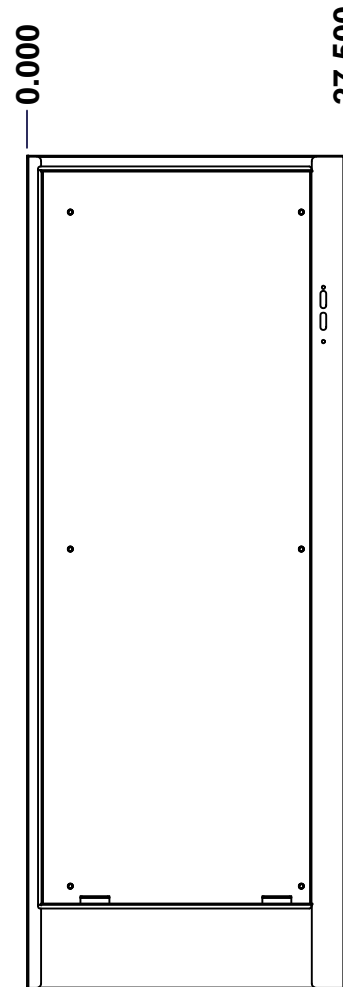

FRONT

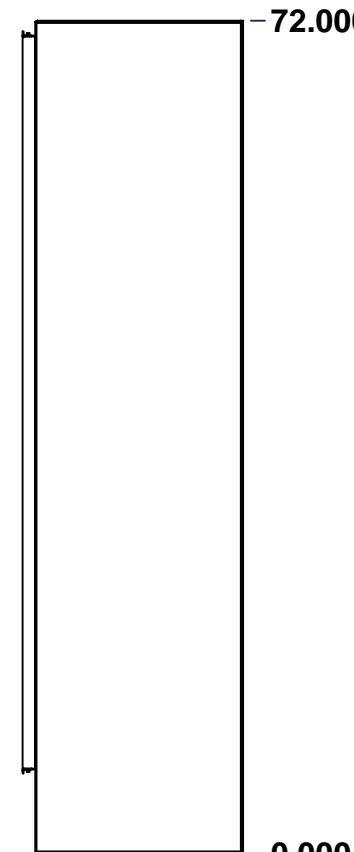

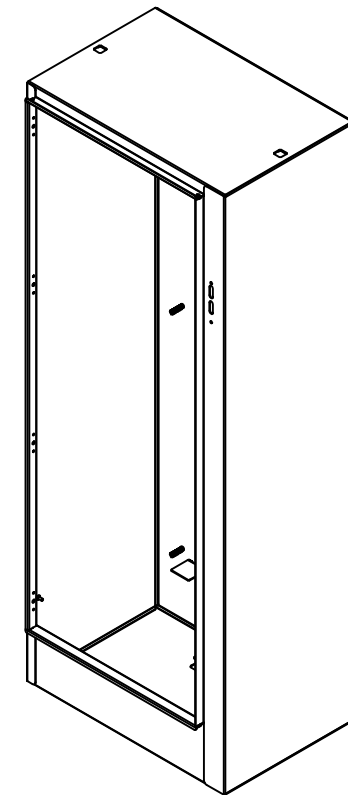

RIGHT



Isometric View

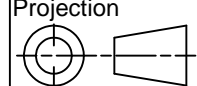

No.	Revisions	Date	By/Par

 Tél: (450) 979-4373 Fax: (450) 979-4626 www.exmweb.com		Flatness Aplatissement  Max 3.0mm Projection 
Customer Client	Date	
Drawn By Dessiné Par	BoxCad: BoxCad	Date 04-Nov-14
Material Matière	12 Ga Cold Rolled A1008 CS Type B (2.5mm)	
Color Couleur	Asa-61 Grey	Finish Fini Smooth
Description	9500U1D 72" x 27.5" x 18" Body	
Part Number Numéro Pièce	9500U1D722818B	Detail Rev. Rev. 1 0 2

SEE BILL OF MATERIAL ON LAST PAGE

This drawing is confidential and must not be reproduced or used without the consent of EXM

Ce dessin est confidentiel et ne doit pas être reproduit ou utilisé sans le consentement de EXM

STANDARD FEATURES ARE NOT LISTED IN THIS HOLE TABLE

HOLE TABLE - TOP VIEW (CUSTOM FEATURE ONLY)

CUT-OUT	XDIM	YDIM	DESCRIPTION
1	13.661	13.911	Struts CR400 21.500" (Inside)
2	13.661	13.911	STUDS M6 x 10mm (Inside)
3	5.911	13.911	STUDS M6 x 10mm (Inside)
4	21.411	13.911	STUDS M6 x 10mm (Inside)

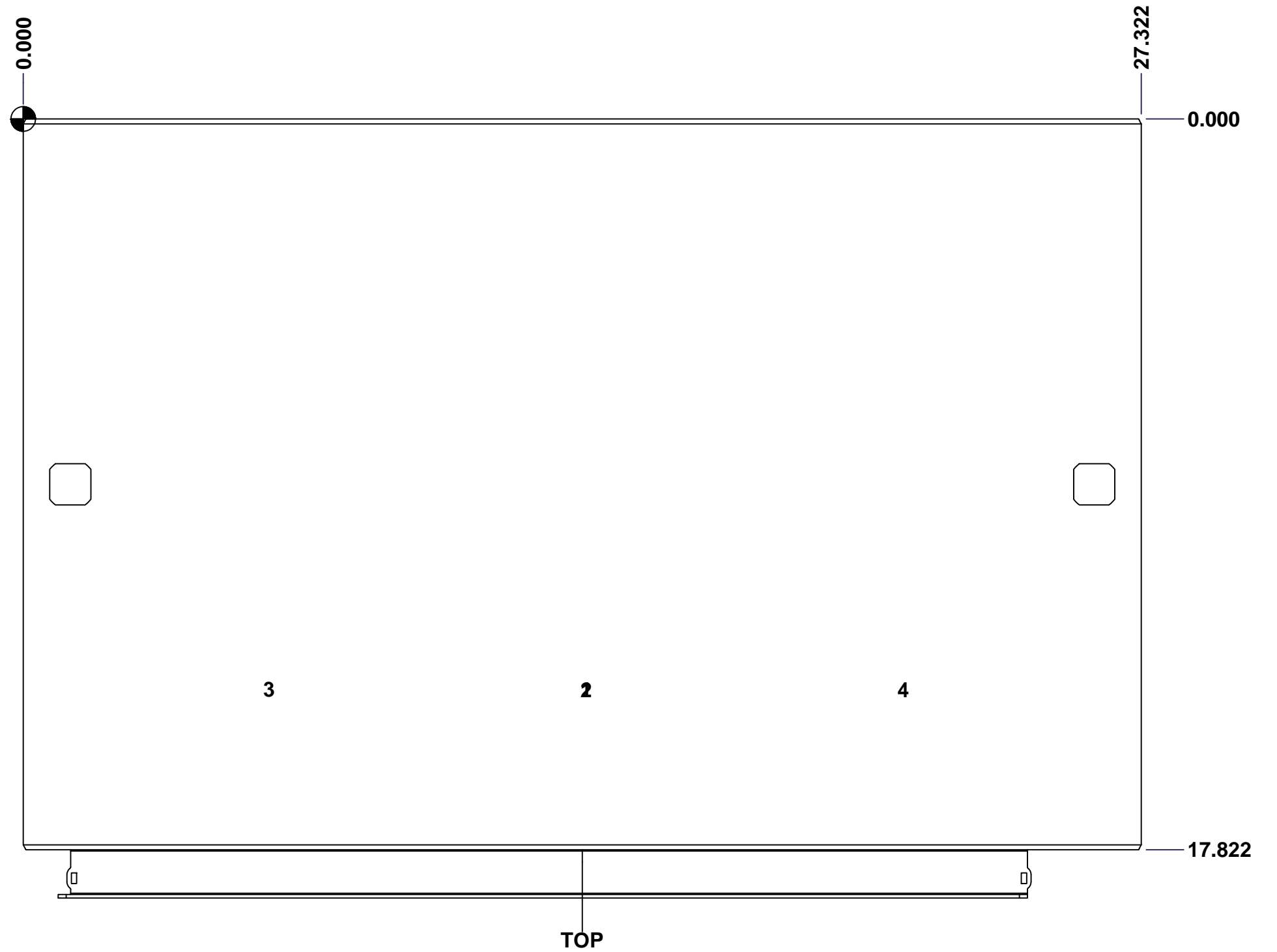

	Description	Status
	9500U1D 72" x 27.5" x 18" Body	Released
	Part Number Numéro Pièce	Rev.
	9500U1D722818B	0
		2 / 7

This drawing is confidential and must not be reproduced or used without the consent of EXM

Ce dessin est confidentiel et ne doit pas être reproduit ou utilisé sans le consentement de EXM

STANDARD FEATURES ARE NOT LISTED IN THIS HOLE TABLE			
HOLE TABLE - BOTTOM VIEW (CUSTOM FEATURE ONLY)			
CUT-OUT	XDIM	YDIM	DESCRIPTION
1	9.036	3.411	GP STUD M6 x 16mm (Inside)
2	18.286	3.411	GP STUD M6 x 16mm (Inside)

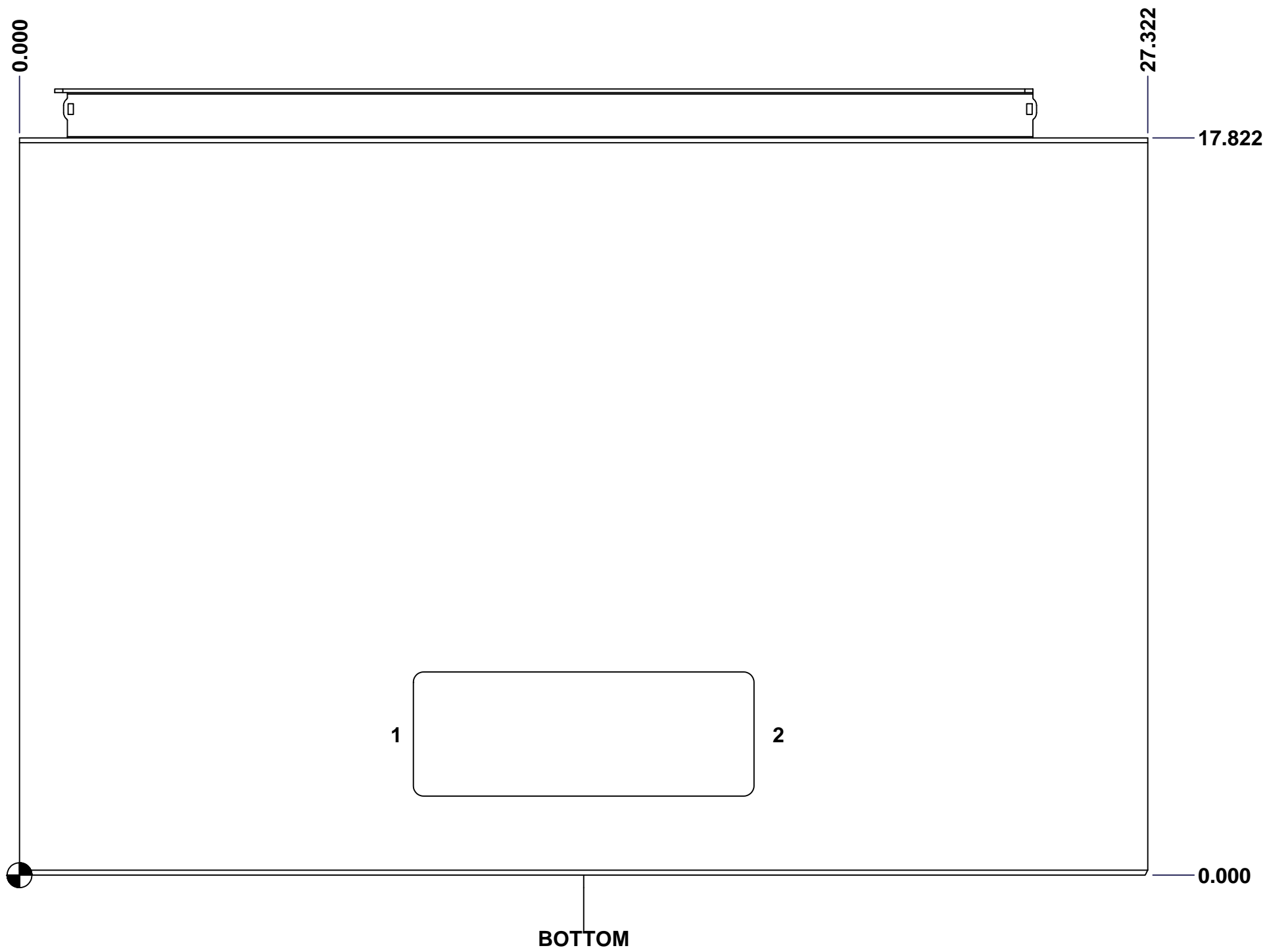

	Description		Status	
	9500U1D 72" x 27.5" x 18" Body		Released	
Part Number Numéro Pièce		Rev.	4 / 7	
9500U1D722818B		0		

This drawing is confidential and must not be reproduced or used without the consent of EXM

Ce dessin est confidentiel et ne doit pas être reproduit ou utilisé sans le consentement de EXM

STANDARD FEATURES ARE NOT LISTED IN THIS HOLE TABLE			
HOLE TABLE - LEFT VIEW (CUSTOM FEATURE ONLY)			
CUT-OUT	XDIM	YDIM	DESCRIPTION
1	16.411	9.286	GND STUD M6 x 16mm (Inside)

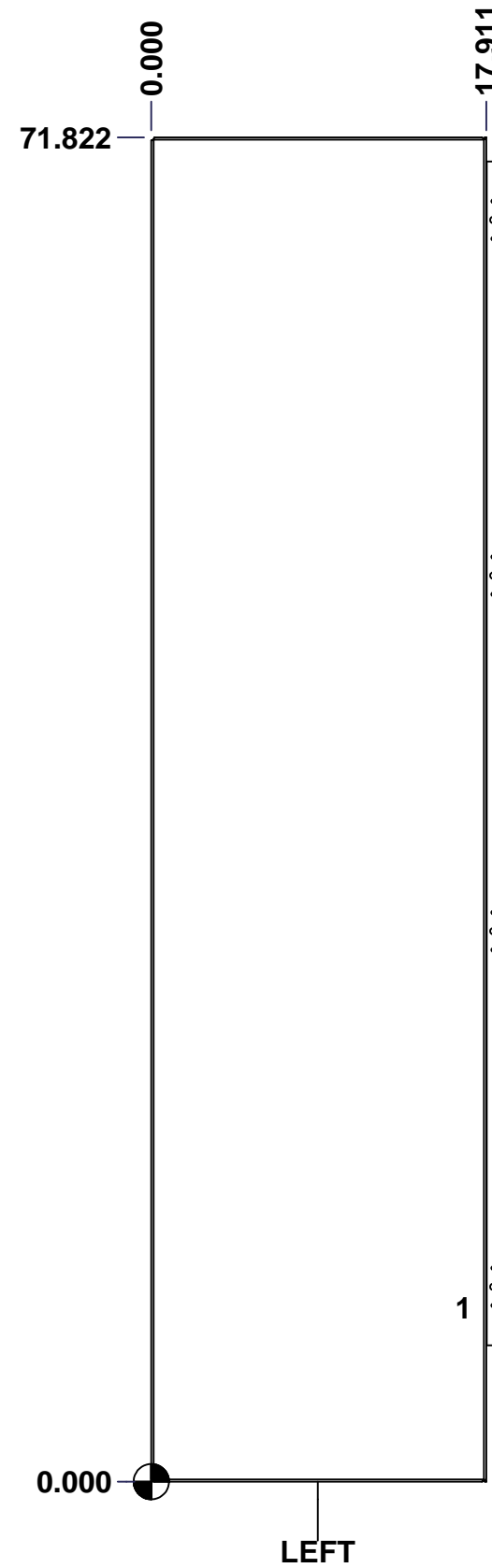

	Description		Status	
	9500U1D 72" x 27.5" x 18" Body		Released	
Part Number Numéro Pièce		Rev.	5	7
9500U1D722818B		0		

This drawing is confidential and must not be reproduced or used without the consent of EXM

Ce dessin est confidentiel et ne doit pas être reproduit ou utilisé sans le consentement de EXM

STANDARD FEATURES ARE NOT LISTED IN THIS HOLE TABLE

HOLE TABLE - BACK VIEW (CUSTOM FEATURE ONLY)

CUT-OUT	XDIM	YDIM	DESCRIPTION
1	3.661	8.786	IP STUD M10 x 40mm (Inside)
2	23.661	8.786	IP STUD M10 x 40mm (Inside)
3	3.661	37.911	IP STUD M10 x 40mm (Inside)
4	23.661	37.911	IP STUD M10 x 40mm (Inside)
5	3.661	67.036	IP STUD M10 x 40mm (Inside)
6	23.661	67.036	IP STUD M10 x 40mm (Inside)
-----	-----	-----	-----
7	21.536	7.411	IP SUPPORT ANGLE (Inside)
8	5.786	7.411	IP SUPPORT ANGLE (Inside)

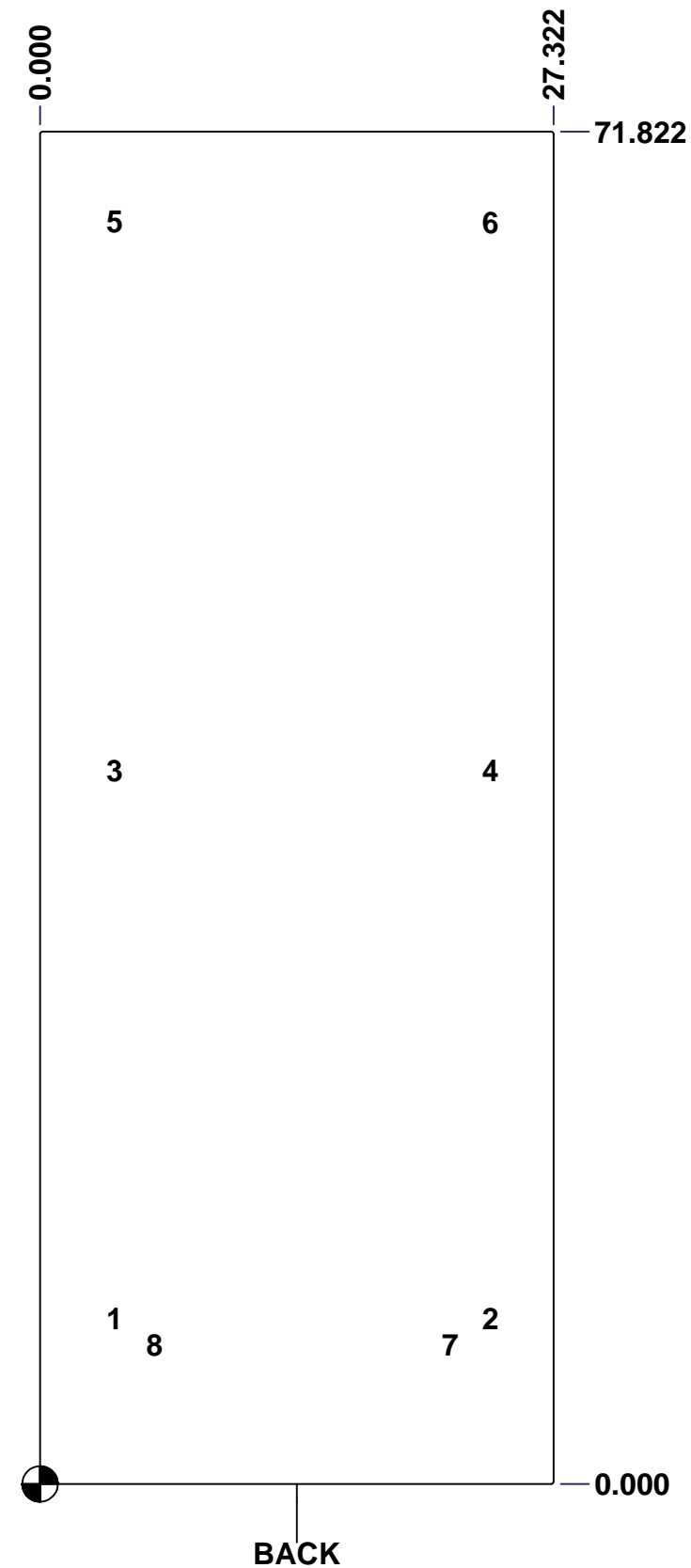

	Description	Status
	9500U1D 72" x 27.5" x 18" Body	Released
	Part Number Numéro Pièce	Rev.
	9500U1D722818B	0
		6
		7

This drawing is confidential and must not be reproduced or used without the consent of EXM

Ce dessin est confidentiel et ne doit pas être reproduit ou utilisé sans le consentement de EXM

No.	Revisions	Date	By/Par

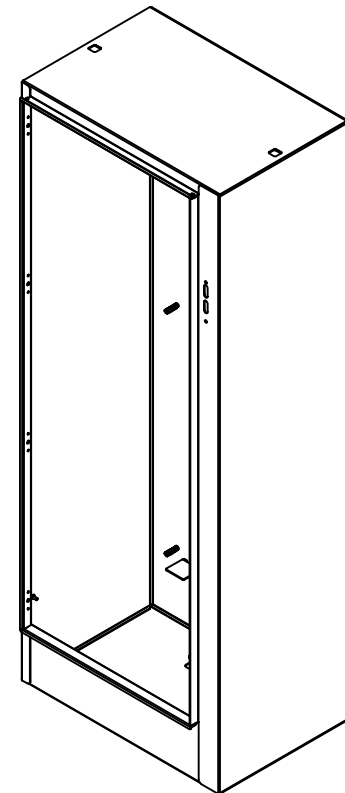

Isometric View

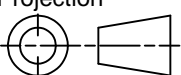

Qty	Part Number	Rev	Description
3	STK-Q-16030	0	Stud M6 x 10mm
2	9500U1D722818BPA-P	0	9500U1D Inner Panel Support Angle
3	STK-Q-07220	1	M6 Nylon Insert Lock Nut
1	CR400MS_21.5	0	Commercial Roll Mild Steel (21.5in long)
1	STK-P-02400S	0	Powder Paint (Asa-61 Grey / Smooth)
6	STK-Q-16100	0	Stud M10 x 40mm
1	9500U1D722818BT-P	0	9500U1D 27.5" x 18" Bottom Part
1	9500U1D722818T-P	0	9500U1D 27.5" x 18" Top Part
1	9500U1D722818RS-P	0	9500U1D 72" x 27.5" Right Part
1	9500U1D722818LS-P	0	9500U1D 72" x 27.5" Left Part
1	9500U1D722818B-P	0	9500U1D 72" x 27.5" Back Part
3	STK-Q-16080	0	Ground Stud M6 x 16mm
Parts List			

 Tél: (450) 979-4373 Fax: (450) 979-4626 www.exmweb.com		Flatness Aplatissement Max 3.0mm Projection 
Customer Client	Date	
Drawn By Dessiné Par	BoxCad: BoxCad	Date 04-Nov-14
Material Matière	12 Ga Cold Rolled A1008 CS Type B (2.5mm)	
Color Couleur	Asa-61 Grey	Finish Fini Smooth
Description	9500U1D 72" x 27.5" x 18" Body	
Part Number Numéro Pièce	Rev. 0	2
9500U1D722818B		2

This drawing is confidential and must not be reproduced or used without the consent of EXM

Ce dessin est confidentiel et ne doit pas être reproduit ou utilisé sans le consentement de EXM

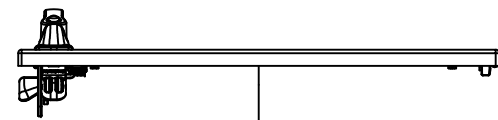

TOP

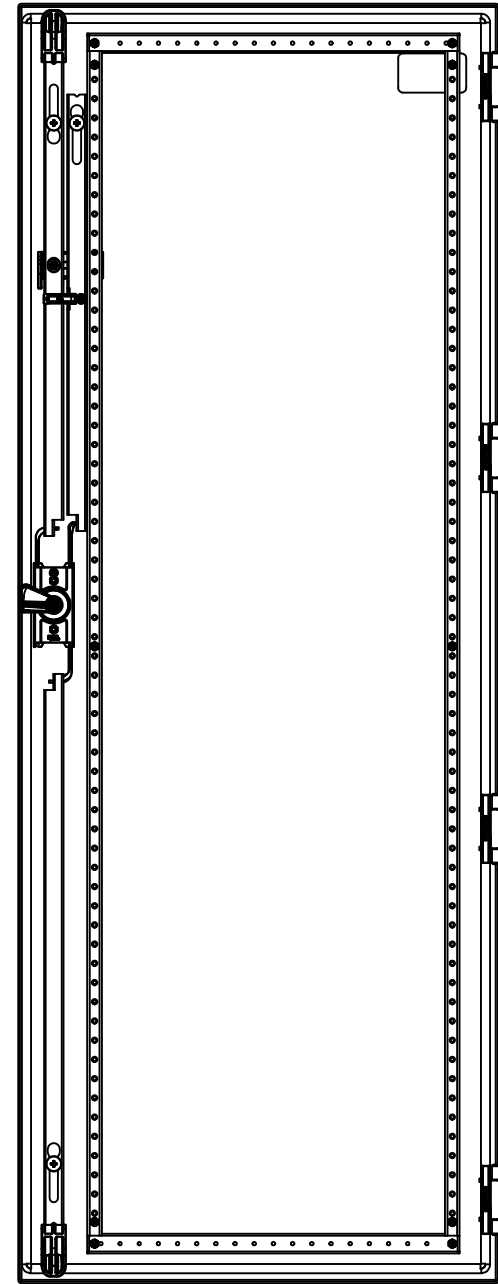

BACK



BOTTOM

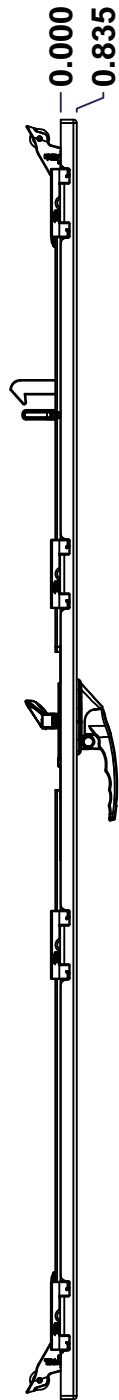

LEFT

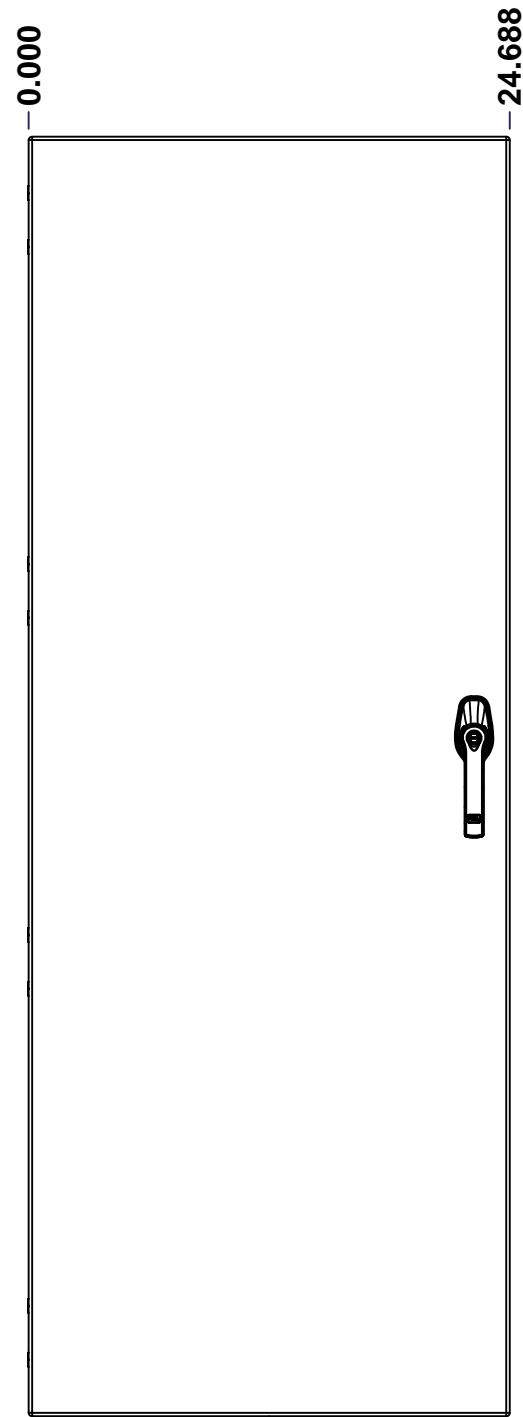

FRONT

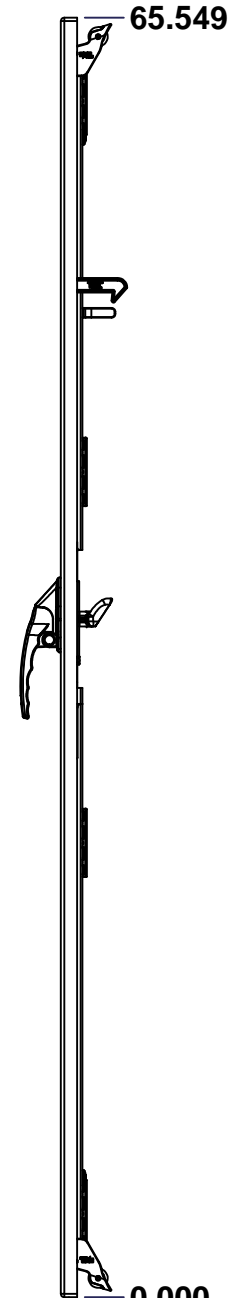

RIGHT

No.	Revisions	Date	By/Par

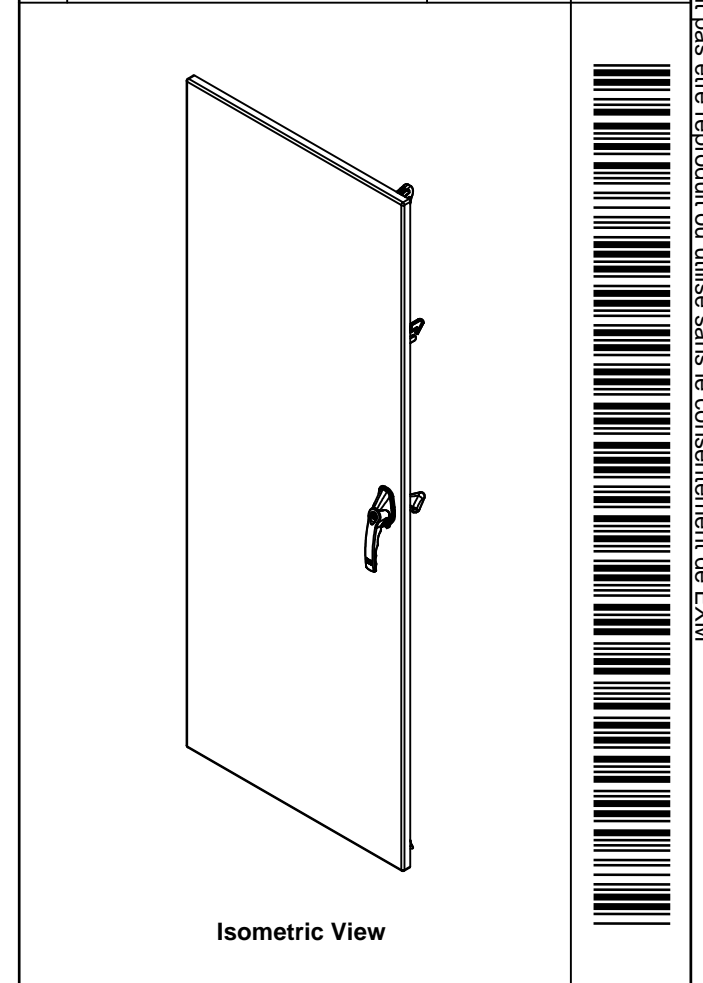

Isometric View

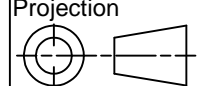
 Tél: (450) 979-4373 Fax: (450) 979-4626 www.exmweb.com		Flatness Aplatissement Max 3.0mm Projection 
Customer Client	Date	Date
Drawn By Dessiné Par	BoxCad: BoxCad	04-Nov-14
Material Matière 12 Ga Cold Rolled A1008 CS Type B (2.5mm)		
Color Couleur	Asa-61 Grey	Finish Fini Smooth
Description 9500U1D 72" x 27.5" Back Cover		Detail Rev.
Part Number Numéro Pièce	9500U1D722818C	Rev. 1 0 3

SEE BILL OF MATERIAL ON LAST PAGE

This drawing is confidential and must not be reproduced or used without the consent of EXM

Ce dessin est confidentiel et ne doit pas être reproduit ou utilisé sans le consentement de EXM

STANDARD FEATURES ARE NOT LISTED IN THIS HOLE TABLE			
HOLE TABLE - FRONT VIEW (CUSTOM FEATURE ONLY)			
CUT-OUT	XDIM	YDIM	DESCRIPTION
1	2.406	2.028	STUD M6 x 18mm (Inside)
2	2.406	32.628	STUD M6 x 18mm (Inside)
3	2.406	63.521	STUD M6 x 18mm (Inside)
4	20.762	2.028	STUD M6 x 18mm (Inside)
5	20.762	32.628	STUD M6 x 18mm (Inside)
6	20.762	63.521	STUD M6 x 18mm (Inside)
7	2.406	3.139	STUD M6 x 18mm (Inside)
8	2.406	62.409	STUD M6 x 18mm (Inside)
9	20.762	3.139	STUD M6 x 18mm (Inside)
10	20.762	62.409	STUD M6 x 18mm (Inside)
11	22.859	6.118	STUD M6 x 18mm (Inside)
12	22.859	59.430	STUD M6 x 18mm (Inside)
13	21.672	59.430	STUD M6 x 18mm (Inside)
14	22.859	52.149	STUD M6 x 18mm (Inside)
15	21.672	52.149	STUD M6 x 18mm (Inside)

16	22.859	34.743	HANDLE 885 ESL2A-APHD @ 0.0°

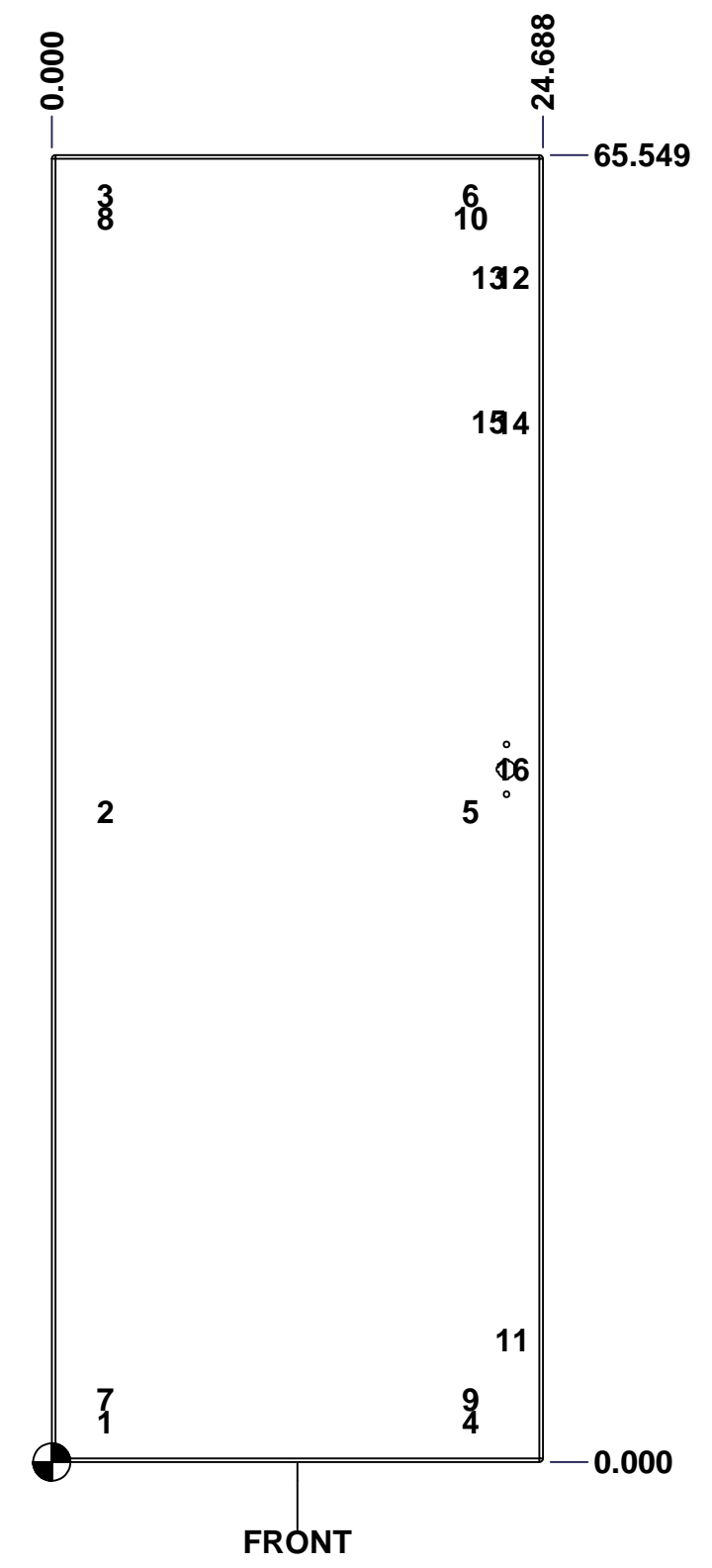

	Description	Status
	9500U1D 72" x 27.5" Cover	(NULL)
	Part Number Numéro Pièce	Rev.
	9500U1D722818C	0
		2
		3

This drawing is confidential and must not be reproduced or used without the consent of EXM

Ce dessin est confidentiel et ne doit pas être reproduit ou utilisé sans le consentement de EXM

No.	Revisions	Date	By/Par

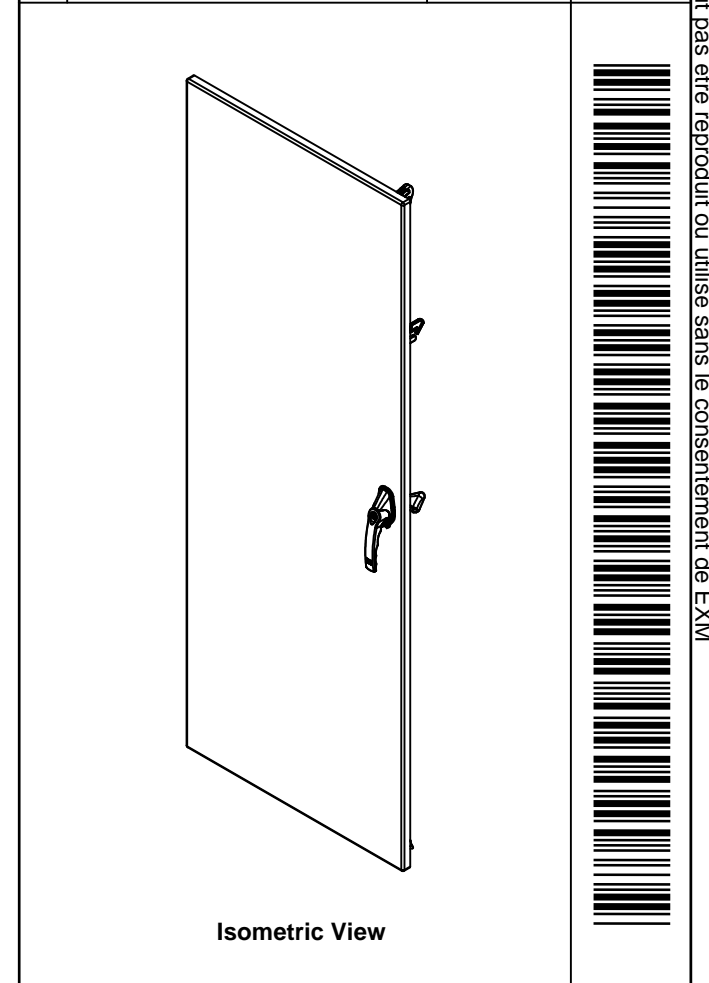

1	9500U1D722818DB_ESY	0	9500U1D 72" Disconnect Defeater Bar
1	9500U1D722818CB	0	9500U1D 72" Closing Bar
1	9500U1D722818CB_ESY	0	9500U1D 72" Disconnect Closing Bar
1	STK-K-03895-36	3	Gearbox Clockwise Assembly (Grip 36mm)
1	885ESL2A-APHD	0	885 ESL2A-APHD - Zinc Die Cast L-Handle Padlockable Assy - Slot Cylinder
1	STK-P-02400S	0	Powder Paint (Asa-61 Grey / Smooth)
1	STK-Q-07220	1	M6 Nylon Insert Lock Nut
1	STK-Q-13060	1	M6 Flat Washer
1	STK-Q-46600	3	5500 ESY Disconnect Door Hook
1	9500U1D722818G	0	9500U1D 72" x 27.5" Cover Gasket
1	STK-S-00100	0	3.5" x 2" Silver Milar Flexcon Sticker
1	9500U1D722818DS1	0	9500U1D 72" x 27.5" Door Stiffener
15	STK-Q-16055	1	M6 x 18mm Stud (No Paint Cap Required)
1	9500U1D722818C-P	0	9500U1D 72" x 27.5" Cover Part
4	STK-K-09860	7	Cabinet Hinge with Captive Pins
Qty	Part Name	Rev	Description
Parts List			

Tél: (450) 979-4373 Fax: (450) 979-4626 www.exmweb.com		Flatness Aplatissement
		Max 3.0mm
Customer Client Drawn By / Dessiné Par: BoxCad: BoxCad Material / Matière: 12 Ga Cold Rolled A1008 CS Type B (2.5mm)		Projection
Date		Date
Date		04-Nov-14
Color / Couleur: Asa-61 Grey		Finish / Fini: Smooth
Description: 9500U1D 72" x 27.5" Back Cover		Detail Rev.
Part Number / Numéro Pièce: 9500U1D722818C		Rev. 3
		0 / 3

This drawing is confidential and must not be reproduced or used without the consent of EXM

Ce dessin est confidentiel et ne doit pas être reproduit ou utilisé sans le consentement de EXM

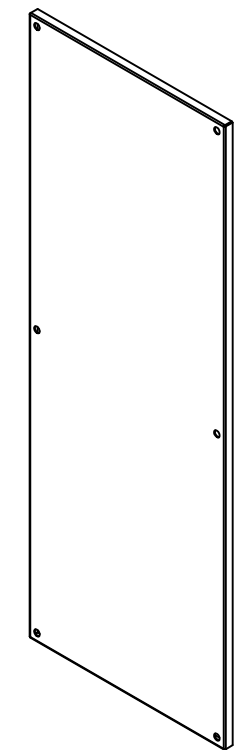
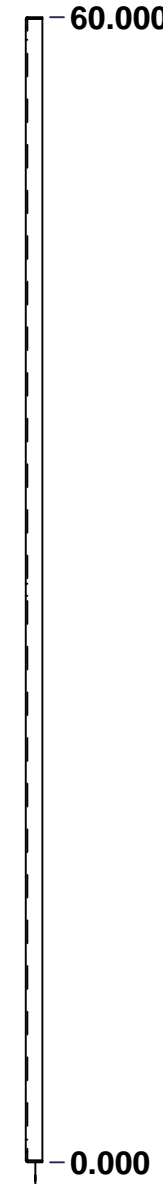
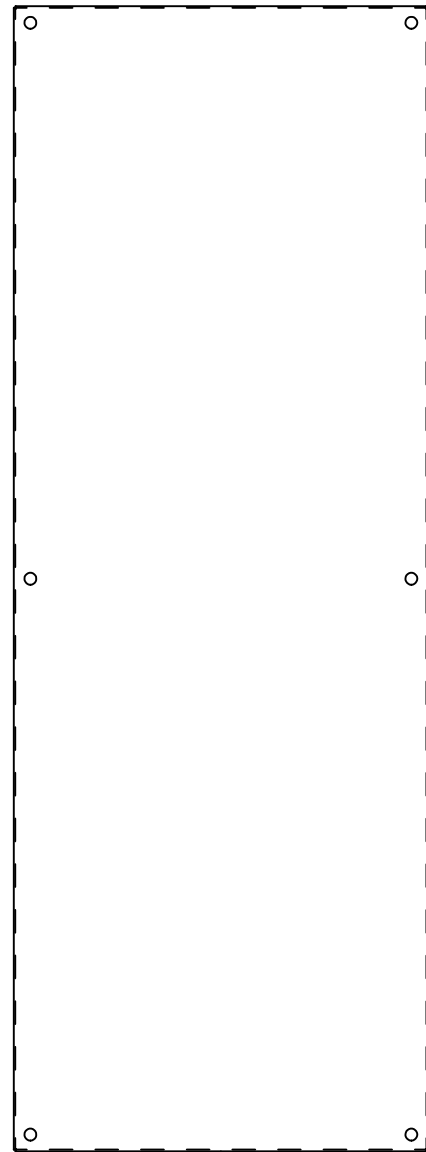
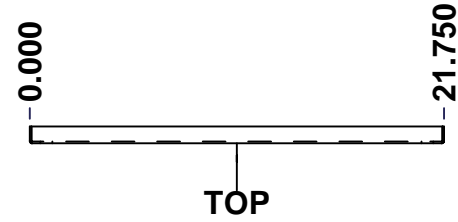

No.	Revisions	Date	By/Par

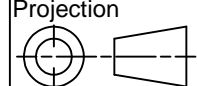
 Tél: (450) 979-4373 Fax: (450) 979-4626 www.exmweb.com		Flatness Aplatissement Max 3.0mm Projection 
Customer Client	Date	Date
Drawn By Dessiné Par	BoxCad: BoxCad	Date 04-Nov-14
Material Matière 12 Ga Galvanized (2.5mm)		
Color Couleur	Unpainted	Finish Fini Unpainted
Description 9500U1D 72" x 27.5" Inner Panel		Detail Rev.
Part Number Numéro Pièce		Rev.
9500U1D722818IP		0 1 / 3

SEE BILL OF MATERIAL ON LAST PAGE

This drawing is confidential and must not be reproduced or used without the consent of EXM

Ce dessin est confidentiel et ne doit pas être reproduit ou utilisé sans le consentement de EXM

No.	Revisions	Date	By/Par

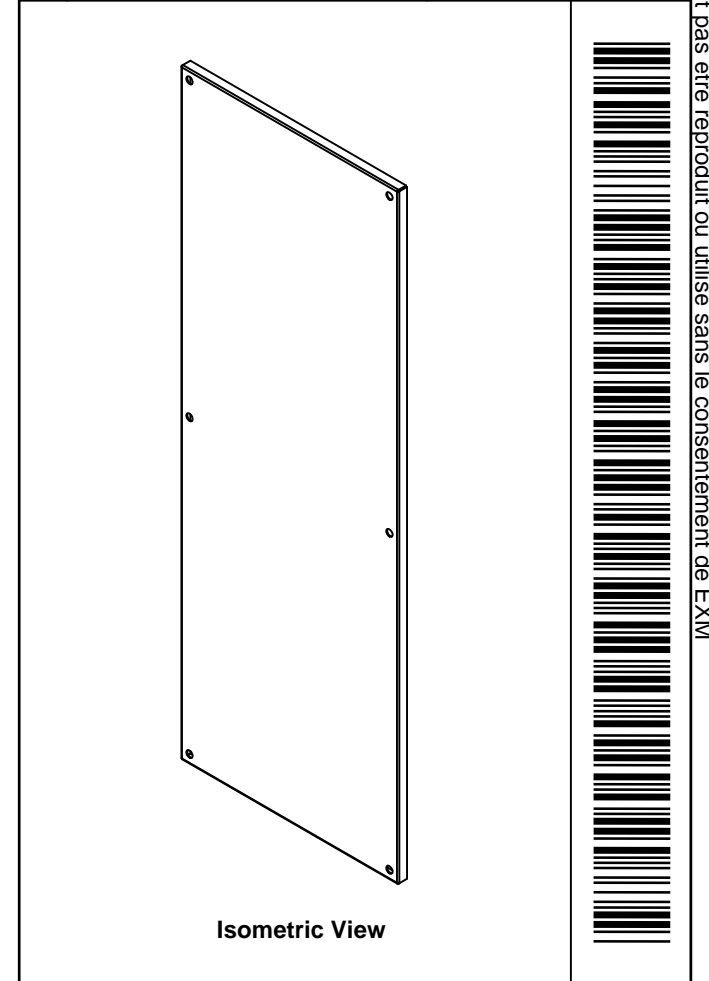

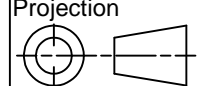
 Tél: (450) 979-4373 Fax: (450) 979-4626 www.exmweb.com		Flatness Aplatissement Max 3.0mm Projection 
Customer Client	Date	
Drawn By Dessiné Par	BoxCad: BoxCad	Date 04-Nov-14
Material Matière 12 Ga Galvanized (2.5mm)		
Color Couleur	Unpainted	Finish Fini Unpainted
Description 9500U1D 72" x 27.5" Inner Panel		Detail Rev.
Part Number Numéro Pièce	9500U1D722818IP	Rev. 3 0 3

Qty	Part Number	Rev	Description
1	9500U1D722818IP-P	0	9500U1D 72" x 27.5" Inner Panel Part
Parts List			