

This drawing is confidential and must not be reproduced or used without the consent of EXM

Ce dessin est confidentiel et ne doit pas être reproduit ou utilisé sans le consentement de EXM

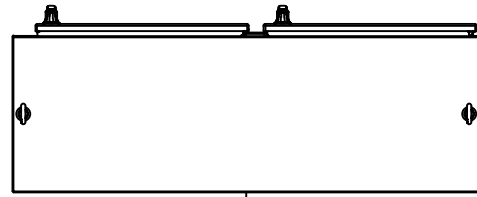

TOP

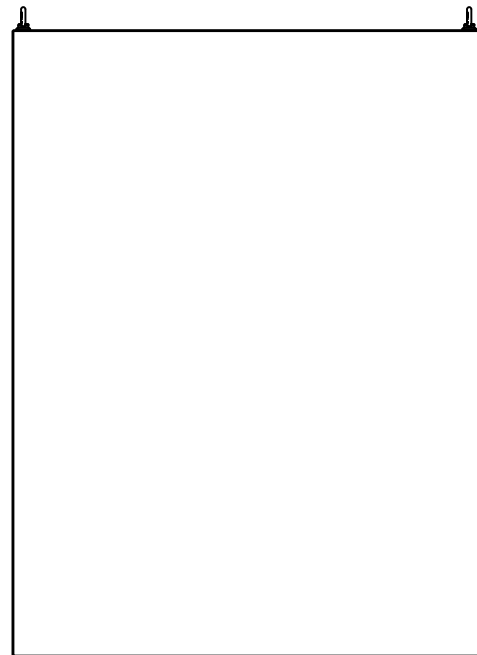

BACK

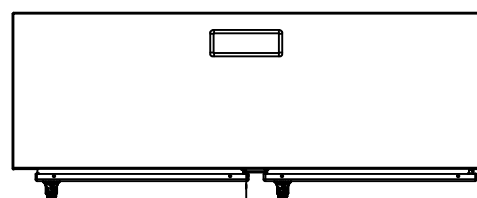

BOTTOM

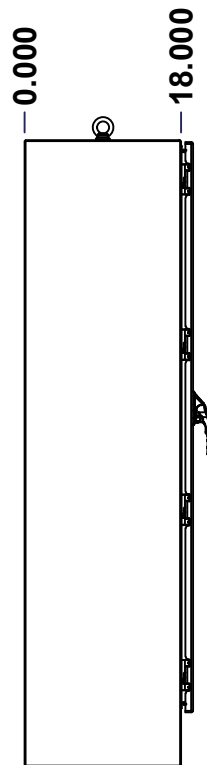

LEFT

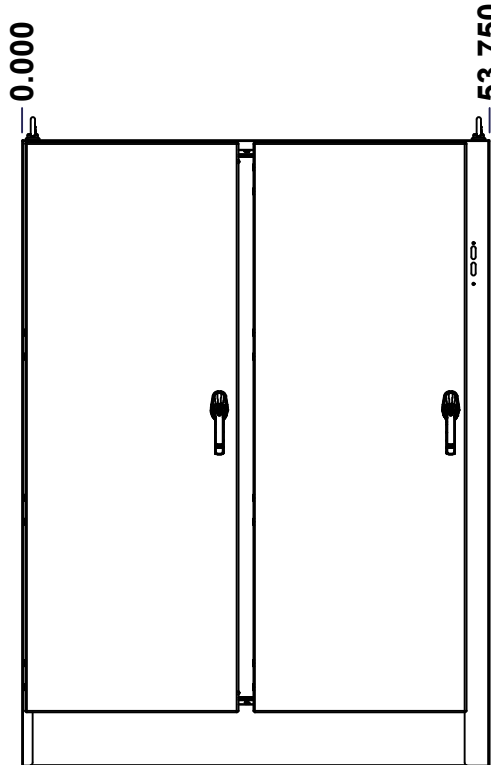

FRONT

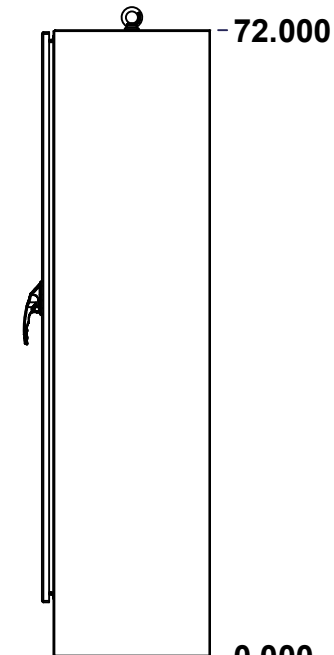

RIGHT

No.	Revisions	Date	By/Par

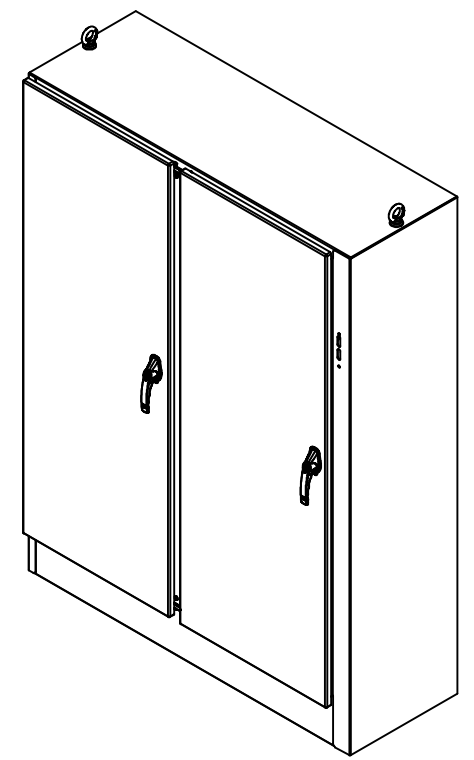

Isometric View



Tél: (450) 979-4373
 Fax: (450) 979-4626
www.exmweb.com

Flatness
Aplatissement
Max 3.0mm
Projection

Customer Client
 Drawn By Dessiné Par BoxCad: BoxCad
 Date 19-Apr-16

Material Matière 12 Ga Cold Rolled A1008 CS Type B (2.5mm)

Color Couleur Asa-61 Grey
 Finish Fini Smooth

Description 9500U2D 72" x 53.75" x 18" Assembly
 Detail Rev.

Part Number Numéro Pièce 9500U2D725418
 Rev. 0

SEE BILL OF MATERIAL ON LAST PAGE

This drawing is confidential and must not be reproduced or used without the consent of EXM

Ce dessin est confidentiel et ne doit pas être reproduit ou utilisé sans le consentement de EXM

NOTE	
ITEM	DESCRIPTION
1	NEMA 12/13 Enclosure
2	C/W Standard ground studs on box and cover
3	C/W Standard door stiffener
4	C/W Special inner panel (Sold separately)
5	C/W Standard inner panel mounting studs
6	C/W Eyebolts
7	C/W Struts installed (Included)

No.	Revisions	Date	By/Par

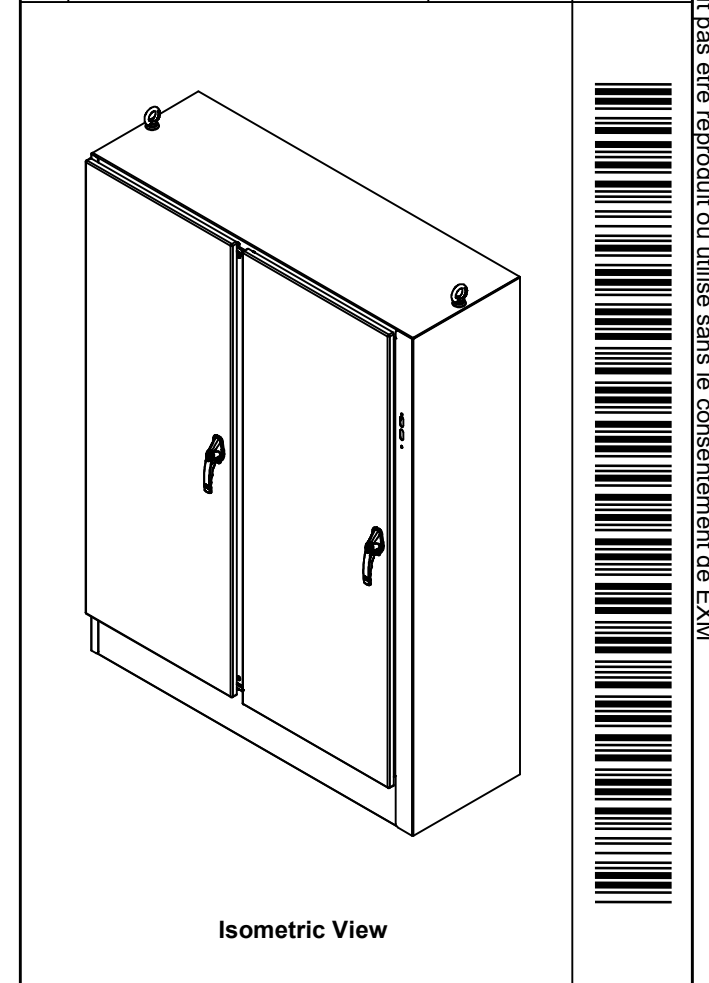

PACKING		
ITEM	QTY	DESCRIPTION
Cardboard sleeve	2	Top and Bottom
Cardboard strip	2	Between back of enclosure and inner panel
Plastic bag	1	To protect cover surface and inside gasket
Cardboard corner	4	To reinforced for the plastic strap tightening
Plastic strap - Black	2	To Squeeze 2 cardboard sleeve together
Packaging label	3	White label with PN
Plastic strap- Green	2	To secure the enclosure to the wood pallet
Wood Pallet	1	2" deeper and 3" larger than enclosure size

1	880INTI	2	880 INTI - Interlock Post Kit
1	9500U2D725418GP	0	9500U2D Gland Plate
1	880EB14	2	Eye Bolt M14 (Pack of 2)
8	STK-Q-07320	0	Flange Lock Nut M10
1	9500U2D725418IP	0	9500U2D 72" x 53.75" Inner Panel
8	STK-Q-07620	0	M10 Plastic Spacer 0.875"
1	9500U2D725418FD	0	9500U2D 72" x 53.75" Lock Door
1	9500U2D725418LD	0	9500U2D 72" x 53.75" Lock Door
1	9500U2D725418B	0	9500U2D 72" x 53.75" x 18" Body
8	STK-Q-04050-10	8	M6 x 10mm Hexagon Socket Head Machine Screw with Nyseal
Qty	Part Number	Rev	Description
Parts List			

		Flatness Aplatissement Max 3.0mm Projection
Tél: (450) 979-4373 Fax: (450) 979-4626 www.exmweb.com		Customer Client Date
Drawn By Dessiné Par BoxCad: BoxCad		Date 19-Apr-16
Material Matière 12 Ga Cold Rolled A1008 CS Type B (2.5mm)		
Color Couleur Asa-61 Grey	Finish Fini Smooth	
Description 9500U2D 72" x 53.75" x 18" Assembly		Detail Rev.
Part Number Numéro Pièce 9500U2D725418		Rev. 0 / 2 17

This drawing is confidential and must not be reproduced or used without the consent of EXM

Ce dessin est confidentiel et ne doit pas être reproduit ou utilisé sans le consentement de EXM

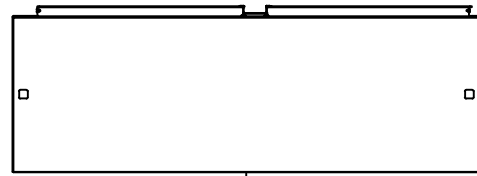

TOP

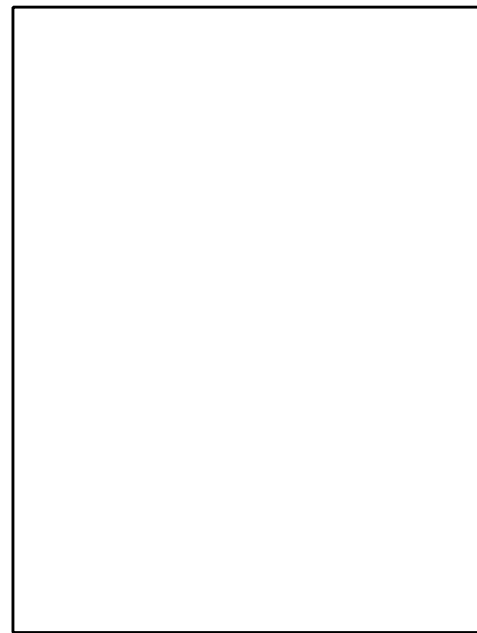

BACK

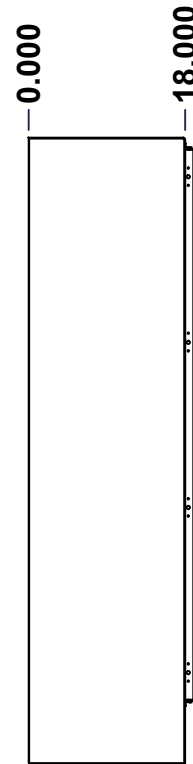

LEFT

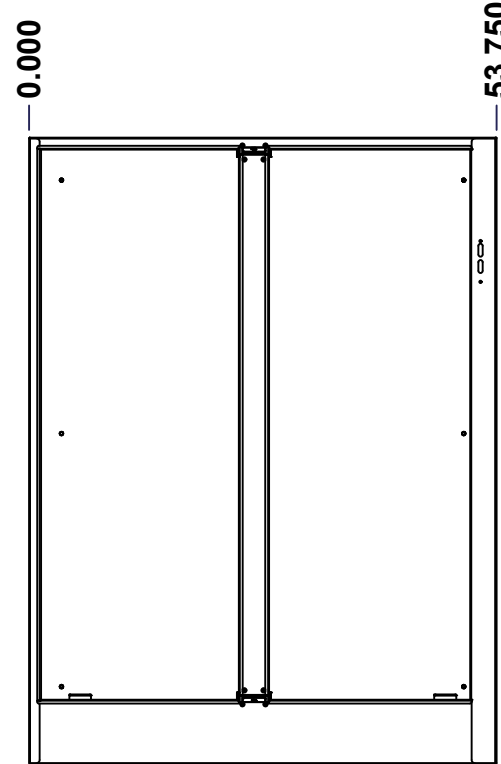

FRONT

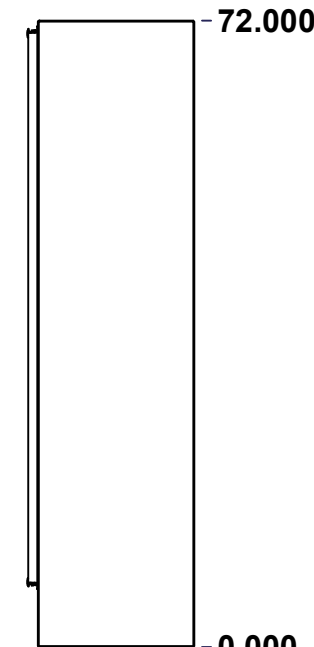

RIGHT

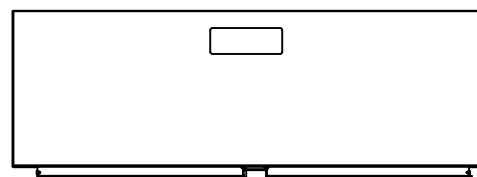

BOTTOM

No.	Revisions	Date	By/Par

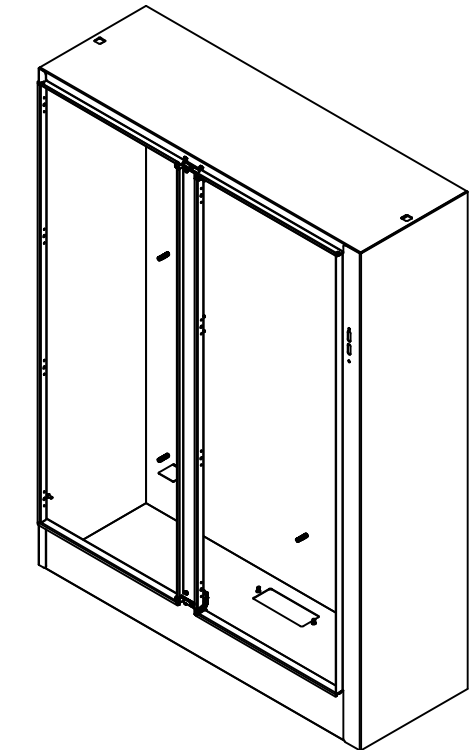

Isometric View



Tél: (450) 979-4373
 Fax: (450) 979-4626
www.exmweb.com

Flatness
Aplatissement

Max 3.0mm

Projection

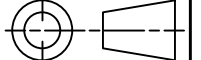

Customer Client	Date
Drawn By / Dessiné Par: BoxCad: BoxCad	Date: 19-Apr-16
Material / Matière: 12 Ga Cold Rolled A1008 CS Type B (2.5mm)	
Color / Couleur: Asa-61 Grey	Finish / Fini: Smooth

Description: 9500U2D 72" x 53.75" x 18" Body	Detail Rev.
--	-------------

Part Number / Numéro Pièce: 9500U2D725418B	Rev. 0	3
---	--------	---

SEE BILL OF MATERIAL ON LAST PAGE

This drawing is confidential and must not be reproduced or used without the consent of EXM

Ce dessin est confidentiel et ne doit pas être reproduit ou utilisé sans le consentement de EXM

STANDARD FEATURES ARE NOT LISTED IN THIS HOLE TABLE

HOLE TABLE - TOP VIEW (CUSTOM FEATURE ONLY)

CUT-OUT	XDIM	YDIM	DESCRIPTION
1	40.224	13.911	Struts CR400 21.500" (Inside)
2	13.349	13.911	Struts CR400 21.500" (Inside)
3	40.224	13.911	STUDS M6 x 10mm (Inside)
4	32.474	13.911	STUDS M6 x 10mm (Inside)
5	47.974	13.911	STUDS M6 x 10mm (Inside)
6	13.349	13.911	STUDS M6 x 10mm (Inside)
7	5.599	13.911	STUDS M6 x 10mm (Inside)
8	21.099	13.911	STUDS M6 x 10mm (Inside)

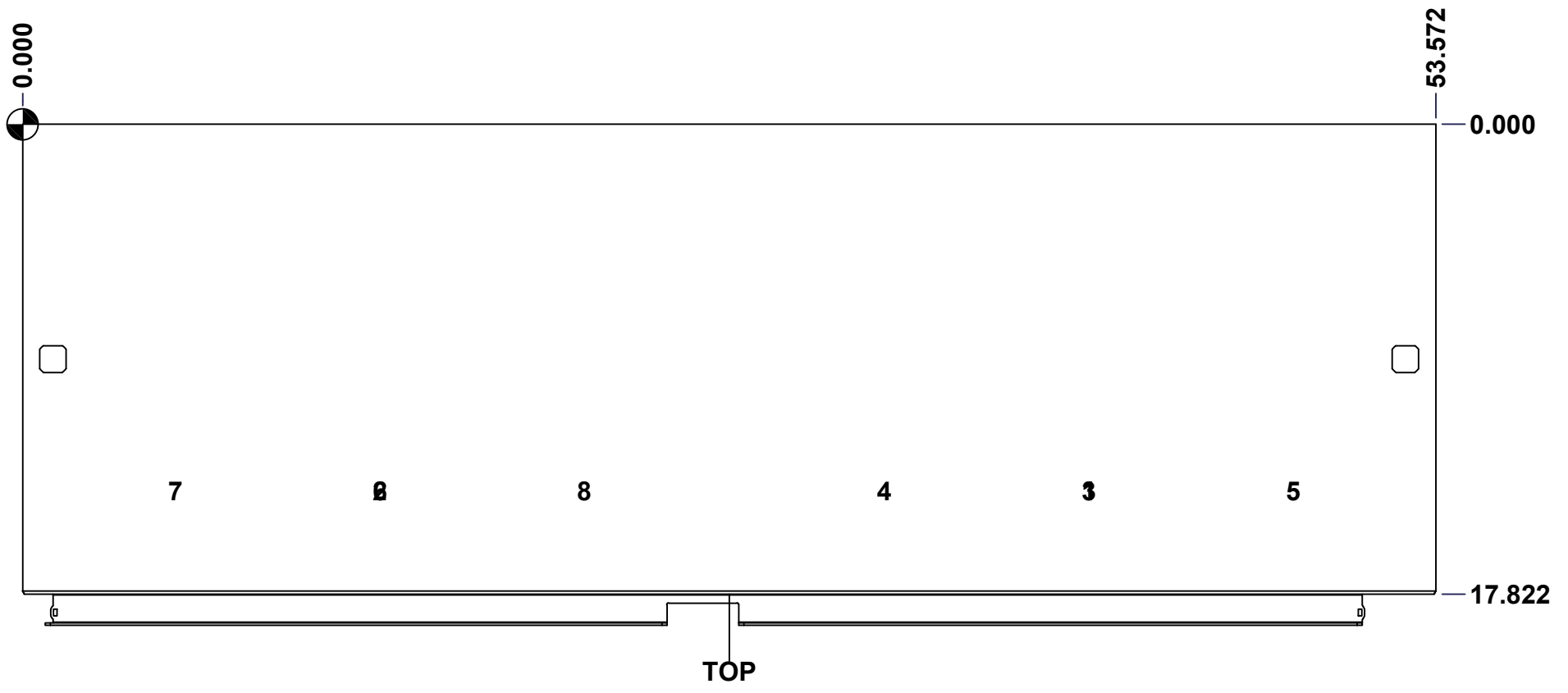

	Description	Status
	9500U2D 72" x 53.75" x 18" Body	(NULL)
Part Number Numéro Pièce 9500U2D725418B	Rev.	4
	0	17

This drawing is confidential and must not be reproduced or used without the consent of EXM

Ce dessin est confidentiel et ne doit pas être reproduit ou utilisé sans le consentement de EXM

STANDARD FEATURES ARE NOT LISTED IN THIS HOLE TABLE			
HOLE TABLE - BOTTOM VIEW (CUSTOM FEATURE ONLY)			
CUT-OUT	XDIM	YDIM	DESCRIPTION
1	22.161	3.411	GP STUD M6 x 16mm (Inside)
2	31.411	3.411	GP STUD M6 x 16mm (Inside)

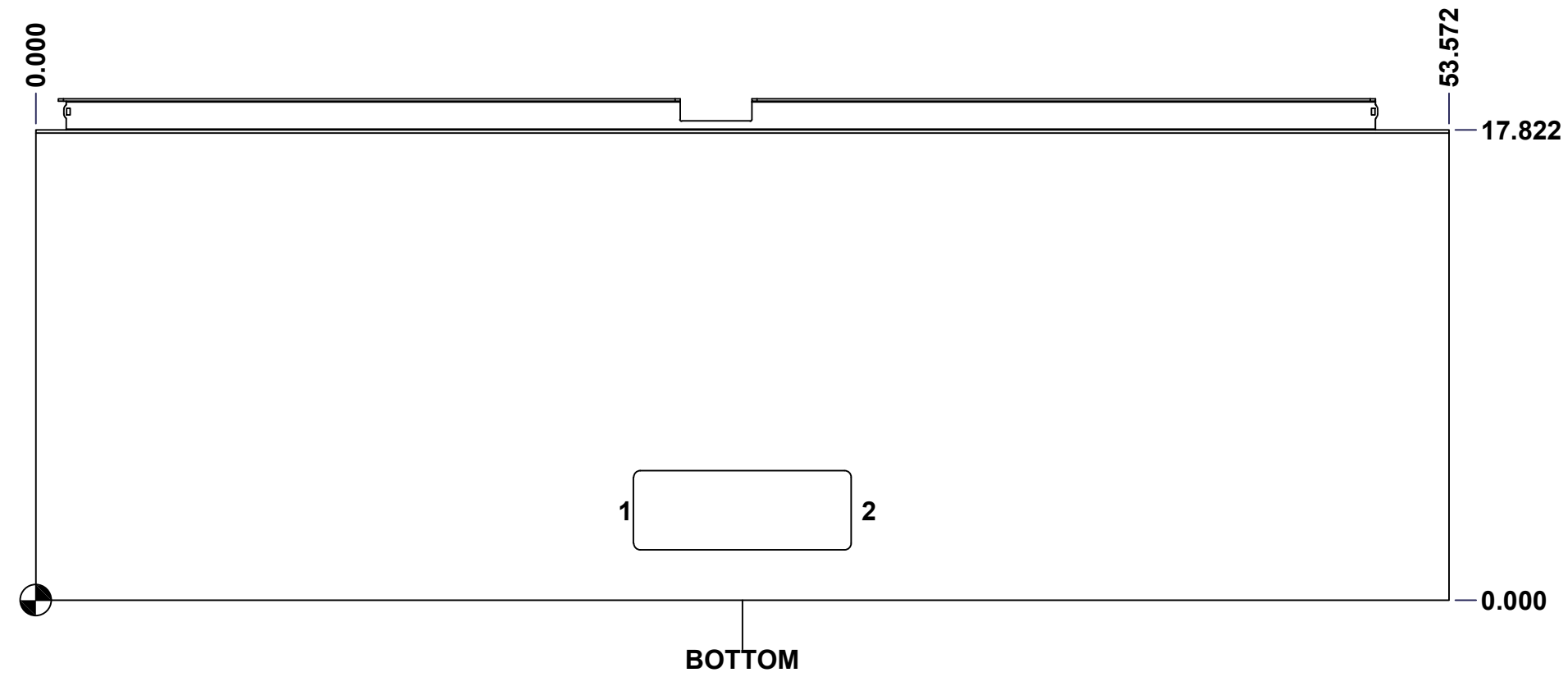

	Description	Status
	9500U2D 72" x 53.75" x 18" Body	(NULL)
	Part Number Numéro Pièce	Rev.
	9500U2D725418B	0
		5
		17

This drawing is confidential and must not be reproduced or used without the consent of EXM

Ce dessin est confidentiel et ne doit pas être reproduit ou utilisé sans le consentement de EXM

STANDARD FEATURES ARE NOT LISTED IN THIS HOLE TABLE			
HOLE TABLE - LEFT VIEW (CUSTOM FEATURE ONLY)			
CUT-OUT	XDIM	YDIM	DESCRIPTION
1	16.411	9.286	GND STUD M6 x 16mm (Inside)

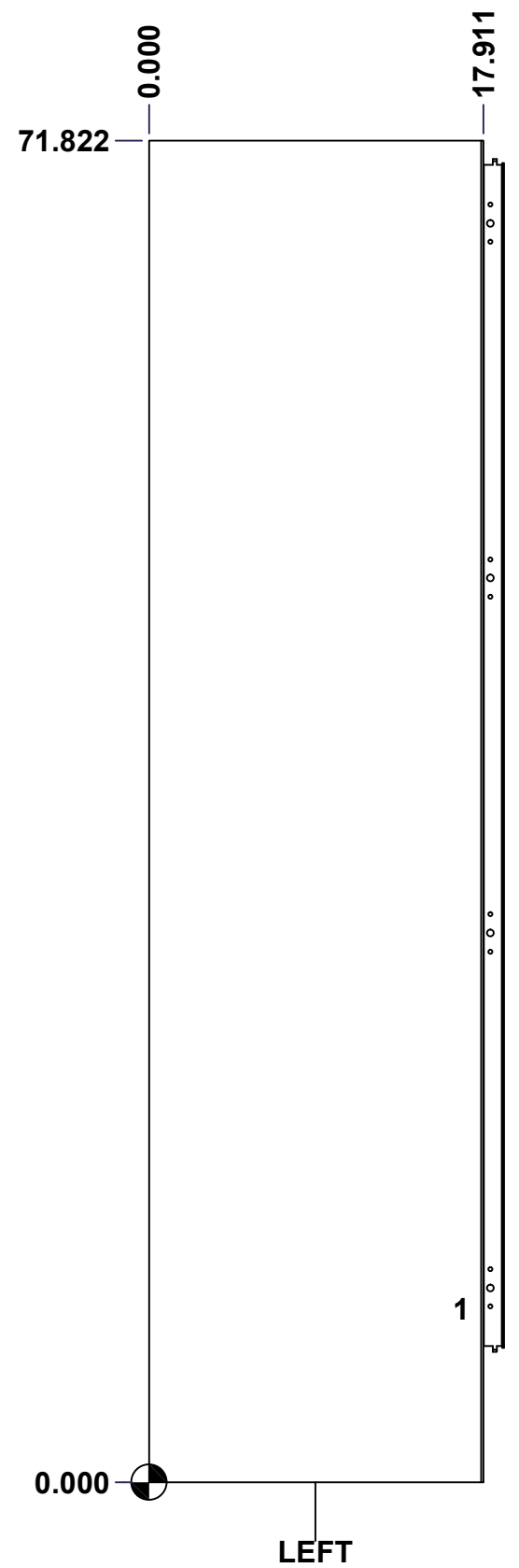

	Description	Status	
	9500U2D 72" x 53.75" x 18" Body	(NULL)	
	Part Number Numéro Pièce	Rev.	6
	9500U2D725418B	0	17

This drawing is confidential and must not be reproduced or used without the consent of EXM

Ce dessin est confidentiel et ne doit pas être reproduit ou utilisé sans le consentement de EXM

STANDARD FEATURES ARE NOT LISTED IN THIS HOLE TABLE

HOLE TABLE - BACK VIEW (CUSTOM FEATURE ONLY)

CUT-OUT	XDIM	YDIM	DESCRIPTION
1	3.661	8.786	IP STUD M10 x 40mm (Inside)
2	49.911	8.786	IP STUD M10 x 40mm (Inside)
3	3.661	37.911	IP STUD M10 x 40mm (Inside)
4	49.911	37.911	IP STUD M10 x 40mm (Inside)
5	3.661	67.036	IP STUD M10 x 40mm (Inside)
6	49.911	67.036	IP STUD M10 x 40mm (Inside)
7	26.786	8.786	IP STUD M10 x 40mm (Inside)
8	26.786	67.036	IP STUD M10 x 40mm (Inside)
-----	-----	-----	-----
9	47.786	7.411	IP SUPPORT ANGLE (Inside)
10	5.786	7.411	IP SUPPORT ANGLE (Inside)

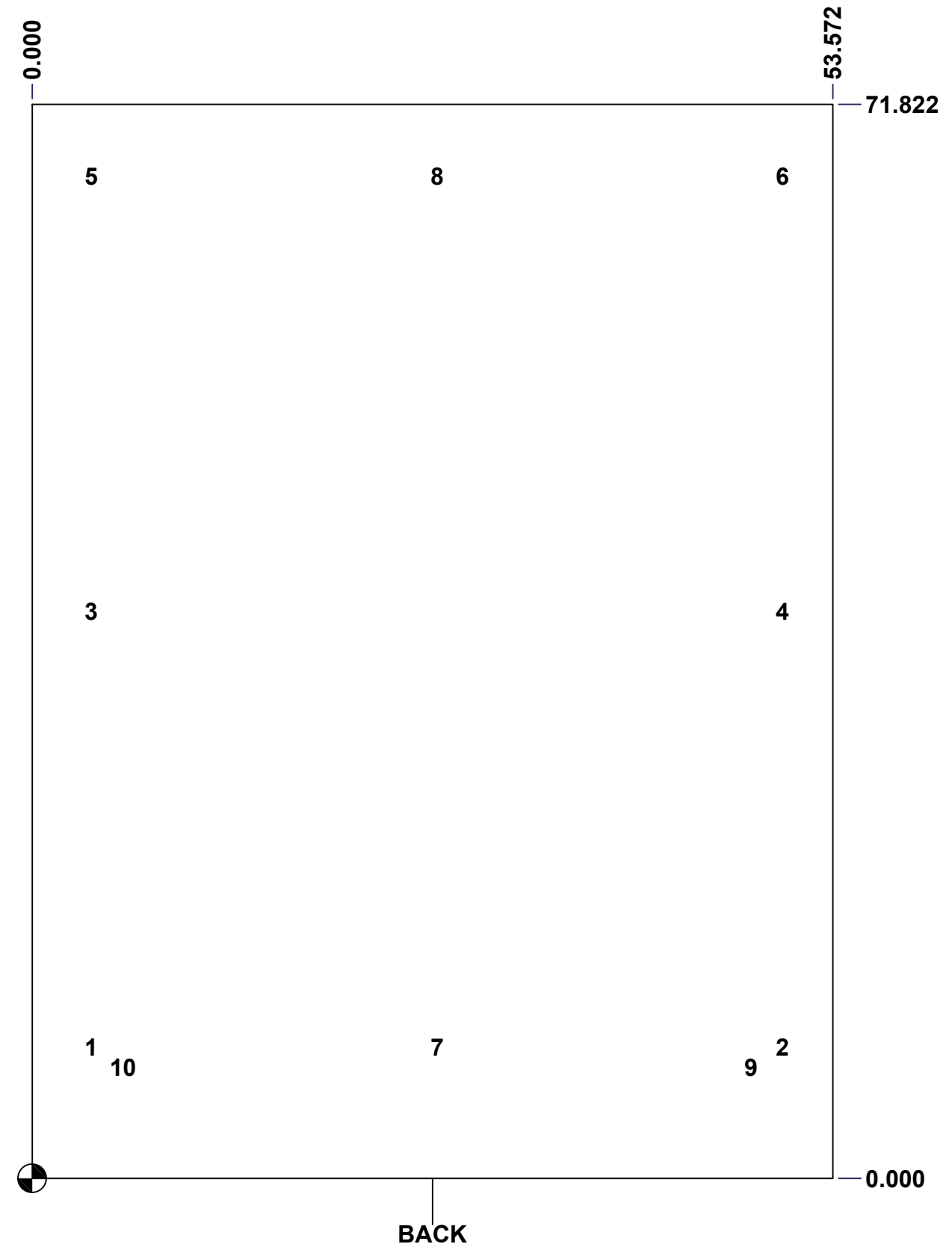

	Description		Status
	9500U2D 72" x 53.75" x 18" Body		(NULL)
Part Number Numéro Pièce		Rev.	7
9500U2D725418B		0	17

This drawing is confidential and must not be reproduced or used without the consent of EXM

Ce dessin est confidentiel et ne doit pas être reproduit ou utilisé sans le consentement de EXM

STANDARD FEATURES ARE NOT LISTED IN THIS HOLE TABLE			
HOLE TABLE - CENTER VIEW (CUSTOM FEATURE ONLY)			
CUT-OUT	XDIM	YDIM	DESCRIPTION
1	0.748	39.220	INTERLOCK STUD M6 x 16mm (Inside)
2	0.748	41.346	INTERLOCK STUD M6 x 16mm (Inside)
3	2.717	39.220	INTERLOCK STUD M6 x 16mm (Inside)
4	2.717	41.346	INTERLOCK STUD M6 x 16mm (Inside)
5	1.732	3.648	GND STUD M6 x 16mm (Inside)

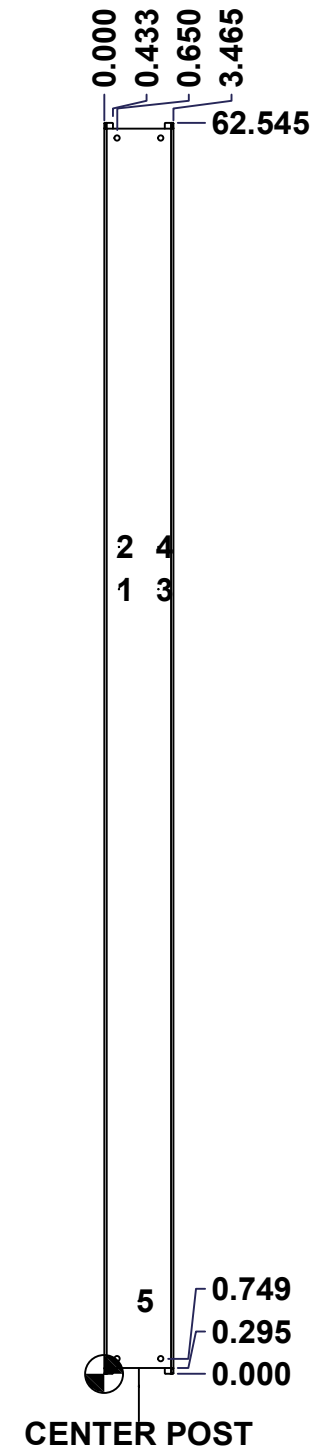

	Description	Status	
	9500U2D 72" x 53.75" x 18" Body	(NULL)	
	Part Number	Rev.	8
	Numéro Pièce	0	17
9500U2D725418B			

This drawing is confidential and must not be reproduced or used without the consent of EXM

Ce dessin est confidentiel et ne doit pas être reproduit ou utilisé sans le consentement de EXM

No.	Revisions	Date	By/Par

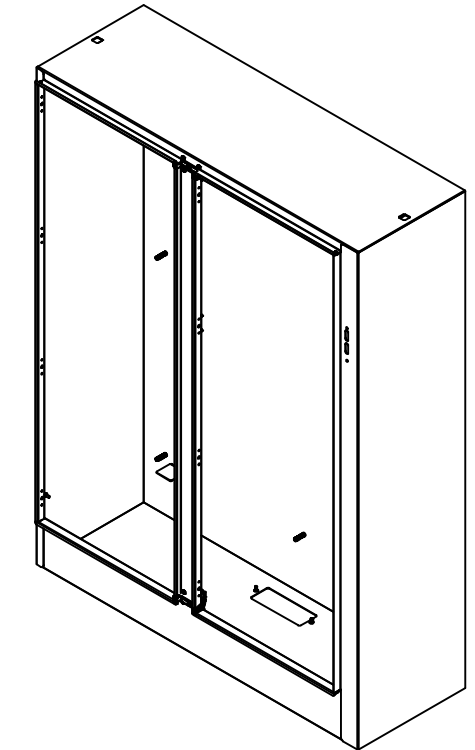

Isometric View



6	STK-Q-16030	0	Stud M6 x 10mm Steel
6	STK-Q-07220	1	M6 Nylon Insert Lock Nut
2	9500U2D725418BPA-P	0	9500U2D Inner Panel Support Angle
2	STK-Q-74900	0	Eyebolt Lifting Angle (8.750")
1	STK-P-02400S	0	Powder Paint (Asa-61 Grey / Smooth)
4	STK-Q-16055	1	M6 x 18mm Stud (No Paint Cap Required)
1	STK-A-75454	3	Center Post - Sealing Block with Latch Assembly (Large)
1	9500U2D725418CP-P	0	9500U2D 72" Center Post Part
8	STK-Q-16100	0	Stud M10 x 40mm Steel
1	9500U2D725418BT-P	0	9500U2D 53.75" x 18" Bottom Part
1	9500U2D725418T-P	0	9500U2D 53.75" x 18" Top Part
1	9500U2D725418RS-P	0	9500U2D 72" x 53.75" Right Part
1	9500U2D725418LS-P	0	9500U2D 72" x 53.75" Left Part
1	9500U2D725418B-P	0	9500U2D 72" x 53.75" Back Part
2	CR400MS_21.5	0	Commercial Roll Mild Steel (21.5in long)
4	STK-Q-16080	0	Ground Stud M6 x 16mm Steel

Qty	Part Number	Rev	Description
Parts List			

Tél: (450) 979-4373 Fax: (450) 979-4626 www.exmweb.com	Flatness Aplatissement
	Max 3.0mm
Projection	
Customer Client	Date
Drawn By Dessiné Par	Date 19-Apr-16
Material Matière	12 Ga Cold Rolled A1008 CS Type B (2.5mm)
Color Couleur	Asa-61 Grey
Finish Fini	Smooth
Description	Detail Rev.
9500U2D 72" x 53.75" x 18" Body	
Part Number Numéro Pièce	Rev. 9
9500U2D725418B	0

This drawing is confidential and must not be reproduced or used without the consent of EXM

Ce dessin est confidentiel et ne doit pas être reproduit ou utilisé sans le consentement de EXM



TOP

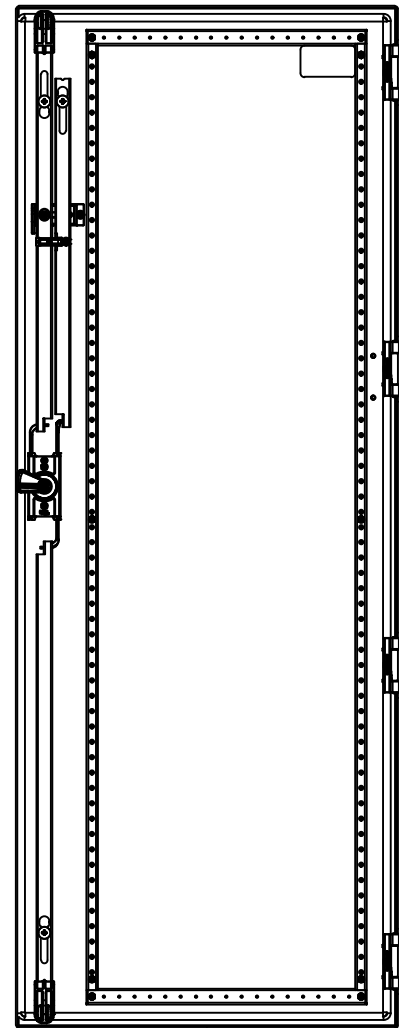

BACK



BOTTOM

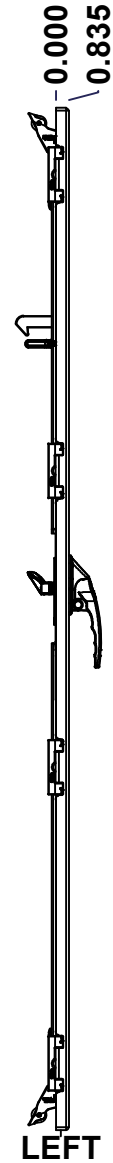

LEFT

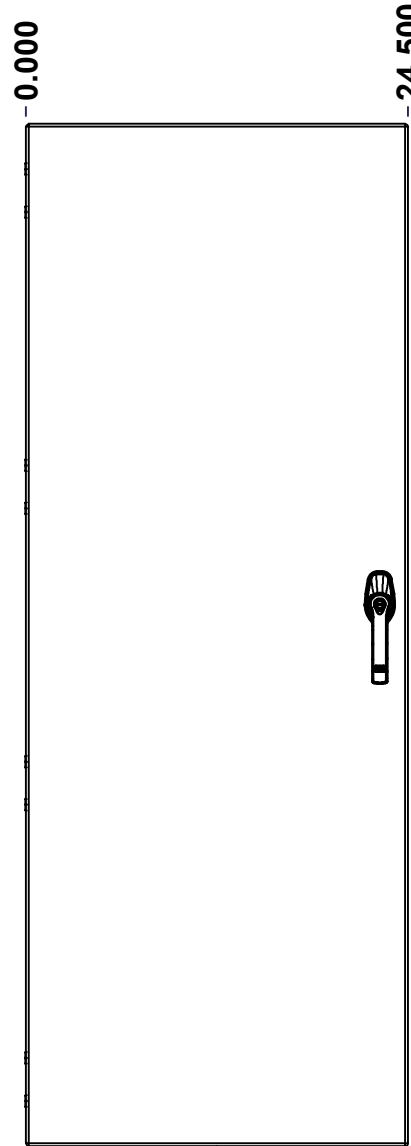

FRONT

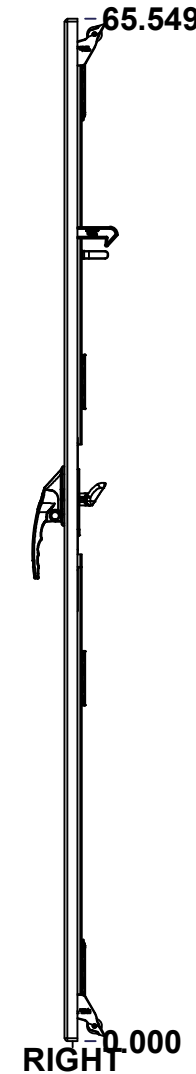

RIGHT

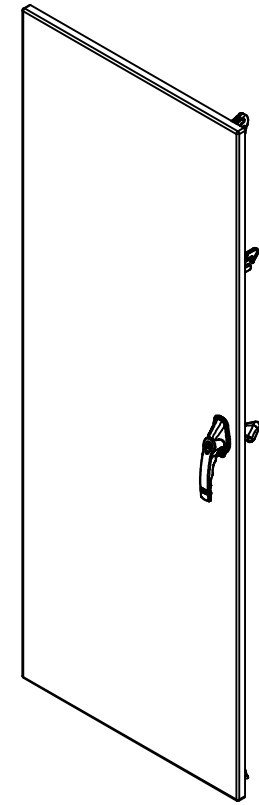

Isometric View

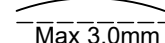
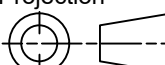

No.	Revisions	Date	By/Par

 Tél: (450) 979-4373 Fax: (450) 979-4626 www.exmweb.com		Flatness Aplatissement  Max 3.0mm Projection 
Customer Client	Date	
Drawn By Dessiné Par	BoxCad: BoxCad	Date 19-Apr-16
Material Matière	12 Ga Cold Rolled A1008 CS Type B (2.5mm)	
Color Couleur	Asa-61 Grey	Finish Fini Smooth
Description	Detail Rev.	
9500U2D 72" x 53.75" Lock Door		
Part Number Numéro Pièce	Rev.	10
9500U2D725418LD	0	17

SEE BILL OF MATERIAL ON LAST PAGE

This drawing is confidential and must not be reproduced or used without the consent of EXM

Ce dessin est confidentiel et ne doit pas être reproduit ou utilisé sans le consentement de EXM

STANDARD FEATURES ARE NOT LISTED IN THIS HOLE TABLE			
HOLE TABLE - FRONT VIEW (CUSTOM FEATURE ONLY)			
CUT-OUT	XDIM	YDIM	DESCRIPTION
1	2.375	2.028	STUD M6 x 18mm (Inside)
2	2.375	32.628	STUD M6 x 18mm (Inside)
3	2.375	63.521	STUD M6 x 18mm (Inside)
4	2.375	3.139	STUD M6 x 18mm (Inside)
5	2.375	62.409	STUD M6 x 18mm (Inside)
6	19.626	2.028	STUD M6 x 18mm (Inside)
7	19.626	32.628	STUD M6 x 18mm (Inside)
8	19.626	63.521	STUD M6 x 18mm (Inside)
9	19.626	3.139	STUD M6 x 18mm (Inside)
10	19.626	62.409	STUD M6 x 18mm (Inside)
11	22.688	6.118	CLOSING BAR STUD (Inside)
12	22.688	59.430	CLOSING BAR STUD (Inside)
13	21.501	59.430	STUD M6 x 18mm (Inside)
14	21.501	52.149	STUD M6 x 18mm (Inside)
15	22.688	52.149	STUD M6 x 18mm (Inside)

16	22.688	34.743	HANDLE 885 ESL2A-APHD @ 0.0°
17	1.604	40.445	STUDS M6 x 18mm (Inside)
18	1.604	43.123	STUDS M6 x 18mm (Inside)

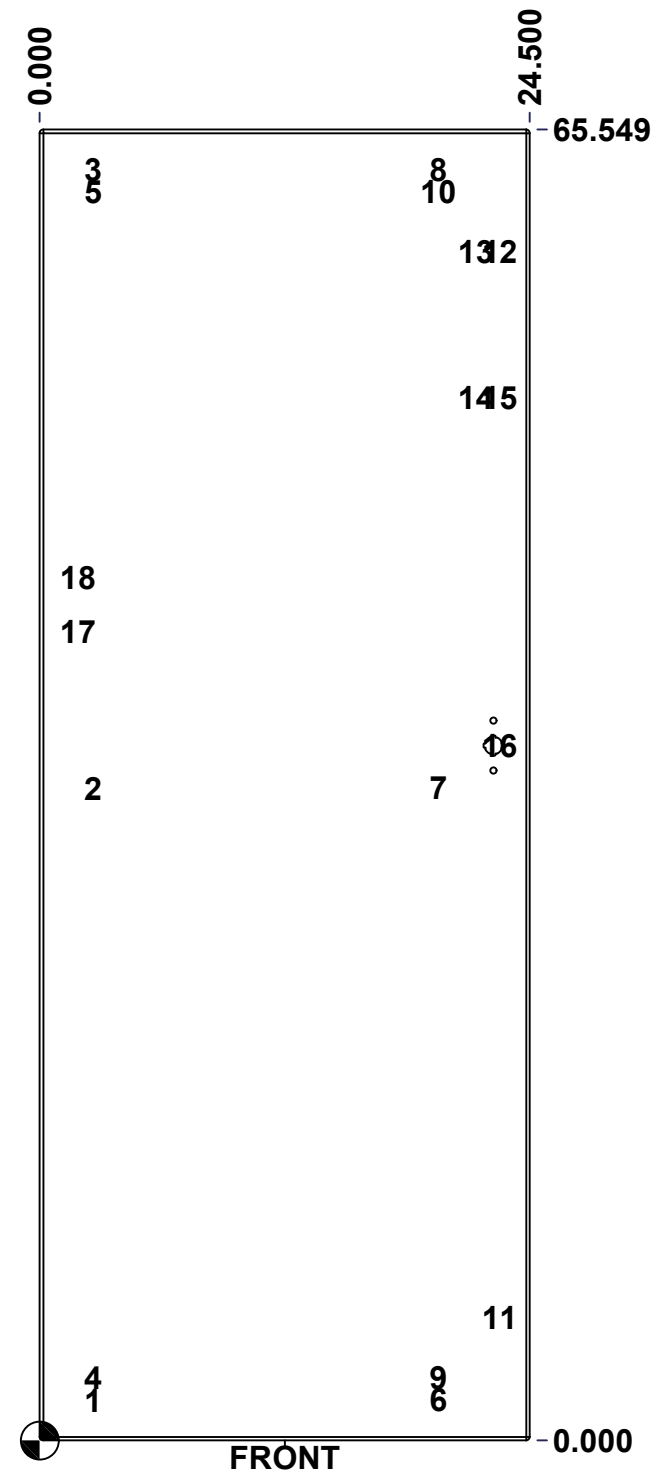

	Description	Status
	9500U2D 72" x 53.75" Lock Door	(NULL)
	Part Number Numéro Pièce	Rev.
	9500U2D725418LD	0
		11
		17

This drawing is confidential and must not be reproduced or used without the consent of EXM

Ce dessin est confidentiel et ne doit pas être reproduit ou utilisé sans le consentement de EXM

No.	Revisions	Date	By/Par

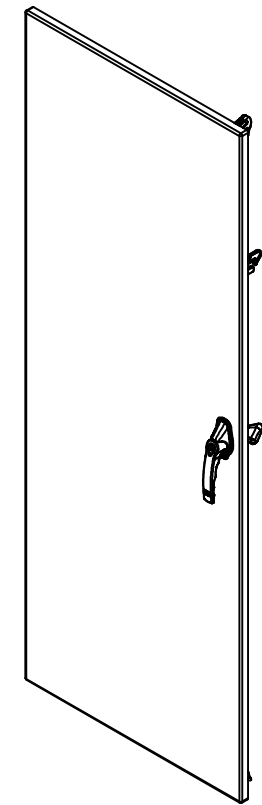

Isometric View



2	STK-Q-16050	1	Stud M6 x 18mm Steel
1	9500U2D725418DB_ESY	0	9500U2D 72" Disconnect Defeater Bar
1	9500U2D725418CB	0	9500U2D 72" Closing Bar
1	9500U2D725418CB_ESY	0	9500U2D 72" Disconnect Closing Bar
1	STK-K-03895-36	3	Gearbox Clockwise Assembly (Grip 36mm)
1	885ESL2A-APHD	0	885 ESL2A-APHD - Zinc Die Cast L-Handle Padlockable Assy - Slot Cylinder
1	STK-P-02400S	0	Powder Paint (Asa-61 Grey / Smooth)
1	STK-S-00100	0	3.5" x 2" Silver Milar Flexcon Sticker
1	STK-Q-03200	0	M6 x 8mm Hexagon/Slot Screw
1	STK-Q-07220	1	M6 Nylon Insert Lock Nut
1	STK-Q-13060	1	M6 Flat Washer
1	STK-Q-46600	3	5500 ESY Disconnect Door Hook
1	9500U2D725418DS1	0	9500U2D 72" x 53.75" Door Stiffener
15	STK-Q-16055	1	M6 x 18mm Stud (No Paint Cap Required)
1	9500U2D725418LDG	0	9500U2D 72" x 53.75" Lock Door Gasket
1	9500U2D725418LD-P	0	9500U2D 72" x 53.75" Lock Door Part
4	STK-K-09860	7	Cabinet Hinge with Captive Pins

QTY	Part Number	Rev	Description
Parts List			

Tél: (450) 979-4373 Fax: (450) 979-4626 www.exmweb.com	Flatness Aplatissement	Max 3.0mm
	Projection	
Customer Client	Date	
Drawn By Dessiné Par	BoxCad: BoxCad	Date 19-Apr-16
Material Matière	12 Ga Cold Rolled A1008 CS Type B (2.5mm)	
Color Couleur	Asa-61 Grey	Finish Fini Smooth
Description	Detail Rev.	
9500U2D 72" x 53.75" Lock Door		
Part Number Numéro Pièce	Rev.	12
9500U2D725418LD	0	17

This drawing is confidential and must not be reproduced or used without the consent of EXM

Ce dessin est confidentiel et ne doit pas être reproduit ou utilisé sans le consentement de EXM

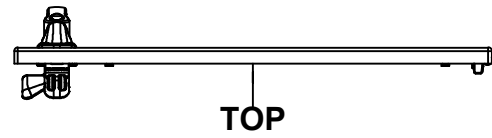

TOP

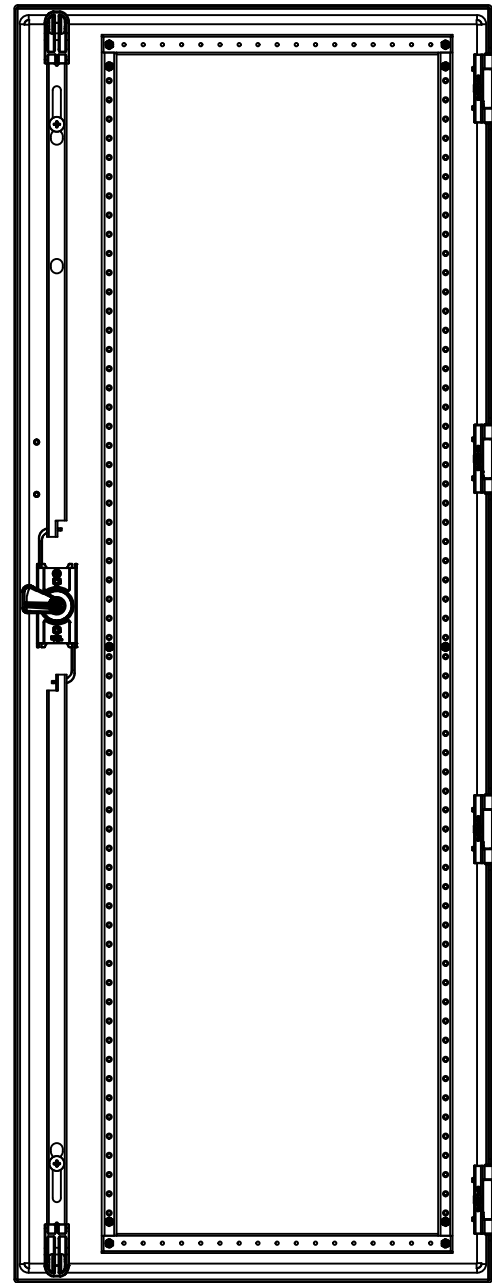

BACK



BOTTOM

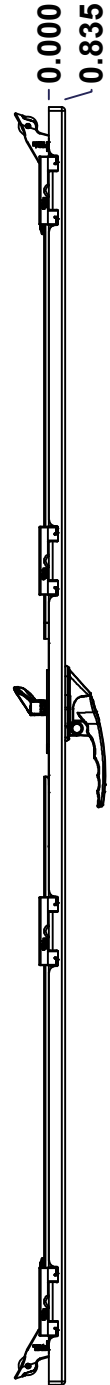

LEFT

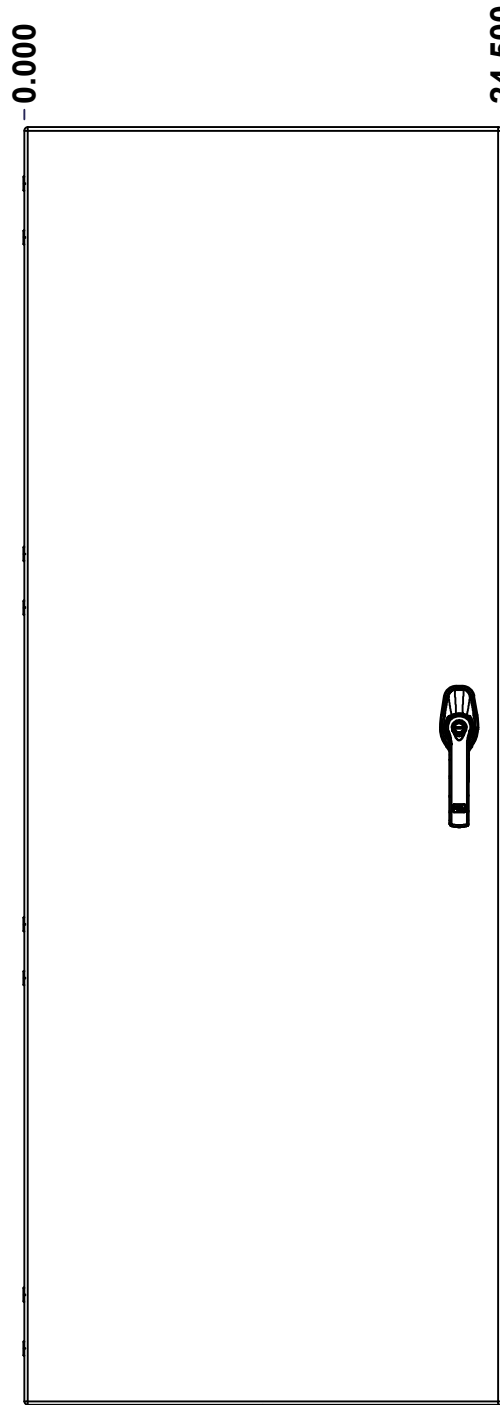

FRONT

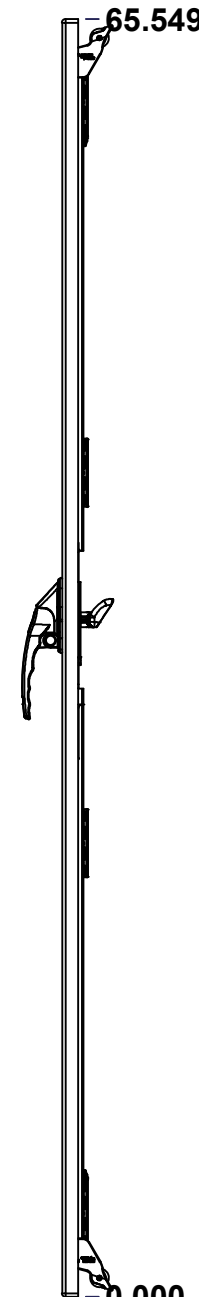

RIGHT

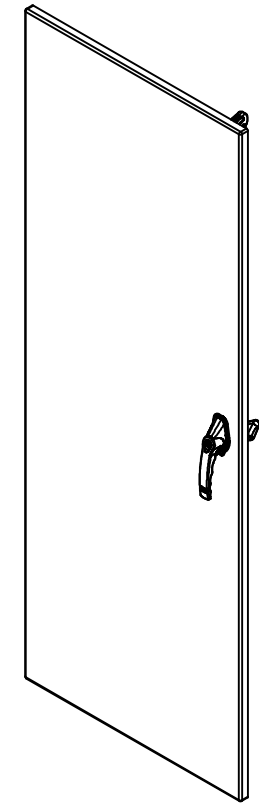

Isometric View

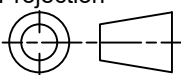

No.	Revisions	Date	By/Par

 Tél: (450) 979-4373 Fax: (450) 979-4626 www.exmweb.com		Flatness Aplatissement Max 3.0mm Projection 
Customer Client	Date	
Drawn By Dessiné Par	BoxCad: BoxCad	Date 19-Apr-16
Material Matière	12 Ga Cold Rolled A1008 CS Type B (2.5mm)	
Color Couleur	Asa-61 Grey	Finish Fini Smooth
Description 9500U2D 72" x 53.75" Lock Door		Detail Rev.
Part Number Numéro Pièce	Rev. 0	13 / 17

SEE BILL OF MATERIAL ON LAST PAGE

9500U2D725418FD

This drawing is confidential and must not be reproduced or used without the consent of EXM

Ce dessin est confidentiel et ne doit pas être reproduit ou utilisé sans le consentement de EXM

STANDARD FEATURES ARE NOT LISTED IN THIS HOLE TABLE			
HOLE TABLE - FRONT VIEW (CUSTOM FEATURE ONLY)			
CUT-OUT	XDIM	YDIM	DESCRIPTION
1	2.375	2.028	STUD M6 x 18mm (Inside)
2	2.375	32.628	STUD M6 x 18mm (Inside)
3	2.375	63.521	STUD M6 x 18mm (Inside)
4	2.375	3.139	STUD M6 x 18mm (Inside)
5	2.375	62.409	STUD M6 x 18mm (Inside)
6	19.626	2.028	STUD M6 x 18mm (Inside)
7	19.626	32.628	STUD M6 x 18mm (Inside)
8	19.626	63.521	STUD M6 x 18mm (Inside)
9	19.626	3.139	STUD M6 x 18mm (Inside)
10	19.626	62.409	STUD M6 x 18mm (Inside)
11	22.313	6.118	CLOSING BAR STUD (Inside)
12	22.313	59.430	CLOSING BAR STUD (Inside)

13	22.312	34.743	HANDLE 885 ESL2A-APHD @ 0.0°
14	23.348	40.445	STUDS M6 x 18mm (Inside)
15	23.348	43.123	STUDS M6 x 18mm (Inside)

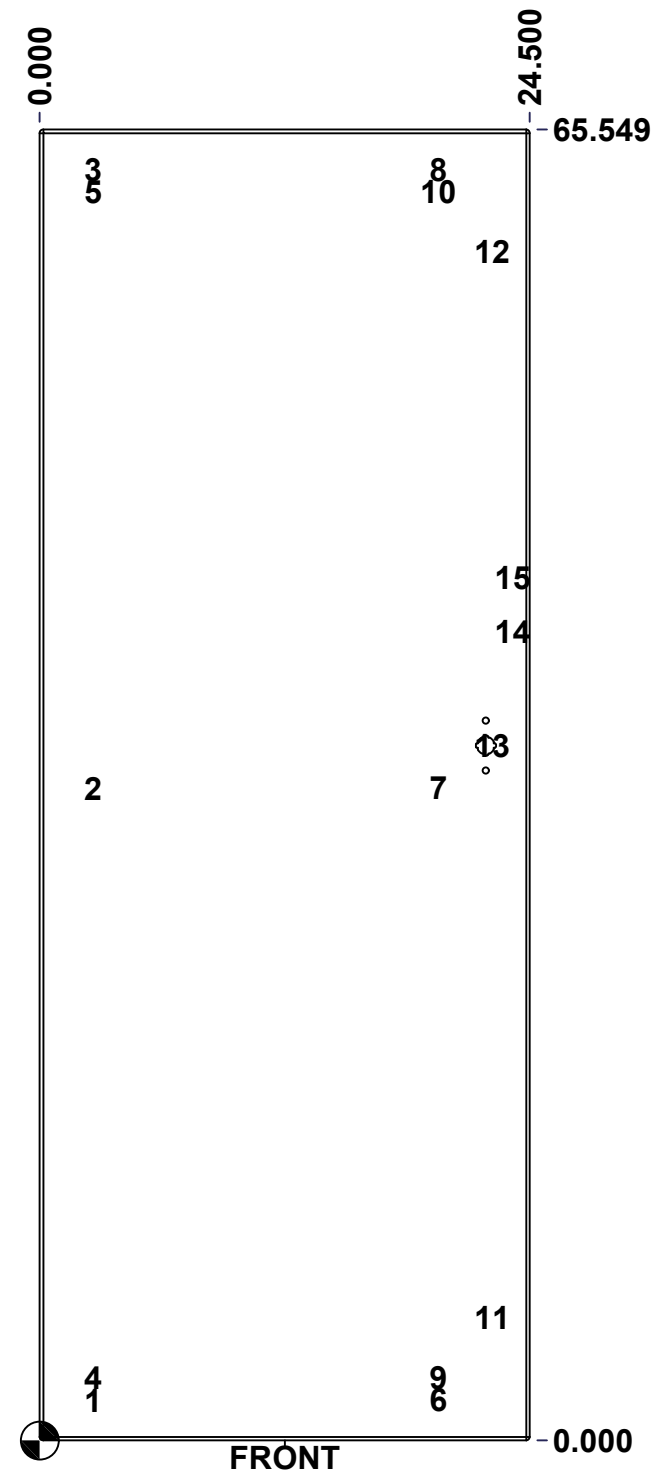

	Description	Status	
	9500U2D 72" x 53.75" Lock Door	(NULL)	
	Part Number Numéro Pièce	Rev.	14
	9500U2D725418FD	0	17

This drawing is confidential and must not be reproduced or used without the consent of EXM

Ce dessin est confidentiel et ne doit pas être reproduit ou utilisé sans le consentement de EXM

No.	Revisions	Date	By/Par

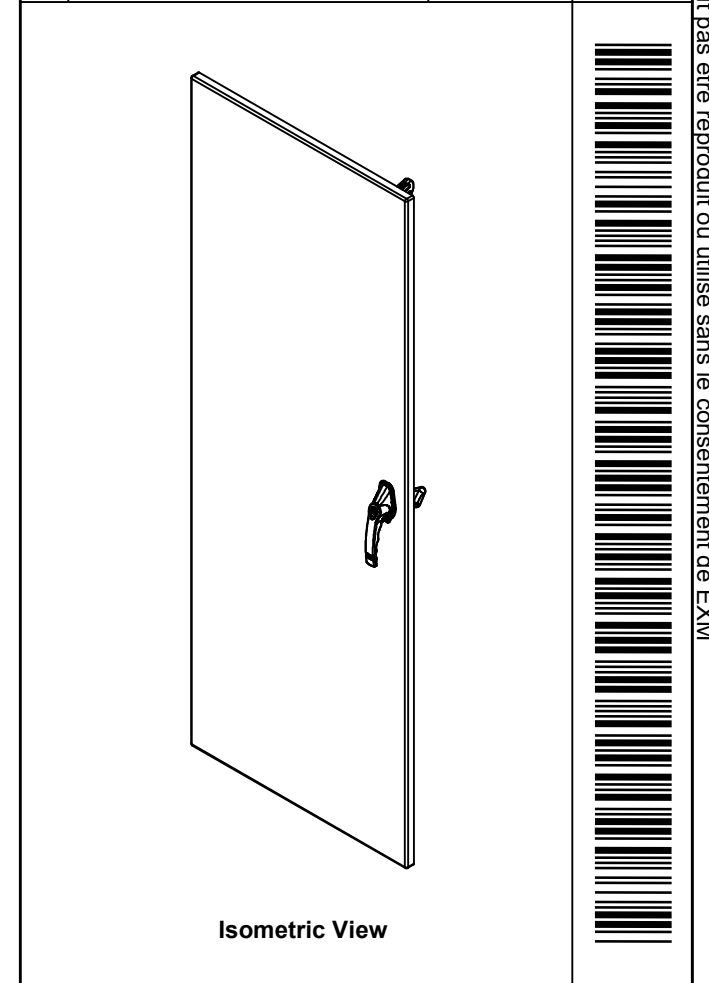

EXM
www.exmweb.com

Tél: (450) 979-4373
Fax: (450) 979-4626

Flatness
Aplatissement
Max 3.0mm

Projection

2	STK-Q-16050	1	Stud M6 x 18mm Steel
1	9500U2D725418CB	0	9500U2D 72" Closing Bar
1	9500U2D725418CB_ESY	0	9500U2D 72" Disconnect Closing Bar
1	STK-A-03880-36	12	Gearbox Clockwise Assembly (Grip 36mm)
1	885ESL2A-APHD	0	885 ESL2A-APHD - Zinc Die Cast L-Handle Padlockable Assy - Slot Cylinder
1	STK-P-02400S	0	Powder Paint (Asa-61 Grey / Smooth)
1	9500U2D725418DS1	0	9500U2D 72" x 53.75" Door Stiffener
12	STK-Q-16055	1	M6 x 18mm Stud (No Paint Cap Required)
1	9500U2D725418FDG	0	9500U2D 72" x 53.75" Flange Door Gasket
1	9500U2D725418FD-P	0	9500U2D 72" x 53.75" Lock Door Part
4	STK-K-09860	7	Cabinet Hinge with Captive Pins
QTY	Part Number	Rev	Description
Parts List			

Customer Client	Date
Drawn By Dessiné Par	Date 19-Apr-16
Material Matière	BoxCad: BoxCad
Color Couleur	12 Ga Cold Rolled A1008 CS Type B (2.5mm)
Asa-61 Grey	Finish Fini
Smooth	Detail Rev.
Description	9500U2D 72" x 53.75" Lock Door
Part Number Numéro Pièce	Rev. 15
9500U2D725418FD	0 17

This drawing is confidential and must not be reproduced or used without the consent of EXM

Ce dessin est confidentiel et ne doit pas être reproduit ou utilisé sans le consentement de EXM

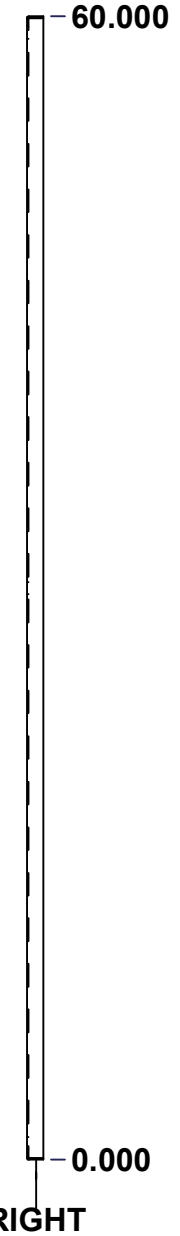
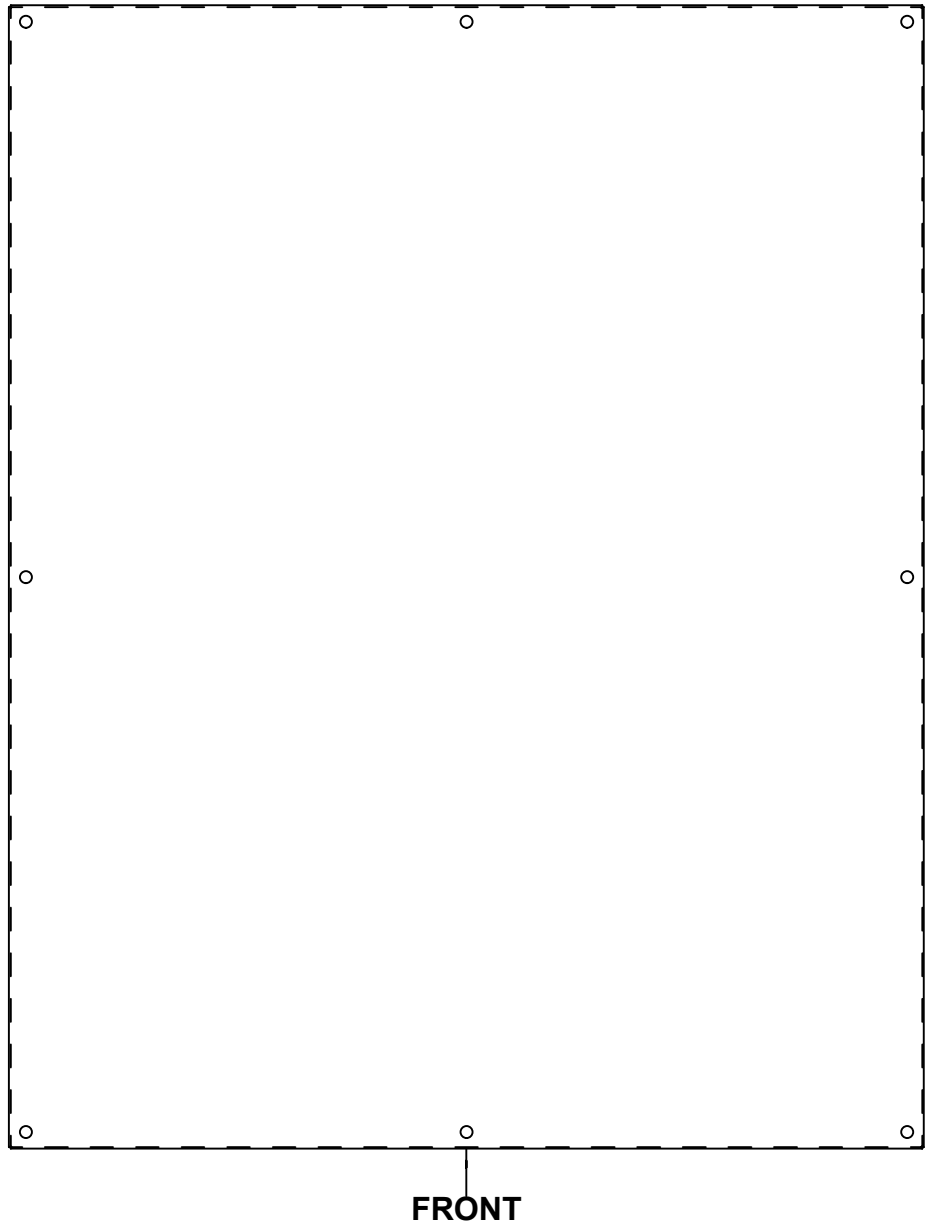
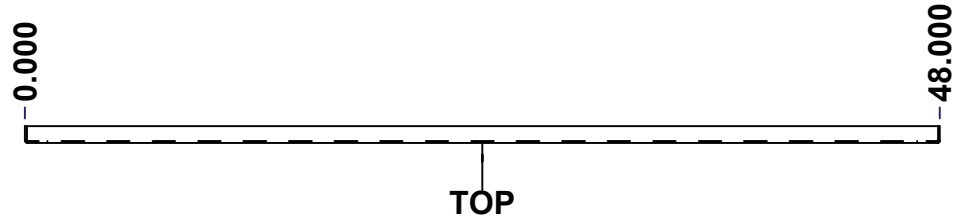

No.	Revisions	Date	By/Par

Isometric View

Tél: (450) 979-4373 Fax: (450) 979-4626 www.exmweb.com		Flatness Aplatissement	
		Max 3.0mm	
Customer Client		Date	
Drawn By Dessiné Par		Date	
Material Matière		Date	
Color Couleur		Finish Fini	
Description		Detail Rev.	
Part Number Numéro Pièce		Rev.	

BoxCad: BoxCad 19-Apr-16

12 Ga Galvanized (2.5mm)

Unpainted Unpainted

9500U2D 72" x 53.75" Inner Panel

9500U2D725418IP 0 16/17

SEE BILL OF MATERIAL ON LAST PAGE

This drawing is confidential and must not be reproduced or used without the consent of EXM

Ce dessin est confidentiel et ne doit pas être reproduit ou utilisé sans le consentement de EXM

No.	Revisions	Date	By/Par

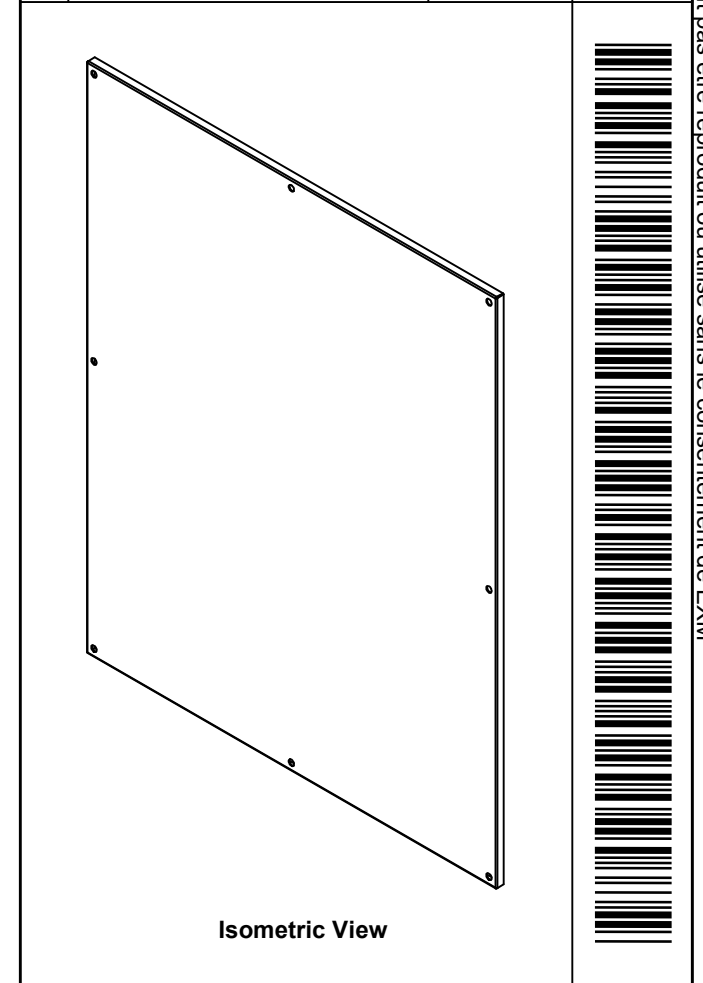

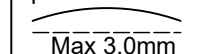
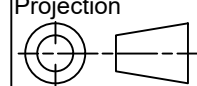
 Tél: (450) 979-4373 Fax: (450) 979-4626 www.exmweb.com		Flatness Aplatissement  Max 3.0mm
Customer Client		Projection 
Drawn By Dessiné Par BoxCad: BoxCad		Date 19-Apr-16
Material Matière 12 Ga Galvanized (2.5mm)		
Color Couleur Unpainted	Finish Fini Unpainted	
Description 9500U2D 72" x 53.75" Inner Panel		Detail Rev.
Part Number Numéro Pièce 9500U2D725418IP	Rev. 0	17 / 17

Qty	Part Number	Rev	Description
1	9500U2D725418IP-P	0	9500U2D 72" x 53.75" Inner Panel Part
Parts List			